

# MicroBlaze Processor Reference Guide

*Embedded Development Kit  
EDK 14.7*

UG081 (v14.7)



### Notice of Disclaimer

The information disclosed to you hereunder (the "Materials") is provided solely for the selection and use of Xilinx products. To the maximum extent permitted by applicable law: (1) Materials are made available "AS IS" and with all faults, Xilinx hereby DISCLAIMS ALL WARRANTIES AND CONDITIONS, EXPRESS, IMPLIED, OR STATUTORY, INCLUDING BUT NOT LIMITED TO WARRANTIES OF MERCHANTABILITY, NON-INFRINGEMENT, OR FITNESS FOR ANY PARTICULAR PURPOSE; and (2) Xilinx shall not be liable (whether in contract or tort, including negligence, or under any other theory of liability) for any loss or damage of any kind or nature related to, arising under, or in connection with, the Materials (including your use of the Materials), including for any direct, indirect, special, incidental, or consequential loss or damage (including loss of data, profits, goodwill, or any type of loss or damage suffered as a result of any action brought by a third party) even if such damage or loss was reasonably foreseeable or Xilinx had been advised of the possibility of the same. Xilinx assumes no obligation to correct any errors contained in the Materials or to notify you of updates to the Materials or to product specifications. You may not reproduce, modify, distribute, or publicly display the Materials without prior written consent. Certain products are subject to the terms and conditions of the Limited Warranties which can be viewed at <http://www.xilinx.com/warranty.htm>; IP cores may be subject to warranty and support terms contained in a license issued to you by Xilinx. Xilinx products are not designed or intended to be fail-safe or for use in any application requiring fail-safe performance; you assume sole risk and liability for use of Xilinx products in Critical Applications: <http://www.xilinx.com/warranty.htm#critapps>.

### Automotive Applications Disclaimer

XILINX PRODUCTS ARE NOT DESIGNED OR INTENDED TO BE FAIL-SAFE, OR FOR USE IN ANY APPLICATION REQUIRING FAIL-SAFE PERFORMANCE, SUCH AS APPLICATIONS RELATED TO: (I) THE DEPLOYMENT OF AIRBAGS, (II) CONTROL OF A VEHICLE, UNLESS THERE IS A FAIL-SAFE OR REDUNDANCY FEATURE (WHICH DOES NOT INCLUDE USE OF SOFTWARE IN THE XILINX DEVICE TO IMPLEMENT THE REDUNDANCY) AND A WARNING SIGNAL UPON FAILURE TO THE OPERATOR, OR (III) USES THAT COULD LEAD TO DEATH OR PERSONAL INJURY. CUSTOMER ASSUMES THE SOLE RISK AND LIABILITY OF ANY USE OF XILINX PRODUCTS IN SUCH APPLICATIONS.

© 2002 – 2013 Xilinx, Inc. Xilinx, the Xilinx logo, Artix, ISE, Kintex, Spartan, Virtex, Zynq, and other designated brands included herein are trademarks of Xilinx in the United States and other countries. All other trademarks are the property of their respective owners. AMBA, AMBA Designer, ARM, ARM1176JZ-S, CoreSight, Cortex, and PrimeCell are trademarks of ARM in the EU and other countries.

## Revision History

The following table shows the revision history for this document.

Date	Version	Revision
10/01/02	1.0	Xilinx EDK 3.1 release
03/11/03	2.0	Xilinx EDK 3.2 release
09/24/03	3.0	Xilinx EDK 6.1 release
02/20/04	3.1	Xilinx EDK 6.2 release
08/24/04	4.0	Xilinx EDK 6.3 release
09/21/04	4.1	Minor corrections for EDK 6.3 SP1 release
11/18/04	4.2	Minor corrections for EDK 6.3 SP2 release
01/20/05	5.0	Xilinx EDK 7.1 release
04/02/05	5.1	Minor corrections for EDK 7.1 SP1 release
05/09/05	5.2	Minor corrections for EDK 7.1 SP2 release
10/05/05	5.3	Minor corrections for EDK 8.1 release
02/21/06	5.4	Corrections for EDK 8.1 SP2 release
06/01/06	6.0	Xilinx EDK 8.2 release

<b>Date</b>	<b>Version</b>	<b>Revision</b>
07/24/06	6.1	Minor corrections for EDK 8.2 SP1 release
08/21/06	6.2	Minor corrections for EDK 8.2 SP2 release
08/29/06	6.3	Minor corrections for EDK 8.2 SP2 release
09/15/06	7.0	Xilinx EDK 9.1 release
02/22/07	7.1	Minor corrections for EDK 9.1 SP1 release
03/27/07	7.2	Minor corrections for EDK 9.1 SP2 release
06/25/07	8.0	Xilinx EDK 9.2 release
10/12/07	8.1	Minor corrections for EDK 9.2 SP2 release
01/17/08	9.0	Xilinx EDK 10.1 release
03/04/08	9.1	Minor corrections for EDK 10.1 SP1 release
05/14/08	9.2	Minor corrections for EDK 10.1 SP2 release
07/14/08	9.3	Minor corrections for EDK 10.1 SP3 release
02/04/09	10.0	Xilinx EDK 11.1 release
04/15/09	10.1	Xilinx EDK 11.2 release
05/28/09	10.2	Xilinx EDK 11.3 release
10/26/09	10.3	Xilinx EDK 11.4 release
04/19/10	11.0	Xilinx EDK 12.1 release
07/23/10	11.1	Xilinx EDK 12.2 release
09/21/10	11.2	Xilinx EDK 12.3 release
11/15/10	11.3	Minor corrections for EDK 12.4 release
11/15/10	11.4	Xilinx EDK 12.4 release
03/01/11	12.0	Xilinx EDK 13.1 release
06/22/11	13.2	Xilinx EDK 13.2 release
10/19/11	13.3	Xilinx EDK 13.3 release
01/18/12	13.4	Xilinx EDK 13.4 release
04/24/12	14.1	Xilinx EDK 14.1 release
07/25/12	14.2	Xilinx EDK 14.2 release
10/16/12	14.3	Xilinx EDK 14.3 release
12/18/12	14.4	Minor corrections for Xilinx EDK 14.4 release
03/20/13	14.5	EDK 14.5 release
06/19/13	14.6	EDK 14.6 release
10/02/13	14.7	EDK 14.7 release



# Table of Contents

Revision History .....	2
<b>Chapter 1: Introduction</b>	
Guide Contents .....	7
<b>Chapter 2: MicroBlaze Architecture</b>	
Overview .....	9
Data Types and Endianness .....	13
Instructions .....	14
Registers .....	25
Pipeline Architecture .....	51
Memory Architecture .....	54
Privileged Instructions .....	55
Virtual-Memory Management .....	56
Reset, Interrupts, Exceptions, and Break .....	66
Instruction Cache .....	73
Data Cache .....	75
Floating Point Unit (FPU) .....	80
Stream Link Interfaces .....	84
Debug and Trace .....	85
Fault Tolerance .....	86
Lockstep Operation .....	92
<b>Chapter 3: MicroBlaze Signal Interface Description</b>	
Overview .....	95
MicroBlaze I/O Overview .....	96
AXI4 and ACE Interface Description .....	108
Processor Local Bus (PLB) Interface Description .....	111
Local Memory Bus (LMB) Interface Description .....	112
Fast Simplex Link (FSL) Interface Description .....	121
Xilinx CacheLink (XCL) Interface Description .....	123
Lockstep Interface Description .....	128
Debug Interface Description .....	135
Trace Interface Description .....	135
MicroBlaze Core Configurability .....	138
<b>Chapter 4: MicroBlaze Application Binary Interface</b>	
Data Types .....	151

<b>Register Usage Conventions</b> .....	152
<b>Stack Convention</b> .....	153
<b>Memory Model</b> .....	155
<b>Interrupt and Exception Handling</b> .....	156

## **Chapter 5: MicroBlaze Instruction Set Architecture**

<b>Notation</b> .....	159
<b>Formats</b> .....	161
<b>Instructions</b> .....	161

## **Appendix A: Additional Resources**

<b>EDK Documentation</b> .....	261
<b>Additional Resources</b> .....	261

# *Introduction*

---

The MicroBlaze™ Processor Reference Guide provides information about the 32-bit soft processor, MicroBlaze, which is part of the Embedded Processor Development Kit (EDK). The document is intended as a guide to the MicroBlaze hardware architecture.

## **Guide Contents**

This guide contains the following chapters:

- [Chapter 2, MicroBlaze Architecture](#), contains an overview of MicroBlaze features as well as information on Big-Endian and Little-Endian bit-reversed format, 32-bit general purpose registers, cache software support, and Fast Simplex Link interfaces.
- [Chapter 3, MicroBlaze Signal Interface Description](#), describes the types of signal interfaces that can be used to connect MicroBlaze.
- [Chapter 4, MicroBlaze Application Binary Interface](#), describes the Application Binary Interface important for developing software in assembly language for the soft processor.
- [Chapter 5, MicroBlaze Instruction Set Architecture](#), provides notation, formats, and instructions for the Instruction Set Architecture of MicroBlaze.
- [Appendix A, Additional Resources](#), provides links to EDK documentation and additional resources.





# MicroBlaze Architecture

This chapter contains an overview of MicroBlaze™ features and detailed information on MicroBlaze architecture including Big-Endian or Little-Endian bit-reversed format, 32-bit general purpose registers, virtual-memory management, cache software support, and Fast Simplex Link (FSL) or AXI4-Stream interfaces.

## Overview

The MicroBlaze™ embedded processor soft core is a reduced instruction set computer (RISC) optimized for implementation in Xilinx® Field Programmable Gate Arrays (FPGAs). Figure 2-1 shows a functional block diagram of the MicroBlaze core.

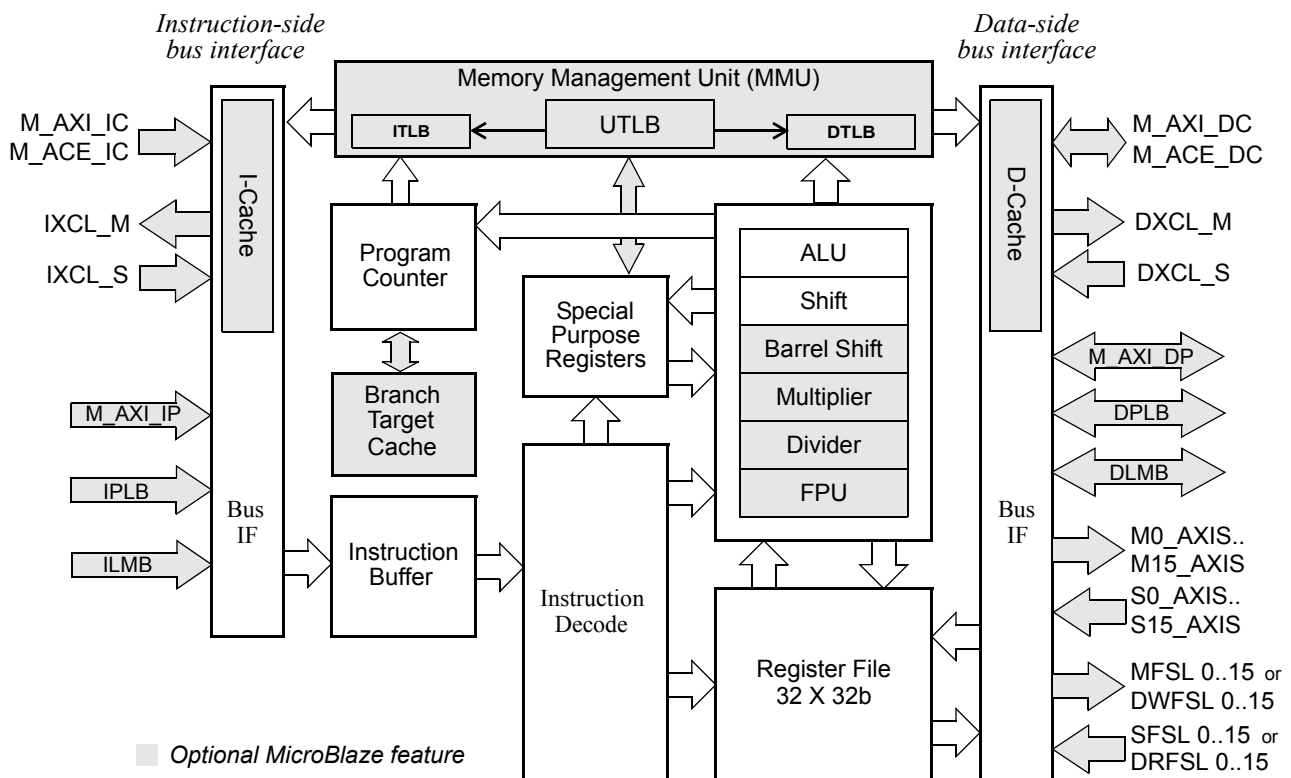

Figure 2-1: MicroBlaze Core Block Diagram

## Features

The MicroBlaze soft core processor is highly configurable, allowing you to select a specific set of features required by your design.

The fixed feature set of the processor includes:

- Thirty-two 32-bit general purpose registers
- 32-bit instruction word with three operands and two addressing modes
- 32-bit address bus
- Single issue pipeline

In addition to these fixed features, the MicroBlaze processor is parameterized to allow selective enabling of additional functionality. Older (deprecated) versions of MicroBlaze support a subset of the optional features described in this manual. Only the latest (preferred) version of MicroBlaze (v8.00) supports all options.

Xilinx recommends that all new designs use the latest **preferred** version of the MicroBlaze processor.

Table 2-1, page 10 provides an overview of the configurable features by MicroBlaze versions.

**Table 2-1: Configurable Feature Overview by MicroBlaze Version**

Feature	MicroBlaze Versions					
	v7.30	v8.10	v8.20	v8.30	v8.40	v8.50
Version Status	obsolete	deprecated	deprecated	deprecated	deprecated	preferred
Processor pipeline depth	3/5	3/5	3/5	3/5	3/5	3/5
On-chip Peripheral Bus (OPB) data side interface	No	No	No	No	No	No
On-chip Peripheral Bus (OPB) instruction side interface	No	No	No	No	No	No
Local Memory Bus (LMB) data side interface	option	option	option	option	option	option
Local Memory Bus (LMB) instruction side interface	option	option	option	option	option	option
Hardware barrel shifter	option	option	option	option	option	option
Hardware divider	option	option	option	option	option	option
Hardware debug logic	option	option	option	option	option	option
Stream link interfaces	0-15 FSL	0-15 FSL/AXI	0-15 FSL/AXI	0-15 FSL/AXI	0-15 FSL/AXI	0-15 FSL/AXI
Machine status set and clear instructions	option	option	option	option	option	option
Instruction cache over IOPB interface	No	No	No	No	No	No
Data cache over DOPB interface	No	No	No	No	No	No
Instruction cache over Cache Link (IXCL) interface	option	option	option	option	option	option
Data cache over Cache Link (DXCL) interface	option	option	option	option	option	option
4 or 8-word cache line	option	option	option	option	option	option

**Table 2-1: Configurable Feature Overview by MicroBlaze Version**

Feature	MicroBlaze Versions					
	v7.30	v8.10	v8.20	v8.30	v8.40	v8.50
Hardware exception support	option	option	option	option	option	option
Pattern compare instructions	option	option	option	option	option	option
Floating point unit (FPU)	option	option	option	option	option	option
Disable hardware multiplier <sup>1</sup>	option	option	option	option	option	option
Hardware debug readable ESR and EAR	Yes	Yes	Yes	Yes	Yes	Yes
Processor Version Register (PVR)	option	option	option	option	option	option
Area or speed optimized	option	option	option	option	option	option
Hardware multiplier 64-bit result	option	option	option	option	option	option
LUT cache memory	option	option	option	option	option	option
Processor Local Bus (PLB) data side interface	option	option	option	option	option	option
Processor Local Bus (PLB) instruction side interface	option	option	option	option	option	option
Floating point conversion and square root instructions	option	option	option	option	option	option
Memory Management Unit (MMU)	option	option	option	option	option	option
Extended stream instructions	option	option	option	option	option	option
Use Xilinx Cache Link for All I-Cache Memory Accesses	option	option	option	option	option	option
Use Xilinx Cache Link for All D-Cache Memory Accesses	option	option	option	option	option	option
Use Write-back Caching Policy for D-Cache	option	option	option	option	option	option
Cache Link (DXCL) protocol for D-Cache	option	option	option	option	option	option
Cache Link (IXCL) protocol for I-Cache	option	option	option	option	option	option
Branch Target Cache (BTC)	option	option	option	option	option	option
Streams for I-Cache	option	option	option	option	option	option
Victim handling for I-Cache	option	option	option	option	option	option
Victim handling for D-Cache	option	option	option	option	option	option
AXI4 (M_AXI_DP) data side interface	-	option	option	option	option	option
AXI4 (M_AXI_IP) instruction side interface	-	option	option	option	option	option
AXI4 (M_AXI_DC) protocol for D-Cache	-	option	option	option	option	option
AXI4 (M_AXI_IC) protocol for I-Cache	-	option	option	option	option	option
AXI4 protocol for stream accesses	-	option	option	option	option	option
Fault tolerant features	-	option	option	option	option	option
Tool selectable endianness	-	option	option	option	option	option
Force distributed RAM for cache tags	-	option	option	option	option	option

Table 2-1: Configurable Feature Overview by MicroBlaze Version

Feature	MicroBlaze Versions					
	v7.30	v8.10	v8.20	v8.30	v8.40	v8.50
Configurable cache data widths	-	option	option	option	option	option
Count Leading Zeros instruction	-	option	option	option	option	option
Memory Barrier instruction	-	Yes	Yes	Yes	Yes	Yes
Stack overflow and underflow detection	-	option	option	option	option	option
Allow stream instructions in user mode	-	option	option	option	option	option
Lockstep support			option	option	option	option
Configurable use of FPGA primitives			option	option	option	option
Low-latency interrupt mode				option	option	option
Swap instructions				option	option	option
Sleep mode and sleep instruction					Yes	Yes
Relocatable base vectors					option	option
ACE (M_ACE_DC) protocol for D-Cache						option
ACE (M_ACE_IC) protocol for I-Cache						option

1. Used in Virtex<sup>®</sup>-4 and subsequent families, for saving MUL18 and DSP48 primitives.

## Data Types and Endianness

MicroBlaze uses Big-Endian or Little-Endian format to represent data, depending on the parameter `C_ENDIANNESS`. The hardware supported data types for MicroBlaze are word, half word, and byte. When using the reversed load and store instructions LHUR, LWR, SHR and SWR, the bytes in the data are reversed, as indicated by the byte-reversed order.

The bit and byte organization for each type is shown in the following tables.

**Table 2-2: Word Data Type**

Big-Endian Byte Address	n	n+1	n+2	n+3
Big-Endian Byte Significance	MSByte			LSByte
Big-Endian Byte Order	n	n+1	n+2	n+3
Big-Endian Byte-Reversed Order	n+3	n+2	n+1	n
Little-Endian Byte Address	n+3	n+2	n+1	n
Little-Endian Byte Significance	MSByte			LSByte
Little-Endian Byte Order	n+3	n+2	n+1	n
Little-Endian Byte-Reversed Order	n	n+1	n+2	n+3
Bit Label	0			31
Bit Significance	MSBit			LSBit

**Table 2-3: Half Word Data Type**

Big-Endian Byte Address	n	n+1
Big-Endian Byte Significance	MSByte	LSByte
Big-Endian Byte Order	n	n+1
Big-Endian Byte-Reversed Order	n+1	n
Little-Endian Byte Address	n+1	n
Little-Endian Byte Significance	MSByte	LSByte
Little-Endian Byte Order	n+1	n
Little-Endian Byte-Reversed Order	n	n+1
Bit Label	0	15
Bit Significance	MSBit	LSBit

**Table 2-4: Byte Data Type**

Byte Address	n	
Bit Label	0	7
Bit Significance	MSBit	LSBit

# Instructions

## Instruction Summary

All MicroBlaze instructions are 32 bits and are defined as either Type A or Type B. Type A instructions have up to two source register operands and one destination register operand. Type B instructions have one source register and a 16-bit immediate operand (which can be extended to 32 bits by preceding the Type B instruction with an imm instruction). Type B instructions have a single destination register operand. Instructions are provided in the following functional categories: arithmetic, logical, branch, load/store, and special. [Table 2-6](#) lists the MicroBlaze instruction set. Refer to [Chapter 5, MicroBlaze Instruction Set Architecture](#) for more information on these instructions. [Table 2-5](#) describes the instruction set nomenclature used in the semantics of each instruction.

**Table 2-5: Instruction Set Nomenclature**

Symbol	Description
Ra	R0 - R31, General Purpose Register, source operand a
Rb	R0 - R31, General Purpose Register, source operand b
Rd	R0 - R31, General Purpose Register, destination operand
SPR[x]	Special Purpose Register number $x$
MSR	Machine Status Register = SPR[1]
ESR	Exception Status Register = SPR[5]
EAR	Exception Address Register = SPR[3]
FSR	Floating Point Unit Status Register = SPR[7]
PVR $x$	Processor Version Register, where $x$ is the register number = SPR[8192 + $x$ ]
BTR	Branch Target Register = SPR[11]
PC	Execute stage Program Counter = SPR[0]
$x[y]$	Bit $y$ of register $x$
$x[y:z]$	Bit range $y$ to $z$ of register $x$
$\bar{x}$	Bit inverted value of register $x$
Imm	16 bit immediate value
Imm $x$	$x$ bit immediate value
FSL $x$	4 bit Fast Simplex Link (FSL) or AXI4-Stream port designator, where $x$ is the port number
C	Carry flag, MSR[29]
Sa	Special Purpose Register, source operand
Sd	Special Purpose Register, destination operand
s( $x$ )	Sign extend argument $x$ to 32-bit value
*Addr	Memory contents at location Addr (data-size aligned)
:=	Assignment operator

**Table 2-5: Instruction Set Nomenclature (Continued)**

Symbol	Description
=	Equality comparison
!=	Inequality comparison
>	Greater than comparison
>=	Greater than or equal comparison
<	Less than comparison
<=	Less than or equal comparison
+	Arithmetic add
*	Arithmetic multiply
/	Arithmetic divide
>> <i>x</i>	Bit shift right <i>x</i> bits
<< <i>x</i>	Bit shift left <i>x</i> bits
and	Logic AND
or	Logic OR
xor	Logic exclusive OR
op1 if cond else op2	Perform <i>op1</i> if condition <i>cond</i> is true, else perform <i>op2</i>
&	Concatenate. E.g. “0000100 & Imm7” is the concatenation of the fixed field “0000100” and a 7 bit immediate value.
signed	Operation performed on signed integer data type. All arithmetic operations are performed on signed word operands, unless otherwise specified
unsigned	Operation performed on unsigned integer data type
float	Operation performed on floating point data type
clz( <i>r</i> )	Count leading zeros

**Table 2-6: MicroBlaze Instruction Set Summary**

Type A	0-5	6-10	11-15	16-20	21-31	Semantics
Type B	0-5	6-10	11-15	16-31		
ADD Rd,Ra,Rb	000000	Rd	Ra	Rb	0000000000	$Rd := Rb + Ra$
RSUB Rd,Ra,Rb	000001	Rd	Ra	Rb	0000000000	$Rd := Rb + \overline{Ra} + 1$
ADDC Rd,Ra,Rb	000010	Rd	Ra	Rb	0000000000	$Rd := Rb + Ra + C$
RSUBC Rd,Ra,Rb	000011	Rd	Ra	Rb	0000000000	$Rd := Rb + \overline{Ra} + C$
ADDK Rd,Ra,Rb	000100	Rd	Ra	Rb	0000000000	$Rd := Rb + Ra$
RSUBK Rd,Ra,Rb	000101	Rd	Ra	Rb	0000000000	$Rd := Rb + \overline{Ra} + 1$
ADDKC Rd,Ra,Rb	000110	Rd	Ra	Rb	0000000000	$Rd := Rb + Ra + C$

Table 2-6: MicroBlaze Instruction Set Summary (Continued)

Type A	0-5	6-10	11-15	16-20	21-31	Semantics
Type B	0-5	6-10	11-15	16-31		
RSUBKC Rd,Ra,Rb	000111	Rd	Ra	Rb	00000000000	$Rd := Rb + \overline{Ra} + C$
CMP Rd,Ra,Rb	000101	Rd	Ra	Rb	00000000001	$Rd := Rb + \overline{Ra} + 1$ Rd[0] := 0 if (Rb >= Ra) else Rd[0] := 1
CMPU Rd,Ra,Rb	000101	Rd	Ra	Rb	00000000011	$Rd := Rb + \overline{Ra} + 1$ (unsigned) Rd[0] := 0 if (Rb >= Ra, unsigned) else Rd[0] := 1
ADDI Rd,Ra,Imm	001000	Rd	Ra	Imm		$Rd := s(Imm) + Ra$
RSUBI Rd,Ra,Imm	001001	Rd	Ra	Imm		$Rd := s(Imm) + \overline{Ra} + 1$
ADDIC Rd,Ra,Imm	001010	Rd	Ra	Imm		$Rd := s(Imm) + Ra + C$
RSUBIC Rd,Ra,Imm	001011	Rd	Ra	Imm		$Rd := s(Imm) + \overline{Ra} + C$
ADDIK Rd,Ra,Imm	001100	Rd	Ra	Imm		$Rd := s(Imm) + Ra$
RSUBIK Rd,Ra,Imm	001101	Rd	Ra	Imm		$Rd := s(Imm) + \overline{Ra} + 1$
ADDIKC Rd,Ra,Imm	001110	Rd	Ra	Imm		$Rd := s(Imm) + Ra + C$
RSUBIKC Rd,Ra,Imm	001111	Rd	Ra	Imm		$Rd := s(Imm) + \overline{Ra} + C$
MUL Rd,Ra,Rb	010000	Rd	Ra	Rb	00000000000	$Rd := Ra * Rb$
MULH Rd,Ra,Rb	010000	Rd	Ra	Rb	00000000001	$Rd := (Ra * Rb) \gg 32$ (signed)
MULHU Rd,Ra,Rb	010000	Rd	Ra	Rb	00000000011	$Rd := (Ra * Rb) \gg 32$ (unsigned)
MULHSU Rd,Ra,Rb	010000	Rd	Ra	Rb	00000000010	$Rd := (Ra, \text{signed} * Rb, \text{unsigned}) \gg 32$ (signed)
BSRA Rd,Ra,Rb	010001	Rd	Ra	Rb	01000000000	$Rd := s(Ra \gg Rb)$
BSLL Rd,Ra,Rb	010001	Rd	Ra	Rb	10000000000	$Rd := (Ra \ll Rb) \& 0$
MULI Rd,Ra,Imm	011000	Rd	Ra	Imm		$Rd := Ra * s(Imm)$
BSRLI Rd,Ra,Imm	011001	Rd	Ra	00000000000 & Imm5		$Rd := 0 \& (Ra \gg Imm5)$
BSRAI Rd,Ra,Imm	011001	Rd	Ra	00000100000 & Imm5		$Rd := s(Ra \gg Imm5)$
BSLLI Rd,Ra,Imm	011001	Rd	Ra	00000100000 & Imm5		$Rd := (Ra \ll Imm5) \& 0$
IDIV Rd,Ra,Rb	010010	Rd	Ra	Rb	00000000000	$Rd := Rb/Ra$
IDIVU Rd,Ra,Rb	010010	Rd	Ra	Rb	00000000010	$Rd := Rb/Ra$ , unsigned
TNEAGETD Rd,Rb	010011	Rd	00000	Rb	0NOTAE 00000	$Rd := \text{FSL } Rb[28:31]$ (data read) MSR[FSL] := 1 if (FSL_S_Control = 1) MSR[C] := not FSL_S_Exists if N = 1



Table 2-6: MicroBlaze Instruction Set Summary (Continued)

Type A	0-5	6-10	11-15	16-20	21-31	Semantics
Type B	0-5	6-10	11-15	16-31		
<i>TNAPUTD</i> Ra,Rb	010011	00000	Ra	Rb	0N0T40 00000	FSL Rb[28:31] := Ra (data write) MSR[C] := FSL_M_Full if N = 1
<i>TNECAGETD</i> Rd,Rb	010011	Rd	00000	Rb	0N1TAE 00000	Rd := FSL Rb[28:31] (control read) MSR[FSL] := 1 if (FSL_S_Control = 0) MSR[C] := not FSL_S_Exists if N = 1
<i>TNCAPUTD</i> Ra,Rb	010011	00000	Ra	Rb	0N1T40 00000	FSL Rb[28:31] := Ra (control write) MSR[C] := FSL_M_Full if N = 1
FADD Rd,Ra,Rb	010110	Rd	Ra	Rb	00000000000	Rd := Rb+Ra, float <sup>1</sup>
FRSUB Rd,Ra,Rb	010110	Rd	Ra	Rb	00010000000	Rd := Rb-Ra, float <sup>1</sup>
FMUL Rd,Ra,Rb	010110	Rd	Ra	Rb	00100000000	Rd := Rb*Ra, float <sup>1</sup>
FDIV Rd,Ra,Rb	010110	Rd	Ra	Rb	00110000000	Rd := Rb/Ra, float <sup>1</sup>
FCMP.UN Rd,Ra,Rb	010110	Rd	Ra	Rb	01000000000	Rd := 1 if (Rb = NaN or Ra = NaN, float <sup>1</sup> ) else Rd := 0
FCMP.LT Rd,Ra,Rb	010110	Rd	Ra	Rb	01000010000	Rd := 1 if (Rb < Ra, float <sup>1</sup> ) else Rd := 0
FCMP.EQ Rd,Ra,Rb	010110	Rd	Ra	Rb	01000100000	Rd := 1 if (Rb = Ra, float <sup>1</sup> ) else Rd := 0
FCMP.LE Rd,Ra,Rb	010110	Rd	Ra	Rb	01000110000	Rd := 1 if (Rb <= Ra, float <sup>1</sup> ) else Rd := 0
FCMP.GT Rd,Ra,Rb	010110	Rd	Ra	Rb	01001000000	Rd := 1 if (Rb > Ra, float <sup>1</sup> ) else Rd := 0
FCMP.NE Rd,Ra,Rb	010110	Rd	Ra	Rb	01001010000	Rd := 1 if (Rb != Ra, float <sup>1</sup> ) else Rd := 0
FCMP.GE Rd,Ra,Rb	010110	Rd	Ra	Rb	01001100000	Rd := 1 if (Rb >= Ra, float <sup>1</sup> ) else Rd := 0
FLT Rd,Ra	010110	Rd	Ra	0	01010000000	Rd := float (Ra) <sup>1</sup>
FINT Rd,Ra	010110	Rd	Ra	0	01100000000	Rd := int (Ra) <sup>1</sup>
FSQRT Rd,Ra	010110	Rd	Ra	0	01110000000	Rd := sqrt (Ra) <sup>1</sup>
<i>TNEAGET</i> Rd,FSLx	011011	Rd	00000	0N0TAE000000 & FSLx		Rd := FSLx (data read, blocking if N = 0) MSR[FSL] := 1 if (FSLx_S_Control = 1) MSR[C] := not FSLx_S_Exists if N = 1
<i>TNAPUT</i> Ra,FSLx	011011	00000	Ra	1N0T40000000 & FSLx		FSLx := Ra (data write, blocking if N = 0) MSR[C] := FSLx_M_Full if N = 1
<i>TNECAGET</i> Rd,FSLx	011011	Rd	00000	0N1TAE000000 & FSLx		Rd := FSLx (control read, blocking if N = 0) MSR[FSL] := 1 if (FSLx_S_Control = 0) MSR[C] := not FSLx_S_Exists if N = 1

Table 2-6: MicroBlaze Instruction Set Summary (Continued)

Type A	0-5	6-10	11-15	16-20	21-31	Semantics
Type B	0-5	6-10	11-15	16-31		
TNCAPUT Ra,FSLx	011011	00000	Ra	1N17A0000000 & FSLx		FSLx := Ra (control write, blocking if N = 0) MSR[C] := FSLx_M_Full if N = 1
OR Rd,Ra,Rb	100000	Rd	Ra	Rb	00000000000	Rd := Ra or Rb
AND Rd,Ra,Rb	100001	Rd	Ra	Rb	00000000000	Rd := Ra and Rb
XOR Rd,Ra,Rb	100010	Rd	Ra	Rb	00000000000	Rd := Ra xor Rb
ANDN Rd,Ra,Rb	100011	Rd	Ra	Rb	00000000000	Rd := Ra and $\overline{Rb}$
PCMPBF Rd,Ra,Rb	100000	Rd	Ra	Rb	10000000000	Rd := 1 if (Rb[0:7] = Ra[0:7]) else Rd := 2 if (Rb[8:15] = Ra[8:15]) else Rd := 3 if (Rb[16:23] = Ra[16:23]) else Rd := 4 if (Rb[24:31] = Ra[24:31]) else Rd := 0
PCMPEQ Rd,Ra,Rb	100010	Rd	Ra	Rb	10000000000	Rd := 1 if (Rd = Ra) else Rd := 0
PCMPNE Rd,Ra,Rb	100011	Rd	Ra	Rb	10000000000	Rd := 1 if (Rd != Ra) else Rd := 0
SRA Rd,Ra	100100	Rd	Ra	0000000000000001		Rd := s(Ra >> 1) C := Ra[31]
SRC Rd,Ra	100100	Rd	Ra	000000000100001		Rd := C & (Ra >> 1) C := Ra[31]
SRL Rd,Ra	100100	Rd	Ra	000000001000001		Rd := 0 & (Ra >> 1) C := Ra[31]
SEXT8 Rd,Ra	100100	Rd	Ra	000000001100000		Rd := s(Ra[24:31])
SEXT16 Rd,Ra	100100	Rd	Ra	000000001100001		Rd := s(Ra[16:31])
CLZ Rd, Ra	100100	Rd	Ra	000000011100000		Rd = clz(Ra)
SWAPB Rd, Ra	100100	Rd	Ra	0000000111100000		Rd = (Ra)[24:31, 16:23, 8:15, 0:7]
SWAPH Rd, Ra	100100	Rd	Ra	0000000111100010		Rd = (Ra)[16:31, 0:15]
WIC Ra,Rb	100100	00000	Ra	Rb	00001101000	ICache_Line[Ra >> 4].Tag := 0 if (C_ICACHE_LINE_LEN = 4) ICache_Line[Ra >> 5].Tag := 0 if (C_ICACHE_LINE_LEN = 8)
WDC Ra,Rb	100100	00000	Ra	Rb	00001100100	Cache line is cleared, discarding stored data. DCache_Line[Ra >> 4].Tag := 0 if (C_DCACHE_LINE_LEN = 4) DCache_Line[Ra >> 5].Tag := 0 if (C_DCACHE_LINE_LEN = 8)

Table 2-6: MicroBlaze Instruction Set Summary (Continued)

Type A	0-5	6-10	11-15	16-20	21-31	Semantics
Type B	0-5	6-10	11-15	16-31		
WDC.FLUSH Ra,Rb	100100	00000	Ra	Rb	00001110100	Cache line is flushed, writing stored data to memory, and then cleared. Used when C_DCACHE_USE_WRITEBACK = 1.
WDC.CLEAR Ra,Rb	100100	00000	Ra	Rb	00001110110	Cache line with matching address is cleared, discarding stored data. Used when C_DCACHE_USE_WRITEBACK = 1.
MBAR Imm	101110	Imm	00010	000000000000100		PC := PC + 4; Wait for memory accesses.
MTS Sd,Ra	100101	00000	Ra	11 & Sd		SPR[Sd] := Ra, where: <ul style="list-style-type: none"> <li>• SPR[0x0001] is MSR</li> <li>• SPR[0x0007] is FSR</li> <li>• SPR[0x0800] is SLR</li> <li>• SPR[0x0802] is SHR</li> <li>• SPR[0x1000] is PID</li> <li>• SPR[0x1001] is ZPR</li> <li>• SPR[0x1002] is TLBX</li> <li>• SPR[0x1003] is TLBLO</li> <li>• SPR[0x1004] is TLBHI</li> <li>• SPR[0x1005] is TLBSX</li> </ul>
MFS Rd,Sa	100101	Rd	00000	10 & Sa		Rd := SPR[Sa], where: <ul style="list-style-type: none"> <li>• SPR[0x0000] is PC</li> <li>• SPR[0x0001] is MSR</li> <li>• SPR[0x0003] is EAR</li> <li>• SPR[0x0005] is ESR</li> <li>• SPR[0x0007] is FSR</li> <li>• SPR[0x000B] is BTR</li> <li>• SPR[0x000D] is EDR</li> <li>• SPR[0x0800] is SLR</li> <li>• SPR[0x0802] is SHR</li> <li>• SPR[0x1000] is PID</li> <li>• SPR[0x1001] is ZPR</li> <li>• SPR[0x1002] is TLBX</li> <li>• SPR[0x1003] is TLBLO</li> <li>• SPR[0x1004] is TLBHI</li> <li>• SPR[0x2000 to 0x200B] is PVR[0 to 12]</li> </ul>
MSRCLR Rd,Imm	100101	Rd	00001	00 & Imm14		Rd := MSR MSR := MSR and $\overline{\text{Imm14}}$
MSRSET Rd,Imm	100101	Rd	00000	00 & Imm14		Rd := MSR MSR := MSR or Imm14
BR Rb	100110	00000	00000	Rb	00000000000	PC := PC + Rb
BRD Rb	100110	00000	10000	Rb	00000000000	PC := PC + Rb

Table 2-6: MicroBlaze Instruction Set Summary (Continued)

Type A	0-5	6-10	11-15	16-20	21-31	Semantics
Type B	0-5	6-10	11-15	16-31		
BRLD Rd,Rb	100110	Rd	10100	Rb	00000000000	PC := PC + Rb Rd := PC
BRA Rb	100110	00000	01000	Rb	00000000000	PC := Rb
BRAD Rb	100110	00000	11000	Rb	00000000000	PC := Rb
BRALD Rd,Rb	100110	Rd	11100	Rb	00000000000	PC := Rb Rd := PC
BRK Rd,Rb	100110	Rd	01100	Rb	00000000000	PC := Rb Rd := PC MSR[BIP] := 1
BEQ Ra,Rb	100111	00000	Ra	Rb	00000000000	PC := PC + Rb if Ra = 0
BNE Ra,Rb	100111	00001	Ra	Rb	00000000000	PC := PC + Rb if Ra != 0
BLT Ra,Rb	100111	00010	Ra	Rb	00000000000	PC := PC + Rb if Ra < 0
BLE Ra,Rb	100111	00011	Ra	Rb	00000000000	PC := PC + Rb if Ra <= 0
BGT Ra,Rb	100111	00100	Ra	Rb	00000000000	PC := PC + Rb if Ra > 0
BGE Ra,Rb	100111	00101	Ra	Rb	00000000000	PC := PC + Rb if Ra >= 0
BEQD Ra,Rb	100111	10000	Ra	Rb	00000000000	PC := PC + Rb if Ra = 0
BNED Ra,Rb	100111	10001	Ra	Rb	00000000000	PC := PC + Rb if Ra != 0
BLTD Ra,Rb	100111	10010	Ra	Rb	00000000000	PC := PC + Rb if Ra < 0
BLED Ra,Rb	100111	10011	Ra	Rb	00000000000	PC := PC + Rb if Ra <= 0
BGTD Ra,Rb	100111	10100	Ra	Rb	00000000000	PC := PC + Rb if Ra > 0
BGED Ra,Rb	100111	10101	Ra	Rb	00000000000	PC := PC + Rb if Ra >= 0
ORI Rd,Ra,Imm	101000	Rd	Ra	Imm		Rd := Ra or s(Imm)
ANDI Rd,Ra,Imm	101001	Rd	Ra	Imm		Rd := Ra and s(Imm)
XORI Rd,Ra,Imm	101010	Rd	Ra	Imm		Rd := Ra xor s(Imm)
ANDNI Rd,Ra,Imm	101011	Rd	Ra	Imm		Rd := Ra and $\overline{s(Imm)}$
IMM Imm	101100	00000	00000	Imm		Imm[0:15] := Imm
RTSD Ra,Imm	101101	10000	Ra	Imm		PC := Ra + s(Imm)
RTID Ra,Imm	101101	10001	Ra	Imm		PC := Ra + s(Imm) MSR[IE] := 1
RTBD Ra,Imm	101101	10010	Ra	Imm		PC := Ra + s(Imm) MSR[BIP] := 0
RTED Ra,Imm	101101	10100	Ra	Imm		PC := Ra + s(Imm) MSR[EE] := 1, MSR[EIP] := 0 ESR := 0

Table 2-6: MicroBlaze Instruction Set Summary (Continued)

Type A	0-5	6-10	11-15	16-20	21-31	Semantics
Type B	0-5	6-10	11-15	16-31		
BRI Imm	101110	00000	00000	Imm		PC := PC + s(Imm)
BRID Imm	101110	00000	10000	Imm		PC := PC + s(Imm)
BRLID Rd,Imm	101110	Rd	10100	Imm		PC := PC + s(Imm) Rd := PC
BRAI Imm	101110	00000	01000	Imm		PC := s(Imm)
BRAID Imm	101110	00000	11000	Imm		PC := s(Imm)
BRALID Rd,Imm	101110	Rd	11100	Imm		PC := s(Imm) Rd := PC
BRKI Rd,Imm	101110	Rd	01100	Imm		PC := s(Imm) Rd := PC MSR[BIP] := 1
BEQI Ra,Imm	101111	00000	Ra	Imm		PC := PC + s(Imm) if Ra = 0
BNEI Ra,Imm	101111	00001	Ra	Imm		PC := PC + s(Imm) if Ra != 0
BLTI Ra,Imm	101111	00010	Ra	Imm		PC := PC + s(Imm) if Ra < 0
BLEI Ra,Imm	101111	00011	Ra	Imm		PC := PC + s(Imm) if Ra <= 0
BGTI Ra,Imm	101111	00100	Ra	Imm		PC := PC + s(Imm) if Ra > 0
BGEI Ra,Imm	101111	00101	Ra	Imm		PC := PC + s(Imm) if Ra >= 0
BEQID Ra,Imm	101111	10000	Ra	Imm		PC := PC + s(Imm) if Ra = 0
BNEID Ra,Imm	101111	10001	Ra	Imm		PC := PC + s(Imm) if Ra != 0
BLTID Ra,Imm	101111	10010	Ra	Imm		PC := PC + s(Imm) if Ra < 0
BLEID Ra,Imm	101111	10011	Ra	Imm		PC := PC + s(Imm) if Ra <= 0
BGTID Ra,Imm	101111	10100	Ra	Imm		PC := PC + s(Imm) if Ra > 0
BGEID Ra,Imm	101111	10101	Ra	Imm		PC := PC + s(Imm) if Ra >= 0
LBU Rd,Ra,Rb LBUR Rd,Ra,Rb	110000	Rd	Ra	Rb	0000000000 0100000000	Addr := Ra + Rb Rd[0:23] := 0 Rd[24:31] := *Addr[0:7]
LHU Rd,Ra,Rb LHUR Rd,Ra,Rb	110001	Rd	Ra	Rb	0000000000 0100000000	Addr := Ra + Rb Rd[0:15] := 0 Rd[16:31] := *Addr[0:15]
LW Rd,Ra,Rb LWR Rd,Ra,Rb	110010	Rd	Ra	Rb	0000000000 0100000000	Addr := Ra + Rb Rd := *Addr
LWX Rd,Ra,Rb	110010	Rd	Ra	Rb	1000000000	Addr := Ra + Rb Rd := *Addr Reservation := 1

Table 2-6: MicroBlaze Instruction Set Summary (Continued)

Type A	0-5	6-10	11-15	16-20	21-31	Semantics
Type B	0-5	6-10	11-15	16-31		
SB Rd,Ra,Rb SBR Rd,Ra,Rb	110100	Rd	Ra	Rb	0000000000 0100000000	Addr := Ra + Rb *Addr[0:8] := Rd[24:31]
SH Rd,Ra,Rb SHR Rd,Ra,Rb	110101	Rd	Ra	Rb	0000000000 0100000000	Addr := Ra + Rb *Addr[0:16] := Rd[16:31]
SW Rd,Ra,Rb SWR Rd,Ra,Rb	110110	Rd	Ra	Rb	0000000000 0100000000	Addr := Ra + Rb *Addr := Rd
SWX Rd,Ra,Rb	110110	Rd	Ra	Rb	1000000000	Addr := Ra + Rb *Addr := Rd if Reservation = 1 Reservation := 0
LBUI Rd,Ra,Imm	111000	Rd	Ra	Imm		Addr := Ra + s(Imm) Rd[0:23] := 0 Rd[24:31] := *Addr[0:7]
LHUI Rd,Ra,Imm	111001	Rd	Ra	Imm		Addr := Ra + s(Imm) Rd[0:15] := 0 Rd[16:31] := *Addr[0:15]
LWI Rd,Ra,Imm	111010	Rd	Ra	Imm		Addr := Ra + s(Imm) Rd := *Addr
SBI Rd,Ra,Imm	111100	Rd	Ra	Imm		Addr := Ra + s(Imm) *Addr[0:7] := Rd[24:31]
SHI Rd,Ra,Imm	111101	Rd	Ra	Imm		Addr := Ra + s(Imm) *Addr[0:15] := Rd[16:31]
SWI Rd,Ra,Imm	111110	Rd	Ra	Imm		Addr := Ra + s(Imm) *Addr := Rd

1. Due to the many different corner cases involved in floating point arithmetic, only the normal behavior is described. A full description of the behavior can be found in [Chapter 5, “MicroBlaze Instruction Set Architecture.”](#)

## Semaphore Synchronization

The LWX and SWX instructions are used to implement common semaphore operations, including test and set, compare and swap, exchange memory, and fetch and add. They are also used to implement spinlocks.

These instructions are typically used by system programs and are called by application programs as needed. Generally, a program uses LWX to load a semaphore from memory, causing the reservation to be set (the processor maintains the reservation internally). The program can compute a result based on the semaphore value and conditionally store the result back to the same memory location using the SWX instruction. The conditional store is performed based on the existence of the reservation established by the preceding LWX instruction. If the reservation exists when the store is executed, the store is performed and MSR[C] is cleared to 0. If the reservation does not exist when the store is executed, the target memory location is not modified and MSR[C] is set to 1.

If the store is successful, the sequence of instructions from the semaphore load to the semaphore store appear to be executed atomically—no other device modified the semaphore location between

the read and the update. Other devices can read from the semaphore location during the operation. For a semaphore operation to work properly, the LWX instruction must be paired with an SWX instruction, and both must specify identical addresses. The reservation granularity in MicroBlaze is a word. For both instructions, the address must be word aligned. No unaligned exceptions are generated for these instructions.

The conditional store is always performed when a reservation exists, even if the store address does not match the load address that set the reservation.

Only one reservation can be maintained at a time. The address associated with the reservation can be changed by executing a subsequent LWX instruction. The conditional store is performed based upon the reservation established by the last LWX instruction executed. Executing an SWX instruction always clears a reservation held by the processor, whether the address matches that established by the LWX or not.

Reset, interrupts, exceptions, and breaks (including the BRK and BRKI instructions) all clear the reservation.

The following provides general guidelines for using the LWX and SWX instructions:

- The LWX and SWX instructions should be paired and use the same address.
- An unpaired SWX instruction to an arbitrary address can be used to clear any reservation held by the processor.
- A conditional sequence begins with an LWX instruction. It can be followed by memory accesses and/or computations on the loaded value. The sequence ends with an SWX instruction. In most cases, failure of the SWX instruction should cause a branch back to the LWX for a repeated attempt.
- An LWX instruction can be left unpaired when executing certain synchronization primitives if the value loaded by the LWX is not zero. An implementation of Test and Set exemplifies this:

```
loop: lw      r5,r3,r0 ; load and reserve
      bnei   r5,next  ; branch if not equal to zero
      addik  r5,r5,1  ; increment value
      swx   r5,r3,r0  ; try to store non-zero value
      addic  r5,r0,0  ; check reservation
      bnei   r5,loop  ; loop if reservation lost
next:
```

- Performance can be improved by minimizing looping on an LWX instruction that fails to return a desired value. Performance can also be improved by using an ordinary load instruction to do the initial value check. An implementation of a spinlock exemplifies this:

```
loop: lw      r5,r3,r0 ; load the word
      bnei   r5,loop  ; loop back if word not equal to 0
      lw     r5,r3,r0 ; try reserving again
      bnei   r5,loop  ; likely that no branch is needed
      addik  r5,r5,1  ; increment value
      swx   r5,r3,r0  ; try to store non-zero value
      addic  r5,r0,0  ; check reservation
      bnei   r5,loop  ; loop if reservation lost
```

- Minimizing the looping on an LWX/SWX instruction pair increases the likelihood that forward progress is made. The old value should be tested before attempting the store. If the order is reversed (store before load), more SWX instructions are executed and reservations are more likely to be lost between the LWX and SWX instructions.

## Self-modifying Code

When using self-modifying code software must ensure that the modified instructions have been written to memory prior to fetching them for execution. There are several aspects to consider:

- The instructions to be modified may already have been fetched prior to modification:
  - ◆ into the instruction prefetch buffer,
  - ◆ into the instruction cache, if it is enabled,
  - ◆ into a stream buffer, if instruction cache stream buffers are used,
  - ◆ into the instruction cache, and then saved in a victim buffer, if victim buffers are used.

To ensure that the modified code is always executed instead of the old unmodified code, software must handle all these cases.

- If one or more of the instructions to be modified is a branch, and the branch target cache is used, the branch target address may have been cached.

To avoid using the cached branch target address, software must ensure that the branch target cache is cleared prior to executing the modified code.

- The modified instructions may not have been written to memory prior to execution:
  - ◆ they may be en route to memory, in temporary storage in the interconnect or the memory controller,
  - ◆ they may be stored in the data cache, if write-back cache is used,
  - ◆ they may be saved in a victim buffer, if write-back cache and victim buffers are used.

Software must ensure that the modified instructions have been written to memory before being fetched by the processor.

The annotated code below shows how each of the above issues can be addressed. This code assumes that both instruction cache and write-back data cache is used. If not, the corresponding instructions can be omitted.

The following code exemplifies storing a modified instruction, when using AXI interconnect:

```
swi      r5,r6,0 ; r5 = new instruction
                               ; r6 = physical instruction address
wdc.flush r6,r0 ; flush write-back data cache line
mbar     1       ; ensure new instruction is written to memory
wic      r7,r0   ; invalidate line, empty stream & victim buffers
                               ; r7 = virtual instruction address
mbar     2       ; empty prefetch buffer, clear branch target cache
```

The following code exemplifies storing a modified instruction, when using XCL:

```
swi      r5,r6,0 ; r5 = new instruction
                               ; r6 = physical instruction address
wdc.flush r6,r0 ; flush write-back data cache line
lwi      r0,r6,0 ; read back new instruction from memory to ensure it
                               ; has been written to memory
wic      r7,r0   ; invalidate line, empty stream & victim buffers
                               ; r7 = virtual instruction address
mbar     2       ; empty prefetch buffer, clear branch target cache
```

The physical and virtual addresses above are identical, unless MMU virtual mode is used. If the MMU is enabled, the code sequences must be executed in real mode, since WIC and WDC are privileged instructions.

The first instruction after the code sequences above must not be modified, since it may have been prefetched.



# Registers

MicroBlaze has an orthogonal instruction set architecture. It has thirty-two 32-bit general purpose registers and up to eighteen 32-bit special purpose registers, depending on configured options.

## General Purpose Registers

The thirty-two 32-bit General Purpose Registers are numbered R0 through R31. The register file is reset on bit stream download (reset value is 0x00000000). [Figure 2-2](#) is a representation of a General Purpose Register and [Table 2-7](#) provides a description of each register and the register reset value (if existing).

**Note:** The register file is **not** reset by the external reset inputs: `Reset`, `MB_Reset` and `Debug_Rst`.

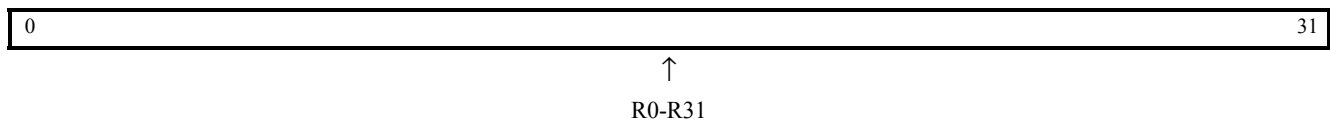

Figure 2-2: R0-R31

Table 2-7: General Purpose Registers (R0-R31)

Bits	Name	Description	Reset Value
0:31	R0	Always has a value of zero. Anything written to R0 is discarded	0x00000000
0:31	R1 through R13	32-bit general purpose registers	-
0:31	R14	32-bit register used to store return addresses for interrupts.	-
0:31	R15	32-bit general purpose register. Recommended for storing return addresses for user vectors.	-
0:31	R16	32-bit register used to store return addresses for breaks.	-
0:31	R17	If MicroBlaze is configured to support hardware exceptions, this register is loaded with the address of the instruction following the instruction causing the HW exception, except for exceptions in delay slots that use BTR instead (see “ <a href="#">Branch Target Register (BTR)</a> ”); if not, it is a general purpose register.	-
0:31	R18 through R31	R18 through R31 are 32-bit general purpose registers.	-

Refer to [Table 4-2](#) for software conventions on general purpose register usage.

## Special Purpose Registers

### Program Counter (PC)

The Program Counter (PC) is the 32-bit address of the execution instruction. It can be read with an MFS instruction, but it cannot be written with an MTS instruction. When used with the MFS instruction the PC register is specified by setting Sa = 0x0000. [Figure 2-3](#) illustrates the PC and [Table 2-8](#) provides a description and reset value.

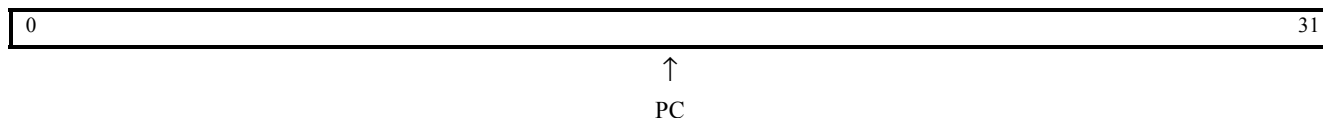

Figure 2-3: PC

Table 2-8: Program Counter (PC)

Bits	Name	Description	Reset Value
0:31	PC	Program Counter Address of executing instruction, that is, “mfs r2 0” stores the address of the mfs instruction itself in R2.	0x00000000

### Machine Status Register (MSR)

The Machine Status Register contains control and status bits for the processor. It can be read with an MFS instruction. When reading the MSR, bit 29 is replicated in bit 0 as the carry copy. MSR can be written using either an MTS instruction or the dedicated MSRSET and MSRCLR instructions.

When writing to the MSR using MSRSET or MSRCLR, the Carry bit takes effect immediately and the remaining bits take effect one clock cycle later. When writing using MTS, all bits take effect one clock cycle later. Any value written to bit 0 is discarded.

When used with an MTS or MFS instruction, the MSR is specified by setting Sx = 0x0001.

[Figure 2-4](#) illustrates the MSR register and [Table 2-9](#) provides the bit description and reset values.

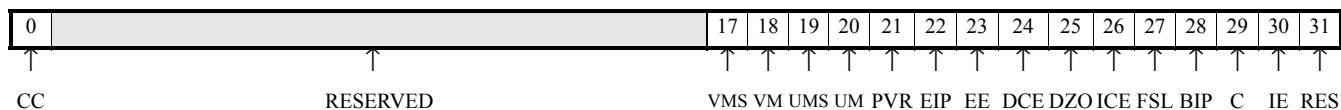

Figure 2-4: MSR

Table 2-9: Machine Status Register (MSR)

Bits	Name	Description	Reset Value
0	CC	Arithmetic Carry Copy Copy of the Arithmetic Carry (bit 29). CC is always the same as bit C.	0
1:16	Reserved		
17	VMS	Virtual Protected Mode Save Only available when configured with an MMU (if C_USE_MMU > 1 and C_AREA_OPTIMIZED = 0) Read/Write	0
18	VM	Virtual Protected Mode 0 = MMU address translation and access protection disabled, with C_USE_MMU = 3 (Virtual). Access protection disabled with C_USE_MMU = 2 (Protection) 1 = MMU address translation and access protection enabled, with C_USE_MMU = 3 (Virtual). Access protection enabled, with C_USE_MMU = 2 (Protection). Only available when configured with an MMU (if C_USE_MMU > 1 and C_AREA_OPTIMIZED = 0) Read/Write	0
19	UMS	User Mode Save Only available when configured with an MMU (if C_USE_MMU > 0 and C_AREA_OPTIMIZED = 0) Read/Write	0
20	UM	User Mode 0 = Privileged Mode, all instructions are allowed 1 = User Mode, certain instructions are not allowed Only available when configured with an MMU (if C_USE_MMU > 0 and C_AREA_OPTIMIZED = 0) Read/Write	0
21	PVR	Processor Version Register exists 0 = No Processor Version Register 1 = Processor Version Register exists Read only	Based on parameter C_PVR
22	EIP	Exception In Progress 0 = No hardware exception in progress 1 = Hardware exception in progress Only available if configured with exception support (C*_EXCEPTION or C_USE_MMU > 0) Read/Write	0

Table 2-9: Machine Status Register (MSR) (Continued)

Bits	Name	Description	Reset Value
23	EE	Exception Enable 0 = Hardware exceptions disabled <sup>1</sup> 1 = Hardware exceptions enabled  Only available if configured with exception support (C_*_EXCEPTION or C_USE_MMU > 0)  Read/Write	0
24	DCE	Data Cache Enable 0 = Data Cache disabled 1 = Data Cache enabled  Only available if configured to use data cache (C_USE_DCACHE = 1)  Read/Write	0
25	DZO	Division by Zero or Division Overflow <sup>2</sup> 0 = No division by zero or division overflow has occurred 1 = Division by zero or division overflow has occurred  Only available if configured to use hardware divider (C_USE_DIV = 1)  Read/Write	0
26	ICE	Instruction Cache Enable 0 = Instruction Cache disabled 1 = Instruction Cache enabled  Only available if configured to use instruction cache (C_USE_ICACHE = 1)  Read/Write	0
27	FSL	Stream (FSL or AXI) Error 0 = get or getd had no error 1 = get or getd control type mismatch  This bit is sticky, i.e. it is set by a get or getd instruction when a control bit mismatch occurs. To clear it an mts or msrclr instruction must be used.  Only available if configured to use stream links (C_FSL_LINKS > 0)  Read/Write	0
28	BIP	Break in Progress 0 = No Break in Progress 1 = Break in Progress  Break Sources can be software break instruction or hardware break from Ext_Brk or Ext_NM_Brk pin.  Read/Write	0

Table 2-9: Machine Status Register (MSR) (Continued)

Bits	Name	Description	Reset Value
29	C	Arithmetic Carry 0 = No Carry (Borrow) 1 = Carry (No Borrow) Read/Write	0
30	IE	Interrupt Enable 0 = Interrupts disabled 1 = Interrupts enabled Read/Write	0
31	-	Reserved	0

1. The MMU exceptions (Data Storage Exception, Instruction Storage Exception, Data TLB Miss Exception, Instruction TLB Miss Exception) cannot be disabled, and are not affected by this bit.
2. This bit is only used for integer divide-by-zero or divide overflow signaling. There is a floating point equivalent in the FSR. The DZO-bit flags divide by zero or divide overflow conditions regardless if the processor is configured with exception handling or not.

## Exception Address Register (EAR)

The Exception Address Register stores the full load/store address that caused the exception for the following:

- An unaligned access exception that means the unaligned access address
- A DPLB or M\_AXI\_DP exception that specifies the failing PLB or AXI4 data access address
- A data storage exception that specifies the (virtual) effective address accessed
- An instruction storage exception that specifies the (virtual) effective address read
- A data TLB miss exception that specifies the (virtual) effective address accessed
- An instruction TLB miss exception that specifies the (virtual) effective address read

The contents of this register is undefined for all other exceptions. When read with the MFS instruction, the EAR is specified by setting Sa = 0x0003. The EAR register is illustrated in [Figure 2-5](#) and [Table 2-10](#) provides bit descriptions and reset values.

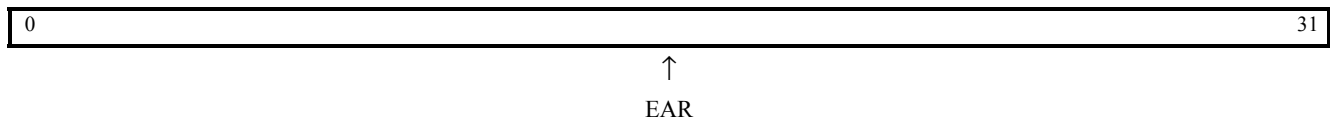

*Figure 2-5: EAR*

*Table 2-10: Exception Address Register (EAR)*

Bits	Name	Description	Reset Value
0:31	EAR	Exception Address Register	0x00000000

## Exception Status Register (ESR)

The Exception Status Register contains status bits for the processor. When read with the MFS instruction, the ESR is specified by setting Sa = 0x0005. The ESR register is illustrated in Figure 2-6, Table 2-11 provides bit descriptions and reset values, and Table 2-12 provides the Exception Specific Status (ESS).

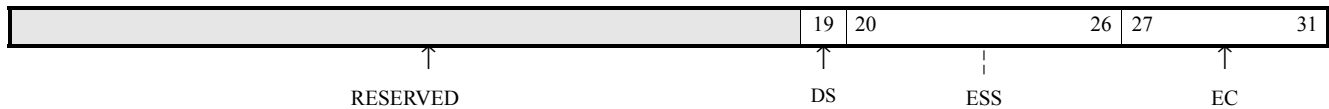

Figure 2-6: ESR

Table 2-11: Exception Status Register (ESR)

Bits	Name	Description	Reset Value
0:18	Reserved		
19	DS	Delay Slot Exception. 0 = not caused by delay slot instruction 1 = caused by delay slot instruction Read-only	0
20:26	ESS	Exception Specific Status For details refer to Table 2-12. Read-only	See Table 2-12
27:31	EC	Exception Cause 00000 = Stream exception 00001 = Unaligned data access exception 00010 = Illegal op-code exception 00011 = Instruction bus error exception 00100 = Data bus error exception 00101 = Divide exception 00110 = Floating point unit exception 00111 = Privileged instruction exception 00111 = Stack protection violation exception 10000 = Data storage exception 10001 = Instruction storage exception 10010 = Data TLB miss exception 10011 = Instruction TLB miss exception Read-only	0

Table 2-12: Exception Specific Status (ESS)

Exception Cause	Bits	Name	Description	Reset Value
Unaligned Data Access	20	W	Word Access Exception 0 = unaligned halfword access 1 = unaligned word access	0
	21	S	Store Access Exception 0 = unaligned load access 1 = unaligned store access	0
	22:26	Rx	Source/Destination Register General purpose register used as source (Store) or destination (Load) in unaligned access	0
Illegal Instruction	20:26	Reserved		0
Instruction bus error	20	ECC	Exception caused by ILMB correctable or uncorrectable error	0
	21:26	Reserved		0
Data bus error	20	ECC	Exception caused by DLMB correctable or uncorrectable error	0
	21:26	Reserved		0
Divide	20	DEC	Divide - Division exception cause 0 = Divide-By-Zero 1 = Division Overflow	0
	21:26	Reserved		0
Floating point unit	20:26	Reserved		0
Privileged instruction	20:26	Reserved		0
Stack protection violation	20:26	Reserved		0
Stream	20:22	Reserved		0
	23:26	FSL	Stream (FSL or AXI) index that caused the exception	0
Data storage	20	DIZ	Data storage - Zone protection 0 = Did not occur 1 = Occurred	0
	21	S	Data storage - Store instruction 0 = Did not occur 1 = Occurred	0
	22:26	Reserved		0



Table 2-12: Exception Specific Status (ESS) (Continued)

Exception Cause	Bits	Name	Description	Reset Value
Instruction storage	20	DIZ	Instruction storage - Zone protection 0 = Did not occur 1 = Occurred	0
	21:26	Reserved		0
Data TLB miss	20	Reserved		0
	21	S	Data TLB miss - Store instruction 0 = Did not occur 1 = Occurred	0
	22:26	Reserved		0
Instruction TLB miss	20:26	Reserved		0

### Branch Target Register (BTR)

The Branch Target Register only exists if the MicroBlaze processor is configured to use exceptions. The register stores the branch target address for all delay slot branch instructions executed while MSR[EIP] = 0. If an exception is caused by an instruction in a delay slot (that is, ESR[DS]=1), the exception handler should return execution to the address stored in BTR instead of the normal exception return address stored in R17. When read with the MFS instruction, the BTR is specified by setting Sa = 0x000B. The BTR register is illustrated in Figure 2-7 and Table 2-13 provides bit descriptions and reset values.

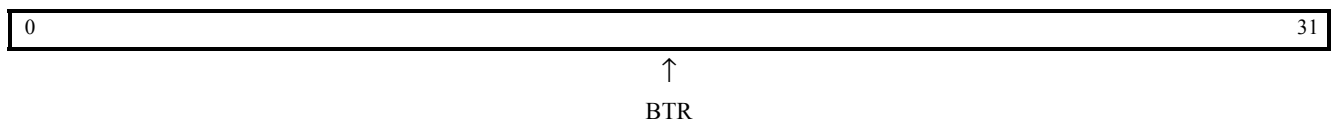

Figure 2-7: BTR

Table 2-13: Branch Target Register (BTR)

Bits	Name	Description	Reset Value
0:31	BTR	Branch target address used by handler when returning from an exception caused by an instruction in a delay slot.  Read-only	0x00000000

## Floating Point Status Register (FSR)

The Floating Point Status Register contains status bits for the floating point unit. It can be read with an MFS, and written with an MTS instruction. When read or written, the register is specified by setting  $Sa = 0x0007$ . The bits in this register are sticky – floating point instructions can only set bits in the register, and the only way to clear the register is by using the MTS instruction. [Figure 2-8](#) illustrates the FSR register and [Table 2-14](#) provides bit descriptions and reset values.



Figure 2-8: FSR

Table 2-14: Floating Point Status Register (FSR)

Bits	Name	Description	Reset Value
0:26	Reserved		undefined
27	IO	Invalid operation	0
28	DZ	Divide-by-zero	0
29	OF	Overflow	0
30	UF	Underflow	0
31	DO	Denormalized operand error	0

## Exception Data Register (EDR)

The Exception Data Register stores data read on a stream link (FSL or AXI) that caused a stream exception.

The contents of this register is undefined for all other exceptions. When read with the MFS instruction, the EDR is specified by setting  $Sa = 0x000D$ . [Figure 2-9](#) illustrates the EDR register and [Table 2-15](#) provides bit descriptions and reset values.

**Note:** The register is only implemented if `C_FSL_LINKS` is greater than 0 and `C_FSL_EXCEPTION` is set to 1.



Figure 2-9: EDR

Table 2-15: Exception Data Register (EDR)

Bits	Name	Description	Reset Value
0:31	EDR	Exception Data Register	0x00000000

## Stack Low Register (SLR)

The Stack Low Register stores the stack low limit use to detect stack overflow. When the address of a load or store instruction using the stack pointer (register R1) as rA is less than the Stack Low Register, a stack overflow occurs, causing a Stack Protection Violation exception if exceptions are enabled in MSR.

When read with the MFS instruction, the SLR is specified by setting Sa = 0x0800. [Figure 2-10](#) illustrates the SLR register and [Table 2-16](#) provides bit descriptions and reset values.

**Note:** The register is only implemented if C\_USE\_STACK\_PROTECTION is set to 1.

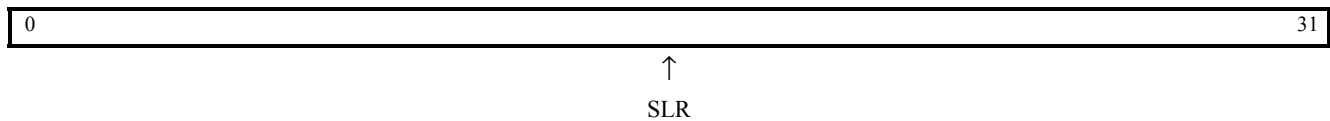

Figure 2-10: SLR

Table 2-16: Stack Low Register (SLR)

Bits	Name	Description	Reset Value
0:31	SLR	Stack Low Register	0x00000000

## Stack High Register (SHR)

The Stack High Register stores the stack high limit use to detect stack underflow. When the address of a load or store instruction using the stack pointer (register R1) as rA is greater than the Stack High Register, a stack underflow occurs, causing a Stack Protection Violation exception if exceptions are enabled in MSR.

When read with the MFS instruction, the SHR is specified by setting Sa = 0x0802. [Figure 2-11](#) illustrates the SHR register and [Table 2-17](#) provides bit descriptions and reset values.

**Note:** The register is only implemented if C\_USE\_STACK\_PROTECTION is set to 1.

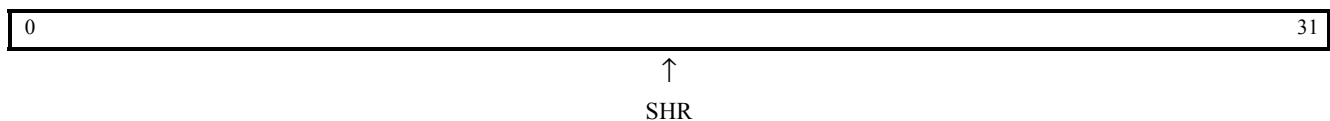

Figure 2-11: SHR

Table 2-17: Stack High Register (SHR)

Bits	Name	Description	Reset Value
0:31	SHR	Stack High Register	0xFFFFFFFF

## Process Identifier Register (PID)

The Process Identifier Register is used to uniquely identify a software process during MMU address translation. It is controlled by the `C_USE_MMU` configuration option on MicroBlaze. The register is only implemented if `C_USE_MMU` is greater than 1 (User Mode) and `C_AREA_OPTIMIZED` is set to 0. When accessed with the MFS and MTS instructions, the PID is specified by setting `Sa = 0x1000`. The register is accessible according to the memory management special registers parameter `C_MMU_TLB_ACCESS`.

PID is also used when accessing a TLB entry:

- When writing Translation Look-Aside Buffer High (TLBHI) the value of PID is stored in the TID field of the TLB entry
- When reading TLBHI and `MSR[UM]` is not set, the value in the TID field is stored in PID

Figure 2-12 illustrates the PID register and Table 2-18 provides bit descriptions and reset values.



Figure 2-12: PID

Table 2-18: Process Identifier Register (PID)

Bits	Name	Description	Reset Value
0:23	Reserved		
24:31	PID	Used to uniquely identify a software process during MMU address translation. Read/Write	0x00

## Zone Protection Register (ZPR)

The Zone Protection Register is used to override MMU memory protection defined in TLB entries. It is controlled by the C\_USE\_MMU configuration option on MicroBlaze. The register is only implemented if C\_USE\_MMU is greater than 1 (User Mode), C\_AREA\_OPTIMIZED is set to 0, and if the number of specified memory protection zones is greater than zero (C\_MMU\_ZONES > 0). The implemented register bits depend on the number of specified memory protection zones (C\_MMU\_ZONES). When accessed with the MFS and MTS instructions, the ZPR is specified by setting Sa = 0x1001. The register is accessible according to the memory management special registers parameter C\_MMU\_TLB\_ACCESS. Figure 2-13 illustrates the ZPR register and Table 2-19 provides bit descriptions and reset values.

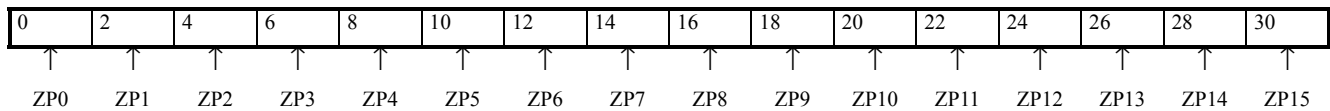

Figure 2-13: ZPR

Table 2-19: Zone Protection Register (ZPR)

Bits	Name	Description	Reset Value
0:1	ZP0	Zone Protect	0x00000000
2:3	ZP1	User mode (MSR[UM] = 1):	
...	...	00 = Override V in TLB entry. No access to the page is allowed	
30:31	ZP15	01 = No override. Use V, WR and EX from TLB entry	
		10 = No override. Use V, WR and EX from TLB entry	
		11 = Override WR and EX in TLB entry. Access the page as writable and executable	
		Privileged mode (MSR[UM] = 0):	
		00 = No override. Use V, WR and EX from TLB entry	
		01 = No override. Use V, WR and EX from TLB entry	
		10 = Override WR and EX in TLB entry. Access the page as writable and executable	
		11 = Override WR and EX in TLB entry. Access the page as writable and executable	
		Read/Write	

## Translation Look-Aside Buffer Low Register (TLBLO)

The Translation Look-Aside Buffer Low Register is used to access MMU Unified Translation Look-Aside Buffer (UTLB) entries. It is controlled by the `C_USE_MMU` configuration option on MicroBlaze. The register is only implemented if `C_USE_MMU` is greater than 1 (User Mode), and `C_AREA_OPTIMIZED` is set to 0. When accessed with the MFS and MTS instructions, the TLBLO is specified by setting `Sa = 0x1003`. When reading or writing TLBLO, the UTLB entry indexed by the TLBX register is accessed. The register is readable according to the memory management special registers parameter `C_MMU_TLB_ACCESS`.

The UTLB is reset on bit stream download (reset value is 0x00000000 for all TLBLO entries).

**Note:** The UTLB is **not** reset by the external reset inputs: `Reset`, `MB_Reset` and `Debug_Rst`.

Figure 2-14 illustrates the TLBLO register and Table 2-20 provides bit descriptions and reset values.

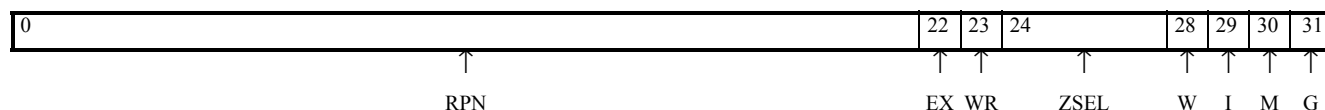

Figure 2-14: TLBLO

Table 2-20: Translation Look-Aside Buffer Low Register (TLBLO)

Bits	Name	Description	Reset Value
0:21	RPN	Real Page Number or Physical Page Number When a TLB hit occurs, this field is read from the TLB entry and is used to form the physical address. Depending on the value of the SIZE field, some of the RPN bits are not used in the physical address. Software must clear unused bits in this field to zero. Only defined when <code>C_USE_MMU=3</code> (Virtual). Read/Write	0x000000
22	EX	Executable When bit is set to 1, the page contains executable code, and instructions can be fetched from the page. When bit is cleared to 0, instructions cannot be fetched from the page. Attempts to fetch instructions from a page with a clear EX bit cause an instruction-storage exception. Read/Write	0

Table 2-20: Translation Look-Aside Buffer Low Register (TLBLO) (Continued)

Bits	Name	Description	Reset Value
23	WR	<p>Writable</p> <p>When bit is set to 1, the page is writable and store instructions can be used to store data at addresses within the page.</p> <p>When bit is cleared to 0, the page is read-only (not writable). Attempts to store data into a page with a clear WR bit cause a data storage exception.</p> <p>Read/Write</p>	0
24:27	ZSEL	<p>Zone Select</p> <p>This field selects one of 16 zone fields (Z0-Z15) from the zone-protection register (ZPR).</p> <p>For example, if ZSEL 0x5, zone field Z5 is selected. The selected ZPR field is used to modify the access protection specified by the TLB entry EX and WR fields. It is also used to prevent access to a page by overriding the TLB V (valid) field.</p> <p>Read/Write</p>	0x0
28	W	<p>Write Through</p> <p>When the parameter C_DCACHE_USE_WRITEBACK is set to 1, this bit controls caching policy. A write-through policy is selected when set to 1, and a write-back policy is selected otherwise.</p> <p>This bit is fixed to 1, and write-through is always used, when C_DCACHE_USE_WRITEBACK is cleared to 0.</p> <p>Read/Write</p>	0/1
29	I	<p>Inhibit Caching</p> <p>When bit is set to 1, accesses to the page are not cached (caching is inhibited).</p> <p>When cleared to 0, accesses to the page are cacheable.</p> <p>Read/Write</p>	0
30	M	<p>Memory Coherent</p> <p>This bit is fixed to 0, because memory coherence is not implemented on MicroBlaze.</p> <p>Read Only</p>	0
31	G	<p>Guarded</p> <p>When bit is set to 1, speculative page accesses are not allowed (memory is guarded).</p> <p>When cleared to 0, speculative page accesses are allowed.</p> <p>The G attribute can be used to protect memory-mapped I/O devices from inappropriate instruction accesses.</p> <p>Read/Write</p>	0

## Translation Look-Aside Buffer High Register (TLBHI)

The Translation Look-Aside Buffer High Register is used to access MMU Unified Translation Look-Aside Buffer (UTLB) entries. It is controlled by the `C_USE_MMU` configuration option on MicroBlaze. The register is only implemented if `C_USE_MMU` is greater than 1 (User Mode), and `C_AREA_OPTIMIZED` is set to 0. When accessed with the MFS and MTS instructions, the TLBHI is specified by setting `Sa = 0x1004`. When reading or writing TLBHI, the UTLB entry indexed by the TLBX register is accessed. The register is readable according to the memory management special registers parameter `C_MMU_TLB_ACCESS`.

PID is also used when accessing a TLB entry:

- When writing TLBHI the value of PID is stored in the TID field of the TLB entry
- When reading TLBHI and `MSR[UM]` is not set, the value in the TID field is stored in PID

The UTLB is reset on bit stream download (reset value is 0x00000000 for all TLBHI entries).

**Note:** The UTLB is **not** reset by the external reset inputs: `Reset`, `MB_Reset` and `Debug_Rst`.

Figure 2-15 illustrates the TLBHI register and Table 2-21 provides bit descriptions and reset values.

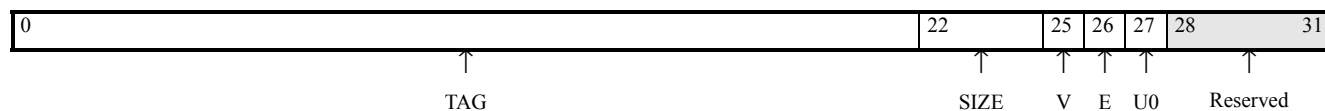

Figure 2-15: TLBHI

Table 2-21: Translation Look-Aside Buffer High Register (TLBHI)

Bits	Name	Description	Reset Value
0:21	TAG	TLB-entry tag Is compared with the page number portion of the virtual memory address under the control of the SIZE field. Read/Write	0x000000
22:24	SIZE	Size Specifies the page size. The SIZE field controls the bit range used in comparing the TAG field with the page number portion of the virtual memory address. The page sizes defined by this field are listed in Table 2-37. Read/Write	000
25	V	Valid When this bit is set to 1, the TLB entry is valid and contains a page-translation entry. When cleared to 0, the TLB entry is invalid. Read/Write	0



**Table 2-21: Translation Look-Aside Buffer High Register (TLBHI) (Continued)**  
**(Continued)**

Bits	Name	Description	Reset Value
26	E	<p>Endian</p> <p>When this bit is set to 1, a the page is accessed as a little endian page if C_ENDIANNES is 0 (Big Endian), or as a big endian page otherwise.</p> <p>When cleared to 0, the page is accessed as a big endian page if C_ENDIANNES is 0 (Big Endian), or as a little endian page otherwise.</p> <p>The E bit only affects data read or data write accesses. Instruction accesses are not affected.</p> <p>The E bit is only implemented when the parameter C_USE_REORDER_INSTR is set to 1, otherwise it is fixed to 0.</p> <p>Read/Write</p>	0
27	U0	<p>User Defined</p> <p>This bit is fixed to 0, since there are no user defined storage attributes on MicroBlaze.</p> <p>Read Only</p>	0
28:31	Reserved		

## Translation Look-Aside Buffer Index Register (TLBX)

The Translation Look-Aside Buffer Index Register is used as an index to the Unified Translation Look-Aside Buffer (UTLB) when accessing the TLBLO and TLBHI registers. It is controlled by the `C_USE_MMU` configuration option on MicroBlaze. The register is only implemented if `C_USE_MMU` is greater than 1 (User Mode), and `C_AREA_OPTIMIZED` is set to 0. When accessed with the MFS and MTS instructions, the TLBX is specified by setting `Sa = 0x1002`. [Figure 2-16](#) illustrates the TLBX register and [Table 2-22](#) provides bit descriptions and reset values.

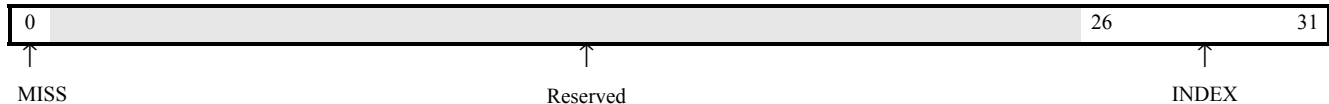

Figure 2-16: TLBX

Table 2-22: Translation Look-Aside Buffer Index Register (TLBX)

Bits	Name	Description	Reset Value
0	MISS	<p>TLB Miss</p> <p>This bit is cleared to 0 when the TLBSX register is written with a virtual address, and the virtual address is found in a TLB entry. The bit is set to 1 if the virtual address is not found. It is also cleared when the TLBX register itself is written.</p> <p>Read Only</p> <p>Can be read if the memory management special registers parameter <code>C_MMU_TLB_ACCESS &gt; 0</code> (MINIMAL).</p>	0
1:25	Reserved		
26:31	INDEX	<p>TLB Index</p> <p>This field is used to index the Translation Look-Aside Buffer entry accessed by the TLBLO and TLBHI registers. The field is updated with a TLB index when the TLBSX register is written with a virtual address, and the virtual address is found in the corresponding TLB entry.</p> <p>Read/Write</p> <p>Can be read and written if the memory management special registers parameter <code>C_MMU_TLB_ACCESS &gt; 0</code> (MINIMAL).</p>	000000

### Translation Look-Aside Buffer Search Index Register (TLBSX)

The Translation Look-Aside Buffer Search Index Register is used to search for a virtual page number in the Unified Translation Look-Aside Buffer (UTLB). It is controlled by the C\_USE\_MMU configuration option on MicroBlaze. The register is only implemented if C\_USE\_MMU is greater than 1 (User Mode), and C\_AREA\_OPTIMIZED is set to 0. When written with the MTS instruction, the TLBSX is specified by setting Sa = 0x1005. Figure 2-17 illustrates the TLBSX register and Table 2-23 provides bit descriptions and reset values.

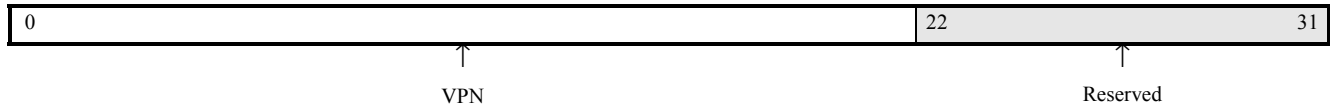

Figure 2-17: TLBSX

Table 2-23: Translation Look-Aside Buffer Index Search Register (TLBSX)

Bits	Name	Description	Reset Value
0:21	VPN	<p>Virtual Page Number</p> <p>This field represents the page number portion of the virtual memory address. It is compared with the page number portion of the virtual memory address under the control of the SIZE field, in each of the Translation Look-Aside Buffer entries that have the V bit set to 1.</p> <p>If the virtual page number is found, the TLBX register is written with the index of the TLB entry and the MISS bit in TLBX is cleared to 0. If the virtual page number is not found in any of the TLB entries, the MISS bit in the TLBX register is set to 1.</p> <p>Write Only</p>	
22:31	Reserved		

## Processor Version Register (PVR)

The Processor Version Register is controlled by the C\_PVR configuration option on MicroBlaze.

- When C\_PVR is set to 0 (None) the processor does not implement any PVR and MSR[PVR]=0.
- When C\_PVR is set to 1 (Basic), MicroBlaze implements only the first register: PVR0, and if set to 2 (Full), all 13 PVR registers (PVR0 to PVR12) are implemented.

When read with the MFS instruction the PVR is specified by setting Sa = 0x200x, with x being the register number between 0x0 and 0xB.

Table 2-24 through Table 2-35 provide bit descriptions and values.

**Table 2-24: Processor Version Register 0 (PVR0)**

Bits	Name	Description	Value
0	CFG	PVR implementation: 0 = Basic, 1 = Full	Based on C_PVR
1	BS	Use barrel shifter	C_USE_BARREL
2	DIV	Use divider	C_USE_DIV
3	MUL	Use hardware multiplier	C_USE_HW_MUL > 0 (None)
4	FPU	Use FPU	C_USE_FPU > 0 (None)
5	EXC	Use any type of exceptions	Based on C_*_EXCEPTION Also set if C_USE_MMU > 0 (None)
6	ICU	Use instruction cache	C_USE_ICACHE
7	DCU	Use data cache	C_USE_DCACHE
8	MMU	Use MMU	C_USE_MMU > 0 (None)
9	BTC	Use branch target cache	C_USE_BRANCH_TARGET_CACHE
10	ENDI	Selected endianness: 0 = Big endian, 1 = Little endian	C_ENDIANNES
11	FT	Implement fault tolerant features	C_FAULT_TOLERANT
12	SPROT	Use stack protection	C_USE_STACK_PROTECTION
13	REORD	Implement reorder instructions	C_USE_REORDER_INSTR
14:15	Reserved		0
16:23	MBV	MicroBlaze release version code 0x1 = v5.00.a      0xF = v7.20.d 0x2 = v5.00.b      0x10 = v7.30.a 0x3 = v5.00.c      0x11 = v7.30.b 0x4 = v6.00.a      0x12 = v8.00.a 0x6 = v6.00.b      0x13 = v8.00.b 0x5 = v7.00.a      0x14 = v8.10.a 0x7 = v7.00.b      0x15 = v8.20.a 0x8 = v7.10.a      0x16 = v8.20.b 0x9 = v7.10.b      0x17 = v8.30.a 0xA = v7.10.c      0x18 = v8.40.a 0xB = v7.10.d      0x19 = v8.40.b 0xC = v7.20.a      0x1A = v8.50.a 0xD = v7.20.b      0x1C = v8.50.b 0xE = v7.20.c      0x1E = v8.50.c	Release Specific
24:31	USR1	User configured value 1	C_PVR_USER1

Table 2-25: Processor Version Register 1 (PVR1)

Bits	Name	Description	Value
0:31	USR2	User configured value 2	C_PVR_USER2

Table 2-26: Processor Version Register 2 (PVR2)

Bits	Name	Description	Value
0	DAXI	Data side AXI4 or ACE in use	C_D_AXI
1	DLMB	Data side LMB in use	C_D_LMB
2	IAXI	Instruction side AXI4 or ACE in use	C_I_AXI
3	ILMB	Instruction side LMB in use	C_I_LMB
4	IRQEDGE	Interrupt is edge triggered	C_INTERRUPT_IS_EDGE
5	IRQPOS	Interrupt edge is positive	C_EDGE_IS_POSITIVE
6	DPLB	Data side PLB in use	C_D_PLB
7	IPLB	Instruction side PLB in use	C_I_PLB
8	INTERCON	Use PLB interconnect	C_INTERCONNECT = 1 (PLBv46)
9	STREAM	Use AXI4-Stream interconnect	C_STREAM_INTERCONNECT = 1 (AXI4-Stream)
10	ACE	Use ACE interconnect	C_INTERCONNECT = 3 (ACE)
11	AXI4DP	Data Peripheral AXI interface uses AXI4 protocol, with support for exclusive access	C_M_AXI_DP_EXCLUSIVE_ACCESS
12	FSL	Use extended stream (FSL or AXI) instructions	C_USE_EXTENDED_FSL_INSTR
13	FSLEXC	Generate exception for stream control bit (FSL or AXI) mismatch	C_FSL_EXCEPTION
14	MSR	Use msrset and msrclr instructions	C_USE_MSR_INSTR
15	PCMP	Use pattern compare and CLZ instructions	C_USE_PCMP_INSTR
16	AREA	Select implementation to optimize area with lower instruction throughput	C_AREA_OPTIMIZED
17	BS	Use barrel shifter	C_USE_BARREL
18	DIV	Use divider	C_USE_DIV
19	MUL	Use hardware multiplier	C_USE_HW_MUL > 0 (None)

Table 2-26: Processor Version Register 2 (PVR2) (Continued)

Bits	Name	Description	Value
20	FPU	Use FPU	C_USE_FPU > 0 (None)
21	MUL64	Use 64-bit hardware multiplier	C_USE_HW_MUL = 2 (Mul64)
22	FPU2	Use floating point conversion and square root instructions	C_USE_FPU = 2 (Extended)
23	IPLBEXC	Generate exception for IPLB error	C_IPLB_BUS_EXCEPTION
24	DPLBEXC	Generate exception for DPLB error	C_DPLB_BUS_EXCEPTION
25	OP0EXC	Generate exception for 0x0 illegal opcode	C_OPCODE_0x0_ILLEGAL
26	UNEXC	Generate exception for unaligned data access	C_UNALIGNED_EXCEPTIONS
27	OPEXC	Generate exception for any illegal opcode	C_ILL_OPCODE_EXCEPTION
28	AXIEXC	Generate exception for M_AXI_I error	C_M_AXI_I_BUS_EXCEPTION
29	AXIDEXC	Generate exception for M_AXI_D error	C_M_AXI_D_BUS_EXCEPTION
30	DIVEXC	Generate exception for division by zero or division overflow	C_DIV_ZERO_EXCEPTION
31	FPUEXC	Generate exceptions from FPU	C_FPU_EXCEPTION

Table 2-27: Processor Version Register 3 (PVR3)

Bits	Name	Description	Value
0	DEBUG	Use debug logic	C_DEBUG_ENABLED
1:2	Reserved		
3:6	PCBRK	Number of PC breakpoints	C_NUMBER_OF_PC_BRK
7:9	Reserved		
10:12	RDADDR	Number of read address breakpoints	C_NUMBER_OF_RD_ADDR_BRK
13:15	Reserved		
16:18	WRADDR	Number of write address breakpoints	C_NUMBER_OF_WR_ADDR_BRK
19	Reserved		

**Table 2-27: Processor Version Register 3 (PVR3) (Continued)**

Bits	Name	Description	Value
20:24	FSL	Number of stream links	C_FSL_LINKS
25:28	Reserved		
29:31	BTC_SIZE	Branch Target Cache size	C_BRANCH_TARGET_CACHE_SIZE

**Table 2-28: Processor Version Register 4 (PVR4)**

Bits	Name	Description	Value
0	ICU	Use instruction cache	C_USE_ICACHE
1:5	ICTS	Instruction cache tag size	C_ADDR_TAG_BITS
6	Reserved		1
7	ICW	Allow instruction cache write	C_ALLOW_ICACHE_WR
8:10	ICLL	The base two logarithm of the instruction cache line length	$\log_2(C\_ICACHE\_LINE\_LEN)$
11:15	ICBS	The base two logarithm of the instruction cache byte size	$\log_2(C\_CACHE\_BYTE\_SIZE)$
16	IAU	The instruction cache is used for all memory accesses within the cacheable range	C_ICACHE_ALWAYS_USED
17	Reserved		0
18	ICI	Instruction cache XCL protocol	C_ICACHE_INTERFACE
19:21	ICV	Instruction cache victims	0-3: C_ICACHE_VICTIMS = 0,2,4,8
22:23	ICS	Instruction cache streams	C_ICACHE_STREAMS
24	IFTL	Instruction cache tag uses distributed RAM	C_ICACHE_FORCE_TAG_LUTRAM
25	ICDW	Instruction cache data width	C_ICACHE_DATA_WIDTH > 0
26:31	Reserved		0

**Table 2-29: Processor Version Register 5 (PVR5)**

Bits	Name	Description	Value
0	DCU	Use data cache	C_USE_DCACHE
1:5	DCTS	Data cache tag size	C_DCACHE_ADDR_TAG
6	Reserved		1
7	DCW	Allow data cache write	C_ALLOW_DCACHE_WR
8:10	DCLL	The base two logarithm of the data cache line length	$\log_2(C\_DCACHE\_LINE\_LEN)$

Table 2-29: Processor Version Register 5 (PVR5) (Continued)

Bits	Name	Description	Value
11:15	DCBS	The base two logarithm of the data cache byte size	$\log_2(C\_DCACHE\_BYTE\_SIZE)$
16	DAU	The data cache is used for all memory accesses within the cacheable range	C_DCACHE_ALWAYS_USED
17	DWB	Data cache policy is write-back	C_DCACHE_USE_WRITEBACK
18	DCI	Data cache XCL protocol	C_DCACHE_INTERFACE
19:21	DCV	Data cache victims	0-3: C_DCACHE_VICTIMS = 0,2,4,8
22:23	Reserved		0
24	DFTL	Data cache tag uses distributed RAM	C_DCACHE_FORCE_TAG_LUTRAM
25	DCDW	Data cache data width	C_DCACHE_DATA_WIDTH > 0
26	AXI4DC	Data Cache AXI interface uses AXI4 protocol, with support for exclusive access	C_M_AXI_DC_EXCLUSIVE_ACCESS
27:31	Reserved		0

Table 2-30: Processor Version Register 6 (PVR6)

Bits	Name	Description	Value
0:31	ICBA	Instruction Cache Base Address	C_ICACHE_BASEADDR

Table 2-31: Processor Version Register 7 (PVR7)

Bits	Name	Description	Value
0:31	ICHA	Instruction Cache High Address	C_ICACHE_HIGHADDR

Table 2-32: Processor Version Register 8 (PVR8)

Bits	Name	Description	Value
0:31	DCBA	Data Cache Base Address	C_DCACHE_BASEADDR

Table 2-33: Processor Version Register 9 (PVR9)

Bits	Name	Description	Value
0:31	DCHA	Data Cache High Address	C_DCACHE_HIGHADDR



Table 2-34: Processor Version Register 10 (PVR10)

Bits	Name	Description	Value
0:7	ARCH	Target architecture: 0x6 = Spartan®-3, Automotive Spartan-3 0x7 = Virtex-4, Defence Grade Virtex-4 Q Space-Grade Virtex-4 QV 0x8 = Virtex-5, Defence Grade Virtex-5 Q Space-Grade Virtex-5 QV 0x9 = Spartan-3E, Automotive Spartan-3E 0xA = Spartan-3A, Automotive Spartan-3A 0xB = Spartan-3AN 0xC = Spartan-3A DSP, Automotive Spartan-3A DSP 0xD = Spartan-6, Automotive Spartan-6, Defence Grade Spartan-6 Q 0xE = Virtex-6, Defence Grade Virtex-6 Q 0xF = Virtex-7, Defence Grade Virtex-7 Q 0x10 = Kintex™-7, Defence Grade Kintex-7 Q 0x11 = Artix™-7, Automotive Artix-7, Defence Grade Artix-7 Q 0x12 = Zynq™-7000, Automotive Zynq-7000, Defence Grade Zynq-7000 Q	Defined by parameter C_FAMILY
8:31	Reserved		0

Table 2-35: Processor Version Register 11 (PVR11)

Bits	Name	Description	Value
0:1	MMU	Use MMU: 0 = None                      2 = Protection 1 = User Mode                3 = Virtual	C_USE_MMU
2:4	ITLB	Instruction Shadow TLB size	log2 (C_MMU_ITLB_SIZE)
5:7	DTLB	Data Shadow TLB size	log2 (C_MMU_DTLB_SIZE)
8:9	TLBACC	TLB register access: 0 = Minimal                  2 = Write 1 = Read                      3 = Full	C_MMU_TLB_ACCESS
10:14	ZONES	Number of memory protection zones	C_MMU_ZONES
15	PRIVINS	Privileged instructions: 0 = Full protection 1 = Allow stream instructions	C_MMU_PRIVILEGED_INSTR
16:16	Reserved	Reserved for future use	0
17:31	RSTMSR	Reset value for MSR	C_RESET_MSR

Table 2-36: Processor Version Register 12 (PVR12)

Bits	Name	Description	Value
0:31	VECTORS	Location of MicroBlaze vectors	C_BASE_VECTORS

# Pipeline Architecture

MicroBlaze instruction execution is pipelined. For most instructions, each stage takes one clock cycle to complete. Consequently, the number of clock cycles necessary for a specific instruction to complete is equal to the number of pipeline stages, and one instruction is completed on every cycle. A few instructions require multiple clock cycles in the execute stage to complete. This is achieved by stalling the pipeline.

When executing from slower memory, instruction fetches may take multiple cycles. This additional latency directly affects the efficiency of the pipeline. MicroBlaze implements an instruction prefetch buffer that reduces the impact of such multi-cycle instruction memory latency. While the pipeline is stalled by a multi-cycle instruction in the execution stage, the prefetch buffer continues to load sequential instructions. When the pipeline resumes execution, the fetch stage can load new instructions directly from the prefetch buffer instead of waiting for the instruction memory access to complete. If instructions are modified during execution (e.g. with self-modifying code), the prefetch buffer should be emptied before executing the modified instructions, to ensure that it does not contain the old unmodified instructions. The recommended way to do this is using an MBAR instruction, although it is also possible to use a synchronizing branch instruction, for example BRI 4.

## Three Stage Pipeline

With `C_AREA_OPTIMIZED` set to 1, the pipeline is divided into three stages to minimize hardware cost: Fetch, Decode, and Execute.

	cycle1	cycle2	cycle3	cycle4	cycle5	cycle6	cycle7
instruction 1	Fetch	Decode	Execute				
instruction 2		Fetch	Decode	Execute	Execute	Execute	
instruction 3			Fetch	Decode	Stall	Stall	Execute

## Five Stage Pipeline

With `C_AREA_OPTIMIZED` set to 0, the pipeline is divided into five stages to maximize performance: Fetch (IF), Decode (OF), Execute (EX), Access Memory (MEM), and Writeback (WB).

	cycle1	cycle2	cycle3	cycle4	cycle5	cycle6	cycle7	cycle8	cycle9
instruction 1	IF	OF	EX	MEM	WB				
instruction 2		IF	OF	EX	MEM	MEM	MEM	WB	
instruction 3			IF	OF	EX	Stall	Stall	MEM	WB

## Branches

Normally the instructions in the fetch and decode stages (as well as prefetch buffer) are flushed when executing a taken branch. The fetch pipeline stage is then reloaded with a new instruction from the calculated branch address. A taken branch in MicroBlaze takes three clock cycles to execute, two of which are required for refilling the pipeline. To reduce this latency overhead, MicroBlaze supports branches with delay slots.

## Delay Slots

When executing a taken branch with delay slot, only the fetch pipeline stage in MicroBlaze is flushed. The instruction in the decode stage (branch delay slot) is allowed to complete. This technique effectively reduces the branch penalty from two clock cycles to one. Branch instructions with delay slots have a D appended to the instruction mnemonic. For example, the BNE instruction does not execute the subsequent instruction (does not have a delay slot), whereas BNED executes the next instruction before control is transferred to the branch location.

A delay slot must not contain the following instructions: IMM, branch, or break. Interrupts and external hardware breaks are deferred until after the delay slot branch has been completed.

Instructions that could cause recoverable exceptions (e.g. unaligned word or halfword load and store) are allowed in the delay slot. If an exception is caused in a delay slot the ESR[DS] bit is set, and the exception handler is responsible for returning the execution to the branch target (stored in the special purpose register BTR). If the ESR[DS] bit is set, register R17 is not valid (otherwise it contains the address following the instruction causing the exception).

## Branch Target Cache

To improve branch performance, MicroBlaze provides a Branch Target Cache (BTC) coupled with a branch prediction scheme. With the BTC enabled, a correctly predicted immediate branch or return instruction incurs no overhead.

The BTC operates by saving the target address of each immediate branch and return instruction the first time the instruction is encountered. The next time it is encountered, it is usually found in the Branch Target Cache, and the Instruction Fetch Program Counter is then simply changed to the saved target address, in case the branch should be taken. Unconditional branches and return instructions are always taken, whereas conditional branches use branch prediction, to avoid taking a branch that should not have been taken and vice versa.

The BTC is cleared when a memory barrier (MBAR 0) or synchronizing branch (BRI 4) is executed. This also occurs when the memory barrier or synchronizing branch follows immediately after a branch instruction, even if that branch is taken. To avoid inadvertently clearing the BTC, the memory barrier or synchronizing branch should not be placed immediately after a branch instruction.

There are three cases where the branch prediction can cause a mispredict, namely:

- A conditional branch that should not have been taken, is actually taken,
- A conditional branch that should actually have been taken, is not taken,
- The target address of a return instruction is incorrect, which may occur when returning from a function called from different places in the code.

All of these cases are detected and corrected when the branch or return instruction reaches the execute stage, and the branch prediction bits or target address are updated in the BTC, to reflect the actual instruction behavior. This correction incurs a penalty of two clock cycles.

The size of the BTC can be selected with `C_BRANCH_TARGET_CACHE_SIZE`. The default recommended setting uses one block RAM, and provides either 512 entries (for Virtex-5, Virtex-6, and 7 Series) or 256 entries (for all other families). When selecting 64 entries or below, distributed RAM is used to implement the BTC, otherwise block RAM is used.

When the BTC uses block RAM, and `C_FAULT_TOLERANT` is set to 1, block RAMs are protected by parity. In case of a parity error, the branch is not predicted. To avoid accumulating errors in this case, the BTC should be cleared periodically by a synchronizing branch.

The Branch Target Cache is available when `C_USE_BRANCH_TARGET_CACHE` is set to 1 and `C_AREA_OPTIMIZED` is set to 0.

## Memory Architecture

MicroBlaze is implemented with a Harvard memory architecture; instruction and data accesses are done in separate address spaces. Each address space has a 32-bit range (that is, handles up to 4-GB of instructions and data memory respectively). The instruction and data memory ranges can be made to overlap by mapping them both to the same physical memory. The latter is useful for software debugging.

Both instruction and data interfaces of MicroBlaze are default 32 bits wide and use big endian or little endian, bit-reversed format, depending on the parameter `C_ENDIANNES`. MicroBlaze supports word, halfword, and byte accesses to data memory.

Data accesses must be aligned (word accesses must be on word boundaries, halfword on halfword boundaries), unless the processor is configured to support unaligned exceptions. All instruction accesses must be word aligned.

MicroBlaze prefetches instructions to improve performance, using the instruction prefetch buffer and (if enabled) instruction cache streams. To avoid attempts to prefetch instructions beyond the end of physical memory, which may cause an instruction bus error or a processor stall, instructions must not be located too close to the end of physical memory. The instruction prefetch buffer requires 16 bytes margin, and using instruction cache streams adds two additional cache lines (32 or 64 bytes).

MicroBlaze does not separate data accesses to I/O and memory (it uses memory mapped I/O). The processor has up to three interfaces for memory accesses:

- Local Memory Bus (LMB)
- Advanced eXtensible Interface (AXI4) or Processor Local Bus (PLB)
- Advanced eXtensible Interface (AXI4) or Xilinx CacheLink (XCL)

The LMB memory address range must not overlap with AXI4, PLB or XCL ranges.

The `C_ENDIANNES` parameter is automatically set to little endian when using AXI4, and to big endian when using PLB, but can be overridden by the user.

MicroBlaze has a single cycle latency for accesses to local memory (LMB) and for cache read hits, except with `C_AREA_OPTIMIZED` set to 1, when data side accesses and data cache read hits require two clock cycles, and with `C_FAULT_TOLERANT` set to 1, when byte writes and halfword writes to LMB normally require two clock cycles.

The data cache write latency depends on `C_DCACHE_USE_WRITEBACK`. When `C_DCACHE_USE_WRITEBACK` is set to 1, the write latency normally is one cycle (more if the cache needs to do memory accesses). When `C_DCACHE_USE_WRITEBACK` is cleared to 0, the write latency normally is two cycles (more if the posted-write buffer in the memory controller is full).

The MicroBlaze instruction and data caches can be configured to use 4 or 8 word cache lines. When using a longer cache line, more bytes are prefetched, which generally improves performance for software with sequential access patterns. However, for software with a more random access pattern the performance can instead decrease for a given cache size. This is caused by a reduced cache hit rate due to fewer available cache lines.

For details on the different memory interfaces refer to [Chapter 3, MicroBlaze Signal Interface Description](#).

## Privileged Instructions

The following MicroBlaze instructions are privileged:

- GET, GETD, PUT, PUTD (except when explicitly allowed)
- WIC, WDC
- MTS
- MSRCLR, MSRSET (except when only the C bit is affected)
- BRK
- RTID, RTBD, RTED
- BRKI (except when jumping to physical address  $C\_BASE\_VECTORS + 0x8$  or  $C\_BASE\_VECTORS + 0x18$ )
- SLEEP

Attempted use of these instructions when running in user mode causes a privileged instruction exception.

When setting the parameter `C_MMU_PRIVILEGED_INSTR` to 1, the instructions GET, GETD, PUT, and PUTD are not considered privileged, and can be executed when running in user mode. It is strongly discouraged to do this, unless absolutely necessary for performance reasons, since it allows application programs to interfere with each other.

There are six ways to leave user mode and virtual mode:

1. Hardware generated reset (including debug reset)
2. Hardware exception
3. Non-maskable break or hardware break
4. Interrupt
5. Executing "BRALID  $Re, C\_BASE\_VECTORS + 0x8$ " to perform a user vector exception
6. Executing the software break instructions "BRKI" jumping to physical address  $C\_BASE\_VECTORS + 0x8$  or  $C\_BASE\_VECTORS + 0x18$

In all of these cases, except hardware generated reset, the user mode and virtual mode status is saved in the MSR UMS and VMS bits.

Application (user-mode) programs transfer control to system-service routines (privileged mode programs) using the BRALID or BRKI instruction, jumping to physical address  $C\_BASE\_VECTORS + 0x8$ . Executing this instruction causes a system-call exception to occur. The exception handler determines which system-service routine to call and whether the calling application has permission to call that service. If permission is granted, the exception handler performs the actual procedure call to the system-service routine on behalf of the application program.

The execution environment expected by the system-service routine requires the execution of prologue instructions to set up that environment. Those instructions usually create the block of storage that holds procedural information (the activation record), update and initialize pointers, and save volatile registers (registers the system-service routine uses). Prologue code can be inserted by the linker when creating an executable module, or it can be included as stub code in either the system-call interrupt handler or the system-library routines.

Returns from the system-service routine reverse the process described above. Epilog code is executed to unwind and deallocate the activation record, restore pointers, and restore volatile registers. The interrupt handler executes a return from exception instruction (RTED) to return to the application.

## Virtual-Memory Management

Programs running on MicroBlaze use effective addresses to access a flat 4 GB address space. The processor can interpret this address space in one of two ways, depending on the translation mode:

- In real mode, effective addresses are used to directly access physical memory
- In virtual mode, effective addresses are translated into physical addresses by the virtual-memory management hardware in the processor

Virtual mode provides system software with the ability to relocate programs and data anywhere in the physical address space. System software can move inactive programs and data out of physical memory when space is required by active programs and data.

Relocation can make it appear to a program that more memory exists than is actually implemented by the system. This frees the programmer from working within the limits imposed by the amount of physical memory present in a system. Programmers do not need to know which physical-memory addresses are assigned to other software processes and hardware devices. The addresses visible to programs are translated into the appropriate physical addresses by the processor.

Virtual mode provides greater control over memory protection. Blocks of memory as small as 1 KB can be individually protected from unauthorized access. Protection and relocation enable system software to support multitasking. This capability gives the appearance of simultaneous or near-simultaneous execution of multiple programs.

In MicroBlaze, virtual mode is implemented by the memory-management unit (MMU), available when `C_USE_MMU` is set to 3 (Virtual) and `C_AREA_OPTIMIZED` is set to 0. The MMU controls effective-address to physical-address mapping and supports memory protection. Using these capabilities, system software can implement demand-paged virtual memory and other memory management schemes.

The MicroBlaze MMU implementation is based upon PowerPC™ 405. For details, see the [PowerPC Processor Reference Guide \(UG011\)](#) document.

The MMU features are summarized as follows:

- Translates effective addresses into physical addresses
- Controls page-level access during address translation
- Provides additional virtual-mode protection control through the use of zones
- Provides independent control over instruction-address and data-address translation and protection
- Supports eight page sizes: 1 kB, 4 kB, 16 kB, 64 kB, 256 kB, 1 MB, 4 MB, and 16 MB. Any combination of page sizes can be used by system software
- Software controls the page-replacement strategy

### Real Mode

The processor references memory when it fetches an instruction and when it accesses data with a load or store instruction. Programs reference memory locations using a 32-bit effective address calculated by the processor. When real mode is enabled, the physical address is identical to the effective address and the processor uses it to access physical memory. After a processor reset, the processor operates in real mode. Real mode can also be enabled by clearing the VM bit in the MSR.

Physical-memory data accesses (loads and stores) are performed in real mode using the effective address. Real mode does not provide system software with virtual address translation, but the full memory access-protection is available, implemented when `C_USE_MMU > 1` (User Mode) and `C_AREA_OPTIMIZED = 0`. Implementation of a real-mode memory manager is more

straightforward than a virtual-mode memory manager. Real mode is often an appropriate solution for memory management in simple embedded environments, when access-protection is necessary, but virtual address translation is not required.

## Virtual Mode

In virtual mode, the processor translates an effective address into a physical address using the process shown in [Figure 2-18](#). Virtual mode can be enabled by setting the VM bit in the MSR.

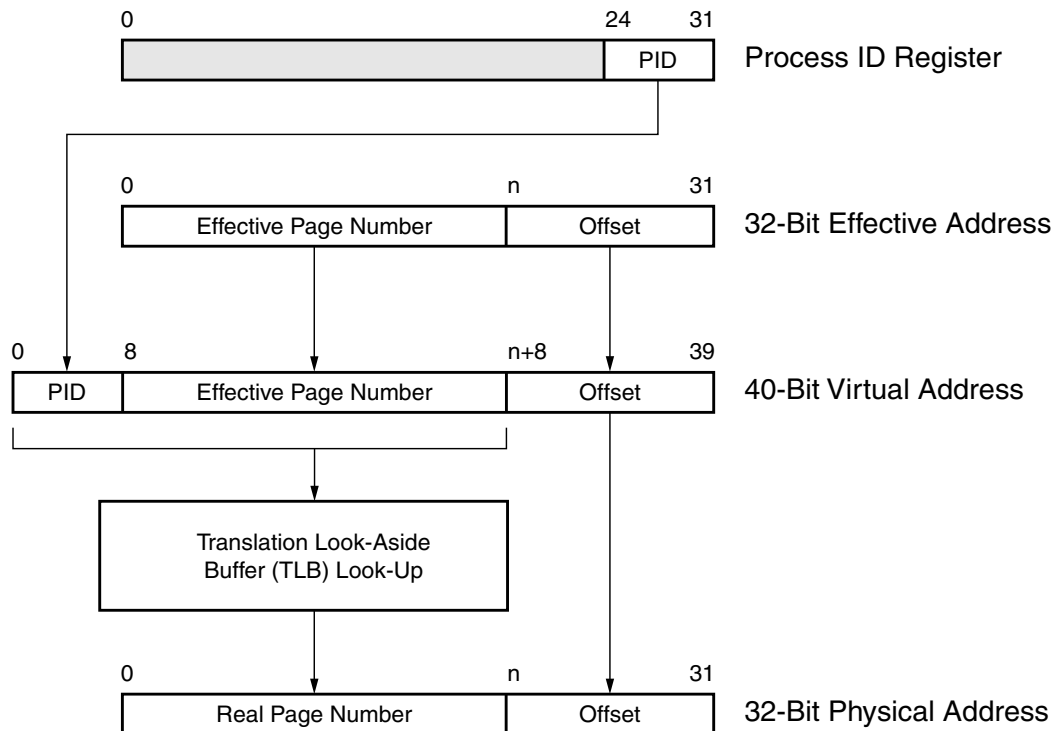

UG011\_37\_021302

**Figure 2-18: Virtual-Mode Address Translation**

Each address shown in [Figure 2-18](#) contains a page-number field and an offset field. The page number represents the portion of the address translated by the MMU. The offset represents the byte offset into a page and is not translated by the MMU. The virtual address consists of an additional field, called the process ID (PID), which is taken from the PID register (see Process-ID Register, page 36). The combination of PID and effective page number (EPN) is referred to as the virtual page number (VPN). The value  $n$  is determined by the page size, as shown in [Table 2-37](#).

System software maintains a page-translation table that contains entries used to translate each virtual page into a physical page. The page size defined by a page translation entry determines the size of the page number and offset fields. For example, when a 4 kB page size is used, the page-number field is 20 bits and the offset field is 12 bits. The VPN in this case is 28 bits.

Then the most frequently used page translations are stored in the translation look-aside buffer (TLB). When translating a virtual address, the MMU examines the page-translation entries for a matching VPN (PID and EPN). Rather than examining all entries in the table, only entries contained in the processor TLB are examined. When a page-translation entry is found with a matching VPN, the corresponding physical-page number is read from the entry and combined with the offset to form the 32-bit physical address. This physical address is used by the processor to reference memory.



System software can use the PID to uniquely identify software processes (tasks, subroutines, threads) running on the processor. Independently compiled processes can operate in effective-address regions that overlap each other. This overlap must be resolved by system software if multitasking is supported. Assigning a PID to each process enables system software to resolve the overlap by relocating each process into a unique region of virtual-address space. The virtual-address space mappings enable independent translation of each process into the physical-address space.

## Page-Translation Table

The page-translation table is a software-defined and software-managed data structure containing page translations. The requirement for software-managed page translation represents an architectural trade-off targeted at embedded-system applications. Embedded systems tend to have a tightly controlled operating environment and a well-defined set of application software. That environment enables virtual-memory management to be optimized for each embedded system in the following ways:

- The page-translation table can be organized to maximize page-table search performance (also called table walking) so that a given page-translation entry is located quickly. Most general-purpose processors implement either an indexed page table (simple search method, large page-table size) or a hashed page table (complex search method, small page-table size). With software table walking, any hybrid organization can be employed that suits the particular embedded system. Both the page-table size and access time can be optimized.
- Independent page sizes can be used for application modules, device drivers, system service routines, and data. Independent page-size selection enables system software to more efficiently use memory by reducing fragmentation (unused memory). For example, a large data structure can be allocated to a 16 MB page and a small I/O device-driver can be allocated to a 1 KB page.
- Page replacement can be tuned to minimize the occurrence of missing page translations. As described in the following section, the most-frequently used page translations are stored in the translation look-aside buffer (TLB). Software is responsible for deciding which translations are stored in the TLB and which translations are replaced when a new translation is required. The replacement strategy can be tuned to avoid thrashing, whereby page-translation entries are constantly being moved in and out of the TLB. The replacement strategy can also be tuned to prevent replacement of critical-page translations, a process sometimes referred to as page locking.

The unified 64-entry TLB, managed by software, caches a subset of instruction and data page-translation entries accessible by the MMU. Software is responsible for reading entries from the page-translation table in system memory and storing them in the TLB. The following section describes the unified TLB in more detail. Internally, the MMU also contains shadow TLBs for instructions and data, with sizes configurable by `C_MMU_ITLB_SIZE` and `C_MMU_DTLB_SIZE` respectively.

These shadow TLBs are managed entirely by the processor (transparent to software) and are used to minimize access conflicts with the unified TLB.

## Translation Look-Aside Buffer

The translation look-aside buffer (TLB) is used by the MicroBlaze MMU for address translation when the processor is running in virtual mode, memory protection, and storage control. Each entry within the TLB contains the information necessary to identify a virtual page (PID and effective page number), specify its translation into a physical page, determine the protection characteristics of the page, and specify the storage attributes associated with the page.

The MicroBlaze TLB is physically implemented as three separate TLBs:

- Unified TLB—The UTLB contains 64 entries and is pseudo-associative. Instruction-page and data-page translation can be stored in any UTLB entry. The initialization and management of the UTLB is controlled completely by software.
- Instruction Shadow TLB—The ITLB contains instruction page-translation entries and is fully associative. The page-translation entries stored in the ITLB represent the most-recently accessed instruction-page translations from the UTLB. The ITLB is used to minimize contention between instruction translation and UTLB-update operations. The initialization and management of the ITLB is controlled completely by hardware and is transparent to software.
- Data Shadow TLB—The DTLB contains data page-translation entries and is fully associative. The page-translation entries stored in the DTLB represent the most-recently accessed data-page translations from the UTLB. The DTLB is used to minimize contention between data translation and UTLB-update operations. The initialization and management of the DTLB is controlled completely by hardware and is transparent to software.

Figure 2-19 provides the translation flow for TLB.

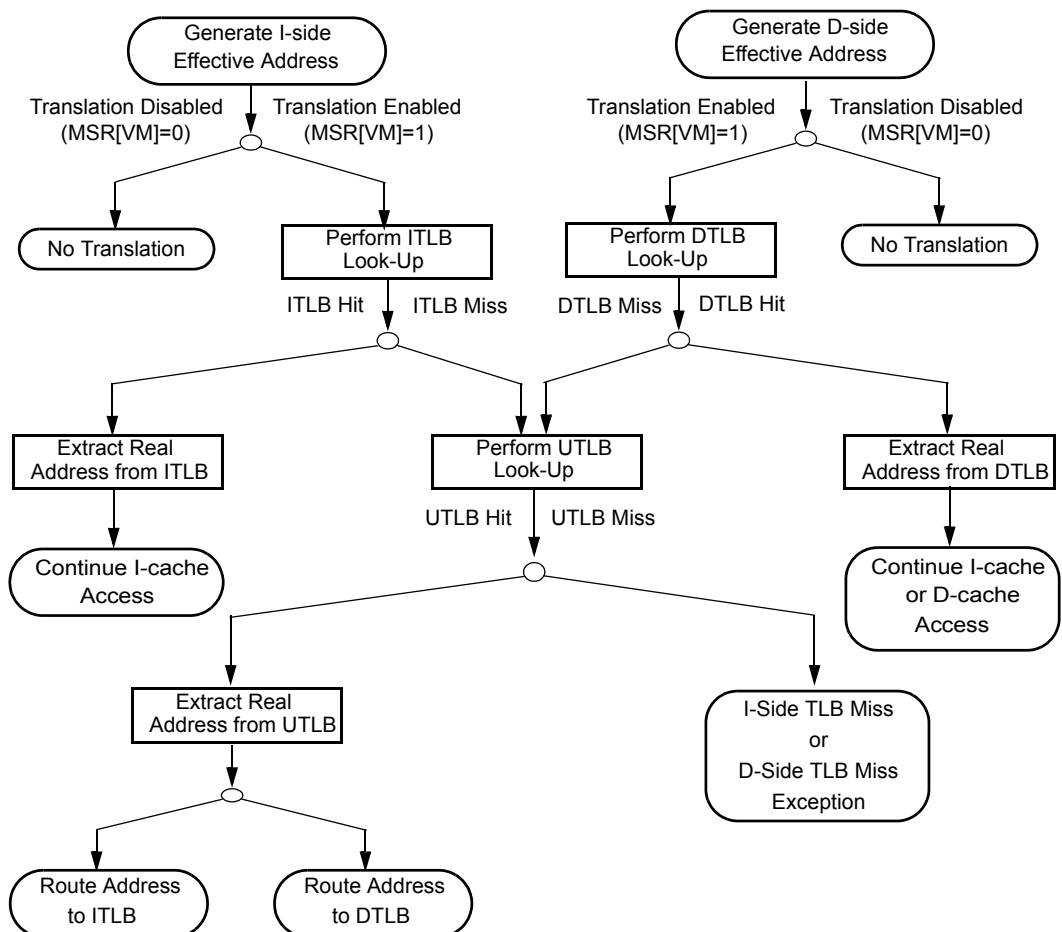

Figure 2-19: TLB Address Translation Flow

## TLB Entry Format

Figure 2-20 shows the format of a TLB entry. Each TLB entry is 68 bits and is composed of two portions: TLBLO (also referred to as the data entry), and TLBHI (also referred to as the tag entry).

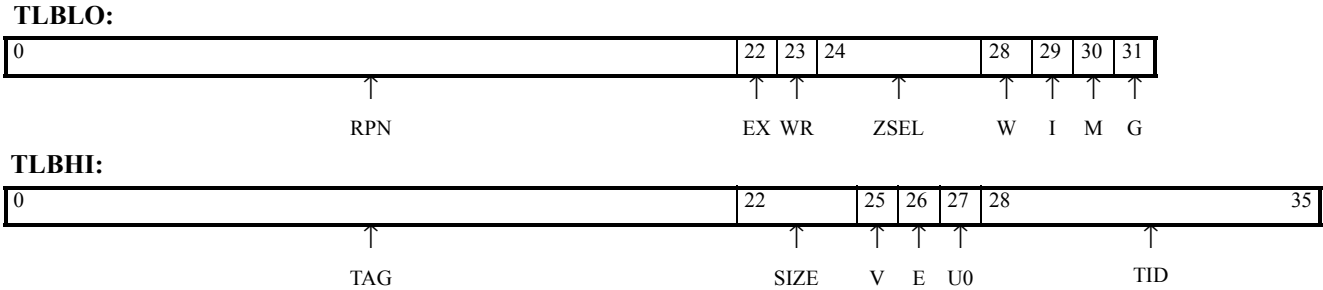

Figure 2-20: TLB Entry Format

The TLB entry contents are described in Table 2-20, page 38 and Table 2-21, page 40.

The fields within a TLB entry are categorized as follows:

- Virtual-page identification (TAG, SIZE, V, TID)—These fields identify the page-translation entry. They are compared with the virtual-page number during the translation process.
- Physical-page identification (RPN, SIZE)—These fields identify the translated page in physical memory.
- Access control (EX, WR, ZSEL)—These fields specify the type of access allowed in the page and are used to protect pages from improper accesses.
- Storage attributes (W, I, M, G, E, UO)—These fields specify the storage-control attributes, such as caching policy for the data cache (write-back or write-through), whether a page is cacheable, and how bytes are ordered (endianness).

Table 2-37 shows the relationship between the TLB-entry SIZE field and the translated page size. This table also shows how the page size determines which address bits are involved in a tag comparison, which address bits are used as a page offset, and which bits in the physical page number are used in the physical address.

Table 2-37: Page-Translation Bit Ranges by Page Size

Page Size	SIZE (TLBHI Field)	Tag Comparison Bit Range	Page Offset	Physical Page Number	RPN Bits Clear to 0
1 KB	000	TAG[0:21] - Address[0:21]	Address[22:31]	RPN[0:21]	-
4 KB	001	TAG[0:19] - Address[0:19]	Address[20:31]	RPN[0:19]	20:21
16 KB	010	TAG[0:17] - Address[0:17]	Address[18:31]	RPN[0:17]	18:21
64 KB	011	TAG[0:15] - Address[0:15]	Address[16:31]	RPN[0:15]	16:21
256 KB	100	TAG[0:13] - Address[0:13]	Address[14:31]	RPN[0:13]	14:21
1 MB	101	TAG[0:11] - Address[0:11]	Address[12:31]	RPN[0:11]	12:21
4 MB	110	TAG[0:9] - Address[0:9]	Address[10:31]	RPN[0:9]	10:21
16 MB	111	TAG[0:7] - Address[0:7]	Address[8:31]	RPN[0:7]	8:21

## TLB Access

When the MMU translates a virtual address (the combination of PID and effective address) into a physical address, it first examines the appropriate shadow TLB for the page translation entry. If an entry is found, it is used to access physical memory. If an entry is not found, the MMU examines the UTLB for the entry. A delay occurs each time the UTLB must be accessed due to a shadow TLB miss. The miss latency ranges from 2-32 cycles. The DTLB has priority over the ITLB if both simultaneously access the UTLB.

Figure 2-21, page 62 shows the logical process the MMU follows when examining a page-translation entry in one of the shadow TLBs or the UTLB. All valid entries in the TLB are checked.

A TLB hit occurs when all of the following conditions are met by a TLB entry:

- The entry is valid
- The TAG field in the entry matches the effective address EPN under the control of the SIZE field in the entry
- The TID field in the entry matches the PID

If any of the above conditions are not met, a TLB miss occurs. A TLB miss causes an exception, described as follows:

A TID value of 0x00 causes the MMU to ignore the comparison between the TID and PID. Only the TAG and EA[EPN] are compared. A TLB entry with TID=0x00 represents a process-independent translation. Pages that are accessed globally by all processes should be assigned a TID value of 0x00. A PID value of 0x00 does not identify a process that can access any page. When PID=0x00, a page-translation hit only occurs when TID=0x00. It is possible for software to load the TLB with multiple entries that match an EA[EPN] and PID combination. However, this is considered a programming error and results in undefined behavior.

When a hit occurs, the MMU reads the RPN field from the corresponding TLB entry. Some or all of the bits in this field are used, depending on the value of the SIZE field (see Table 2-37). For example, if the SIZE field specifies a 256 kB page size, RPN[0:13] represents the physical page number and is used to form the physical address. RPN[14:21] is not used, and software must clear those bits to 0 when initializing the TLB entry. The remainder of the physical address is taken from the page-offset portion of the EA. If the page size is 256 kB, the 32-bit physical address is formed by concatenating RPN[0:13] with bits 14:31 of the effective address.

Prior to accessing physical memory, the MMU examines the TLB-entry access-control fields. These fields indicate whether the currently executing program is allowed to perform the requested memory access.

If access is allowed, the MMU checks the storage-attribute fields to determine how to access the page. The storage-attribute fields specify the caching policy for memory accesses.

## TLB Access Failures

A TLB-access failure causes an exception to occur. This interrupts execution of the instruction that caused the failure and transfers control to an interrupt handler to resolve the failure. A TLB access can fail for two reasons:

- A matching TLB entry was not found, resulting in a TLB miss
- A matching TLB entry was found, but access to the page was prevented by either the storage attributes or zone protection

When an interrupt occurs, the processor enters real mode by clearing MSR[VM] to 0. In real mode, all address translation and memory-protection checks performed by the MMU are disabled. After

system software initializes the UTLB with page-translation entries, management of the MicroBlaze UTLB is usually performed using interrupt handlers running in real mode.

Figure 2-21 diagrams the general process for examining a TLB entry.

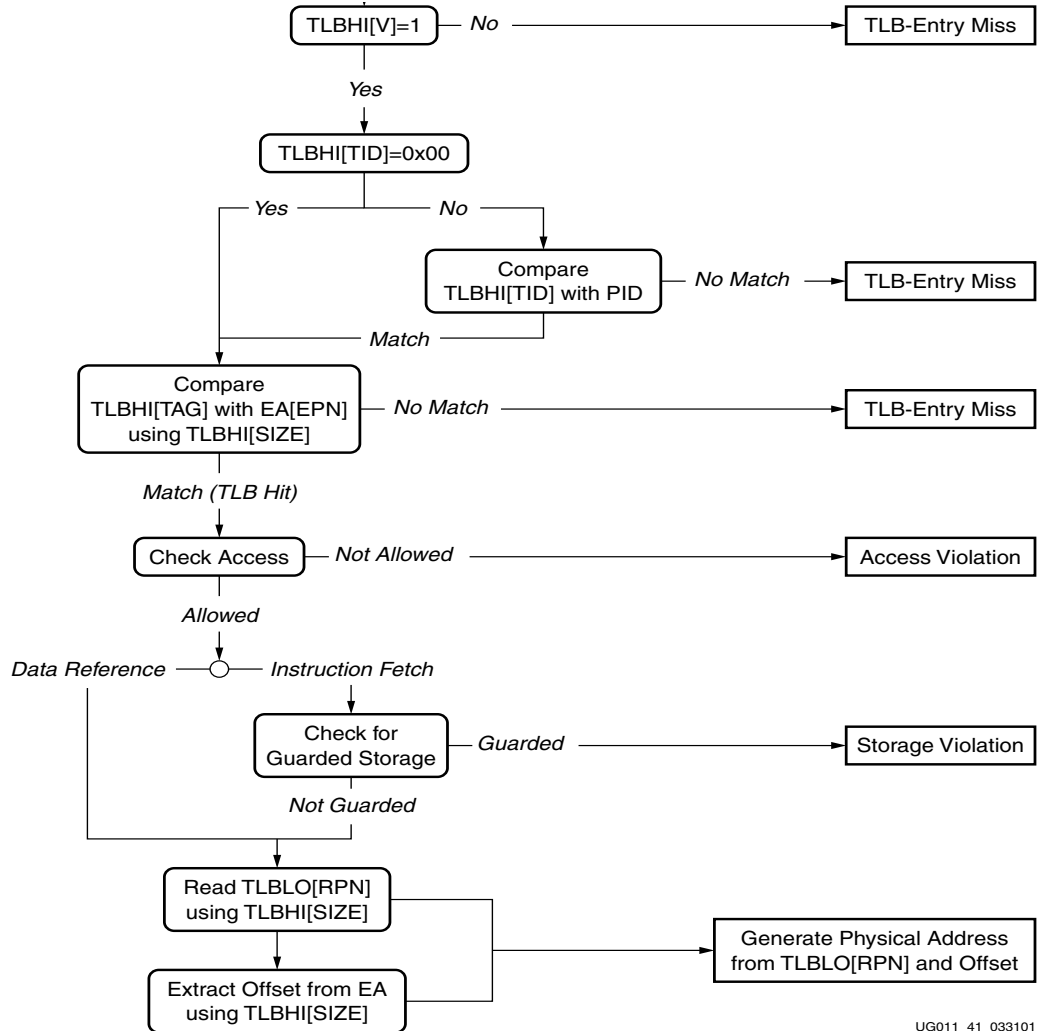

Figure 2-21: General Process for Examining a TLB Entry

The following sections describe the conditions under which exceptions occur due to TLB access failures.

### Data-Storage Exception

When virtual mode is enabled, (MSR[VM]=1), a data-storage exception occurs when access to a page is not permitted for any of the following reasons:

- From user mode:
  - ◆ The TLB entry specifies a zone field that prevents access to the page (ZPR[Zn]=00). This applies to load and store instructions.
  - ◆ The TLB entry specifies a read-only page (TLBLO[WR]=0) that is not otherwise overridden by the zone field (ZPR[Zn], 11). This applies to store instructions.

- From privileged mode:
  - ◆ The TLB entry specifies a read-only page (TLBLO[WR]=0) that is not otherwise overridden by the zone field (ZPR[Zn], 10 and ZPR[Zn], 11). This applies to store instructions.

### Instruction-Storage Exception

When virtual mode is enabled, (MSR[VM]=1), an instruction-storage exception occurs when access to a page is not permitted for any of the following reasons:

- From user mode:
  - ◆ The TLB entry specifies a zone field that prevents access to the page (ZPR[Zn]=00).
  - ◆ The TLB entry specifies a non-executable page (TLBLO[EX]=0) that is not otherwise overridden by the zone field (ZPR[Zn], 11).
  - ◆ The TLB entry specifies a guarded-storage page (TLBLO[G]=1).
- From privileged mode:
  - ◆ The TLB entry specifies a non-executable page (TLBLO[EX]=0) that is not otherwise overridden by the zone field (ZPR[Zn], 10 and ZPR[Zn], 11).
  - ◆ The TLB entry specifies a guarded-storage page (TLBLO[G]=1).

### Data TLB-Miss Exception

When virtual mode is enabled (MSR[VM]=1) a data TLB-miss exception occurs if a valid, matching TLB entry was not found in the TLB (shadow and UTLB). Any load or store instruction can cause a data TLB-miss exception.

### Instruction TLB-Miss Exception

When virtual mode is enabled (MSR[VM]=1) an instruction TLB-miss exception occurs if a valid, matching TLB entry was not found in the TLB (shadow and UTLB). Any instruction fetch can cause an instruction TLB-miss exception.

## Access Protection

System software uses access protection to protect sensitive memory locations from improper access. System software can restrict memory accesses for both user-mode and privileged-mode software. Restrictions can be placed on reads, writes, and instruction fetches. Access protection is available when virtual protected mode is enabled.

Access control applies to instruction fetches, data loads, and data stores. The TLB entry for a virtual page specifies the type of access allowed to the page. The TLB entry also specifies a zone-protection field in the zone-protection register that is used to override the access controls specified by the TLB entry.

### TLB Access-Protection Controls

Each TLB entry controls three types of access:

- Process—Processes are protected from unauthorized access by assigning a unique process ID (PID) to each process. When system software starts a user-mode application, it loads the PID for that application into the PID register. As the application executes, memory addresses are translated using only TLB entries with a TID field in Translation Look-Aside Buffer High (TLBHI) that matches the PID. This enables system software to restrict accesses for an application to a specific area in virtual memory.

A TLB entry with TID=0x00 represents a process-independent translation. Pages that are accessed globally by all processes should be assigned a TID value of 0x00.

- Execution—The processor executes instructions only if they are fetched from a virtual page marked as executable (TLBLO[EX]=1). Clearing TLBLO[EX] to 0 prevents execution of instructions fetched from a page, instead causing an instruction-storage interrupt (ISI) to occur. The ISI does not occur when the instruction is fetched, but instead occurs when the instruction is executed. This prevents speculatively fetched instructions that are later discarded (rather than executed) from causing an ISI.

The zone-protection register can override execution protection.

- Read/Write—Data is written only to virtual pages marked as writable (TLBLO[WR]=1). Clearing TLBLO[WR] to 0 marks a page as read-only. An attempt to write to a read-only page causes a data-storage interrupt (DSI) to occur.

The zone-protection register can override write protection.

TLB entries cannot be used to prevent programs from reading pages. In virtual mode, zone protection is used to read-protect pages. This is done by defining a no-access-allowed zone (ZPR[Zn] = 00) and using it to override the TLB-entry access protection. Only programs running in user mode can be prevented from reading a page. Privileged programs always have read access to a page.

## Zone Protection

Zone protection is used to override the access protection specified in a TLB entry. Zones are an arbitrary grouping of virtual pages with common access protection. Zones can contain any number of pages specifying any combination of page sizes. There is no requirement for a zone to contain adjacent pages.

The zone-protection register (ZPR) is a 32-bit register used to specify the type of protection override applied to each of 16 possible zones. The protection override for a zone is encoded in the ZPR as a 2-bit field. The 4-bit zone-select field in a TLB entry (TLBLO[ZSEL]) selects one of the 16 zone fields from the ZPR (Z0–Z15). For example, zone Z5 is selected when ZSEL = 0101.

Changing a zone field in the ZPR applies a protection override across all pages in that zone. Without the ZPR, protection changes require individual alterations to each page translation entry within the zone.

Unimplemented zones (when C\_MMU\_ZONES < 16) are treated as if they contained 11.

## UTLB Management

The UTLB serves as the interface between the processor MMU and memory-management software. System software manages the UTLB to tell the MMU how to translate virtual addresses into physical addresses. When a problem occurs due to a missing translation or an access violation, the MMU communicates the problem to system software using the exception mechanism. System software is responsible for providing interrupt handlers to correct these problems so that the MMU can proceed with memory translation.

Software reads and writes UTLB entries using the MFS and MTS instructions, respectively. These instructions use the TLBX register index (numbered 0 to 63) corresponding to one of the 64 entries in the UTLB. The tag and data portions are read and written separately, so software must execute two MFS or MTS instructions to completely access an entry. The UTLB is searched for a specific translation using the TLBSX register. TLBSX locates a translation using an effective address and loads the corresponding UTLB index into the TLBX register.

Individual UTLB entries are invalidated using the MTS instruction to clear the valid bit in the tag portion of a TLB entry (TLBHI[V]).

When `C_FAULT_TOLERANT` is set to 1, the UTLB block RAM is protected by parity. In case of a parity error, a TLB miss exception occurs. To avoid accumulating errors in this case, each entry in the UTLB should be periodically invalidated.

## Recording Page Access and Page Modification

Software management of virtual-memory poses several challenges:

- In a virtual-memory environment, software and data often consume more memory than is physically available. Some of the software and data pages must be stored outside physical memory, such as on a hard drive, when they are not used. Ideally, the most-frequently used pages stay in physical memory and infrequently used pages are stored elsewhere.
- When pages in physical-memory are replaced to make room for new pages, it is important to know whether the replaced (old) pages were modified. If they were modified, they must be saved prior to loading the replacement (new) pages. If the old pages were not modified, the new pages can be loaded without saving the old pages.
- A limited number of page translations are kept in the UTLB. The remaining translations must be stored in the page-translation table. When a translation is not found in the UTLB (due to a miss), system software must decide which UTLB entry to discard so that the missing translation can be loaded. It is desirable for system software to replace infrequently used translations rather than frequently used translations.

Solving the above problems in an efficient manner requires keeping track of page accesses and page modifications. MicroBlaze does not track page access and page modification in hardware. Instead, system software can use the TLB-miss exceptions and the data-storage exception to collect this information. As the information is collected, it can be stored in a data structure associated with the page-translation table.

Page-access information is used to determine which pages should be kept in physical memory and which are replaced when physical-memory space is required. System software can use the valid bit in the TLB entry (TLBHI[V]) to monitor page accesses. This requires page translations be initialized as not valid (TLBHI[V]=0) to indicate they have not been accessed. The first attempt to access a page causes a TLB-miss exception, either because the UTLB entry is marked not valid or because the page translation is not present in the UTLB. The TLB-miss handler updates the UTLB with a valid translation (TLBHI[V]=1). The set valid bit serves as a record that the page and its translation have been accessed. The TLB-miss handler can also record the information in a separate data structure associated with the page-translation entry.

Page-modification information is used to indicate whether an old page can be overwritten with a new page or the old page must first be stored to a hard disk. System software can use the write-protection bit in the TLB entry (TLBLO[WR]) to monitor page modification. This requires page translations be initialized as read-only (TLBLO[WR]=0) to indicate they have not been modified. The first attempt to write data into a page causes a data-storage exception, assuming the page has already been accessed and marked valid as described above. If software has permission to write into the page, the data-storage handler marks the page as writable (TLBLO[WR]=1) and returns. The set write-protection bit serves as a record that a page has been modified. The data-storage handler can also record this information in a separate data structure associated with the page-translation entry.

Tracking page modification is useful when virtual mode is first entered and when a new process is started.



# Reset, Interrupts, Exceptions, and Break

MicroBlaze supports reset, interrupt, user exception, break, and hardware exceptions. The following section describes the execution flow associated with each of these events.

The relative priority starting with the highest is:

1. Reset
2. Hardware Exception
3. Non-maskable Break
4. Break
5. Interrupt
6. User Vector (Exception)

Table 2-38 defines the memory address locations of the associated vectors and the hardware enforced register file locations for return addresses. Each vector allocates two addresses to allow full address range branching (requires an IMM followed by a BRAI instruction). Normally the vectors start at address 0x00000000, but the parameter C\_BASE\_VECTORS can be used to locate them anywhere in memory.

The address range 0x28 to 0x4F is reserved for future software support by Xilinx. Allocating these addresses for user applications is likely to conflict with future releases of EDK support software.

**Table 2-38: Vectors and Return Address Register File Location**

Event	Vector Address	Register File Return Address
Reset	C_BASE_VECTORS + 0x00000000 - C_BASE_VECTORS + 0x00000004	-
User Vector (Exception)	C_BASE_VECTORS + 0x00000008 - C_BASE_VECTORS + 0x0000000C	Rx
Interrupt <sup>1</sup>	C_BASE_VECTORS + 0x00000010 - C_BASE_VECTORS + 0x00000014	R14
Break: Non-maskable hardware	C_BASE_VECTORS + 0x00000018 - C_BASE_VECTORS + 0x0000001C	R16
Break: Hardware		
Break: Software		
Hardware Exception	C_BASE_VECTORS + 0x00000020 - C_BASE_VECTORS + 0x00000024	R17 or BTR
Reserved by Xilinx for future use	C_BASE_VECTORS + 0x00000028 - C_BASE_VECTORS + 0x0000004F	-

1. With low-latency interrupt mode, the vector address is supplied by the Interrupt Controller.

All of these events will clear the reservation bit, used together with the LWX and SWX instructions to implement mutual exclusion, such as semaphores and spinlocks.

## Reset

When a `Reset`, `MB_Reset` or `Debug_Rst`<sup>(1)</sup> occurs, MicroBlaze flushes the pipeline and starts fetching instructions from the reset vector (address 0x0). Both external reset signals are active high and should be asserted for a minimum of 16 cycles.

1. Reset input controlled by the XMD debugger via MDM.

## Equivalent Pseudocode

```

PC ← C_BASE_VECTORS + 0x00000000
MSR ← C_RESET_MSR (see "MicroBlaze Core Configurability" in Chapter 3)
EAR ← 0; ESR ← 0; FSR ← 0
PID ← 0; ZPR ← 0; TLBX ← 0
Reservation ← 0

```

## Hardware Exceptions

MicroBlaze can be configured to trap the following internal error conditions: illegal instruction, instruction and data bus error, and unaligned access. The divide exception can only be enabled if the processor is configured with a hardware divider (`C_USE_DIV=1`). When configured with a hardware floating point unit (`C_USE_FPU>0`), it can also trap the following floating point specific exceptions: underflow, overflow, float division-by-zero, invalid operation, and denormalized operand error.

When configured with a hardware Memory Management Unit, it can also trap the following memory management specific exceptions: Illegal Instruction Exception, Data Storage Exception, Instruction Storage Exception, Data TLB Miss Exception, and Instruction TLB Miss Exception.

A hardware exception causes MicroBlaze to flush the pipeline and branch to the hardware exception vector (address `C_BASE_VECTORS + 0x20`). The execution stage instruction in the exception cycle is not executed.

The exception also updates the general purpose register R17 in the following manner:

- For the MMU exceptions (Data Storage Exception, Instruction Storage Exception, Data TLB Miss Exception, Instruction TLB Miss Exception) the register R17 is loaded with the appropriate program counter value to re-execute the instruction causing the exception upon return. The value is adjusted to return to a preceding IMM instruction, if any. If the exception is caused by an instruction in a branch delay slot, the value is adjusted to return to the branch instruction, including adjustment for a preceding IMM instruction, if any.
- For all other exceptions the register R17 is loaded with the program counter value of the subsequent instruction, unless the exception is caused by an instruction in a branch delay slot. If the exception is caused by an instruction in a branch delay slot, the ESR[DS] bit is set. In this case the exception handler should resume execution from the branch target address stored in BTR.

The EE and EIP bits in MSR are automatically reverted when executing the RTED instruction.

The VM and UM bits in MSR are automatically reverted from VMS and UMS when executing the RTED, RTBD, and RTID instructions.

## Exception Priority

When two or more exceptions occur simultaneously, they are handled in the following order, from the highest priority to the lowest:

- Instruction Bus Exception
- Instruction TLB Miss Exception
- Instruction Storage Exception
- Illegal Opcode Exception
- Privileged Instruction Exception or Stack Protection Violation Exception
- Data TLB Miss Exception
- Data Storage Exception

- Unaligned Exception
- Data Bus Exception
- Divide Exception
- FPU Exception
- Stream Exception

## Exception Causes

- Stream Exception
 

The stream exception (FSL or AXI) is caused by executing a `get` or `getd` instruction with the ‘e’ bit set to ‘1’ when there is a control bit mismatch.
- Instruction Bus Exception
 

The instruction bus exception is caused by errors when reading data from memory.

  - ◆ The instruction peripheral AXI4 interface (M\_AXI\_IP) exception is caused by an error response on M\_AXI\_IP\_RRESP.
  - ◆ The instruction cache AXI4 interface (M\_AXI\_IC) is caused by an error response on M\_AXI\_IC\_RRESP. The exception can only occur when C\_ICACHE\_ALWAYS\_USED is set to 1 and the cache is turned off. In all other cases the response is ignored.
  - ◆ The instruction Processor Local Bus (PLB) exception is caused by an active error signal from the slave (IPLB\_MRdErr) or timeout signal from the arbiter (IPLB\_MTimeOut).
  - ◆ The instructions side local memory (ILMB) can only cause instruction bus exception when C\_FAULT\_TOLERANT is set to 1, and either an uncorrectable error occurs in the LMB memory, as indicated by the IUE signal, or C\_ECC\_USE\_CE\_EXCEPTION is set to 1 and a correctable error occurs in the LMB memory, as indicated by the ICE signal.
  - ◆ The CacheLink (IXCL) interfaces cannot cause instruction bus exceptions.
- Illegal Opcode Exception
 

The illegal opcode exception is caused by an instruction with an invalid major opcode (bits 0 through 5 of instruction). Bits 6 through 31 of the instruction are not checked. Optional processor instructions are detected as illegal if not enabled. If the optional feature C\_OPCODE\_0x0\_ILLEGAL is enabled, an illegal opcode exception is also caused if the instruction is equal to 0x00000000.
- Data Bus Exception
 

The data bus exception is caused by errors when reading data from memory or writing data to memory.

  - ◆ The data peripheral AXI4 interface (M\_AXI\_DP) exception is caused by an error response on M\_AXI\_DP\_RRESP or M\_AXI\_DP\_BRESP.
  - ◆ The data cache AXI4 interface (M\_AXI\_DC) exception is caused by:
    - An error response on M\_AXI\_DC\_RRESP or M\_AXI\_DC\_BRESP,
    - OKAY response on M\_AXI\_DC\_RRESP in case of an exclusive access using LWX.

The exception can only occur when C\_DCACHE\_ALWAYS\_USED is set to 1 and the cache is turned off, or when an exclusive access using LWX or SWX is performed. In all other cases the response is ignored.
  - ◆ The data Processor Local Bus exception is caused by an active error signal from the slave (DPLB\_MRdErr or DPLB\_MWrErr) or timeout signal from the arbiter (DPLB\_MTimeOut).

- ◆ The data side local memory (DLMB) can only cause instruction bus exception when `C_FAULT_TOLERANT` is set to 1, and either an uncorrectable error occurs in the LMB memory, as indicated by the `DUE` signal, or `C_ECC_USE_CE_EXCEPTION` is set to 1 and a correctable error occurs in the LMB memory, as indicated by the `DCE` signal. An error can occur for all read accesses, and for byte and halfword write accesses.
- ◆ The CacheLink (DXCL) interfaces cannot cause data bus exceptions.
- Unaligned Exception
 

The unaligned exception is caused by a word access where the address to the data bus has bits 30 or 31 set, or a half-word access with bit 31 set.
- Divide Exception
 

The divide exception is caused by an integer division (`idiv` or `idivu`) where the divisor is zero, or by a signed integer division (`idiv`) where overflow occurs (`-2147483648 / -1`).
- FPU Exception
 

An FPU exception is caused by an underflow, overflow, divide-by-zero, illegal operation, or denormalized operand occurring with a floating point instruction.

  - ◆ Underflow occurs when the result is denormalized.
  - ◆ Overflow occurs when the result is not-a-number (NaN).
  - ◆ The divide-by-zero FPU exception is caused by the `rA` operand to `fdiv` being zero when `rB` is not infinite.
  - ◆ Illegal operation is caused by a signaling NaN operand or by illegal infinite or zero operand combinations.
- Privileged Instruction Exception
 

The Privileged Instruction exception is caused by an attempt to execute a privileged instruction in User Mode.
- Stack Protection Violation Exception
 

A Stack Protection Violation exception is caused by executing a load or store instruction using the stack pointer (register `R1`) as `rA` with an address outside the stack boundaries defined by the special Stack Low and Stack High registers, causing a stack overflow or a stack underflow.
- Data Storage Exception
 

The Data Storage exception is caused by an attempt to access data in memory that results in a memory-protection violation.
- Instruction Storage Exception
 

The Instruction Storage exception is caused by an attempt to access instructions in memory that results in a memory-protection violation.
- Data TLB Miss Exception
 

The Data TLB Miss exception is caused by an attempt to access data in memory, when a valid Translation Look-Aside Buffer entry is not present, and virtual protected mode is enabled.
- Instruction TLB Miss Exception
 

The Instruction TLB Miss exception is caused by an attempt to access instructions in memory, when a valid Translation Look-Aside Buffer entry is not present, and virtual protected mode is enabled.

Should an Instruction Bus Exception, Illegal Opcode Exception or Data Bus Exception occur when `C_FAULT_TOLERANT` is set to 1, and an exception is in progress (i.e. `MSR[EIP]` set and `MSR[EE]` cleared), the pipeline is halted, and the external signal `MB_Error` is set.

## Equivalent Pseudocode

```

ESR[DS] ← exception in delay slot
if ESR[DS] then
  BTR ← branch target PC
  if MMU exception then
    if branch preceded by IMM then
      r17 ← PC - 8
    else
      r17 ← PC - 4
  else
    r17 ← invalid value
else if MMU exception then
  if instruction preceded by IMM then
    r17 ← PC - 4
  else
    r17 ← PC
else
  r17 ← PC + 4
PC ← C_BASE_VECTORS + 0x00000020
MSR[EE] ← 0, MSR[EIP] ← 1
MSR[UMS] ← MSR[UM], MSR[UM] ← 0, MSR[VMS] ← MSR[VM], MSR[VM] ← 0
ESR[EC] ← exception specific value
ESR[ESS] ← exception specific value
EAR ← exception specific value
FSR ← exception specific value
Reservation ← 0

```

## Breaks

There are two kinds of breaks:

- Hardware (external) breaks
- Software (internal) breaks

### Hardware Breaks

Hardware breaks are performed by asserting the external break signal (that is, the Ext\_BRK and Ext\_NM\_BRK input ports). On a break, the instruction in the execution stage completes while the instruction in the decode stage is replaced by a branch to the break vector (address C\_BASE\_VECTORS + 0x18). The break return address (the PC associated with the instruction in the decode stage at the time of the break) is automatically loaded into general purpose register R16. MicroBlaze also sets the Break In Progress (BIP) flag in the Machine Status Register (MSR).

A normal hardware break (that is, the Ext\_BRK input port) is only handled when MSR[BIP] and MSR[EIP] are set to 0 (that is, there is no break or exception in progress). The Break In Progress flag disables interrupts. A non-maskable break (that is, the Ext\_NM\_BRK input port) is always handled immediately.

The BIP bit in the MSR is automatically cleared when executing the RTBD instruction.

The Ext\_BRK signal must be kept asserted until the break has occurred, and deasserted before the RTBD instruction is executed. The Ext\_NM\_BRK signal must only be asserted one clock cycle.

## Software Breaks

To perform a software break, use the `brk` and `brki` instructions. Refer to [Chapter 5, MicroBlaze Instruction Set Architecture](#) for detailed information on software breaks.

As a special case, when `C_USE_DEBUG` is set, and “`brki rD, 0x18`” is executed, a software breakpoint is signaled to the Xilinx Microprocessor Debugger (XMD) tool, irrespective of the value of `C_BASE_VECTORS`.

## Latency

The time it takes MicroBlaze to enter a break service routine from the time the break occurs depends on the instruction currently in the execution stage and the latency to the memory storing the break vector.

## Equivalent Pseudocode

```

r16 ← PC
PC ← C_BASE_VECTORS + 0x00000018
MSR[BIP] ← 1
MSR[UMS] ← MSR[UM], MSR[UM] ← 0, MSR[VMS] ← MSR[VM], MSR[VM] ← 0
Reservation ← 0

```

## Interrupt

MicroBlaze supports one external interrupt source (connected to the `Interrupt` input port). The processor only reacts to interrupts if the Interrupt Enable (IE) bit in the Machine Status Register (MSR) is set to 1. On an interrupt, the instruction in the execution stage completes while the instruction in the decode stage is replaced by a branch to the interrupt vector. This is either address `C_BASE_VECTORS + 0x10`, or with low-latency interrupt mode, the address supplied by the Interrupt Controller.

The interrupt return address (the PC associated with the instruction in the decode stage at the time of the interrupt) is automatically loaded into general purpose register R14. In addition, the processor also disables future interrupts by clearing the IE bit in the MSR. The IE bit is automatically set again when executing the `RTID` instruction.

Interrupts are ignored by the processor if either of the break in progress (BIP) or exception in progress (EIP) bits in the MSR are set to 1.

By using the parameter `C_INTERRUPT_IS_EDGE`, the external interrupt can either be set to level-sensitive or edge-sensitive:

- When using level-sensitive interrupts, the `Interrupt` input must remain set until MicroBlaze has taken the interrupt, and jumped to the interrupt vector. Software must clear the interrupt before returning from the interrupt handler. If not, the interrupt is taken again, as soon as interrupts are enabled when returning from the interrupt handler.
- When using edge-sensitive interrupts, MicroBlaze detects and latches the `Interrupt` input edge, which means that the input only needs to be asserted one clock cycle. The interrupt input can remain asserted, but must be deasserted at least one clock cycle before a new interrupt can be detected. The latching of an edge sensitive interrupt is independent of the IE bit in MSR. Should an interrupt occur while the IE bit is 0, it will immediately be serviced when the IE bit is set to 1.

## Low-latency Interrupt Mode

A low-latency interrupt mode is available, which allows the Interrupt Controller to directly supply the interrupt vector for each individual interrupt (via the `Interrupt_Address` input port).

The address of each fast interrupt handler must be passed to the Interrupt Controller when initializing the interrupt system. When a particular interrupt occurs, this address is supplied by the Interrupt Controller, which allows MicroBlaze to directly jump to the handler code.

With this mode, MicroBlaze also directly sends the appropriate interrupt acknowledge to the Interrupt Controller (via the `Interrupt_Ack` output port), although it is still the responsibility of the Interrupt Service Routine to acknowledge level sensitive interrupts at the source.

To inform the Interrupt Controller of the interrupt handling events, `Interrupt_Ack` is set to:

- 01 - when MicroBlaze jumps to the interrupt handler code,
- 10 - when the RTID instruction is executed to return from interrupt,
- 11 - when `MSR[IE]` is changed from 0 to 1, which enables interrupts again.

The `Interrupt_Ack` output port is active during one clock cycle, and is then reset to 00.

This information allows the Interrupt Controller to acknowledge interrupts appropriately, both for level-sensitive and edge-triggered interrupt.

## Latency

The time it takes MicroBlaze to enter an Interrupt Service Routine (ISR) from the time an interrupt occurs, depends on the configuration of the processor and the latency of the memory controller storing the interrupt vectors. If MicroBlaze is configured to have a hardware divider, the largest latency happens when an interrupt occurs during the execution of a division instruction.

With low-latency interrupt mode, the time to enter the ISR is significantly reduced, since the interrupt vector for each individual interrupt is directly supplied by the Interrupt Controller. With compiler support for fast interrupts, there is no need for a common ISR at all. Instead, the ISR for each individual interrupt will be directly called, and the compiler takes care of saving and restoring registers used by the ISR.

## Equivalent Pseudocode

```

r14 ← PC
if C_USE_INTERRUPT = 2
    PC ← Interrupt_Address
    Interrupt_Ack ← 01
else
    PC ← C_BASE_VECTORS + 0x00000010
MSR[IE] ← 0
MSR[UMS] ← MSR[UM], MSR[UM] ← 0, MSR[VMS] ← MSR[VM], MSR[VM] ← 0
Reservation ← 0

```

## User Vector (Exception)

The user exception vector is located at address 0x8. A user exception is caused by inserting a 'BRALID Rx, 0x8' instruction in the software flow. Although Rx could be any general purpose register, Xilinx recommends using R15 for storing the user exception return address, and to use the RTSD instruction to return from the user exception handler.

## Pseudocode

```

rx ← PC
PC ← C_BASE_VECTORS + 0x00000008
MSR[UMS] ← MSR[UM], MSR[UM] ← 0, MSR[VMS] ← MSR[VM], MSR[VM] ← 0
Reservation ← 0

```

# Instruction Cache

## Overview

MicroBlaze can be used with an optional instruction cache for improved performance when executing code that resides outside the LMB address range.

The instruction cache has the following features:

- Direct mapped (1-way associative)
- User selectable cacheable memory address range
- Configurable cache and tag size
- Caching over AXI4 interface (M\_AXI\_IC) or CacheLink (XCL) interface
- Option to use 4 or 8 word cache-line
- Cache on and off controlled using a bit in the MSR
- Optional WIC instruction to invalidate instruction cache lines
- Optional stream buffers to improve performance by speculatively prefetching instructions
- Optional victim cache to improve performance by saving evicted cache lines
- Optional parity protection that invalidates cache lines if a Block RAM bit error is detected
- Optional data width selection to either use 32 bits, an entire cache line, or 512 bits

## General Instruction Cache Functionality

When the instruction cache is used, the memory address space is split into two segments: a cacheable segment and a non-cacheable segment. The cacheable segment is determined by two parameters: `C_ICACHE_BASEADDR` and `C_ICACHE_HIGHADDR`. All addresses within this range correspond to the cacheable address segment. All other addresses are non-cacheable.

The cacheable segment size must be  $2^N$ , where  $N$  is a positive integer. The range specified by `C_ICACHE_BASEADDR` and `C_ICACHE_HIGHADDR` must comprise a complete power-of-two range, such that  $\text{range} = 2^N$  and the  $N$  least significant bits of `C_ICACHE_BASEADDR` must be zero.

The cacheable instruction address consists of two parts: the cache address, and the tag address. The MicroBlaze instruction cache can be configured from 64 bytes to 64 kB. This corresponds to a cache address of between 6 and 16 bits. The tag address together with the cache address should match the full address of cacheable memory. When selecting cache sizes below 2 kB, distributed RAM is used to implement the Tag RAM and Instruction RAM. Distributed RAM is always used to implement the Tag RAM, when setting the parameter `C_ICACHE_FORCE_TAG_LUTRAM` to 1. This parameter is only available with cache sizes 8 kB or 16 kB and less, for 4 or 8 word cache-lines, respectively.

For example: in a MicroBlaze configured with `C_ICACHE_BASEADDR= 0x00300000`, `C_ICACHE_HIGHADDR=0x0030ffff`, `C_CACHE_BYTE_SIZE=4096`, `C_ICACHE_LINE_LEN=8`, and `C_ICACHE_FORCE_TAG_LUTRAM=0`; the cacheable memory of 64 kB uses 16 bits of byte address, and the 4 kB cache uses 12 bits of byte address, thus the required address tag width is:  $16-12=4$  bits. The total number of block RAM primitives required in this configuration is: 2 RAMB16 for storing the 1024 instruction words, and 1 RAMB16 for 128 cache line entries, each consisting of: 4 bits of tag, 8 word-valid bits, 1 line-valid bit. In total 3 RAMB16 primitives.

Figure 2-22, page 74 shows the organization of Instruction Cache.



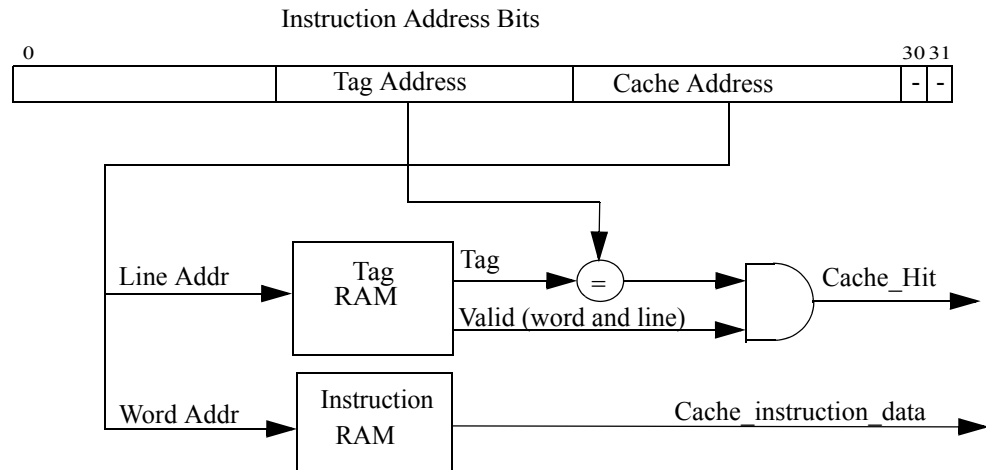

Figure 2-22: Instruction Cache Organization

## Instruction Cache Operation

For every instruction fetched, the instruction cache detects if the instruction address belongs to the cacheable segment. If the address is non-cacheable, the cache controller ignores the instruction and lets the M\_AXI\_IP, PLB or LMB complete the request. If the address is cacheable, a lookup is performed on the tag memory to check if the requested address is currently cached. The lookup is successful if: the word and line valid bits are set, and the tag address matches the instruction address tag segment. On a cache miss, the cache controller requests the new instruction over the instruction AXI4 interface (M\_AXI\_IC) or instruction CacheLink (IXCL) interface, and waits for the memory controller to return the associated cache line.

With the AXI4 interface, C\_ICACHE\_DATA\_WIDTH determines the bus data width, either 32 bits, an entire cache line (128 bits or 256 bits), or 512 bits.

When C\_FAULT\_TOLERANT is set to 1, a cache miss also occurs if a parity error is detected in a tag or instruction Block RAM.

The instruction cache always issues burst accesses for the CacheLink interface, whereas it only issues burst accesses for the AXI4 interface when 32-bit data width is used.

## Stream Buffers

When stream buffers are enabled, by setting the parameter C\_ICACHE\_STREAMS to 1, the cache will speculatively fetch cache lines in advance in sequence following the last requested address, until the stream buffer is full. The stream buffer can hold up to two cache lines. Should the processor subsequently request instructions from a cache line prefetched by the stream buffer, which occurs in linear code, they are immediately available.

The stream buffer often improves performance, since the processor generally has to spend less time waiting for instructions to be fetched from memory.

With the AXI4 interface, C\_ICACHE\_DATA\_WIDTH determines the amount of data transferred from the stream buffer each clock cycle, either 32 bits or an entire cache line.

To be able to use instruction cache stream buffers, area optimization must not be enabled.

## Victim Cache

The victim cache is enabled by setting the parameter `C_ICACHE_VICTIMS` to 2, 4 or 8. This defines the number of cache lines that can be stored in the victim cache. Whenever a cache line is evicted from the cache, it is saved in the victim cache. By saving the most recent lines they can be fetched much faster, should the processor request them, thereby improving performance. If the victim cache is not used, all evicted cache lines must be read from memory again when they are needed.

With the AXI4 interface, `C_ICACHE_DATA_WIDTH` determines the amount of data transferred from/to the victim cache each clock cycle, either 32 bits or an entire cache line.

Note that to be able to use the victim cache, area optimization must not be enabled.

## Instruction Cache Software Support

### MSR Bit

The ICE bit in the MSR provides software control to enable and disable caches.

The contents of the cache are preserved by default when the cache is disabled. You can invalidate cache lines using the WIC instruction or using the hardware debug logic of MicroBlaze.

### WIC Instruction

The optional WIC instruction (`C_ALLOW_ICACHE_WR=1`) is used to invalidate cache lines in the instruction cache from an application. For a detailed description, refer to [Chapter 5, MicroBlaze Instruction Set Architecture](#).

The WIC instruction can also be used together with parity protection to periodically invalidate entries the cache, to avoid accumulating errors.

## Data Cache

### Overview

MicroBlaze can be used with an optional data cache for improved performance. The cached memory range must not include addresses in the LMB address range. The data cache has the following features:

- Direct mapped (1-way associative)
- Write-through or Write-back
- User selectable cacheable memory address range
- Configurable cache size and tag size
- Caching over AXI4 interface (`M_AXI_DC`) or CacheLink (`XCL`) interface
- Option to use 4 or 8 word cache-lines
- Cache on and off controlled using a bit in the MSR
- Optional WDC instruction to invalidate or flush data cache lines
- Optional victim cache with write-back to improve performance by saving evicted cache lines
- Optional parity protection for write-through cache that invalidates cache lines if a Block RAM bit error is detected
- Optional data width selection to either use 32 bits, an entire cache line, or 512 bits



## Data Cache Operation

The caching policy used by the MicroBlaze data cache, write-back or write-through, is determined by the parameter `C_DCACHE_USE_WRITEBACK`. When this parameter is set, a write-back protocol is implemented, otherwise write-through is implemented. However, when configured with an MMU (`C_USE_MMU > 1`, `C_AREA_OPTIMIZED = 0`, `C_DCACHE_USE_WRITEBACK = 1`), the caching policy in virtual mode is determined by the W storage attribute in the TLB entry, whereas write-back is used in real mode.

With the write-back protocol, a store to an address within the cacheable range always updates the cached data. If the target address word is not in the cache (that is, the access is a cache miss), and the location in the cache contains data that has not yet been written to memory (the cache location is dirty), the old data is written over the data AXI4 interface (`M_AXI_DC`) or the data CacheLink (`DXCL`) to external memory before updating the cache with the new data. For the AXI4 interface, if only a single word needs to be written, a single word write is used otherwise a burst write is used. For the CacheLink interface, if an entire cache line needs to be written, a burst cache line write is used otherwise single word writes are used. For byte or halfword stores, in case of a cache miss, the address is first requested over the data AXI4 interface or the data CacheLink, while a word store only updates the cache.

With the write-through protocol, a store to an address within the cacheable range generates an equivalent byte, halfword, or word write over the data AXI4 interface or the data CacheLink to external memory. The write also updates the cached data if the target address word is in the cache (that is, the write is a cache hit). A write cache-miss does not load the associated cache line into the cache.

Provided that the cache is enabled a load from an address within the cacheable range triggers a check to determine if the requested data is currently cached. If it is (that is, on a cache hit) the requested data is retrieved from the cache. If not (that is, on a cache miss) the address is requested over the data AXI4 interface or data CacheLink using a burst read, and the processor pipeline stalls until the cache line associated to the requested address is returned from the external memory controller.

With the AXI4 interface, `C_DCACHE_DATA_WIDTH` determines the bus data width, either 32 bits, an entire cache line (128 bits or 256 bits), or 512 bits.

When `C_FAULT_TOLERANT` is set to 1 and write-through protocol is used, a cache miss also occurs if a parity error is detected in the tag or data Block RAM.

All types of accesses issued by the data cache AXI4 or CacheLink interface are summarized in [Table 2-39](#) and [Table 2-40](#).

**Table 2-39: AXI4 Data Cache Interface Accesses**

Policy	State	Direction	Access Type
Write-through	Cache Enabled	Read	Burst for 32-bit interface non-exclusive access and exclusive access with ACE enabled, single access otherwise
		Write	Single access
	Cache Disabled	Read	Burst for 32-bit interface exclusive access with ACE enabled, single access otherwise
		Write	Single access

Table 2-39: AXI4 Data Cache Interface Accesses (Continued)

Policy	State	Direction	Access Type
Write-back	Cache Enabled	Read	Burst for 32-bit interface, single access otherwise
		Write	Burst for 32-bit interface cache lines with more than one valid word, a single access otherwise
	Cache Disabled	Read	Burst for 32-bit interface non-exclusive access, discarding all but the desired data, a single access otherwise
		Write	Single access

Table 2-40: CacheLink Data Cache Interface Accesses

Policy	State	Direction	Access Type
Write-through	Cache Enabled	Read	Burst access
		Write	Single access
	Cache Disabled	Read	Burst access discarding all but the desire data
		Write	Single access
Write-back	Cache Enabled	Read	Burst access
		Write	Burst for complete valid cache lines, one or more single accesses otherwise
	Cache Disabled	Read	Burst for 32-bit interface discarding all but the desired data, single access otherwise
		Write	Single access

### Victim Cache

The victim cache is enabled by setting the parameter C\_DCACHE\_VICTIMS to 2, 4 or 8. This defines the number of cache lines that can be stored in the victim cache. Whenever a complete cache line is evicted from the cache, it is saved in the victim cache. By saving the most recent lines they can be fetched much faster, should the processor request them, thereby improving performance. If the victim cache is not used, all evicted cache lines must be read from memory again when they are needed.

With the AXI4 interface, C\_DCACHE\_DATA\_WIDTH determines the amount of data transferred from/to the victim cache each clock cycle, either 32 bits or an entire cache line.

Note that to be able to use the victim cache, write-back must be enabled and area optimization must not be enabled.

## Data Cache Software Support

### MSR Bit

The DCE bit in the MSR controls whether or not the cache is enabled. When disabling caches the user must ensure that all the prior writes within the cacheable range have been completed in external memory before reading back over M\_AXI\_DP or PLB. This can be done by writing to a semaphore immediately before turning off caches, and then in a loop poll until it has been written.

The contents of the cache are preserved when the cache is disabled.

## WDC Instruction

The optional WDC instruction (`C_ALLOW_DCACHE_WR=1`) is used to invalidate or flush cache lines in the data cache from an application. For a detailed description, please refer to [Chapter 5, MicroBlaze Instruction Set Architecture](#).

The WDC instruction can also be used together with parity protection to periodically invalidate entries the cache, to avoid accumulating errors.

# Floating Point Unit (FPU)

## Overview

The MicroBlaze floating point unit is based on the [IEEE 754-1985 standard](#):

- Uses IEEE 754 single precision floating point format, including definitions for infinity, not-a-number (NaN), and zero
- Supports addition, subtraction, multiplication, division, comparison, conversion and square root instructions
- Implements round-to-nearest mode
- Generates sticky status bits for: underflow, overflow, divide-by-zero and invalid operation

For improved performance, the following non-standard simplifications are made:

- Denormalized<sup>(1)</sup> operands are not supported. A hardware floating point operation on a denormalized number returns a quiet NaN and sets the sticky denormalized operand error bit in FSR; see "Floating Point Status Register (FSR)" on page 34
- A denormalized result is stored as a signed 0 with the underflow bit set in FSR. This method is commonly referred to as Flush-to-Zero (FTZ)
- An operation on a quiet NaN returns the fixed NaN: 0xFFC00000, rather than one of the NaN operands
- Overflow as a result of a floating point operation always returns signed  $\infty$

## Format

An IEEE 754 single precision floating point number is composed of the following three fields:

1. 1-bit *sign*
2. 8-bit biased *exponent*
3. 23-bit *fraction* (a.k.a. mantissa or significand)

The fields are stored in a 32 bit word as defined in [Figure 2-24](#):

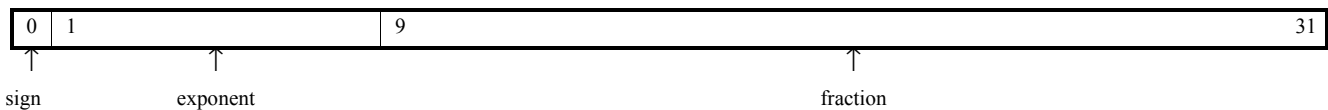

Figure 2-24: IEEE 754 Single Precision Format

The value of a floating point number  $v$  in MicroBlaze has the following interpretation:

1. If  $exponent = 255$  and  $fraction \neq 0$ , then  $v = NaN$ , regardless of the *sign* bit
2. If  $exponent = 255$  and  $fraction = 0$ , then  $v = (-1)^{sign} * \infty$
3. If  $0 < exponent < 255$ , then  $v = (-1)^{sign} * 2^{(exponent-127)} * (1.fraction)$
4. If  $exponent = 0$  and  $fraction \neq 0$ , then  $v = (-1)^{sign} * 2^{-126} * (0.fraction)$
5. If  $exponent = 0$  and  $fraction = 0$ , then  $v = (-1)^{sign} * 0$

1. Numbers that are so close to 0, that they cannot be represented with full precision, that is, any number  $n$  that falls in the following ranges:  $(1.17549 * 10^{-38} > n > 0)$ , or  $(0 > n > -1.17549 * 10^{-38})$

For practical purposes only 3 and 5 are useful, while the others all represent either an error or numbers that can no longer be represented with full precision in a 32 bit format.

## Rounding

The MicroBlaze FPU only implements the default rounding mode, “Round-to-nearest”, specified in IEEE 754. By definition, the result of any floating point operation should return the nearest single precision value to the infinitely precise result. If the two nearest representable values are equally near, then the one with its least significant bit zero is returned.

## Operations

All MicroBlaze FPU operations use the processors general purpose registers rather than a dedicated floating point register file, see “[General Purpose Registers](#)”.

### Arithmetic

The FPU implements the following floating point operations:

- addition, fadd
- subtraction, fsub
- multiplication, fmul
- division, fdiv
- square root, fsqrt (available if `C_USE_FPU = 2, EXTENDED`)

### Comparison

The FPU implements the following floating point comparisons:

- compare less-than, fcmp.lt
- compare equal, fcmp.eq
- compare less-or-equal, fcmp.le
- compare greater-than, fcmp.gt
- compare not-equal, fcmp.ne
- compare greater-or-equal, fcmp.ge
- compare unordered, fcmp.un (used for NaN)

### Conversion

The FPU implements the following conversions (available if `C_USE_FPU = 2, EXTENDED`):

- convert from signed integer to floating point, flt
- convert from floating point to signed integer, fint

## Exceptions

The floating point unit uses the regular hardware exception mechanism in MicroBlaze. When enabled, exceptions are thrown for all the IEEE standard conditions: underflow, overflow, divide-by-zero, and illegal operation, as well as for the MicroBlaze specific exception: denormalized operand error.

A floating point exception inhibits the write to the destination register (Rd). This allows a floating point exception handler to operate on the uncorrupted register file.



## Software Support

The EDK compiler system, based on GCC, provides support for the Floating Point Unit compliant with the MicroBlaze API. Compiler flags are automatically added to the GCC command line based on the type of FPU present in the system, when using XPS or SDK.

All double-precision operations are emulated in software. Be aware that the `xil_printf()` function does not support floating-point output. The standard C library `printf()` and related functions do support floating-point output, but will increase the program code size.

## Libraries and Binary Compatibility

The EDK compiler system only includes software floating point C runtime libraries. To take advantage of the hardware FPU, the libraries must be recompiled with the appropriate compiler switches.

For all cases where separate compilation is used, it is very important that you ensure the consistency of FPU compiler flags throughout the build.

## Operator Latencies

The latencies of the various operations supported by the FPU are listed in [Chapter 5, “MicroBlaze Instruction Set Architecture.”](#) The FPU instructions are not pipelined, so only one operation can be ongoing at any time.

## C Language Programming

To gain maximum benefit from the FPU without low-level assembly-language programming, it is important to consider how the C compiler will interpret your source code. Very often the same algorithm can be expressed in many different ways, and some are more efficient than others.

### Immediate Constants

Floating-point constants in C are double-precision by default. When using a single-precision FPU, careless coding may result in double-precision software emulation routines being used instead of the native single-precision instructions. To avoid this, explicitly specify (by cast or suffix) that immediate constants in your arithmetic expressions are single-precision values.

For example:

```
float x = 0.0;
...
x += (float)1.0; /* float addition */
x += 1.0F;      /* alternative to above */
x += 1.0;       /* warning - uses double addition! */
```

Note that the GNU C compiler can be instructed to treat all floating-point constants as single-precision (contrary to the ANSI C standard) by supplying the compiler flag `-fsingle-precision-constants`.

### Avoid unnecessary casting

While conversions between floating-point and integer formats are supported in hardware by the FPU, when `C_USE_FPU` is set to 2 (Extended), it is still best to avoid them when possible.

The following “bad” example calculates the sum of squares of the integers from 1 to 10 using floating-point representation:

```
float sum, t;
int i;
sum = 0.0f;
for (i = 1; i <= 10; i++) {
    t = (float)i;
    sum += t * t;
}
```

The above code requires a cast from an integer to a float on each loop iteration. This can be rewritten as:

```
float sum, t;
int i;
t = sum = 0.0f;
for(i = 1; i <= 10; i++) {
    t += 1.0f;
    sum += t * t;
}
```

Note that the compiler is not at liberty to perform this optimization in general, as the two code fragments above may give different results in some cases (for example, very large t).

### Square root runtime library function

The standard C runtime math library functions operate using double-precision arithmetic. When using a single-precision FPU, calls to the square root functions (`sqrt()`) result in inefficient emulation routines being used instead of FPU instructions:

```
#include <math.h>
...
float x=-1.0F;
...
x = sqrt(x); /* uses double precision */
```

Here the `math.h` header is included to avoid a warning message from the compiler.

When used with single-precision data types, the result is a cast to double, a runtime library call is made (which does not use the FPU) and then a truncation back to float is performed.

The solution is to use the non-ANSI function `sqrtf()` instead, which operates using single precision and can be carried out using the FPU. For example:

```
#include <math.h>
...
float x=-1.0F;
...
x = sqrtf(x); /* uses single precision */
```

Note that when compiling this code, the compiler flag `-fno-math-errno` (in addition to `-mhard-float` and `-mxl-float-sqrt`) must be used, to ensure that the compiler does not generate unnecessary code to handle error conditions by updating the `errno` variable.

## Stream Link Interfaces

MicroBlaze can be configured with up to 16 Fast Simplex Link (FSL) or AXI4-Stream interfaces, each consisting of one input and one output port. The channels are dedicated uni-directional point-to-point data streaming interfaces. The parameter `C_STREAM_INTERCONNECT` is used to select FSL or AXI4.

For detailed information on the FSL interface, please refer to the *Fast Simplex Link (FSL) Bus* data-sheet, DS449, in the Xilinx EDK IP Documentation. For detailed information on the AXI4-Stream interface, please refer to the *AMBA®4 AXI4-Stream Protocol Specification, Version 1.0* document.

The interfaces on MicroBlaze are 32 bits wide. A separate bit indicates whether the sent/received word is of control or data type. The get instruction in the MicroBlaze ISA is used to transfer information from a port to a general purpose register. The put instruction is used to transfer data in the opposite direction. Both instructions come in 4 flavors: blocking data, non-blocking data, blocking control, and non-blocking control. For a detailed description of the get and put instructions, please refer to [Chapter 5, MicroBlaze Instruction Set Architecture](#).

### Hardware Acceleration

Each link provides a low latency dedicated interface to the processor pipeline. Thus they are ideal for extending the processors execution unit with custom hardware accelerators. A simple example is illustrated in [Figure 2-25](#). The code uses `RFSLx` to indicate the used link, independent of whether FSL or AXI4-Stream is used.

*Example code:*

```
// Configure  $f_x$ 
cput Rc, RFSLx
// Store operands
put Ra, RFSLx // op 1
put Rb, RFSLx // op 2
// Load result
get Rt, RFSLx
```

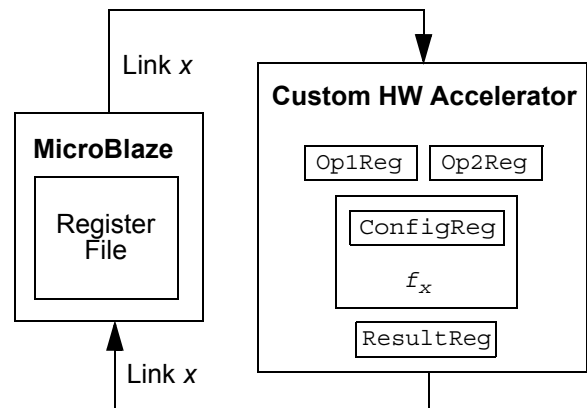

**Figure 2-25: Stream Link Used with HW Accelerated Function  $f_x$**

This method is similar to extending the ISA with custom instructions, but has the benefit of not making the overall speed of the processor pipeline dependent on the custom function. Also, there are no additional requirements on the software tool chain associated with this type of functional extension.

## Debug and Trace

### Debug Overview

MicroBlaze features a debug interface to support JTAG based software debugging tools (commonly known as BDM or Background Debug Mode debuggers) like the Xilinx Microprocessor Debug (XMD) tool. The debug interface is designed to be connected to the Xilinx Microprocessor Debug Module (MDM) core, which interfaces with the JTAG port of Xilinx FPGAs. Multiple MicroBlaze instances can be interfaced with a single MDM to enable multiprocessor debugging. The debugging features include:

- Configurable number of hardware breakpoints and watchpoints and unlimited software breakpoints
- External processor control enables debug tools to stop, reset, and single step MicroBlaze
- Read from and write to: memory, general purpose registers, and special purpose register, except EAR, EDR, ESR, BTR and PVR0 - PVR12, which can only be read
- Support for multiple processors

Whenever MicroBlaze is halted the `MB_Halted` output signal is set to 1, for example after a breakpoint or watchpoint is hit, after a stop XMD command, or when the `DBG_STOP` input is set. The output is cleared when MicroBlaze execution is resumed by an XMD command.

When the `DBG_STOP` input is set to 1, MicroBlaze will halt after a few instructions. XMD will detect that MicroBlaze has halted, and indicate where the halt occurred. The signal can be used to halt MicroBlaze at any external event, for example when a ChipScope™ logic analyzer is triggered.

The `MB_Halted` signal may be used to trigger a ChipScope logic analyzer, or halt other MicroBlaze cores in a multiprocessor system by connecting the signal to their `DBG_STOP` inputs.

### Trace Overview

The MicroBlaze trace interface exports a number of internal state signals for performance monitoring and analysis. Xilinx recommends that users only use the trace interface through Xilinx developed analysis cores. This interface is not guaranteed to be backward compatible in future releases of MicroBlaze.

## Fault Tolerance

The fault tolerance features included in MicroBlaze, enabled with `C_FAULT_TOLERANT`, provide Error Detection for internal block RAMs, and support for Error Detection and Correction (ECC) in LMB block RAMs. When fault tolerance is enabled, all soft errors in block RAMs are detected and corrected, which significantly reduces overall failure intensity.

In addition to protecting block RAM, the FPGA configuration memory also generally needs to be protected. A detailed explanation of this topic, and further references, can be found in the document [SEU Strategies for Virtex-5 Devices \(XAPP864\)](#).

## Configuration

### Using MicroBlaze Configuration

Fault tolerance can be enabled in the MicroBlaze configuration dialog, on the General page.

After enabling fault tolerance in MicroBlaze, ECC is automatically enabled in the connected LMB BRAM Interface Controllers by the tools, when the system is generated. This means that nothing else needs to be configured to enable fault tolerance and minimal ECC support.

It is possible (albeit not recommended) to manually override ECC support, leaving the LMB BRAM unprotected, by disabling `C_ECC` in the configuration dialogs of all connected LMB BRAM Interface Controllers. In this case, the internal MicroBlaze block RAM protection is still enabled, since fault tolerance is enabled.

### Using LMB BRAM Interface Controller Configuration

As an alternative to the method described above, it is also possible to enable ECC in the configuration dialogs of all connected LMB BRAM Interface Controllers. In this case, fault tolerance is automatically enabled in MicroBlaze by the tools, when the system is generated. This means that nothing else needs to be configured to enable ECC support and MicroBlaze fault tolerance.

ECC must either be enabled or disabled in all Controllers, which is enforced by a DRC.

It is possible to manually override fault tolerance support in MicroBlaze, by explicitly disabling `C_FAULT_TOLERANT` in the MicroBlaze configuration dialog. This is not recommended, unless no block RAM is used in MicroBlaze, and there is no need to handle bus exceptions from uncorrectable ECC errors.

## Features

An overview of all MicroBlaze fault tolerance features is given here. Further details on each feature can be found in the following sections:

- [“Instruction Cache Operation”](#)
- [“Data Cache Operation”](#)
- [“UTLB Management”](#)
- [“Branch Target Cache”](#)
- [“Instruction Bus Exception”](#)
- [“Data Bus Exception”](#)
- [“Exception Causes”](#)

The LMB BRAM Interface Controller v3.00.a or later provides the LMB ECC implementation. For details, including performance and resource utilization, see the *LogiCore IP LMB BRAM Interface Controller (PG061)* product guide, in the Xilinx EDK IP Documentation.

## Instruction and Data Cache Protection

To protect the block RAM in the Instruction and Data Cache, parity is used. When a parity error is detected, the corresponding cache line is invalidated. This forces the cache to reload the correct value from external memory. Parity is checked whenever a cache hit occurs.

Note that this scheme only works for write-through, and thus write-back data cache is not available when fault tolerance is enabled. This is enforced by a DRC.

When new values are written to a block RAM in the cache, parity is also calculated and written. One parity bit is used for the tag, one parity bit for the instruction cache data, and one parity bit for each word in a data cache line.

In many cases, enabling fault tolerance does not increase the required number of cache block RAMs, since spare bits can be used for the parity. Any increase in resource utilization, in particular number of block RAMs, can easily be seen in the MicroBlaze configuration dialog, when enabling fault tolerance.

## Memory Management Unit Protection

To protect the block RAM in the MMU Unified Translation Look-Aside Buffer (UTLB), parity is used. When a parity error is detected during an address translation, a TLB miss exception occurs, forcing software to reload the entry.

When a new TLB entry is written using the TLBHI and TLBLO registers, parity is calculated. One parity bit is used for each entry.

Parity is also checked when a UTLB entry is read using the TLBHI and TLBLO registers. When a parity error is detected in this case, the entry is marked invalid by clearing the valid bit.

Enabling fault tolerance does not increase the MMU block RAM size, since a spare bit is available for the parity.

## Branch Target Cache Protection

To protect block RAM in the Branch Target Cache, parity is used. When a parity error is detected when looking up a branch target address, the address is ignored, forcing a normal branch.

When a new branch address is written to the Branch Target Cache, parity is calculated. One parity bit is used for each address.

Enabling fault tolerance does not increase the Branch Target Cache block RAM size, since a spare bit is available for the parity.

## Exception Handling

With fault tolerance enabled, if an error occurs in LMB block RAM, the LMB BRAM Interface Controller generates error signals on the LMB interface.

If exceptions are enabled in MicroBlaze, by setting the EE bit in the Machine Status Register, the uncorrectable error signal either generates an instruction bus exception or a data bus exception, depending on the affected interface.

Should a bus exception occur when an exception is in progress, MicroBlaze is halted, and the external error signal MB\_Error is set. This behavior ensures that it is impossible to execute an instruction corrupted by an uncorrectable error.

## Software Support

### Scrubbing

To ensure that bit errors are not accumulated in block RAMs, they must be periodically scrubbed.

The standalone BSP provides the function `microblaze_scrub()` to perform scrubbing of the entire LMB block RAM and all MicroBlaze internal block RAMs used in a particular configuration. This function is intended to be called periodically from a timer interrupt routine.

The following example code illustrates how this can be done.

```
#include "xparameters.h"
#include "xtmrctr.h"
#include "xintc.h"
#include "mb_interface.h"

#define SCRUB_PERIOD ...

XIntc InterruptController; /* The Interrupt Controller instance */
XTmrCtr TimerCounterInst; /* The Timer Counter instance */

void MicroBlazeScrubHandler(void *CallbackRef, u8 TmrCtrNumber)
{
    /* Perform other timer interrupt processing here */
    microblaze_scrub();
}

int main (void)
{
    int Status;

    /*
     * Initialize the timer counter so that it's ready to use,
     * specify the device ID that is generated in xparameters.h
     */
    Status = XTmrCtr_Initialize(&TimerCounterInst, TMRCTR_DEVICE_ID);
    if (Status != XST_SUCCESS) {
        return XST_FAILURE;
    }

    /*
     * Connect the timer counter to the interrupt subsystem such that
     * interrupts can occur.
     */
    Status = XIntc_Initialize(&InterruptController, INTC_DEVICE_ID);
    if (Status != XST_SUCCESS) {
        return XST_FAILURE;
    }

    /*
     * Connect a device driver handler that will be called when an
     * interrupt for the device occurs, the device driver handler performs
     * the specific interrupt processing for the device
     */
    Status = XIntc_Connect(&InterruptController, TMRCTR_DEVICE_ID,
        (XInterruptHandler)XTmrCtr_InterruptHandler,
        (void *) &TimerCounterInst);
    if (Status != XST_SUCCESS) {
```

```

    return XST_FAILURE;
}

/*
 * Start the interrupt controller such that interrupts are enabled for
 * all devices that cause interrupts, specifying real mode so that the
 * timer counter can cause interrupts thru the interrupt controller.
 */
Status = XIntc_Start(&InterruptController, XIN_REAL_MODE);
if (Status != XST_SUCCESS) {
    return XST_FAILURE;
}

/*
 * Setup the handler for the timer counter that will be called from the
 * interrupt context when the timer expires, specify a pointer to the
 * timer counter driver instance as the callback reference so the
 * handler is able to access the instance data
 */
XTmrCtr_SetHandler(&TimerCounterInst, MicroBlazeScrubHandler,
                  &TimerCounterInst);

/*
 * Enable the interrupt of the timer counter so interrupts will occur
 * and use auto reload mode such that the timer counter will reload
 * itself automatically and continue repeatedly, without this option
 * it would expire once only
 */
XTmrCtr_SetOptions(&TimerCounterInst, TIMER_CNTR_0,
                  XTC_INT_MODE_OPTION | XTC_AUTO_RELOAD_OPTION);

/*
 * Set a reset value for the timer counter such that it will expire
 * earlier than letting it roll over from 0, the reset value is loaded
 * into the timer counter when it is started
 */
XTmrCtr_SetResetValue(TmrCtrInstancePtr, TmrCtrNumber, SCRUB_PERIOD);

/*
 * Start the timer counter such that it's incrementing by default,
 * then wait for it to timeout a number of times
 */
XTmrCtr_Start(&TimerCounterInst, TIMER_CNTR_0);

...
}

```

See the section “[Scrubbing](#)” below for further details on how scrubbing is implemented, including how to calculate the scrubbing rate.

## BRAM Driver

The standalone BSP BRAM driver is used to access the ECC registers in the LMB BRAM Interface Controller, and also provides a comprehensive self test.

By implementing the SDK Xilinx C Project "Peripheral Tests", a self-test example including the BRAM self test for each LMB BRAM Interface Controller in the system is generated. Depending on the ECC features enabled in the LMB BRAM Interface Controller, this code will perform all possible tests of the ECC function.



The self-test example can be found in the standalone BSP BRAM driver source code, typically in the subdirectory `microblaze_0/libsrc/bram_v3_00_a/src/xbram_selftest.c`.

## Scrubbing

### Scrubbing Methods

Scrubbing is performed using specific methods for the different block RAMs:

- Instruction and data caches: All lines in the caches are cyclically invalidated using the WIC and WDC instructions respectively. This forces the cache to reload the cache line from external memory.
- Memory Management Unit UTLB: All entries in the UTLB are cyclically invalidated by writing the TLBHI register with the valid bit cleared.
- Branch Target Cache: The entire BTC is invalidated by doing a synchronizing branch, BRI 4.
- LMB block RAM: All addresses in the memory are cyclically read and written, thus correcting any single bit errors on each address.

It is also possible to add interrupts for correctable errors from the LMB BRAM Interface Controllers, and immediately scrub this address in the interrupt handler, although in most cases it only improves reliability slightly.

The failing address can be determined by reading the Correctable Error First Failing Address Register in each of the LMB BRAM Interface Controllers. To be able to generate an interrupt `C_ECC_STATUS_REGISTERS` must be set to 1 in the connected LMB BRAM Interface Controllers, and to read the failing address `C_CE_FAILING_REGISTERS` must be set to 1.

### Calculating Scrubbing Rate

The scrubbing rate depends on failure intensity and desired reliability.

The approximate equation to determine the LMB memory scrubbing rate is in our case given by

$$P_W \approx 760 \left( \frac{BER^2}{SR^2} \right)$$

where  $P_W$  is the probability of an uncorrectable error in a memory word,  $BER$  is the soft error rate for a single memory bit, and  $SR$  is the Scrubbing Rate.

The soft error rates affecting block RAM for each product family can be found in [Device Reliability Report \(UG116\)](#).

## Use Cases

Several common use cases are described here. These use cases are derived from the [LogiCore IP Processor LMB BRAM Interface Controller \(PG061\)](#) product guide.

### Minimal

This system is obtained when enabling fault tolerance in MicroBlaze, without doing any other configuration.

The system is suitable when area constraints are high, and there is no need for testing of the ECC function, or analysis of error frequency and location. No ECC registers are implemented. Single bit errors are corrected by the ECC logic before being passed to MicroBlaze. Uncorrectable errors set an error signal, which generates an exception in MicroBlaze.

## Small

This system should be used when it is necessary to monitor error frequency, but there is no need for testing of the ECC function. It is a minimal system with Correctable Error Counter Register added to monitor single bit error rates. If the error rate is too high, the scrubbing rate should be increased to minimize the risk of a single bit error becoming an uncorrectable double bit error. Parameters set are `C_ECC = 1` and `C_CE_COUNTER_WIDTH = 10`.

## Typical

This system represents a typical use case, where it is required to monitor error frequency, as well as generating an interrupt to immediately correct a single bit error through software. It does not provide support for testing of the ECC function. It is a small system with Correctable Error First Failing registers and Status register added. A single bit error will latch the address for the access into the Correctable Error First Failing Address Register and set the `CE_STATUS` bit in the ECC Status Register. An interrupt will be generated triggering MicroBlaze to read the failing address and then perform a read followed by a write on the failing address. This will remove the single bit error from the BRAM, thus reducing the risk of the single bit error becoming a uncorrectable double bit error. Parameters set are `C_ECC = 1`, `C_CE_COUNTER_WIDTH = 10`, `C_ECC_STATUS_REGISTER = 1` and `C_CE_FAILING_REGISTERS = 1`.

## Full

This system uses all of the features provided by the LMB BRAM Interface Controller, to enable full error injection capability, as well as error monitoring and interrupt generation. It is a typical system with Uncorrectable Error First Failing registers and Fault Injection registers added. All features are switched on for full control of ECC functionality for system debug or systems with high fault tolerance requirements. Parameters set are `C_ECC = 1`, `C_CE_COUNTER_WIDTH = 10`, `C_ECC_STATUS_REGISTER = 1` and `C_CE_FAILING_REGISTERS = 1`, `C_UE_FAILING_REGISTERS = 1` and `C_FAULT_INJECT = 1`.

## Lockstep Operation

MicroBlaze is able to operate in a lockstep configuration, where two or more identical MicroBlaze cores execute the same program. By comparing the outputs of the cores, any tampering attempts, transient faults or permanent hardware faults can be detected.

### System Configuration

The parameter `C_LOCKSTEP_SLAVE` is set to one on all slave MicroBlaze cores in the system, except the master (or primary) core. The master core drives all the output signals, and handles the debug functionality. The port `Lockstep_Master_Out` on the master is connected to the port `Lockstep_Slave_In` on the slaves, in order to handle debugging.

The slave cores should not drive any output signals, only receive input signals. This must be ensured by only connecting signals to the input ports of the slaves. For buses this means that each individual input port must be explicitly connected.

The port `Lockstep_Out` on the master and slave cores provide all output signals for comparison. Unless an error occurs, individual signals from each of the cores are identical every clock cycle.

To ensure that lockstep operation works properly, all input signals to the cores must be synchronous. Input signals that may require external synchronization are `Interrupt`, `Reset`, `Mb_Reset`, `Ext_Brk`, and `Ext_Nm_Brk`.

### Use Cases

Two common use cases are described here. In addition, lockstep operation provides the basis for implementing triple modular redundancy on MicroBlaze core level.

### Tamper Protection

This application represents a high assurance use case, where it is required that the system is tamper-proof. A typically example is a cryptographic application.

The approach involves having two redundant MicroBlaze processors with dedicated local memory and redundant comparators, each in a protected area. The outputs from each processor feed two comparators and each processor receive copies of every input signal.

The redundant MicroBlaze processors are functionally identical and completely independent of each other, without any connecting signals. The only exception is debug logic and associated signals, since it is assumed that debugging is disabled before any productization and certification of the system.

The outputs from the master MicroBlaze core drive the peripherals in the system. All data leaving the protected area pass through inhibitors. Each inhibitor is controlled from its associated comparator.

Each protected area of the design must be implemented in its own partition, using a hierarchical Single Chip Cryptography (SCC) flow. A detailed explanation of this flow, and further references, can be found in the document [Hierarchical Design Methodology Guide \(UG748\)](#).

For Spartan-6 target architectures, the parameter `C_AVOID_PRIMITIVES` must be set to 3 (BOTH) in order to follow the SCC flow.

A block diagram of the system is shown in [Figure 2-26](#).

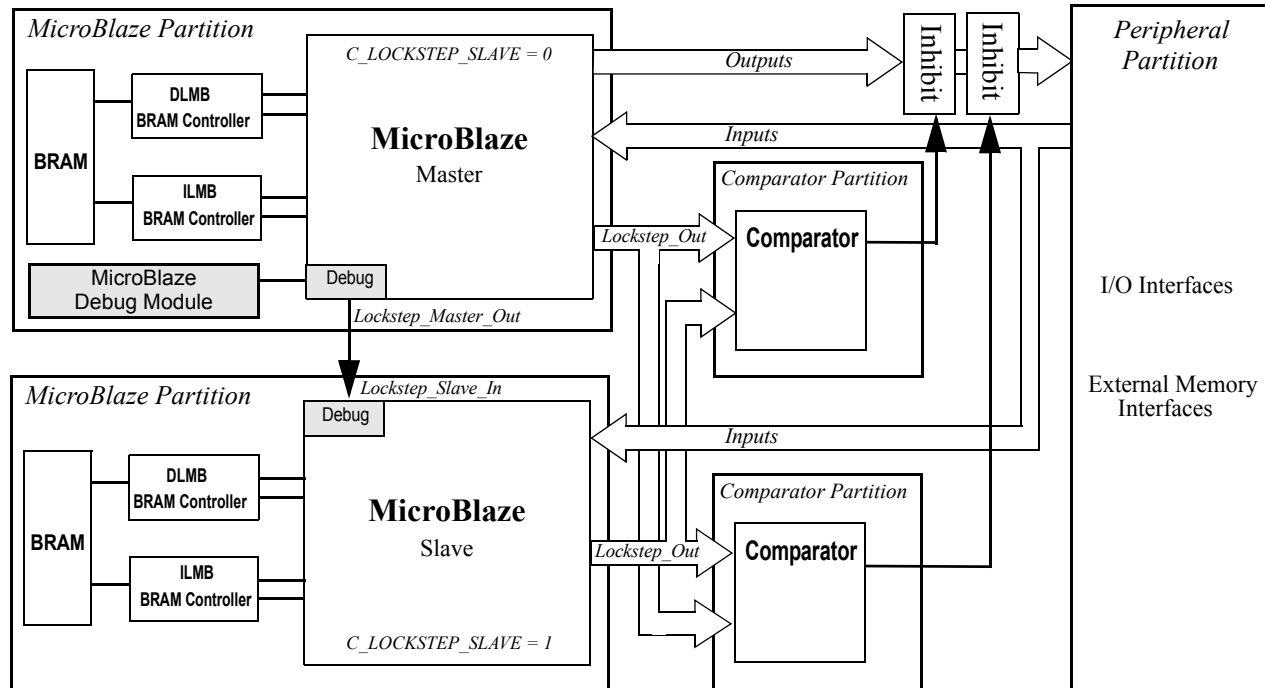

■ Debug Interface - Removed for Production

Figure 2-26: Lockstep Tamper Protection Application

## Error Detection

The error detection use case requires that all transient and permanent faults are detected. This is essential in fail safe and fault tolerant applications, where redundancy is utilized to improve system availability.

In this system two redundant MicroBlaze processors run in lockstep. A comparator is used to signal an error when a mis-match is detected on the outputs of the two processors. Any error immediately causes both processors to halt, preventing further error propagation.

The redundant MicroBlaze processors are functionally identical, except for debug logic and associated signals. The outputs from the master MicroBlaze core drive the peripherals in the system. The slave MicroBlaze core only has inputs connected; all outputs are left open.

The system contains the basic building block for designing a complete fault tolerant application, where one or more additional blocks must be added to provide redundancy.

This use case is illustrated in [Figure 2-27](#).

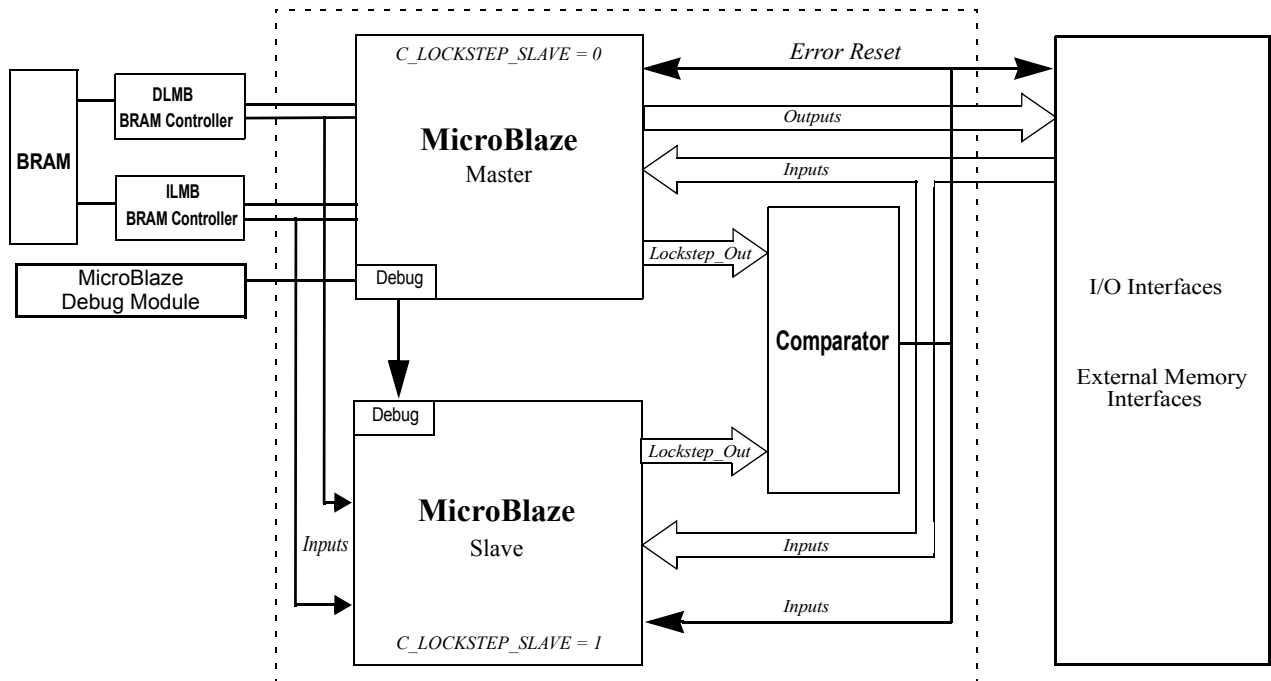

Figure 2-27: Lockstep Error Detection Application



# MicroBlaze Signal Interface Description

---

This chapter describes the types of signal interfaces that can be used to connect MicroBlaze™.

## Overview

The MicroBlaze core is organized as a Harvard architecture with separate bus interface units for data and instruction accesses. The following four memory interfaces are supported: Local Memory Bus (LMB), the AMBA® AXI4 interface (AXI4) and ACE interface (ACE), the IBM Processor Local Bus (PLB), and Xilinx CacheLink (XCL). The LMB provides single-cycle access to on-chip dual-port block RAM. The AXI4 and PLB interfaces provide a connection to both on-chip and off-chip peripherals and memory. The ACE interfaces provide cache coherent connections to memory. The CacheLink interface is intended for use with specialized external memory controllers. MicroBlaze also supports up to 16 Fast Simplex Link (FSL) or AXI4-Stream interface ports, each with one master and one slave interface.

## Features

MicroBlaze can be configured with the following bus interfaces:

- The AMBA AXI4 Interface for peripheral interfaces, and the AMBA AXI4 or ACE Interface for cache interfaces (see ARM® *AMBA® AXI and ACE Protocol Specification, ARM IHI 0022E*).
- A 32-bit version of the PLB V4.6 interface (see IBM's *128-Bit Processor Local Bus Architectural Specifications, Version 4.6*).
- LMB provides simple synchronous protocol for efficient block RAM transfers
- FSL or AXI4-Stream provides a fast non-arbitrated streaming communication mechanism
- XCL provides a fast slave-side arbitrated streaming interface between caches and external memory controllers
- Debug interface for use with the Microprocessor Debug Module (MDM) core
- Trace interface for performance analysis

## MicroBlaze I/O Overview

The core interfaces shown in Figure 3-1 and the following Table 3-1 are defined as follows:

- M\_AXI\_DP:** Peripheral Data Interface, AXI4-Lite or AXI4 interface
- DPLB:** Data interface, Processor Local Bus
- DLMB:** Data interface, Local Memory Bus (BRAM only)
- M\_AXI\_IP:** Peripheral Instruction interface, AXI4-Lite interface
- IPLB:** Instruction interface, Processor Local Bus
- ILMB:** Instruction interface, Local Memory Bus (BRAM only)
- M0\_AXIS..M15\_AXIS:** AXI4-Stream interface master direct connection interfaces
- S0\_AXIS..S15\_AXIS:** AXI4-Stream interface slave direct connection interfaces
- MFSL 0..15:** FSL master interfaces
- DWFSL 0..15:** FSL master direct connection interfaces
- SFSL 0..15:** FSL slave interfaces
- DRFSL 0..15:** FSL slave direct connection interfaces
- DXCL:** Data side Xilinx CacheLink interface (FSL master/slave pair)
- M\_AXI\_DC:** Data side cache AXI4 interface
- M\_ACE\_DC:** Data side cache ACE interface
- IXCL:** Instruction side Xilinx CacheLink interface (FSL master/slave pair)
- M\_AXI\_IC:** Instruction side cache AXI4 interface
- M\_ACE\_IC:** Instruction side cache ACE interface
- Core:** Miscellaneous signals for: clock, reset, debug, and trace

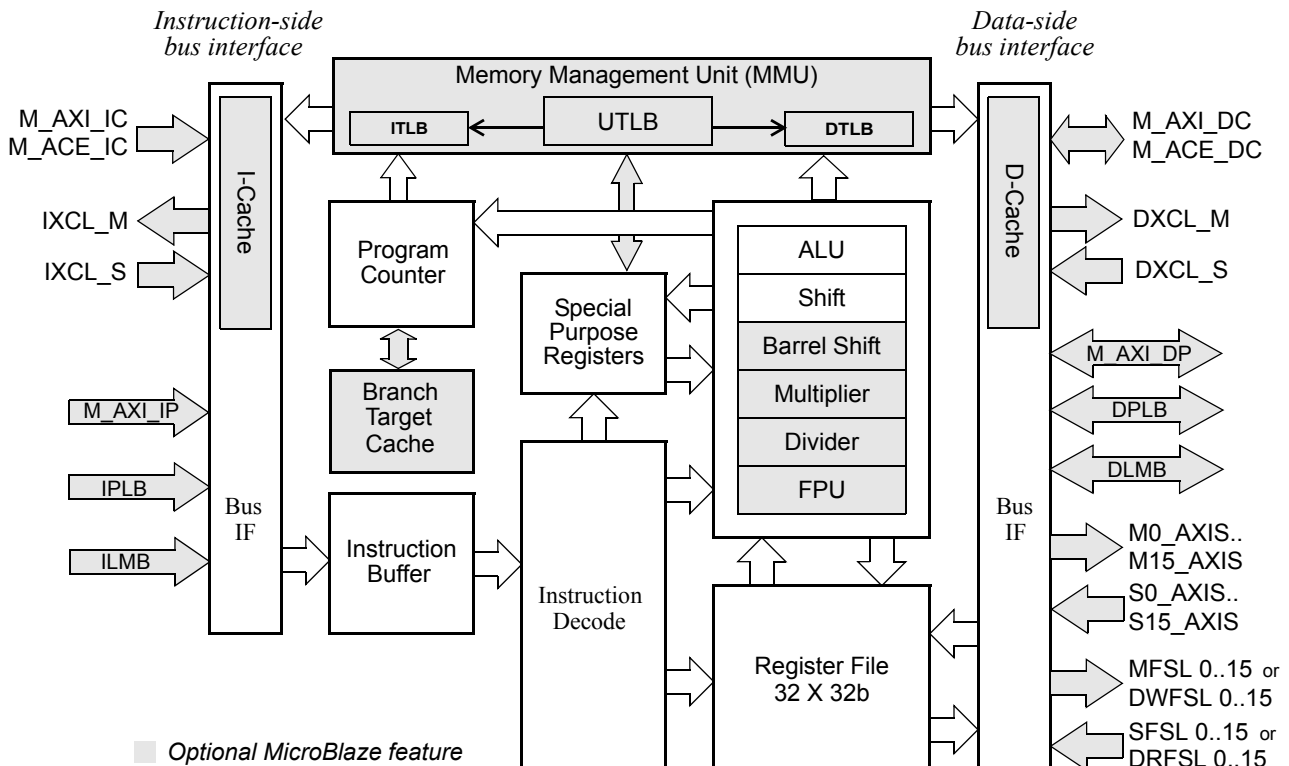

Figure 3-1: MicroBlaze Core Block Diagram



**Table 3-1: Summary of MicroBlaze Core I/O**

Signal	Interface	I/O	Description
M_AXI_DP_AWID	M_AXI_DP	O	Master Write address ID
M_AXI_DP_AWADDR	M_AXI_DP	O	Master Write address
M_AXI_DP_AWLEN	M_AXI_DP	O	Master Burst length
M_AXI_DP_AWSIZE	M_AXI_DP	O	Master Burst size
M_AXI_DP_AWBURST	M_AXI_DP	O	Master Burst type
M_AXI_DP_AWLOCK	M_AXI_DP	O	Master Lock type
M_AXI_DP_AWCACHE	M_AXI_DP	O	Master Cache type
M_AXI_DP_AWPROT	M_AXI_DP	O	Master Protection type
M_AXI_DP_AWQOS	M_AXI_DP	O	Master Quality of Service
M_AXI_DP_AWVALID	M_AXI_DP	O	Master Write address valid
M_AXI_DP_AWREADY	M_AXI_DP	I	Slave Write address ready
M_AXI_DP_WDATA	M_AXI_DP	O	Master Write data
M_AXI_DP_WSTRB	M_AXI_DP	O	Master Write strobes
M_AXI_DP_WLAST	M_AXI_DP	O	Master Write last
M_AXI_DP_WVALID	M_AXI_DP	O	Master Write valid
M_AXI_DP_WREADY	M_AXI_DP	I	Slave Write ready
M_AXI_DP_BID	M_AXI_DP	I	Slave Response ID
M_AXI_DP_BRESP	M_AXI_DP	I	Slave Write response
M_AXI_DP_BVALID	M_AXI_DP	I	Slave Write response valid
M_AXI_DP_BREADY	M_AXI_DP	O	Master Response ready
M_AXI_DP_ARID	M_AXI_DP	O	Master Read address ID
M_AXI_DP_ARADDR	M_AXI_DP	O	Master Read address
M_AXI_DP_ARLEN	M_AXI_DP	O	Master Burst length
M_AXI_DP_ARSIZE	M_AXI_DP	O	Master Burst size
M_AXI_DP_ARBURST	M_AXI_DP	O	Master Burst type
M_AXI_DP_ARLOCK	M_AXI_DP	O	Master Lock type
M_AXI_DP_ARCACHE	M_AXI_DP	O	Master Cache type
M_AXI_DP_ARPROT	M_AXI_DP	O	Master Protection type
M_AXI_DP_ARQOS	M_AXI_DP	O	Master Quality of Service
M_AXI_DP_ARVALID	M_AXI_DP	O	Master Read address valid
M_AXI_DP_ARREADY	M_AXI_DP	I	Slave Read address ready

Table 3-1: Summary of MicroBlaze Core I/O (Continued)

Signal	Interface	I/O	Description
M_AXI_DP_RID	M_AXI_DP	I	Slave Read ID tag
M_AXI_DP_RDATA	M_AXI_DP	I	Slave Read data
M_AXI_DP_RRESP	M_AXI_DP	I	Slave Read response
M_AXI_DP_RLAST	M_AXI_DP	I	Slave Read last
M_AXI_DP_RVALID	M_AXI_DP	I	Slave Read valid
M_AXI_DP_RREADY	M_AXI_DP	O	Master Read ready
M_AXI_IP_AWID	M_AXI_IP	O	Master Write address ID
M_AXI_IP_AWADDR	M_AXI_IP	O	Master Write address
M_AXI_IP_AWLEN	M_AXI_IP	O	Master Burst length
M_AXI_IP_AWSIZE	M_AXI_IP	O	Master Burst size
M_AXI_IP_AWBURST	M_AXI_IP	O	Master Burst type
M_AXI_IP_AWLOCK	M_AXI_IP	O	Master Lock type
M_AXI_IP_AWCACHE	M_AXI_IP	O	Master Cache type
M_AXI_IP_AWPROT	M_AXI_IP	O	Master Protection type
M_AXI_IP_AWQOS	M_AXI_IP	O	Master Quality of Service
M_AXI_IP_AWVALID	M_AXI_IP	O	Master Write address valid
M_AXI_IP_AWREADY	M_AXI_IP	I	Slave Write address ready
M_AXI_IP_WDATA	M_AXI_IP	O	Master Write data
M_AXI_IP_WSTRB	M_AXI_IP	O	Master Write strobes
M_AXI_IP_WLAST	M_AXI_IP	O	Master Write last
M_AXI_IP_WVALID	M_AXI_IP	O	Master Write valid
M_AXI_IP_WREADY	M_AXI_IP	I	Slave Write ready
M_AXI_IP_BID	M_AXI_IP	I	Slave Response ID
M_AXI_IP_BRESP	M_AXI_IP	I	Slave Write response
M_AXI_IP_BVALID	M_AXI_IP	I	Slave Write response valid
M_AXI_IP_BREADY	M_AXI_IP	O	Master Response ready
M_AXI_IP_ARID	M_AXI_IP	O	Master Read address ID
M_AXI_IP_ARADDR	M_AXI_IP	O	Master Read address
M_AXI_IP_ARLEN	M_AXI_IP	O	Master Burst length
M_AXI_IP_ARSIZE	M_AXI_IP	O	Master Burst size
M_AXI_IP_ARBURST	M_AXI_IP	O	Master Burst type
M_AXI_IP_ARLOCK	M_AXI_IP	O	Master Lock type

**Table 3-1: Summary of MicroBlaze Core I/O (Continued)**

Signal	Interface	I/O	Description
M_AXI_IP_ARCACHE	M_AXI_IP	O	Master Cache type
M_AXI_IP_ARPROT	M_AXI_IP	O	Master Protection type
M_AXI_IP_ARQOS	M_AXI_IP	O	Master Quality of Service
M_AXI_IP_ARVALID	M_AXI_IP	O	Master Read address valid
M_AXI_IP_ARREADY	M_AXI_IP	I	Slave Read address ready
M_AXI_IP_RID	M_AXI_IP	I	Slave Read ID tag
M_AXI_IP_RDATA	M_AXI_IP	I	Slave Read data
M_AXI_IP_RRESP	M_AXI_IP	I	Slave Read response
M_AXI_IP_RLAST	M_AXI_IP	I	Slave Read last
M_AXI_IP_RVALID	M_AXI_IP	I	Slave Read valid
M_AXI_IP_RREADY	M_AXI_IP	O	Master Read ready
M_AXI_DC_AWADDR	M_AXI_DC	O	Master Write address
M_AXI_DC_AWLEN	M_AXI_DC	O	Master Burst length
M_AXI_DC_AWSIZE	M_AXI_DC	O	Master Burst size
M_AXI_DC_AWBURST	M_AXI_DC	O	Master Burst type
M_AXI_DC_AWLOCK	M_AXI_DC	O	Master Lock type
M_AXI_DC_AWCACHE	M_AXI_DC	O	Master Cache type
M_AXI_DC_AWPROT	M_AXI_DC	O	Master Protection type
M_AXI_DC_AWQOS	M_AXI_DC	O	Master Quality of Service
M_AXI_DC_AWVALID	M_AXI_DC	O	Master Write address valid
M_AXI_DC_AWREADY	M_AXI_DC	I	Slave Write address ready
M_AXI_DC_AWUSER	M_AXI_DC	O	Master Write address user signals
M_AXI_DC_AWDOMAIN	M_ACE_DC	O	Master Write address domain
M_AXI_DC_AWSNOOP	M_ACE_DC	O	Master Write address snoop
M_AXI_DC_AWBAR	M_ACE_DC	O	Master Write address barrier
M_AXI_DC_WDATA	M_AXI_DC	O	Master Write data
M_AXI_DC_WSTRB	M_AXI_DC	O	Master Write strobes
M_AXI_DC_WLAST	M_AXI_DC	O	Master Write last
M_AXI_DC_WVALID	M_AXI_DC	O	Master Write valid
M_AXI_DC_WREADY	M_AXI_DC	I	Slave Write ready
M_AXI_DC_WUSER	M_AXI_DC	O	Master Write user signals
M_AXI_DC_BRESP	M_AXI_DC	I	Slave Write response

Table 3-1: Summary of MicroBlaze Core I/O (Continued)

Signal	Interface	I/O	Description
M_AXI_DC_BID	M_AXI_DC	I	Slave Response ID
M_AXI_DC_BVALID	M_AXI_DC	I	Slave Write response valid
M_AXI_DC_BREADY	M_AXI_DC	O	Master Response ready
M_AXI_DC_BUSER	M_AXI_DC	I	Slave Write response user signals
M_AXI_DC_WACK	M_ACE_DC	O	Slave Write acknowledge
M_AXI_DC_ARID	M_AXI_DC	O	Master Read address ID
M_AXI_DC_ARADDR	M_AXI_DC	O	Master Read address
M_AXI_DC_ARLEN	M_AXI_DC	O	Master Burst length
M_AXI_DC_ARSIZE	M_AXI_DC	O	Master Burst size
M_AXI_DC_ARBURST	M_AXI_DC	O	Master Burst type
M_AXI_DC_ARLOCK	M_AXI_DC	O	Master Lock type
M_AXI_DC_ARCACHE	M_AXI_DC	O	Master Cache type
M_AXI_DC_ARPROT	M_AXI_DC	O	Master Protection type
M_AXI_DC_ARQOS	M_AXI_DC	O	Master Quality of Service
M_AXI_DC_ARVALID	M_AXI_DC	O	Master Read address valid
M_AXI_DC_ARREADY	M_AXI_DC	I	Slave Read address ready
M_AXI_DC_ARUSER	M_AXI_DC	O	Master Read address user signals
M_AXI_DC_ARDOMAIN	M_ACE_DC	O	Master Read address domain
M_AXI_DC_ARSNOOP	M_ACE_DC	O	Master Read address snoop
M_AXI_DC_ARBAR	M_ACE_DC	O	Master Read address barrier
M_AXI_DC_RID	M_AXI_DC	I	Slave Read ID tag
M_AXI_DC_RDATA	M_AXI_DC	I	Slave Read data
M_AXI_DC_RRESP	M_AXI_DC	I	Slave Read response
M_AXI_DC_RLAST	M_AXI_DC	I	Slave Read last
M_AXI_DC_RVALID	M_AXI_DC	I	Slave Read valid
M_AXI_DC_RREADY	M_AXI_DC	O	Master Read ready
M_AXI_DC_RUSER	M_AXI_DC	I	Slave Read user signals
M_AXI_DC_RACK	M_ACE_DC	O	Master Read acknowledge
M_AXI_DC_ACVALID	M_ACE_DC	I	Slave Snoop address valid
M_AXI_DC_ACADDR	M_ACE_DC	I	Slave Snoop address
M_AXI_DC_ACSNOOP	M_ACE_DC	I	Slave Snoop address snoop
M_AXI_DC_ACPROT	M_ACE_DC	I	Slave Snoop address protection type

**Table 3-1: Summary of MicroBlaze Core I/O (Continued)**

Signal	Interface	I/O	Description
M_AXI_DC_ACREADY	M_ACE_DC	O	Master Snoop ready
M_AXI_DC_CRREADY	M_ACE_DC	I	Slave Snoop response ready
M_AXI_DC_CRVALID	M_ACE_DC	O	Master Snoop response valid
M_AXI_DC_CRRESP	M_ACE_DC	O	Master Snoop response
M_AXI_DC_CDVALID	M_ACE_DC	O	Master Snoop data valid
M_AXI_DC_CDREADY	M_ACE_DC	I	Slave Snoop data ready
M_AXI_DC_CDDATA	M_ACE_DC	O	Master Snoop data
M_AXI_DC_CDLAST	M_ACE_DC	O	Master Snoop data last
M_AXI_IC_AWID	M_AXI_IC	O	Master Write address ID
M_AXI_IC_AWADDR	M_AXI_IC	O	Master Write address
M_AXI_IC_AWLEN	M_AXI_IC	O	Master Burst length
M_AXI_IC_AWSIZE	M_AXI_IC	O	Master Burst size
M_AXI_IC_AWBURST	M_AXI_IC	O	Master Burst type
M_AXI_IC_AWLOCK	M_AXI_IC	O	Master Lock type
M_AXI_IC_AWCACHE	M_AXI_IC	O	Master Cache type
M_AXI_IC_AWPROT	M_AXI_IC	O	Master Protection type
M_AXI_IC_AWQOS	M_AXI_IC	O	Master Quality of Service
M_AXI_IC_AWVALID	M_AXI_IC	O	Master Write address valid
M_AXI_IC_AWREADY	M_AXI_IC	I	Slave Write address ready
M_AXI_IC_AWUSER	M_AXI_IC	O	Master Write address user signals
M_AXI_IC_AWDOMAIN	M_ACE_IC	O	Master Write address domain
M_AXI_IC_AWSNOOP	M_ACE_IC	O	Master Write address snoop
M_AXI_IC_AWBAR	M_ACE_IC	O	Master Write address barrier
M_AXI_IC_WDATA	M_AXI_IC	O	Master Write data
M_AXI_IC_WSTRB	M_AXI_IC	O	Master Write strobes
M_AXI_IC_WLAST	M_AXI_IC	O	Master Write last
M_AXI_IC_WVALID	M_AXI_IC	O	Master Write valid
M_AXI_IC_WREADY	M_AXI_IC	I	Slave Write ready
M_AXI_IC_WUSER	M_AXI_IC	O	Master Write user signals
M_AXI_IC_BID	M_AXI_IC	I	Slave Response ID
M_AXI_IC_BRESP	M_AXI_IC	I	Slave Write response
M_AXI_IC_BVALID	M_AXI_IC	I	Slave Write response valid

Table 3-1: Summary of MicroBlaze Core I/O (Continued)

Signal	Interface	I/O	Description
M_AXI_IC_BREADY	M_AXI_IC	O	Master Response ready
M_AXI_IC_BUSER	M_AXI_IC	I	Slave Write response user signals
M_AXI_IC_WACK	M_ACE_IC	O	Slave Write acknowledge
M_AXI_IC_ARID	M_AXI_IC	O	Master Read address ID
M_AXI_IC_ARADDR	M_AXI_IC	O	Master Read address
M_AXI_IC_ARLEN	M_AXI_IC	O	Master Burst length
M_AXI_IC_ARSIZE	M_AXI_IC	O	Master Burst size
M_AXI_IC_ARBURST	M_AXI_IC	O	Master Burst type
M_AXI_IC_ARLOCK	M_AXI_IC	O	Master Lock type
M_AXI_IC_ARCACHE	M_AXI_IC	O	Master Cache type
M_AXI_IC_ARPROT	M_AXI_IC	O	Master Protection type
M_AXI_IC_ARQOS	M_AXI_IC	O	Master Quality of Service
M_AXI_IC_ARVALID	M_AXI_IC	O	Master Read address valid
M_AXI_IC_ARREADY	M_AXI_IC	I	Slave Read address ready
M_AXI_IC_ARUSER	M_AXI_IC	O	Master Read address user signals
M_AXI_IC_ARDOMAIN	M_ACE_IC	O	Master Read address domain
M_AXI_IC_ARSNOOP	M_ACE_IC	O	Master Read address snoop
M_AXI_IC_ARBAR	M_ACE_IC	O	Master Read address barrier
M_AXI_IC_RID	M_AXI_IC	I	Slave Read ID tag
M_AXI_IC_RDATA	M_AXI_IC	I	Slave Read data
M_AXI_IC_RRESP	M_AXI_IC	I	Slave Read response
M_AXI_IC_RLAST	M_AXI_IC	I	Slave Read last
M_AXI_IC_RVALID	M_AXI_IC	I	Slave Read valid
M_AXI_IC_RREADY	M_AXI_IC	O	Master Read ready
M_AXI_IC_RUSER	M_AXI_IC	I	Slave Read user signals
M_AXI_IC_RACK	M_ACE_IC	O	Master Read acknowledge
M_AXI_IC_ACVALID	M_ACE_IC	I	Slave Snoop address valid
M_AXI_IC_ACADDR	M_ACE_IC	I	Slave Snoop address
M_AXI_IC_ACSNOOP	M_ACE_IC	I	Slave Snoop address snoop
M_AXI_IC_ACPROT	M_ACE_IC	I	Slave Snoop address protection type
M_AXI_IC_ACREADY	M_ACE_IC	O	Master Snoop ready
M_AXI_IC_CRREADY	M_ACE_IC	I	Slave Snoop response ready

**Table 3-1: Summary of MicroBlaze Core I/O (Continued)**

Signal	Interface	I/O	Description
M_AXI_IC_CRVALID	M_ACE_IC	O	Master Snoop response valid
M_AXI_IC_CRRESP	M_ACE_IC	O	Master Snoop response
M_AXI_IC_CDVALID	M_ACE_IC	O	Master Snoop data valid
M_AXI_IC_CDREADY	M_ACE_IC	I	Slave Snoop data ready
M_AXI_IC_CDDATA	M_ACE_IC	O	Master Snoop data
M_AXI_IC_CDLAST	M_ACE_IC	O	Master Snoop data last
DPLB_M_Abort	DPLB	O	Data Interface PLB abort bus request indicator
DPLB_M_ABus	DPLB	O	Data Interface PLB address bus
DPLB_M_UABus	DPLB	O	Data Interface PLB upper address bus
DPLB_M_BE	DPLB	O	Data Interface PLB byte enables
DPLB_M_busLock	DPLB	O	Data Interface PLB bus lock
DPLB_M_lockErr	DPLB	O	Data Interface PLB lock error indicator
DPLB_M_MSize	DPLB	O	Data Interface PLB master data bus size
DPLB_M_priority	DPLB	O	Data Interface PLB bus request priority
DPLB_M_rdBurst	DPLB	O	Data Interface PLB burst read transfer indicator
DPLB_M_request	DPLB	O	Data Interface PLB bus request
DPLB_M_RNW	DPLB	O	Data Interface PLB read/not write
DPLB_M_size	DPLB	O	Data Interface PLB transfer size
DPLB_M_TAttribute	DPLB	O	Data Interface PLB Transfer Attribute bus
DPLB_M_type	DPLB	O	Data Interface PLB transfer type
DPLB_M_wrBurst	DPLB	O	Data Interface PLB burst write transfer indicator
DPLB_M_wrDBus	DPLB	O	Data Interface PLB write data bus
DPLB_MBusy	DPLB	I	Data Interface PLB slave busy indicator
DPLB_MRdErr	DPLB	I	Data Interface PLB slave read error indicator
DPLB_MWrErr	DPLB	I	Data Interface PLB slave write error indicator
DPLB_MIRQ	DPLB	I	Data Interface PLB slave interrupt indicator
DPLB_MWrBTerm	DPLB	I	Data Interface PLB terminate write burst indicator
DPLB_MWrDAck	DPLB	I	Data Interface PLB write data acknowledge

Table 3-1: Summary of MicroBlaze Core I/O (Continued)

Signal	Interface	I/O	Description
DPLB_MAddrAck	DPLB	I	Data Interface PLB address acknowledge
DPLB_MRdBTerm	DPLB	I	Data Interface PLB terminate read burst indicator
DPLB_MRdDAck	DPLB	I	Data Interface PLB read data acknowledge
DPLB_MRdDBus	DPLB	I	Data Interface PLB read data bus
DPLB_MRdWdAddr	DPLB	I	Data Interface PLB read word address
DPLB_MRearbitrate	DPLB	I	Data Interface PLB bus rearbitrate indicator
DPLB_MSSize	DPLB	I	Data Interface PLB slave data bus size
DPLB_MTimeout	DPLB	I	Data Interface PLB bus timeout
IPLB_M_Abort	IPLB	O	Instruction Interface PLB abort bus request indicator
IPLB_M_ABus	IPLB	O	Instruction Interface PLB address bus
IPLB_M_UABus	IPLB	O	Instruction Interface PLB upper address bus
IPLB_M_BE	IPLB	O	Instruction Interface PLB byte enables
IPLB_M_busLock	IPLB	O	Instruction Interface PLB bus lock
IPLB_M_lockErr	IPLB	O	Instruction Interface PLB lock error indicator
IPLB_M_MSize	IPLB	O	Instruction Interface PLB master data bus size
IPLB_M_priority	IPLB	O	Instruction Interface PLB bus request priority
IPLB_M_rdBurst	IPLB	O	Instruction Interface PLB burst read transfer indicator
IPLB_M_request	IPLB	O	Instruction Interface PLB bus request
IPLB_M_RNW	IPLB	O	Instruction Interface PLB read/not write
IPLB_M_size	IPLB	O	Instruction Interface PLB transfer size
IPLB_M_TAttribute	IPLB	O	Instruction Interface PLB Transfer Attribute bus
IPLB_M_type	IPLB	O	Instruction Interface PLB transfer type
IPLB_M_wrBurst	IPLB	O	Instruction Interface PLB burst write transfer indicator
IPLB_M_wrDBus	IPLB	O	Instruction Interface PLB write data bus
IPLB_MBusy	IPLB	I	Instruction Interface PLB slave busy indicator
IPLB_MRdErr	IPLB	I	Instruction Interface PLB slave read error indicator



**Table 3-1: Summary of MicroBlaze Core I/O (Continued)**

Signal	Interface	I/O	Description
IPLB_MWrErr	IPLB	I	Instruction Interface PLB slave write error indicator
IPLB_MIRQ	IPLB	I	Instruction Interface PLB slave interrupt indicator
IPLB_MWrBTerm	IPLB	I	Instruction Interface PLB terminate write burst indicator
IPLB_MWrDAck	IPLB	I	Instruction Interface PLB write data acknowledge
IPLB_MAddrAck	IPLB	I	Instruction Interface PLB address acknowledge
IPLB_MRdBTerm	IPLB	I	Instruction Interface PLB terminate read burst indicator
IPLB_MRdDAck	IPLB	I	Instruction Interface PLB read data acknowledge
IPLB_MRdDBus	IPLB	I	Instruction Interface PLB read data bus
IPLB_MRdWdAddr	IPLB	I	Instruction Interface PLB read word address
IPLB_MRearbitrate	IPLB	I	Instruction Interface PLB bus rearbitrate indicator
IPLB_MSSize	IPLB	I	Instruction Interface PLB slave data bus size
IPLB_MTimeout	IPLB	I	Instruction Interface PLB bus timeout
Data_Addr[0:31]	DLMB	O	Data interface LMB address bus
Byte_Enable[0:3]	DLMB	O	Data interface LMB byte enables
Data_Write[0:31]	DLMB	O	Data interface LMB write data bus
D_AS	DLMB	O	Data interface LMB address strobe
Read_Strobe	DLMB	O	Data interface LMB read strobe
Write_Strobe	DLMB	O	Data interface LMB write strobe
Data_Read[0:31]	DLMB	I	Data interface LMB read data bus
DReady	DLMB	I	Data interface LMB data ready
DWait	DLMB	I	Data interface LMB data wait
DCE	DLMB	I	Data interface LMB correctable error
DUE	DLMB	I	Data interface LMB uncorrectable error
Instr_Addr[0:31]	ILMB	O	Instruction interface LMB address bus
I_AS	ILMB	O	Instruction interface LMB address strobe
IFetch	ILMB	O	Instruction interface LMB instruction fetch
Instr[0:31]	ILMB	I	Instruction interface LMB read data bus

Table 3-1: Summary of MicroBlaze Core I/O (Continued)

Signal	Interface	I/O	Description
IReady	ILMB	I	Instruction interface LMB data ready
IWait	ILMB	I	Instruction interface LMB data wait
ICE	ILMB	I	Instruction interface LMB correctable error
IUE	ILMB	I	Instruction interface LMB uncorrectable error
Mn_AXIS_TLAST	M0_AXIS.. M15_AXIS	O	Master interface output AXI4 channels write last
Mn_AXIS_TDATA	M0_AXIS.. M15_AXIS	O	Master interface output AXI4 channels write data
Mn_AXIS_TVALID	M0_AXIS.. M15_AXIS	O	Master interface output AXI4 channels write valid
Mn_AXIS_TREADY	M0_AXIS.. M15_AXIS	I	Master interface input AXI4 channels write ready
Sn_AXIS_TLAST	S0_AXIS.. S15_AXIS	I	Slave interface input AXI4 channels write last
Sn_AXIS_TDATA	S0_AXIS.. S15_AXIS	I	Slave interface input AXI4 channels write data
Sn_AXIS_TVALID	S0_AXIS.. S15_AXIS	I	Slave interface input AXI4 channels write valid
Sn_AXIS_TREADY	S0_AXIS.. S15_AXIS	O	Slave interface output AXI4 channels write ready
FSL0_M .. FSL15_M	MFSL or DWFSL	O	Master interface to output FSL channels MFSL is used for FSL bus connections, whereas DWFSL is used for direct connections with FSL slaves
FSL0_S .. FSL15_S	SFSL or DRFSL	I	Slave interface to input FSL channels SFSL is used for FSL bus connections, whereas DRFSL is used for direct connections with FSL masters
ICache_FSL_in...	IXCL_S	IO	Instruction side CacheLink FSL slave interface
ICache_FSL_out...	IXCL_M	IO	Instruction side CacheLink FSL master interface
DCache_FSL_in...	DXCL_S	IO	Data side CacheLink FSL slave interface
DCache_FSL_out...	DXCL_M	IO	Data side CacheLink FSL master interface
Interrupt	Core	I	Interrupt
Interrupt_Address <sup>1</sup>	Core	I	Interrupt vector address
Interrupt_Ack <sup>1</sup>	Core	O	Interrupt acknowledge

**Table 3-1: Summary of MicroBlaze Core I/O (Continued)**

Signal	Interface	I/O	Description
Reset <sup>2</sup>	Core	I	Core reset, active high. Should be held for at least 1 Clk clock cycle.
MB_Reset <sup>2</sup>	Core	I	Core reset, active high. Should be held for at least 1 Clk clock cycle.
Clk	Core	I	Clock <sup>3</sup>
Ext_BRK	Core	I	Break signal from MDM
Ext_NM_BRK	Core	I	Non-maskable break signal from MDM
MB_Halted	Core	O	Pipeline is halted, either via the Debug Interface or by setting Dbg_Stop
Dbg_Stop	Core	I	Unconditionally force pipeline to halt as soon as possible. Rising-edge detected pulse that should be held for at least 1 Clk clock cycle. The signal only has any effect when C_DEBUG_ENABLED is set to 1.
MB_Error	Core	O	Pipeline is halted due to a missed exception, when C_FAULT_TOLERANT is set to 1.
Sleep	Core	O	MicroBlaze is in sleep mode after executing a SLEEP instruction, all external accesses are completed, and the pipeline is halted.
Wakeup [0:1]	Core	I	Wake MicroBlaze from sleep mode when either or both bits are set to 1. Ignored if MicroBlaze is not in sleep mode.
Dbg_Wakeup	Core	O	Debug request that external logic should wake MicroBlaze from sleep mode with the Wakeup signal.
Lockstep_...	Core	IO	Lockstep signals for high integrity applications. See <a href="#">Table 3-13</a> for details.
Dbg_...	Core	IO	Debug signals from MDM. See <a href="#">Table 3-15</a> for details.
Trace_...	Core	O	Trace signals for real time HW analysis. See <a href="#">Table 3-16</a> for details.

1. Only used with C\_USE\_INTERRUPT = 2, for low-latency interrupt support.
2. The Reset and MB\_Reset signals are functionally equivalent. MB\_Reset is intended for the AXI4 and PLB interfaces.
3. MicroBlaze is a synchronous design clocked with the Clk signal, except for hardware debug logic, which is clocked with the Dbg\_Clk signal. If hardware debug logic is not used, there is no minimum frequency limit for Clk. However, if hardware debug logic is used, there are signals transferred between the two clock regions. In this case Clk must have a higher frequency than Dbg\_Clk.

# AXI4 and ACE Interface Description

## Memory Mapped Interfaces

### Peripheral Interfaces

The MicroBlaze AXI4 memory mapped peripheral interfaces are implemented as 32-bit masters. Each of these interfaces only have a single outstanding transaction at any time, and all transactions are completed in order.

- The instruction peripheral interface (M\_AXI\_IP) only performs single word read accesses, and is always set to use the AXI4-Lite subset.
- The data peripheral interface (M\_AXI\_DP) performs single word accesses, and is set to use the AXI4-Lite subset as default, but is set to use AXI4 when enabling exclusive access for LWX and SWX instructions. Halfword and byte writes are performed by setting the appropriate byte strobes.

### Cache Interfaces

The AXI4 and ACE memory mapped cache interfaces are implemented either as 32-bit, 128-bit, 256-bit, or 512-bit masters, depending on cache line length and data width parameters.

- With a 32-bit master, the instruction cache interface (M\_AXI\_IC or M\_ACE\_IC) performs 4 word or 8 word burst read accesses, depending on cache line length. With 128-bit, 256-bit, or 512-bit masters, only single read accesses are performed.

This interface can have multiple outstanding transactions, issuing up to 2 transactions or up to 5 transactions when stream cache is enabled. The stream cache can request two cache lines in advance, which means that in some cases 5 outstanding transactions can occur. When stream cache is enabled, C\_INTERCONNECT\_M\_AXI\_IC\_READ\_ISSUING is set to 8, since it must be a power of two.

How memory locations are accessed depend on the parameter C\_ICACHE\_ALWAYS\_USED. If the parameter is 1, the cached memory range is always accessed via the AXI4 or ACE cache interface. If the parameter is 0, the cached memory range is accessed over the AXI4 peripheral interface when the caches are software disabled (that is, MSR[ICE]=0).

- With a 32-bit master, the data cache interface (M\_AXI\_DC or M\_ACE\_DC) performs single word accesses, as well as 4 word or 8 word burst accesses, depending on cache line length. Burst write accesses are only performed when using write-back cache. With 128-bit, 256-bit, or 512-bit masters, only single accesses are performed.

This interface can have multiple outstanding transactions, either issuing up to 2 transactions when reading, or up to 32 transactions when writing. MicroBlaze ensures that all outstanding writes are completed before a read is issued, since the processor must maintain an ordered memory model but AXI or ACE has separate read/write channels without any ordering. Using up to 32 outstanding write transactions improves performance, since it allows multiple writes to proceed without stalling the pipeline.

Word, halfword and byte writes are performed by setting the appropriate byte strobes.

Exclusive accesses can be enabled for LWX and SWX instructions.

How memory locations are accessed depend on the parameter C\_DCACHE\_ALWAYS\_USED. If the parameter is 1, the cached memory range is always accessed via the AXI4 or ACE cache interface. If the parameter is 0, the cached memory range is accessed over the AXI4 peripheral interface when the caches are software disabled (that is, MSR[DCE]=0).

## Interface Parameters and Signals

The relationship between MicroBlaze parameter settings and AXI4 interface behavior for tool-assigned parameters is summarized in [Table 3-2](#).

**Table 3-2: AXI Memory Mapped Interface Parameters**

Interface	Parameter	Description
M_AXI_DP	C_M_AXI_DP_PROTOCOL	<b>AXI4-Lite:</b> Default. <b>AXI4:</b> Used to allow exclusive access when C_M_AXI_DP_EXCLUSIVE_ACCESS is 1.
M_AXI_IC M_ACE_IC	C_M_AXI_IC_DATA_WIDTH	<b>32:</b> Default, single word accesses and burst accesses with C_ICACHE_LINE_LEN word busts used. <b>128:</b> Used when C_ICACHE_DATA_WIDTH is set to 1 and C_ICACHE_LINE_LEN is set to 4. Only single accesses can occur. <b>256:</b> Used when C_ICACHE_DATA_WIDTH is set to 1 and C_ICACHE_LINE_LEN is set to 8. Only single accesses can occur. <b>512:</b> Used when C_ICACHE_DATA_WIDTH is set to 2. Only single accesses can occur.
M_AXI_DC M_ACE_DC	C_M_AXI_DC_DATA_WIDTH	<b>32:</b> Default, single word accesses and burst accesses with C_DCACHE_LINE_LEN word busts used. Write bursts are only used when C_DCACHE_USE_WRITEBACK is set to 1. <b>128:</b> Used when C_DCACHE_DATA_WIDTH is set to 1 and C_DCACHE_LINE_LEN is set to 4. Only single accesses can occur. <b>256:</b> Used when C_DCACHE_DATA_WIDTH is set to 1 and C_DCACHE_LINE_LEN is set to 8. Only single accesses can occur. <b>512:</b> Used when C_DCACHE_DATA_WIDTH is set to 2. Only single accesses can occur.
M_AXI_IC M_ACE_IC	C_INTERCONNECT_M_AXI_IC_READ_ISSUING <sup>1</sup>	<b>2:</b> Default, 2 simultaneous outstanding reads. <b>8:</b> Used when C_ICACHE_STREAMS is set to 1, allowing 8 simultaneous outstanding reads. Can be set to 1, 2, 4, 8.
M_AXI_DC M_ACE_DC	C_INTERCONNECT_M_AXI_DC_READ_ISSUING <sup>1</sup>	<b>2:</b> Default, 2 simultaneous outstanding reads. Can be set to 1 or 2.
M_AXI_DC M_ACE_DC	C_INTERCONNECT_M_AXI_DC_WRITE_ISSUING <sup>1</sup>	<b>32:</b> Default, 32 simultaneous outstanding writes. Can be set to 1, 2, 4, 8, 16, or 32.

1. This value can be explicitly set by the user to limit the number of simultaneous accesses accepted by the interconnect, which may lower performance but can reduce the interconnect size.

Values for access permissions, memory types, quality of service and shareability domain are defined in [Table 3-3](#).

**Table 3-3: AXI Interface Signal Definitions**

Interface	Signal	Description
M_AXI_IP	C_M_AXI_IP_ARPROT	Access Permission: <ul style="list-style-type: none"> <li>Unprivileged, secure instruction access (100)</li> </ul>
M_AXI_DP	C_M_AXI_DP_ARCACHE C_M_AXI_DP_AWCACHE	Memory Type, AXI4 protocol: <ul style="list-style-type: none"> <li>Normal Non-cacheable Bufferable (0011)</li> </ul>
	C_M_AXI_DP_ARPROT C_M_AXI_DP_AWPROT	Access Permission, AXI4 and AXI4-Lite protocol: <ul style="list-style-type: none"> <li>Unprivileged, secure data access (000)</li> </ul>
	C_M_AXI_DP_ARQOS C_M_AXI_DP_AWQOS	Quality of Service, AXI4 protocol: <ul style="list-style-type: none"> <li>Priority 8 (1000)</li> </ul>
M_AXI_IC	C_M_AXI_IC_ARCACHE	Memory Type: <ul style="list-style-type: none"> <li>Write-back Read and Write-allocate (1111)</li> </ul>
M_ACE_IC	C_M_AXI_IC_ARCACHE	Memory Type, normal access: <ul style="list-style-type: none"> <li>Write-back Read and Write-allocate (1111)</li> </ul> Memory Type, DVM access: <ul style="list-style-type: none"> <li>Normal Non-cacheable Non-bufferable (0010)</li> </ul>
	C_M_AXI_IC_ARDOMAIN	Shareability Domain: <ul style="list-style-type: none"> <li>Inner shareable (01)</li> </ul>
M_AXI_IC M_ACE_IC	C_M_AXI_IC_ARPROT	Access Permission: <ul style="list-style-type: none"> <li>Unprivileged, secure instruction access (100)</li> </ul>
	C_M_AXI_IC_ARQOS	Quality of Service: <ul style="list-style-type: none"> <li>Priority 7 (0111)</li> </ul>
M_AXI_DC	C_M_AXI_DC_ARCACHE	Memory Type, normal access: <ul style="list-style-type: none"> <li>Write-back Read and Write-allocate (1111)</li> </ul> Memory Type, exclusive access: <ul style="list-style-type: none"> <li>Normal Non-cacheable Non-bufferable (0010)</li> </ul>
M_ACE_DC	C_M_AXI_DC_ARCACHE	Memory Type, normal and exclusive access: <ul style="list-style-type: none"> <li>Write-back Read and Write-allocate (1111)</li> </ul> Memory Type, DVM access: <ul style="list-style-type: none"> <li>Normal Non-cacheable Non-bufferable (0010)</li> </ul>
	C_M_AXI_DC_ARDOMAIN C_M_AXI_DC_AWDOMAIN	Shareability Domain: <ul style="list-style-type: none"> <li>Inner shareable (01)</li> </ul>

Table 3-3: AXI Interface Signal Definitions

Interface	Signal	Description
M_AXI_DC M_ACE_DC	C_M_AXI_DC_AWCACHE	Memory Type, normal access: <ul style="list-style-type: none"> <li>• Write-back Read and Write-allocate (1111)</li> </ul> Memory Type, exclusive access: <ul style="list-style-type: none"> <li>• Normal Non-cacheable Non-bufferable (0010)</li> </ul>
	C_M_AXI_DC_ARPROT C_M_AXI_DC_AWPROT	Access Permission: <ul style="list-style-type: none"> <li>• Unprivileged, secure data access (000)</li> </ul>
	C_M_AXI_DC_ARQOS	Quality of Service, read access: <ul style="list-style-type: none"> <li>• Priority 12 ((1100)</li> </ul>
	C_M_AXI_DC_AWQOS	Quality of Service, write access: <ul style="list-style-type: none"> <li>• Priority 8 (1000)</li> </ul>

Please refer to the *AMBA® AXI and ACE Protocol Specification, ARM IHI 0022E* document for details.

## Stream Interfaces

The MicroBlaze AXI4-Stream interfaces (M0\_AXIS..M15\_AXIS, S0\_AXIS..S15\_AXIS) are implemented as 32-bit masters and slaves. Please refer to the *AMBA®4 AXI4-Stream Protocol Specification, Version 1.0, ARM IHI 0051A* document for further details.

The Mn\_AXIS\_TLAST and Sn\_AXIS\_TLAST signals directly correspond to the equivalent FSLn\_M\_Control and FSLn\_S\_Control signals, respectively.

### Write Operation

A write to the stream interface is performed by MicroBlaze using one of the put or putd instructions. A write operation transfers the register contents to an output AXI4 interface. The transfer is completed in a single clock cycle for blocking mode writes (put and cput instructions) as long as the interface is not busy. If the interface is busy, the processor stalls until it becomes available. The non-blocking instructions (with prefix n), always complete in a single clock cycle even if the interface is busy. If the interface was busy, the write is inhibited and the carry bit is set in the MSR.

### Read Operation

A read from the stream interface is performed by MicroBlaze using one of the get or getd instructions. A read operations transfers the contents of an input AXI4 interface to a general purpose register. The transfer is typically completed in 2 clock cycles for blocking mode reads as long as data is available. If data is not available, the processor stalls at this instruction until it becomes available. In the non-blocking mode (instructions with prefix n), the transfer is completed in one or two clock cycles irrespective of whether or not data was available. In case data was not available, the transfer of data does not take place and the carry bit is set in the MSR.

## Processor Local Bus (PLB) Interface Description

The MicroBlaze PLB interfaces are implemented as byte-enable capable 32-bit masters. Please refer to the *IBM 128-Bit Processor Local Bus Architectural Specification (v4.6)* document for details.

## Local Memory Bus (LMB) Interface Description

The LMB is a synchronous bus used primarily to access on-chip block RAM. It uses a minimum number of control signals and a simple protocol to ensure that local block RAM are accessed in a single clock cycle. LMB signals and definitions are shown in the following table. All LMB signals are active high.

### LMB Signal Interface

Table 3-4: LMB Bus Signals

Signal	Data Interface	Instruction Interface	Type	Description
Addr[0:31]	Data_Addr[0:31]	Instr_Addr[0:31]	O	Address bus
Byte_Enable[0:3]	Byte_Enable[0:3]	<i>not used</i>	O	Byte enables
Data_Write[0:31]	Data_Write[0:31]	<i>not used</i>	O	Write data bus
AS	D_AS	I_AS	O	Address strobe
Read_Strobe	Read_Strobe	IFetch	O	Read in progress
Write_Strobe	Write_Strobe	<i>not used</i>	O	Write in progress
Data_Read[0:31]	Data_Read[0:31]	Instr[0:31]	I	Read data bus
Ready	DReady	IReady	I	Ready for next transfer
Wait <sup>1</sup>	DWait	IWait	I	Wait until accepted transfer is ready
CE <sup>1</sup>	DCE	ICE	I	Correctable error
UE <sup>1</sup>	DUE	IUE	I	Uncorrectable error
Clk	Clk	Clk	I	Bus clock

1. Added in LMB for MicroBlaze v8.00

#### Addr[0:31]

The address bus is an output from the core and indicates the memory address that is being accessed by the current transfer. It is valid only when AS is high. In multicycle accesses (accesses requiring more than one clock cycle to complete), Addr[0:31] is valid only in the first clock cycle of the transfer.

#### Byte\_Enable[0:3]

The byte enable signals are outputs from the core and indicate which byte lanes of the data bus contain valid data. Byte\_Enable[0:3] is valid only when AS is high. In multicycle accesses (accesses requiring more than one clock cycle to complete), Byte\_Enable[0:3] is valid only in the first clock cycle of the transfer. Valid values for Byte\_Enable[0:3] are shown in the following table:



Table 3-5: Valid Values for Byte\_Enable[0:3]

Byte_Enable[0:3]	Byte Lanes Used			
	Data[0:7]	Data[8:15]	Data[16:23]	Data[24:31]
0001				●
0010			●	
0100		●		
1000	●			
0011			●	●
1100	●	●		
1111	●	●	●	●

### Data\_Write[0:31]

The write data bus is an output from the core and contains the data that is written to memory. It is valid only when AS is high. Only the byte lanes specified by Byte\_Enable[0:3] contain valid data.

### AS

The address strobe is an output from the core and indicates the start of a transfer and qualifies the address bus and the byte enables. It is high only in the first clock cycle of the transfer, after which it goes low and remains low until the start of the next transfer.

### Read\_Strobe

The read strobe is an output from the core and indicates that a read transfer is in progress. This signal goes high in the first clock cycle of the transfer, and may remain high until the clock cycle after Ready is sampled high. If a new read transfer is directly started in the next clock cycle, then Read\_Strobe remains high.

### Write\_Strobe

The write strobe is an output from the core and indicates that a write transfer is in progress. This signal goes high in the first clock cycle of the transfer, and may remain high until the clock cycle after Ready is sampled high. If a new write transfer is directly started in the next clock cycle, then Write\_Strobe remains high.

### Data\_Read[0:31]

The read data bus is an input to the core and contains data read from memory. Data\_Read[0:31] is valid on the rising edge of the clock when Ready is high.

### Ready

The Ready signal is an input to the core and indicates completion of the current transfer and that the next transfer can begin in the following clock cycle. It is sampled on the rising edge of the clock. For reads, this signal indicates the Data\_Read[0:31] bus is valid, and for writes it indicates that the Data\_Write[0:31] bus has been written to local memory.

## Wait

The `Wait` signal is an input to the core and indicates that the current transfer has been accepted, but not yet completed. It is sampled on the rising edge of the clock.

## CE

The `CE` signal is an input to the core and indicates that the current transfer had a correctable error. It is valid on the rising edge of the clock when `Ready` is high. For reads, this signal indicates that an error has been corrected on the `Data_Read [0 : 31]` bus, and for byte and halfword writes it indicates that the corresponding data word in local memory has been corrected before writing the new data.

## UE

The `UE` signal is an input to the core and indicates that the current transfer had an uncorrectable error. It is valid on the rising edge of the clock when `Ready` is high. For reads, this signal indicates that the value of the `Data_Read [0 : 31]` bus is erroneous, and for byte and halfword writes it indicates that the corresponding data word in local memory was erroneous before writing the new data.

## Clk

All operations on the LMB are synchronous to the MicroBlaze core clock.

## LMB Transactions

The following diagrams provide examples of LMB bus operations.

### Generic Write Operations

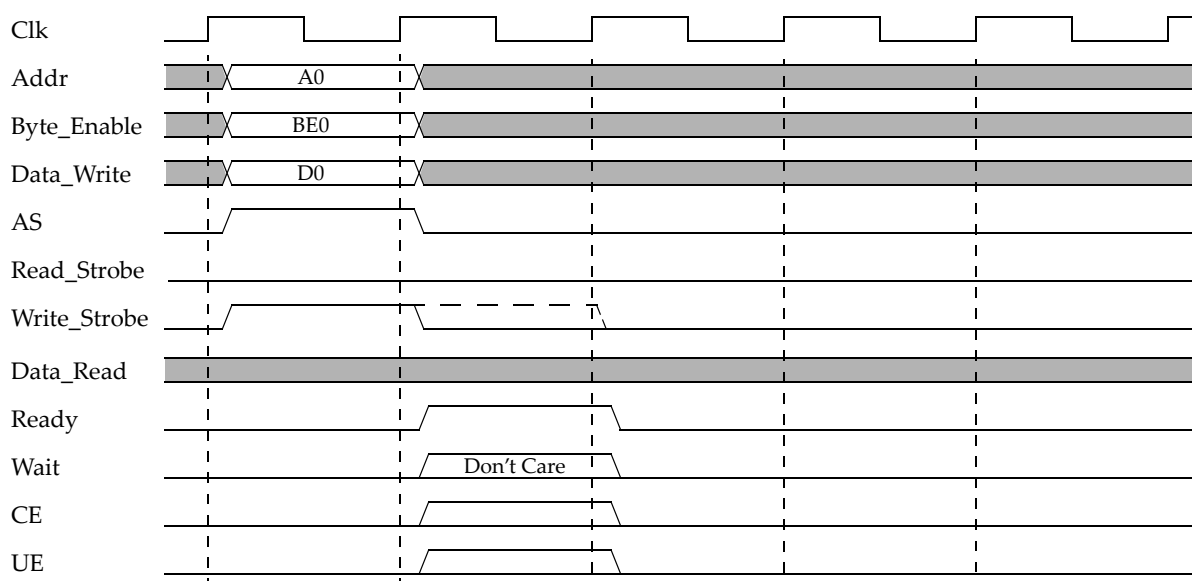

Figure 3-2: LMB Generic Write Operation, 0 Wait States

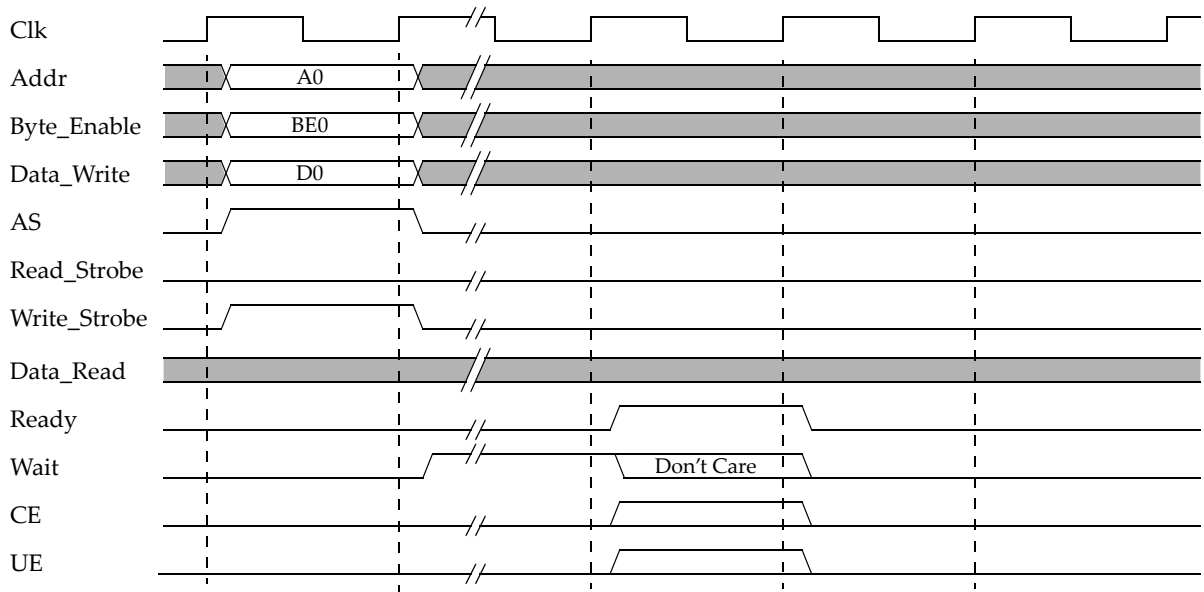

Figure 3-3: LMB Generic Write Operation, N Wait States

### Generic Read Operations

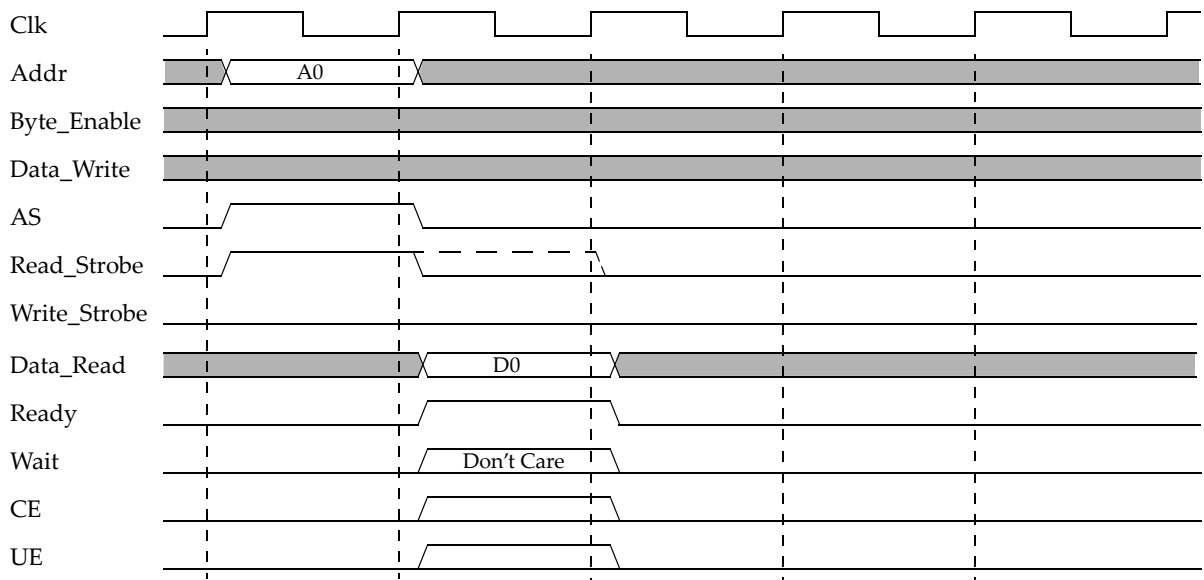

Figure 3-4: LMB Generic Read Operation, 0 Wait States

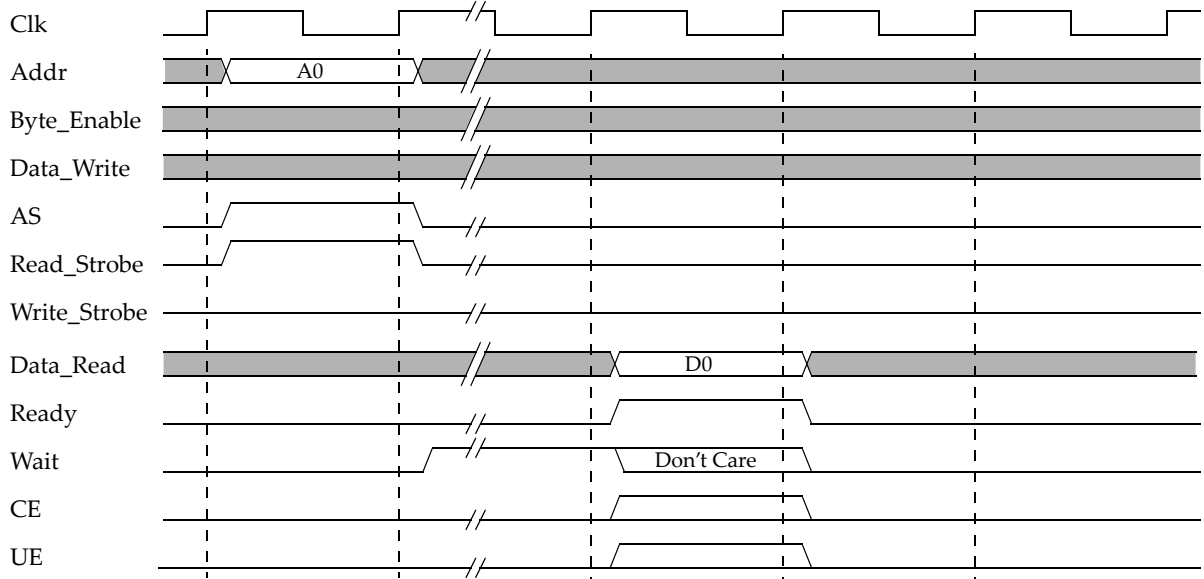

Figure 3-5: LMB Generic Read Operation, N Wait States

### Back-to-Back Write Operation

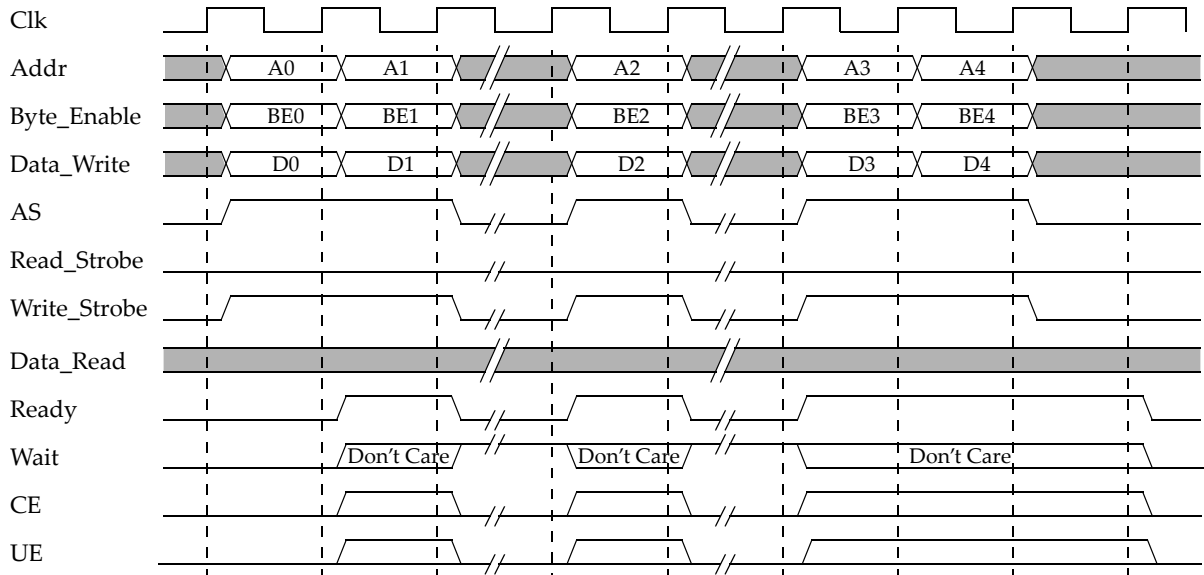

Figure 3-6: LMB Back-to-Back Write Operation

### Back-to-Back Read Operation

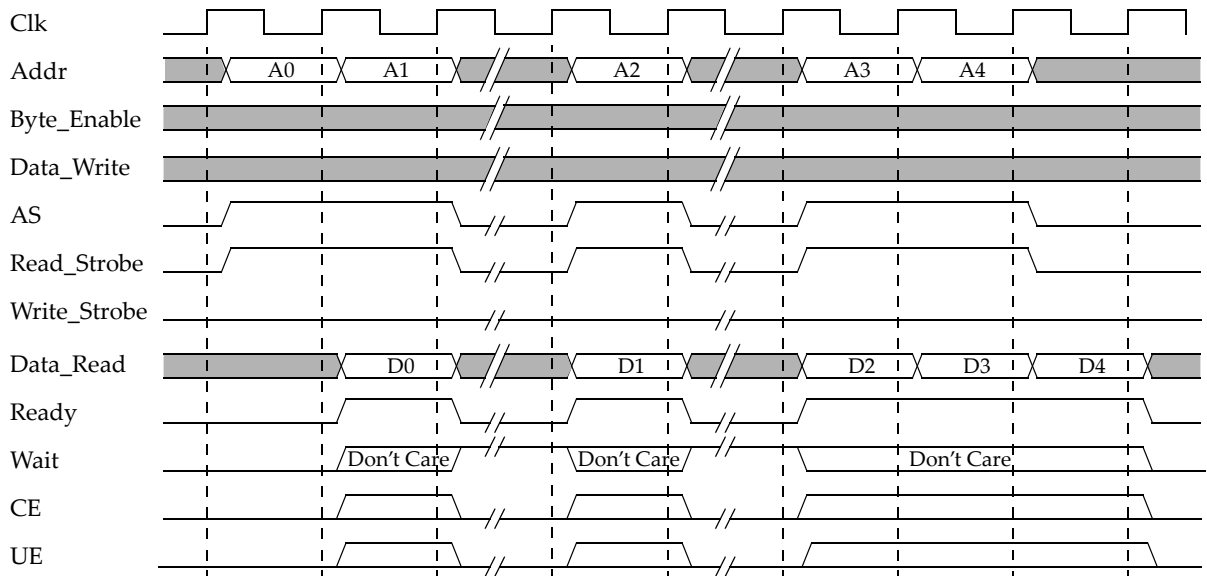

Figure 3-7: LMB Back-to-Back Read Operation

### Back-to-Back Mixed Write/Read Operation

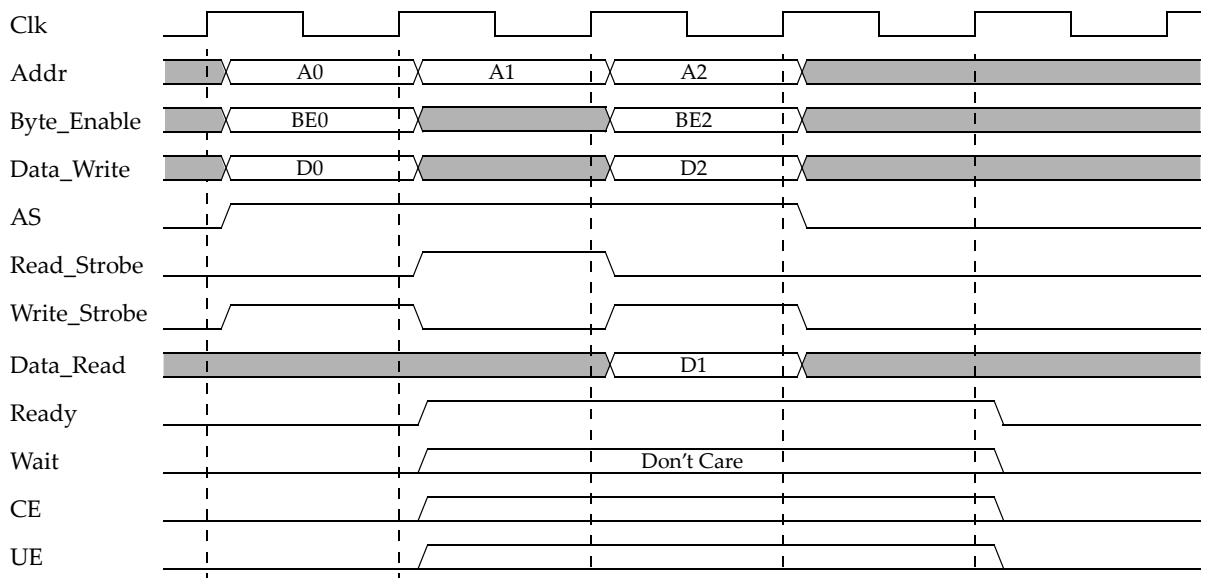

Figure 3-8: Back-to-Back Mixed Write/Read Operation, 0 Wait States

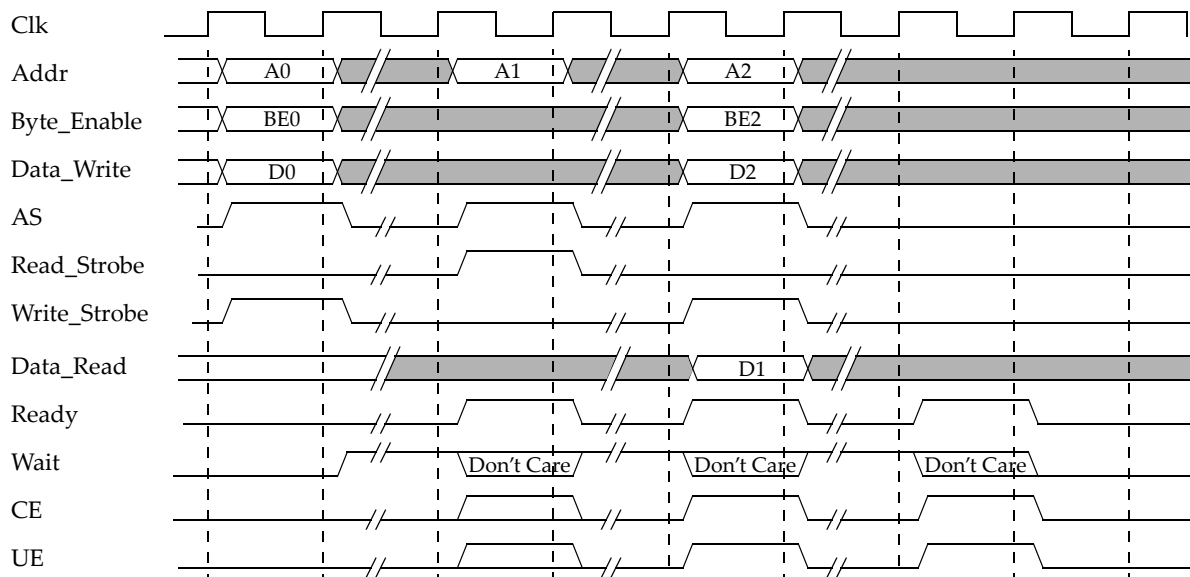

Figure 3-9: Back-to-Back Mixed Write/Read Operation, N Wait States

## Read and Write Data Steering

The MicroBlaze data-side bus interface performs the read steering and write steering required to support the following transfers:

- byte, halfword, and word transfers to word devices
- byte and halfword transfers to halfword devices
- byte transfers to byte devices

MicroBlaze does not support transfers that are larger than the addressed device. These types of transfers require dynamic bus sizing and conversion cycles that are not supported by the MicroBlaze bus interface. Data steering for read cycles are shown in [Table 3-6](#) and [Table 3-7](#), and data steering for write cycles are shown in [Table 3-8](#) and [Table 3-9](#).

**Table 3-6: Big Endian Read Data Steering (Load to Register rD)**

Address [30:31]	Byte_Enable [0:3]	Transfer Size	Register rD Data			
			rD[0:7]	rD[8:15]	rD[16:23]	rD[24:31]
11	0001	byte				Byte3
10	0010	byte				Byte2
01	0100	byte				Byte1
00	1000	byte				Byte0
10	0011	halfword			Byte2	Byte3
00	1100	halfword			Byte0	Byte1
00	1111	word	Byte0	Byte1	Byte2	Byte3

**Table 3-7: Little Endian Read Data Steering (Load to Register rD)**

Address [30:31]	Byte_Enable [0:3]	Transfer Size	Register rD Data			
			rD[0:7]	rD[8:15]	rD[16:23]	rD[24:31]
11	1000	byte				Byte0
10	0100	byte				Byte1
01	0010	byte				Byte2
00	0001	byte				Byte3
10	1100	halfword			Byte0	Byte1
00	0011	halfword			Byte2	Byte3
00	1111	word	Byte0	Byte1	Byte2	Byte3

Table 3-8: Big Endian Write Data Steering (Store from Register rD)

Address [30:31]	Byte_Enable [0:3]	Transfer Size	Write Data Bus Bytes			
			Byte0	Byte1	Byte2	Byte3
11	0001	byte				rD[24:31]
10	0010	byte			rD[24:31]	
01	0100	byte		rD[24:31]		
00	1000	byte	rD[24:31]			
10	0011	halfword			rD[16:23]	rD[24:31]
00	1100	halfword	rD[16:23]	rD[24:31]		
00	1111	word	rD[0:7]	rD[8:15]	rD[16:23]	rD[24:31]

Table 3-9: Little Endian Write Data Steering (Store from Register rD)

Address [30:31]	Byte_Enable [0:3]	Transfer Size	Write Data Bus Bytes			
			Byte3	Byte2	Byte1	Byte0
11	1000	byte	rD[24:31]			
10	0100	byte		rD[24:31]		
01	0010	byte			rD[24:31]	
00	0001	byte				rD[24:31]
10	1100	halfword	rD[16:23]	rD[24:31]		
00	0011	halfword			rD[16:23]	rD[24:31]
00	1111	word	rD[0:7]	rD[8:15]	rD[16:23]	rD[24:31]

**Note:** Other masters may have more restrictive requirements for byte lane placement than those allowed by MicroBlaze. Slave devices are typically attached “left-justified” with byte devices attached to the most-significant byte lane, and halfword devices attached to the most significant halfword lane. The MicroBlaze steering logic fully supports this attachment method.



## Fast Simplex Link (FSL) Interface Description

The Fast Simplex Link bus provides a point-to-point communication channel between an output FIFO and an input FIFO. For more information on the generic FSL protocol, see the *Fast Simplex Link (FSL) Bus (DS449)* data-sheet in the Xilinx EDK IP Documentation.

### Master FSL Signal Interface

MicroBlaze may contain up to 16 master FSL interfaces. The master signals are depicted in [Table 3-10](#).

**Table 3-10: Master FSL Signals**

Signal Name	Description	VHDL Type	Direction
FSLn_M_Clk	Clock	std_logic	input
FSLn_M_Write	Write enable signal indicating that data is being written to the output FSL	std_logic	output
FSLn_M_Data	Data value written to the output FSL	std_logic_vector	output
FSLn_M_Control	Control bit value written to the output FSL	std_logic	output
FSLn_M_Full	Full Bit indicating output FSL FIFO is full when set	std_logic	input

### Slave FSL Signal Interface

MicroBlaze may contain up to 16 slave FSL interfaces. The slave FSL interface signals are depicted in [Table 3-11](#).

**Table 3-11: Slave FSL Signals**

Signal Name	Description	VHDL Type	Direction
FSLn_S_Clk	Clock	std_logic	input
FSLn_S_Read	Read acknowledge signal indicating that data has been read from the input FSL	std_logic	output
FSLn_S_Data	Data value currently available at the top of the input FSL	std_logic_vector	input
FSLn_S_Control	Control Bit value currently available at the top of the input FSL	std_logic	input
FSLn_S_Exists	Flag indicating that data exists in the input FSL	std_logic	input

## FSL Transactions

### FSL BUS Write Operation

A write to the FSL bus is performed by MicroBlaze using one of the put or putd instructions. A write operation transfers the register contents to an output FSL bus. The transfer is completed in a single clock cycle for blocking mode writes to the FSL (put and cput instructions) as long as the FSL FIFO does not become full. If the FSL FIFO is full, the processor stalls until the FSL full flag is lowered. The non-blocking instructions (with prefix n), always complete in a single clock cycle even if the FSL was full. If the FSL was full, the write is inhibited and the carry bit is set in the MSR.

### FSL BUS Read Operation

A read from the FSL bus is performed by MicroBlaze using one of the get or getd instructions. A read operation transfers the contents of an input FSL to a general purpose register. The transfer is typically completed in 2 clock cycles for blocking mode reads from the FSL as long as data exists in the FSL FIFO. If the FSL FIFO is empty, the processor stalls at this instruction until the FSL exists flag is set. In the non-blocking mode (instructions with prefix n), the transfer is completed in one or two clock cycles irrespective of whether or not the FSL was empty. In the case the FSL was empty, the transfer of data does not take place and the carry bit is set in the MSR.

## Direct FSL Connections

A direct FSL connection can be used to avoid the need for the FSL bus. This can be useful in case no buffering is needed between the two connected IP cores, since the FSL bus FIFO is not included with a direct connection. No buffering reduces the communication latency and required implementation resources.

Each of the MicroBlaze FSL interfaces can either use a direct FSL connection or an FSL bus.

A MicroBlaze DWFSL interface is the initiator on a direct FSL connection, which can only be connected to a DWFSL target. The DWFSL initiator and target have exactly the same signal names, identical to the MFSL signals, depicted in [Table 3-10](#). MicroBlaze uses the DWFSL interface to write data to the target with one of the put or putd instructions.

A MicroBlaze DRFSL interface is the target on a direct FSL connection, which can only be connected to a DRFSL initiator. The DRFSL initiator and target have exactly the same signal names, identical to the SFSL signals, depicted in [Table 3-11](#). MicroBlaze uses the DRFSL interface to read data from the initiator with one of the get or getd instructions.

The Xilinx CacheLink (XCL) interface is implemented with direct FSL connections.

# Xilinx CacheLink (XCL) Interface Description

Xilinx CacheLink (XCL) is a high performance solution for external memory accesses. The MicroBlaze CacheLink interface is designed to connect directly to a memory controller with integrated FSL buffers, for example, the MPMC. This method has the lowest latency and minimal number of instantiations (see Figure 3-10).

### Schematic

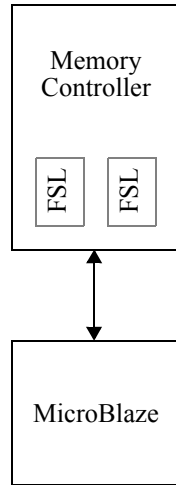

### Example MHS code

```

BEGIN microblaze
  ...
  BUS_INTERFACE IXCL = myIXCL
  ...
END
BEGIN mpmc
  ...
  BUS_INTERFACE XCL0 = myIXCL
  ...
END
    
```

Figure 3-10: CacheLink Connection with Integrated FSL Buffers (Only Instruction Cache Used in this Example)

The interface is only available on MicroBlaze when caches are enabled. It is legal to use a CacheLink cache on the instruction side or the data side without caching the other.

How memory locations are accessed depend on the parameter `C_ICACHE_ALWAYS_USED` for the instruction cache and the parameter `C_DCACHE_ALWAYS_USED` for the data cache. If the parameter is 1, the cached memory range is always accessed via the CacheLink. If the parameter is 0, the cached memory range is accessed over PLB whenever the caches are software disabled (that is, `MSR[ICE]=0` or `MSR[DCE]=0`).

Memory locations outside the cacheable range are accessed over PLB or LMB.

The CacheLink cache controllers handle 4 or 8-word cache lines, either using critical word first or linear fetch depending on the selected protocol. At the same time the separation from the PLB bus reduces contention for non-cached memory accesses.

## CacheLink Signal Interface

The CacheLink signals on MicroBlaze are listed in Table 3-12.

Table 3-12: MicroBlaze Cache Link Signals

Signal Name	Description	VHDL Type	Direction
ICACHE_FSL_IN_Clk	Clock output to I-side return read data FSL	std_logic	output
ICACHE_FSL_IN_Read	Read signal to I-side return read data FSL.	std_logic	output

Table 3-12: MicroBlaze Cache Link Signals (Continued)

Signal Name	Description	VHDL Type	Direction
ICACHE_FSL_IN_Data	Read data from I-side return read data FSL	std_logic_vector (0 to 31)	input
ICACHE_FSL_IN_Control	FSL control-bit from I-side return read data FSL. Reserved for future use	std_logic	input
ICACHE_FSL_IN_Exists	More read data exists in I-side return FSL	std_logic	input
ICACHE_FSL_OUT_Clk	Clock output to I-side read access FSL	std_logic	output
ICACHE_FSL_OUT_Write	Write new cache miss access request to I-side read access FSL	std_logic	output
ICACHE_FSL_OUT_Data	Cache miss access (=address) to I-side read access FSL	std_logic_vector (0 to 31)	output
ICACHE_FSL_OUT_Control	FSL control-bit to I-side read access FSL. Reserved for future use	std_logic	output
ICACHE_FSL_OUT_Full	FSL access buffer for I-side read accesses is full	std_logic	input
DCACHE_FSL_IN_Clk	Clock output to D-side return read data FSL	std_logic	output
DCACHE_FSL_IN_Read	Read signal to D-side return read data FSL	std_logic	output
DCACHE_FSL_IN_Data	Read data from D-side return read data FSL	std_logic_vector (0 to 31)	input
DCACHE_FSL_IN_Control	FSL control bit from D-side return read data FSL	std_logic	input
DCACHE_FSL_IN_Exists	More read data exists in D-side return FSL	std_logic	input
DCACHE_FSL_OUT_Clk	Clock output to D-side read access FSL	std_logic	output
DCACHE_FSL_OUT_Write	Write new cache miss access request to D-side read access FSL	std_logic	output
DCACHE_FSL_OUT_Data	Cache miss access (read address or write address + write data + byte write enable + burst write encoding) to D-side read access FSL	std_logic_vector (0 to 31)	output

Table 3-12: MicroBlaze Cache Link Signals (Continued)

Signal Name	Description	VHDL Type	Direction
DCACHE_FSL_OUT_Control	FSL control-bit to D-side read access FSL. Used with address bits [30 to 31] for read/write, byte enable and burst write encoding.	std_logic	output
DCACHE_FSL_OUT_Full	FSL access buffer for D-side read accesses is full	std_logic	input

## CacheLink Transactions

All individual CacheLink accesses follow the FSL FIFO based transaction protocol:

- Access information is encoded over the FSL data and control signals (e.g. DCACHE\_FSL\_OUT\_Data, DCACHE\_FSL\_OUT\_Control, ICACHE\_FSL\_IN\_Data, and ICACHE\_FSL\_IN\_Control)
- Information is sent (stored) by raising the write enable signal (e.g. DCACHE\_FSL\_OUT\_Write)
- The sender is only allowed to write if the full signal from the receiver is inactive (e.g. DCACHE\_FSL\_OUT\_Full = 0). The full signal is not used by the instruction cache controller.
- The use of ICACHE\_FSL\_IN\_Read and DCACHE\_FSL\_IN\_Read depends on the selected interface protocol:
  - ◆ With the IXCL and DXCL protocol, information is received (loaded) by raising the read signal. The signal is low, except when the sender signals that new data exists.
  - ◆ With the IXCL2 and DXCL2 protocol, lowering the read signal indicates that the receiver is not able to accept new data. New data is only read when the read signal is high, and the sender signals that data exists. Once a burst read has started, the read signal is not lowered.
- The receiver is only allowed to read as long as the sender signals that new data exists (e.g. ICACHE\_FSL\_IN\_Exists = 1)

For details on the generic FSL protocol, please see the *Fast Simplex Link (FSL) Bus (DS449)* data-sheet in the Xilinx EDK IP Documentation.

The CacheLink solution uses one incoming (slave) and one outgoing (master) FSL per cache controller. The outgoing FSL is used to send access requests, while the incoming FSL is used for receiving the requested cache lines. CacheLink also uses a specific encoding of the transaction information over the FSL data and control signals.

The cache lines used for reads in the CacheLink protocol are 4 or 8 words long. Each cache line is either fetched with the critical word first, or in linear order, depending on the selected interface protocol.

- Critical word first is used by the IXCL and DXCL protocol, selected when C\_ICACHE\_INTERFACE = 0 (IXCL) and C\_DCACHE\_INTERFACE = 0 (DXCL), respectively. Each cache line is expected to start with the critical word first (that is, if an access to address 0x348 is a miss with a 4 word cache line, then the returned cache line should have the following address sequence: 0x348, 0x34c, 0x340, 0x344). The cache controller forwards the first word to the execution unit as well as stores it in the cache memory. This allows execution to resume as soon as the first word is back. The cache controller then follows through by filling up the cache line with the remaining 3 or 7 words as they are received.

- Linear fetch is used by the IXCL2 and DXCL2 protocol, selected when `C_ICACHE_INTERFACE = 1` (IXCL2) and `C_DCACHE_INTERFACE = 1` (DXCL2), respectively. The address output on the CacheLink is then aligned to the cache line size (that is, if an access to address 0x348 is a miss with a 4 word cache line, then the address output on the CacheLink is 0x340). The cache controller stores data in the cache memory, and forwards the requested word to the execution unit when it is available.

When the parameter `C_DCACHE_USE_WRITEBACK` is set to 1, write operations can store an entire cache line using burst write, as well as single-words. Each cache line is always stored in linear order, and the address output on the CacheLink is aligned to the cache line size. When the parameter `C_DCACHE_USE_WRITEBACK` is cleared to 0, all write operations on the CacheLink are single-word. `C_DCACHE_INTERFACE` must be set to 1 (DXCL2) when write-back is used, since burst write is only available with the DXCL2 protocol.

## Instruction Cache Read Miss

On a read miss the cache controller performs the following sequence:

1. Write the word aligned<sup>(1)</sup> or cache line aligned missed address to `ICACHE_FSL_OUT_Data`, with the control bit set low (`ICACHE_FSL_OUT_Control = 0`) to indicate a read access
2. Wait until `ICACHE_FSL_IN_Exists` goes high to indicate that data is available

**Note:** There must be at least one clock cycle before `ICACHE_FSL_IN_Exists` goes high (that is, at least one wait state must be used).

With the IXCL protocol (critical word first):

3. Store the word from `ICACHE_FSL_IN_Data` to the cache
4. Forward the critical word to the execution unit in order to resume execution
5. Repeat 3 and 4 for the subsequent 3 or 7 words in the cache line

With the IXCL2 protocol (linear fetch):

3. Store words from `ICACHE_FSL_IN_Data` to the cache
4. Forward the relevant word to the execution unit in order to resume execution
5. Store remaining words from `ICACHE_FSL_IN_Data` to the cache

## Data Cache Read Miss

On a read miss the cache controller will perform the following sequence:

1. If `DCACHE_FSL_OUT_Full = 1` then stall until it goes low
2. Write the word aligned<sup>1</sup> or cache line aligned missed address to `DCACHE_FSL_OUT_Data`, with the control bit set low (`DCACHE_FSL_OUT_Control = 0`) to indicate a read access
3. Wait until `DCACHE_FSL_IN_Exists` goes high to indicate that data is available

**Note:** There must be at least one clock cycle before `DCACHE_FSL_IN_Exists` goes high (that is, at least one wait state must be used).

With the DXCL protocol (critical word first):

4. Store the word from `DCACHE_FSL_IN_Data` to the cache
5. Forward the critical word to the execution unit in order to resume execution
6. Repeat 4 and 5 for the subsequent 3 or 7 words in the cache line

1. Byte and halfword read misses are naturally expected to return complete words, the cache controller then provides the execution unit with the correct bytes.

With the DXCL2 protocol (linear fetch):

4. Store words from `DCACHE_FSL_IN_Data` to the cache
5. Forward the requested word to the execution unit in order to resume execution
6. Store remaining words from `DCACHE_FSL_IN_Data` to the cache

## Data Cache Write

When `C_DCACHE_INTERFACE` is set to 1 (DXCL2), the CacheLink can either do burst write or single-word write.

A burst write is used when `C_DCACHE_USE_WRITEBACK` is set to 1 and an entire cache line is valid. There are two occasions when an entire cache line becomes valid:

- If a cache miss occurs for a load instruction or byte/halfword store instruction, which causes the entire cache line to be read into the cache with a burst read.
- All words in the cache line have been written with word store instructions.

Note that writes to the data cache always are write-through when `C_DCACHE_USE_WRITEBACK` is cleared to 0, and thus there is a write over the CacheLink regardless of whether there was a hit or miss in the cache.

With the DXCL2 protocol, on a burst cache line write, the cache controller performs the following sequence:

1. If `DCACHE_FSL_OUT_Full = 1` then stall until it goes low
2. Write the cache aligned address to `DCACHE_FSL_OUT_Data`, with the control bit set high (`DCACHE_FSL_OUT_Control = 1`) to indicate a write access. The two least-significant bits (30:31) of the address are used to encode burst access: 0b10=burst. To separate a burst access from a single byte-write, the control bit for the first data word in step 4 is low for a burst access (`DCACHE_FSL_OUT_Control = 0`).
3. If `DCACHE_FSL_OUT_Full = 1` then stall until it goes low
4. Write the data to be stored to `DCACHE_FSL_OUT_Data`. The control bit is low (`DCACHE_FSL_OUT_Control = 0`) for a burst access.
5. Repeat 3 and 4 for the subsequent words in the cache line.

With either the DXCL or DXCL2 protocol, on a single-word write, the cache controller performs the following sequence:

1. If `DCACHE_FSL_OUT_Full = 1` then stall until it goes low
2. Write the missed address to `DCACHE_FSL_OUT_Data`, with the control bit set high (`DCACHE_FSL_OUT_Control = 1`) to indicate a write access. The two least-significant bits (30:31) of the address are used to encode byte and half-word enables: 0b00=byte0, 0b01=byte1 or halfword0, 0x10=byte2, and 0x11=byte3 or halfword1. The selection of half-word or byte access is based on the control bit for the data word in step 4.
3. If `DCACHE_FSL_OUT_Full = 1` then stall until it goes low
4. Write the data to be stored to `DCACHE_FSL_OUT_Data`. For byte and halfword accesses the data is mirrored onto byte-lanes. Mirroring outputs the byte or halfword to be written on all four byte-lanes or on both halfword-lanes, respectively. The control bit should be low (`DCACHE_FSL_OUT_Control = 0`) for a word or halfword access, and high for a byte access to separate it from a burst access. Word or halfword accesses can be distinguished by the least significant bit of the address (0=word and 1=halfword).

## Lockstep Interface Description

The lockstep interface on MicroBlaze is designed to connect a master and one or more slave MicroBlaze instances. The lockstep signals on MicroBlaze are listed in [Table 3-13](#).

**Table 3-13: MicroBlaze Lockstep Signals**

Signal Name	Description	VHDL Type	Direction
Lockstep_Master_Out	Output with signals going from master to slave MicroBlaze. Not connected on slaves.	std_logic	output
Lockstep_Slave_In	Input with signals coming from master to slave MicroBlaze. Not connected on master.	std_logic	input
Lockstep_Out	Output with all comparison signals from both master and slaves.	std_logic	output

The comparison signals provided by Lockstep\_Out are listed in [Table 3-14](#).

**Table 3-14: MicroBlaze Lockstep Comparison Signals**

Signal Name	Bus Index Range	VHDL Type
MB_Halted	0	std_logic
MB_Error	1	std_logic
IFetch_POS	2	std_logic
I_AS_POS	3	std_logic
Instr_Addr	4 to 35	std_logic_vector
Data_Addr	36 to 67	std_logic_vector
Data_Write	68 to 99	std_logic_vector
D_AS	100	std_logic
Read_Strobe	101	std_logic
Write_Strobe	102	std_logic
Byte_Enable	103 to 106	std_logic_vector
IPLB_M_Abort	107	std_logic
IPLB_M_busLock	108	std_logic
IPLB_M_lockErr	109	std_logic
IPLB_M_rdBurst	110	std_logic
IPLB_M_request	111	std_logic
IPLB_M_RNW	112	std_logic
IPLB_M_wrBurst	113	std_logic
IPLB_M_MSize	114 to 115	std_logic_vector
IPLB_M_priority	116 to 117	std_logic_vector
IPLB_M_ABus	118 to 149	std_logic_vector
IPLB_M_UABus	150 to 181	std_logic_vector
IPLB_M_BE <sup>1</sup>	182 to 197	std_logic_vector



**Table 3-14: MicroBlaze Lockstep Comparison Signals (Continued)**

Signal Name	Bus Index Range	VHDL Type
IPLB_M_size	198 to 201	std_logic_vector
IPLB_M_TAttribute	202 to 217	std_logic_vector
IPLB_M_type	218 to 220	std_logic_vector
IPLB_M_wrDBus <sup>1</sup>	221 to 348	std_logic_vector
DPLB_M_ABort	349	std_logic
DPLB_M_busLock	350	std_logic
DPLB_M_lockErr	351	std_logic
DPLB_M_rdBurst	352	std_logic
DPLB_M_request	353	std_logic
DPLB_M_RNW	354	std_logic
DPLB_M_wrBurst	355	std_logic
DPLB_M_ABus	356 to 387	std_logic_vector
DPLB_M_UABus	388 to 419	std_logic_vector
DPLB_M_BE <sup>1</sup>	420 to 435	std_logic_vector
DPLB_M_MSize	436 to 437	std_logic_vector
DPLB_M_priority	438 to 439	std_logic_vector
DPLB_M_size	440 to 443	std_logic_vector
DPLB_M_TAttribute	444 to 459	std_logic_vector
DPLB_M_type	460 to 462	std_logic_vector
DPLB_M_wrDBus <sup>1</sup>	463 to 590	std_logic_vector
ICACHE_FSL_IN_Clk	591	std_logic
ICACHE_FSL_IN_Read	592	std_logic
ICACHE_FSL_OUT_Clk	593	std_logic
ICACHE_FSL_OUT_Write	594	std_logic
ICACHE_FSL_OUT_Data	595 to 626	std_logic_vector
ICACHE_FSL_OUT_Control	627	std_logic
DCACHE_FSL_IN_Clk	628	std_logic
DCACHE_FSL_IN_Read	629	std_logic
DCACHE_FSL_OUT_Clk	630	std_logic
DCACHE_FSL_OUT_Write	631	std_logic
DCACHE_FSL_OUT_Data	632 to 663	std_logic_vector
DCACHE_FSL_OUT_Control	664	std_logic
M_AXI_IP_AWID	665	std_logic
M_AXI_IP_AWADDR	666 to 697	std_logic_vector
M_AXI_IP_AWLEN	698 to 705	std_logic_vector
M_AXI_IP_AWSIZE	706 to 708	std_logic_vector
M_AXI_IP_AWBURST	709 to 710	std_logic_vector
M_AXI_IP_AWLOCK	711	std_logic

Table 3-14: MicroBlaze Lockstep Comparison Signals (Continued)

Signal Name	Bus Index Range	VHDL Type
M_AXI_IP_AWCACHE	712 to 715	std_logic_vector
M_AXI_IP_AWPROT	716 to 718	std_logic_vector
M_AXI_IP_AWQOS	719 to 722	std_logic_vector
M_AXI_IP_AWVALID	723	std_logic
M_AXI_IP_WDATA	724 to 755	std_logic_vector
M_AXI_IP_WSTRB	756 to 759	std_logic_vector
M_AXI_IP_WLAST	760	std_logic
M_AXI_IP_WVALID	761	std_logic
M_AXI_IP_BREADY	762	std_logic
M_AXI_IP_ARID	763	std_logic
M_AXI_IP_ARADDR	764 to 795	std_logic_vector
M_AXI_IP_ARLEN	796 to 803	std_logic_vector
M_AXI_IP_ARSIZE	804 to 806	std_logic_vector
M_AXI_IP_ARBURST	807 to 808	std_logic_vector
M_AXI_IP_ARLOCK	809	std_logic
M_AXI_IP_ARCACHE	810 to 813	std_logic_vector
M_AXI_IP_ARPROT	814 to 816	std_logic_vector
M_AXI_IP_ARQOS	817 to 820	std_logic_vector
M_AXI_IP_ARVALID	821	std_logic
M_AXI_IP_RREADY	822	std_logic
M_AXI_DP_AWID	823	std_logic
M_AXI_DP_AWADDR	824 to 855	std_logic_vector
M_AXI_DP_AWLEN	856 to 863	std_logic_vector
M_AXI_DP_AWSIZE	864 to 866	std_logic_vector
M_AXI_DP_AWBURST	867 to 868	std_logic_vector
M_AXI_DP_AWLOCK	869	std_logic
M_AXI_DP_AWCACHE	870 to 873	std_logic_vector
M_AXI_DP_AWPROT	874 to 876	std_logic_vector
M_AXI_DP_AWQOS	877 to 880	std_logic_vector
M_AXI_DP_AWVALID	881	std_logic
M_AXI_DP_WDATA	882 to 913	std_logic_vector
M_AXI_DP_WSTRB	914 to 917	std_logic_vector
M_AXI_DP_WLAST	918	std_logic
M_AXI_DP_WVALID	919	std_logic
M_AXI_DP_BREADY	920	std_logic
M_AXI_DP_ARID	921	std_logic
M_AXI_DP_ARADDR	922 to 953	std_logic_vector
M_AXI_DP_ARLEN	954 to 961	std_logic_vector

**Table 3-14: MicroBlaze Lockstep Comparison Signals (Continued)**

Signal Name	Bus Index Range	VHDL Type
M_AXI_DP_ARSIZE	962 to 964	std_logic_vector
M_AXI_DP_ARBURST	965 to 966	std_logic_vector
M_AXI_DP_ARLOCK	967	std_logic
M_AXI_DP_ARCACHE	968 to 971	std_logic_vector
M_AXI_DP_ARPROT	972 to 974	std_logic_vector
M_AXI_DP_ARQOS	975 to 978	std_logic_vector
M_AXI_DP_ARVALID	979	std_logic
M_AXI_DP_RREADY	980	std_logic
FSLn_S_Clk	$981 + n * 37$	std_logic
FSLn_S_Read	$982 + n * 37$	std_logic
FSLn_M_Clk	$983 + n * 37$	std_logic
FSLn_M_Write	$984 + n * 37$	std_logic
FSLn_M_Data	$985 + n * 37$ to $1016 + n * 37$	std_logic_vector
FSLn_M_Control	$1017 + n * 37$	std_logic
Mn_AXIS_TLAST	$1573 + n * 35$	std_logic
Mn_AXIS_TDATA	$1574 + n * 35$ to $1606 + n * 35$	std_logic_vector
Mn_AXIS_TVALID	$1607 + n * 35$	std_logic
Sn_AXIS_TREADY	$1608 + n * 35$	std_logic
M_AXI_IC_AWID	2133	std_logic
M_AXI_IC_AWADDR	2134 to 2165	std_logic_vector
M_AXI_IC_AWLEN	2166 to 2173	std_logic_vector
M_AXI_IC_AWSIZE	2174 to 2176	std_logic_vector
M_AXI_IC_AWBURST	2177 to 2178	std_logic_vector
M_AXI_IC_AWLOCK	2179	std_logic
M_AXI_IC_AWCACHE	2180 to 2183	std_logic_vector
M_AXI_IC_AWPROT	2184 to 2186	std_logic_vector
M_AXI_IC_AWQOS	2187 to 2190	std_logic_vector
M_AXI_IC_AWVALID	2191	std_logic
M_AXI_IC_AWUSER	2192 to 2196	std_logic_vector
M_AXI_IC_AWDOMAIN <sup>2</sup>	2197 to 2198	std_logic_vector
M_AXI_IC_AWSNOOP <sup>2</sup>	2199 to 2201	std_logic_vector
M_AXI_IC_AWBAR <sup>2</sup>	2202 to 2203	std_logic_vector
M_AXI_IC_WDATA <sup>1</sup>	2204 to 2715	std_logic_vector
M_AXI_IC_WSTRB <sup>1</sup>	2716 to 2779	std_logic_vector
M_AXI_IC_WLAST	2780	std_logic
M_AXI_IC_WVALID	2781	std_logic
M_AXI_IC_WUSER	2782	std_logic
M_AXI_IC_BREADY	2783	std_logic

Table 3-14: MicroBlaze Lockstep Comparison Signals (Continued)

Signal Name	Bus Index Range	VHDL Type
M_AXI_IC_WACK	2784	std_logic
M_AXI_IC_ARID	2785	std_logic_vector
M_AXI_IC_ARADDR	2786 to 2907	std_logic_vector
M_AXI_IC_ARLEN	2818 to 2825	std_logic_vector
M_AXI_IC_ARSIZE	2826 to 2828	std_logic_vector
M_AXI_IC_ARBURST	2829 to 2830	std_logic_vector
M_AXI_IC_ARLOCK	2831	std_logic
M_AXI_IC_ARCACHE	2832 to 2835	std_logic_vector
M_AXI_IC_ARPROT	2836 to 2838	std_logic_vector
M_AXI_IC_ARQOS	2839 to 2842	std_logic_vector
M_AXI_IC_ARVALID	2843	std_logic
M_AXI_IC_ARUSER	2844 to 2848	std_logic_vector
M_AXI_IC_ARDOMAIN <sup>2</sup>	2849 to 2850	std_logic_vector
M_AXI_IC_ARSNOOP <sup>2</sup>	2851 to 2854	std_logic_vector
M_AXI_IC_ARBAR <sup>2</sup>	2855 to 2856	std_logic_vector
M_AXI_IC_RREADY	2857	std_logic
M_AXI_IC_RACK <sup>2</sup>	2858	std_logic
M_AXI_IC_ACREADY <sup>2</sup>	2859	std_logic
M_AXI_IC_CRVALID <sup>2</sup>	2860	std_logic
M_AXI_IC_CRRESP <sup>2</sup>	2861 to 2865	std_logic_vector
M_AXI_IC_CDVALID <sup>2</sup>	2866	std_logic
M_AXI_IC_CDLAST <sup>2</sup>	2867	std_logic
M_AXI_DC_AWID	2868	std_logic
M_AXI_DC_AWADDR	2869 to 2900	std_logic_vector
M_AXI_DC_AWLEN	2901 to 2908	std_logic_vector
M_AXI_DC_AWSIZE	2909 to 2911	std_logic_vector
M_AXI_DC_AWBURST	2912 to 2913	std_logic_vector
M_AXI_DC_AWLOCK	2914	std_logic
M_AXI_DC_AWCACHE	2915 to 2918	std_logic_vector
M_AXI_DC_AWPROT	2919 to 2921	std_logic_vector
M_AXI_DC_AWQOS	2922 to 2925	std_logic_vector
M_AXI_DC_AWVALID	2926	std_logic
M_AXI_DC_AWUSER	2927 to 2931	std_logic_vector
M_AXI_DC_AWDOMAIN <sup>2</sup>	2932 to 2933	std_logic_vector
M_AXI_DC_AWSNOOP <sup>2</sup>	2934 to 2936	std_logic_vector
M_AXI_DC_AWBAR <sup>2</sup>	2937 to 2938	std_logic_vector
M_AXI_DC_WDATA <sup>1</sup>	2939 to 3450	std_logic_vector
M_AXI_DC_WSTRB <sup>1</sup>	3451 to 3514	std_logic_vector

**Table 3-14: MicroBlaze Lockstep Comparison Signals (Continued)**

<b>Signal Name</b>	<b>Bus Index Range</b>	<b>VHDL Type</b>
M_AXI_DC_WLAST	3515	std_logic
M_AXI_DC_WVALID	3516	std_logic
M_AXI_DC_WUSER	3517	std_logic
M_AXI_DC_BREADY	3518	std_logic
M_AXI_DC_WACK <sup>2</sup>	3519	std_logic
M_AXI_DC_ARID	3520	std_logic
M_AXI_DC_ARADDR	3521 to 3552	std_logic_vector
M_AXI_DC_ARLEN	3553 to 3560	std_logic_vector
M_AXI_DC_ARSIZE	3561 to 3563	std_logic_vector
M_AXI_DC_ARBURST	3564 to 3565	std_logic_vector
M_AXI_DC_ARLOCK	3566	std_logic
M_AXI_DC_ARCACHE	3567 to 3570	std_logic_vector
M_AXI_DC_ARPROT	3571 to 3573	std_logic_vector
M_AXI_DC_ARQOS	3574 to 3577	std_logic_vector
M_AXI_DC_ARVALID	3578	std_logic
M_AXI_DC_ARUSER	3579 to 3583	std_logic_vector
M_AXI_DC_ARDOMAIN <sup>2</sup>	3584 to 3585	std_logic_vector
M_AXI_DC_ARSNOOP <sup>2</sup>	3586 to 3589	std_logic_vector
M_AXI_DC_ARBAR <sup>2</sup>	3590 to 3591	std_logic_vector
M_AXI_DC_RREADY	3592	std_logic
M_AXI_DC_RACK <sup>2</sup>	3593	std_logic
M_AXI_DC_ACREADY <sup>2</sup>	3594	std_logic
M_AXI_DC_CRVALID <sup>2</sup>	3595	std_logic
M_AXI_DC_CRRESP <sup>2</sup>	3596 to 3600	std_logic_vector
M_AXI_DC_CDVALID <sup>2</sup>	3601	std_logic
M_AXI_DC_CDLAST <sup>2</sup>	3602	std_logic
Trace_Instruction	3603 to 3634	std_logic_vector
Trace_Valid_Instr	3635	std_logic
Trace_PC	3636 to 3667	std_logic_vector
Trace_Reg_Write	3668	std_logic
Trace_Reg_Addr	3669 to 3673	std_logic_vector
Trace_MSR_Reg	3674 to 3688	std_logic_vector
Trace_PID_Reg	3689 to 3696	std_logic_vector
Trace_New_Reg_Value	3697 to 3728	std_logic_vector
Trace_Exception_Taken	3729	std_logic
Trace_Exception_Kind	3730 to 3734	std_logic_vector
Trace_Jump_Taken	3735	std_logic
Trace_Delay_Slot	3736	std_logic

Table 3-14: MicroBlaze Lockstep Comparison Signals (Continued)

Signal Name	Bus Index Range	VHDL Type
Trace_Data_Address	3737 to 3768	std_logic_vector
Trace_Data_Write_Value	3769 to 3800	std_logic_vector
Trace_Data_Byte_Enable	3801 to 3804	std_logic_vector
Trace_Data_Access	3805	std_logic
Trace_Data_Read	3806	std_logic
Trace_Data_Write	3807	std_logic
Trace_DCache_Req	3808	std_logic
Trace_DCache_Hit	3809	std_logic
Trace_DCache_Rdy	3810	std_logic
Trace_DCache_Read	3811	std_logic
Trace_ICache_Req	3812	std_logic
Trace_ICache_Hit	3813	std_logic
Trace_ICache_Rdy	3814	std_logic
Trace_OF_PipeRun	3815	std_logic
Trace_EX_PipeRun	3816	std_logic
Trace_MEM_PipeRun	3817	std_logic
Trace_MB_Halted	3818	std_logic
Trace_Jump_Hit	3819	std_logic
Reserved for future use	3820 to 4095	

1. This field accommodates the maximum signal width. The part used in the comparison extends from the lowest numbered bit to the actual signal width.
2. This signal is only used when C\_INTERCONNECT = 3 (ACE).

## Debug Interface Description

The debug interface on MicroBlaze is designed to work with the Xilinx Microprocessor Debug Module (MDM) IP core. The MDM is controlled by the Xilinx Microprocessor Debugger (XMD) through the JTAG port of the FPGA. The MDM can control multiple MicroBlaze processors at the same time. The debug signals are grouped in the DEBUG bus. The debug signals on MicroBlaze are listed in [Table 3-15](#).

**Table 3-15: MicroBlaze Debug Signals**

Signal Name	Description	VHDL Type	Direction
Dbg_Clk	JTAG clock from MDM	std_logic	input
Dbg_TDI	JTAG TDI from MDM	std_logic	input
Dbg_TDO	JTAG TDO to MDM	std_logic	output
Dbg_Reg_En	Debug register enable from MDM	std_logic	input
Dbg_Shift <sup>1</sup>	JTAG BSCAN shift signal from MDM	std_logic	input
Dbg_Capture	JTAG BSCAN capture signal from MDM	std_logic	input
Dbg_Update	JTAG BSCAN update signal from MDM	std_logic	input
Debug_Rst <sup>1</sup>	Reset signal from MDM, active high. Should be held for at least 1 Clk clock cycle.	std_logic	input

1. Updated for MicroBlaze v7.00: Dbg\_Shift added and Debug\_Rst included in DEBUG bus

## Trace Interface Description

The MicroBlaze core exports a number of internal signals for trace purposes. This signal interface is not standardized and new revisions of the processor may not be backward compatible for signal selection or functionality. It is recommended that you not design custom logic for these signals, but rather to use them via Xilinx provided analysis IP. The trace signals are grouped in the TRACE bus. The current set of trace signals were last updated for MicroBlaze v7.30 and are listed in [Table 3-16](#). The Trace exception types are listed in [Table 3-17](#). All unused Trace exception types are reserved.

**Table 3-16: MicroBlaze Trace Signals**

Signal Name	Description	VHDL Type	Direction
Trace_Valid_Instr	Valid instruction on trace port.	std_logic	output
Trace_Instruction <sup>1</sup>	Instruction code	std_logic_vector (0 to 31)	output
Trace_PC <sup>1</sup>	Program counter	std_logic_vector (0 to 31)	output
Trace_Reg_Write <sup>1</sup>	Instruction writes to the register file	std_logic	output
Trace_Reg_Addr <sup>1</sup>	Destination register address	std_logic_vector (0 to 4)	output
Trace_MSR_Reg <sup>1</sup>	Machine status register	std_logic_vector (0 to 14) <sup>2</sup>	output
Trace_PID_Reg <sup>1,2</sup>	Process identifier register	std_logic_vector (0 to 7)	output

Table 3-16: MicroBlaze Trace Signals (Continued)

Signal Name	Description	VHDL Type	Direction
Trace_New_Reg_Value <sup>1</sup>	Destination register update value	std_logic_vector (0 to 31)	output
Trace_Exception_Taken <sup>1</sup>	Instruction result in taken exception	std_logic	output
Trace_Exception_Kind <sup>1,3</sup>	Exception type. The description for the exception type is documented below.	std_logic_vector (0 to 4) <sup>2</sup>	output
Trace_Jump_Taken <sup>1</sup>	Branch instruction evaluated true, i.e taken	std_logic	output
Trace_Jump_Hit <sup>1,4,6</sup>	Branch Target Cache hit	std_logic	output
Trace_Delay_Slot <sup>1</sup>	Instruction is in delay slot of a taken branch	std_logic	output
Trace_Data_Access <sup>1</sup>	Valid D-side memory access	std_logic	output
Trace_Data_Address <sup>1</sup>	Address for D-side memory access	std_logic_vector (0 to 31)	output
Trace_Data_Write_Value <sup>1</sup>	Value for D-side memory write access	std_logic_vector (0 to 31)	output
Trace_Data_Byte_Enable <sup>1</sup>	Byte enables for D-side memory access	std_logic_vector (0 to 3)	output
Trace_Data_Read <sup>1</sup>	D-side memory access is a read	std_logic	output
Trace_Data_Write <sup>1</sup>	D-side memory access is a write	std_logic	output
Trace_DCache_Req	Data memory address is within D-Cache range	std_logic	output
Trace_DCache_Hit	Data memory address is present in D-Cache	std_logic	output
Trace_DCache_Rdy	Data memory address is within D-Cache range and the access is completed	std_logic	output
Trace_DCache_Read <sup>5</sup>	The D-Cache request is a read	std_logic	output
Trace_ICache_Req	Instruction memory address is within I-Cache range	std_logic	output
Trace_ICache_Hit	Instruction memory address is present in I-Cache	std_logic	output
Trace_ICache_Rdy	Instruction memory address is within I-Cache range and the access is completed	std_logic	output
Trace_OF_PipeRun	Pipeline advance for Decode stage	std_logic	output
Trace_EX_PipeRun <sup>6</sup>	Pipeline advance for Execution stage	std_logic	output
Trace_MEM_PipeRun <sup>6</sup>	Pipeline advance for Memory stage	std_logic	output
Trace_MB_Halted <sup>2</sup>	Pipeline is halted by debug	std_logic	output

1. Valid only when Trace\_Valid\_Instr = 1

2. Updated for MicroBlaze v7.00: 4 bits added to Trace\_MSR\_Reg, Trace\_PID\_Reg added, Trace\_MB\_Halted added, and 1 bit added to Trace\_Exception Kind

3. Valid only when Trace\_Exception\_Taken = 1

4. Updated for MicroBlaze v7.30: Trace\_DCache\_Rdy, Trace\_DCache\_Read, Trace\_ICache\_Rdy, and Trace\_Jump\_Hit added

5. Valid only when Trace\_DCache\_Req = 1

6. Not used with area optimization feature



Table 3-17: Type of Trace Exception

Trace_Exception_Kind [0:4]	Description
00000	Stream exception <sup>1</sup>
00001	Unaligned exception
00010	Illegal Opcode exception
00011	Instruction Bus exception
00100	Data Bus exception
00101	Divide exception
00110	FPU exception
00111	Privileged instruction exception <sup>1</sup>
01010	Interrupt
01011	External non maskable break
01100	External maskable break
10000	Data storage exception <sup>1</sup>
10001	Instruction storage exception <sup>1</sup>
10010	Data TLB miss exception <sup>1</sup>
10011	Instruction TLB miss exception <sup>1</sup>

1. Added for MicroBlaze v7.00

## MicroBlaze Core Configurability

The MicroBlaze core has been developed to support a high degree of user configurability. This allows tailoring of the processor to meet specific cost/performance requirements.

Configuration is done via parameters that typically enable, size, or select certain processor features. For example, the instruction cache is enabled by setting the `C_USE_ICACHE` parameter. The size of the instruction cache, and the cacheable memory range, are all configurable using: `C_CACHE_BYTE_SIZE`, `C_ICACHE_BASEADDR`, and `C_ICACHE_HIGHADDR` respectively.

Parameters valid for MicroBlaze v8.00 are listed in [Table 3-18](#). Not all of these are recognized by older versions of MicroBlaze; however, the configurability is fully backward compatibility.

**Note:** Shaded rows indicate that the parameter has a fixed value and *cannot* be modified.

Table 3-18: MPD Parameters

Parameter Name	Feature/Description	Allowable Values	Default Value	EDK Tool Assigned	VHDL Type
<code>C_FAMILY</code>	Target Family	Listed in <a href="#">Table 3-19</a>	virtex5	yes	string
<code>C_DATA_SIZE</code>	Data Size	32	32	NA	integer
<code>C_DYNAMIC_BUS_SIZING</code>	Legacy	1	1	NA	integer
<code>C_SCO</code>	Xilinx internal	0	0	NA	integer
<code>C_AREA_OPTIMIZED</code>	Select implementation to optimize area with lower instruction throughput	0, 1	0		integer
<code>C_OPTIMIZATION</code>	Reserved for future use	0	0	NA	integer
<code>C_INTERCONNECT</code>	Select interconnect 1 = PLBv46 2 = AXI4 only 3 = AXI4 and ACE	1, 2, 3	1		integer
<code>C_ENDIANNES</code>	Select endianness 0 = Big Endian 1 = Little Endian	0, 1	0	yes	integer
<code>C_BASE_VECTORS</code> <sup>1</sup>	Configurable base vectors	0x00000000-0xfffff80	0x00000000		std_logic_vector
<code>C_FAULT_TOLERANT</code>	Implement fault tolerance	0, 1	0		integer
<code>C_ECC_USE_CE_EXCEPTION</code>	Generate exception for correctible ECC error	0,1	0		integer
<code>C_LOCKSTEP_SLAVE</code>	Lockstep Slave	0, 1	0		integer

**Table 3-18: MPD Parameters (Continued)**

Parameter Name	Feature/Description	Allowable Values	Default Value	EDK Tool Assigned	VHDL Type
C_AVOID_PRIMITIVES	Disallow FPGA primitives 0 = None 1 = SRL 2 = LUTRAM 3 = Both	0, 1, 2, 3	0		integer
C_PVR	Processor version register mode selection 0 = None 1 = Basic 2 = Full	0, 1, 2	0		integer
C_PVR_USER1	Processor version register USER1 constant	0x00-0xff	0x00		std_logic_vector (0 to 7)
C_PVR_USER2	Processor version register USER2 constant	0x00000000-0xffffffff	0x00000000		std_logic_vector (0 to 31)
C_RESET_MSR	Reset value for MSR register	0x00, 0x20, 0x80, 0xa0	0x00		std_logic_vector
C_INSTANCE	Instance Name	Any instance name	microblaze	yes	string
C_D_PLB	Data side PLB interface	0, 1	0	yes	integer
C_D_AXI	Data side AXI interface	0, 1	0	yes	integer
C_D_LMB	Data side LMB interface	0, 1	1	yes	integer
C_I_PLB	Instruction side PLB interface	0, 1	0	yes	integer
C_I_AXI	Instruction side AXI interface	0, 1	0	yes	integer
C_I_LMB	Instruction side LMB interface	0, 1	1	yes	integer
C_USE_BARREL	Include barrel shifter	0, 1	0		integer
C_USE_DIV	Include hardware divider	0, 1	0		integer
C_USE_HW_MUL	Include hardware multiplier 0 = None 1 = Mul32 2 = Mul64	0, 1, 2	1		integer

Table 3-18: MPD Parameters (Continued)

Parameter Name	Feature/Description	Allowable Values	Default Value	EDK Tool Assigned	VHDL Type
C_USE_FPU	Include hardware floating point unit 0 = None 1 = Basic 2 = Extended	0, 1, 2	0		integer
C_USE_MSR_INSTR	Enable use of instructions: MSRSET and MSRCLR	0, 1	1		integer
C_USE_PCOMP_INSTR	Enable use of instructions: CLZ, PCMPBF, PCMPEQ, and PCMPNE	0, 1	1		integer
C_USE_REORDER_INSTR	Enable use of instructions: Reverse load, reverse store, and swap	0, 1	1		integer
C_UNALIGNED_EXCEPTIONS	Enable exception handling for unaligned data accesses	0, 1	0		integer
C_ILL_OPCODE_EXCEPTION	Enable exception handling for illegal op-code	0, 1	0		integer
C_IPLB_BUS_EXCEPTION	Enable exception handling for IPLB bus error	0, 1	0		integer
C_DPLB_BUS_EXCEPTION	Enable exception handling for DPLB bus error	0, 1	0		integer
C_M_AXI_I_BUS_EXCEPTION	Enable exception handling for M_AXI_I bus error	0, 1	0		integer
C_M_AXI_D_BUS_EXCEPTION	Enable exception handling for M_AXI_D bus error	0, 1	0		integer
C_DIV_ZERO_EXCEPTION	Enable exception handling for division by zero or division overflow	0, 1	0		integer
C_FPU_EXCEPTION	Enable exception handling for hardware floating point unit exceptions	0, 1	0		integer
C_OPCODE_0x0_ILLEGAL	Detect opcode 0x0 as an illegal instruction	0,1	0		integer
C_FSL_EXCEPTION	Enable exception handling for Stream Links	0,1	0		integer

**Table 3-18: MPD Parameters (Continued)**

Parameter Name	Feature/Description	Allowable Values	Default Value	EDK Tool Assigned	VHDL Type
C_ECC_USE_CE_EXCEPTION	Generate Bus Error Exceptions for correctable errors	0,1	0		integer
C_USE_STACK_PROTECTION	Generate exception for stack overflow or stack underflow	0,1	0		integer
C_DEBUG_ENABLED	MDM Debug interface	0,1	0		integer
C_NUMBER_OF_PC_BRK	Number of hardware breakpoints	0-8	1		integer
C_NUMBER_OF_RD_ADDR_BRK	Number of read address watchpoints	0-4	0		integer
C_NUMBER_OF_WR_ADDR_BRK	Number of write address watchpoints	0-4	0		integer
C_INTERRUPT_IS_EDGE	Level/Edge Interrupt	0, 1	0	yes	integer
C_EDGE_IS_POSITIVE	Negative/Positive Edge Interrupt	0, 1	1	yes	integer
C_FSL_LINKS <sup>2</sup>	Number of stream interfaces (FSL or AXI)	0-16	0	yes	integer
C_FSL_DATA_SIZE	FSL data bus size	32	32	NA	integer
C_USE_EXTENDED_FSL_INSTR	Enable use of extended stream instructions	0, 1	0		integer
C_ICACHE_BASEADDR	Instruction cache base address	0x00000000 - 0xFFFFFFFF	0x00000000		std_logic_vector
C_ICACHE_HIGHADDR	Instruction cache high address	0x00000000 - 0xFFFFFFFF	0x3FFF FFFF		std_logic_vector
C_USE_ICACHE	Instruction cache	0, 1	0		integer
C_ALLOW_ICACHE_WR	Instruction cache write enable	0, 1	1		integer
C_ICACHE_LINE_LEN	Instruction cache line length	4, 8	4		integer

Table 3-18: MPD Parameters (Continued)

Parameter Name	Feature/Description	Allowable Values	Default Value	EDK Tool Assigned	VHDL Type
C_ICACHE_ALWAYS_USED	Instruction cache interface used for all memory accesses in the cacheable range	0, 1	0		integer
C_ICACHE_INTERFACE	Instruction cache CacheLink interface protocol 0 = IXCL 1 = IXCL2	0, 1	0	yes <sup>3</sup>	integer
C_ICACHE_FORCE_TAG_LUTRAM	Instruction cache tag always implemented with distributed RAM	0, 1	0		integer
C_ICACHE_STREAMS	Instruction cache streams	0, 1	0		integer
C_ICACHE_VICTIMS	Instruction cache victims	0, 2, 4, 8	0		integer
C_ICACHE_DATA_WIDTH	Instruction cache data width 0 = 32 bits 1 = Full cache line 2 = 512 bits	0, 1, 2	0		integer
C_ADDR_TAG_BITS	Instruction cache address tags	0-25	17	yes	integer
C_CACHE_BYTE_SIZE	Instruction cache size	64, 128, 256, 512, 1024, 2048, 4096, 8192, 16384, 32768, 65536 <sup>4</sup>	8192		integer
C_ICACHE_USE_FSL	Cache over CacheLink instead of peripheral bus for instructions	1	1		integer
C_DCACHE_BASEADDR	Data cache base address	0x00000000 - 0xFFFFFFFF	0x00000000		std_logic_vector
C_DCACHE_HIGHADDR	Data cache high address	0x00000000 - 0xFFFFFFFF	0x3FFF FFFF		std_logic_vector
C_USE_DCACHE	Data cache	0, 1	0		integer
C_ALLOW_DCACHE_WR	Data cache write enable	0, 1	1		integer

**Table 3-18: MPD Parameters (Continued)**

Parameter Name	Feature/Description	Allowable Values	Default Value	EDK Tool Assigned	VHDL Type
C_DCACHE_LINE_LEN	Data cache line length	4, 8	4		integer
C_DCACHE_ALWAYS_USED	Data cache interface used for all accesses in the cacheable range	0, 1	0		integer
C_DCACHE_INTERFACE	Data cache CacheLink interface protocol 0 = DXCL 1 = DXCL2	0, 1	0	yes <sup>3</sup>	integer
C_DCACHE_FORCE_TAG_LUTRAM	Data cache tag always implemented with distributed RAM	0, 1	0		integer
C_DCACHE_USE_WRITEBACK	Data cache write-back storage policy used	0, 1	0		integer
C_DCACHE_VICTIMS	Data cache victims	0, 2, 4, 8	0		integer
C_DCACHE_DATA_WIDTH	Data cache data width 0 = 32 bits 1 = Full cache line 2 = 512 bits	0, 1, 2	0		integer
C_DCACHE_ADDR_TAG	Data cache address tags	0-25	17	yes	integer
C_DCACHE_BYTE_SIZE	Data cache size	64, 128, 256, 512, 1024, 2048, 4096, 8192, 16384, 32768, 65536 <sup>4</sup>	8192		integer
C_DCACHE_USE_FSL	Cache over CacheLink instead of peripheral bus for data	1	1		integer
C_DPLB_DWIDTH	Data side PLB data width	32	32		integer
C_DPLB_NATIVE_DWIDTH	Data side PLB native data width	32	32		integer
C_DPLB_BURST_EN	Data side PLB burst enable	0	0		integer
C_DPLB_P2P	Data side PLB Point-to-point	0, 1	0		integer

Table 3-18: MPD Parameters (Continued)

Parameter Name	Feature/Description	Allowable Values	Default Value	EDK Tool Assigned	VHDL Type
C_IPLB_DWIDTH	Instruction side PLB data width	32	32		integer
C_IPLB_NATIVE_DWIDTH	Instruction side PLB native data width	32	32		integer
C_IPLB_BURST_EN	Instruction side PLB burst enable	0	0		integer
C_IPLB_P2P	Instruction side PLB Point-to-point	0, 1	0		integer
C_USE_MMU <sup>5</sup>	Memory Management: 0 = None 1 = User Mode 2 = Protection 3 = Virtual	0, 1, 2, 3	0		integer
C_MMU_DTLB_SIZE <sup>5</sup>	Data shadow Translation Look-Aside Buffer size	1, 2, 4, 8	4		integer
C_MMU_ITLB_SIZE <sup>5</sup>	Instruction shadow Translation Look-Aside Buffer size	1, 2, 4, 8	2		integer
C_MMU_TLB_ACCESS <sup>5</sup>	Access to memory management special registers: 0 = Minimal 1 = Read 2 = Write 3 = Full	0, 1, 2, 3	3		integer
C_MMU_ZONES <sup>5</sup>	Number of memory protection zones	0-16	16		integer
C_MMU_PRIVILEGED_INSTR <sup>5</sup>	Privileged instructions 0 = Full protection 1 = Allow stream instrs	0,1	0		integer
C_USE_INTERRUPT	Enable interrupt handling 0 = No interrupt 1 = Standard interrupt 2 = Low-latency interrupt	0, 1, 2	0	yes	integer
C_USE_EXT_BRK	Enable external break handling	0,1	0	yes	integer



**Table 3-18: MPD Parameters (Continued)**

Parameter Name	Feature/Description	Allowable Values	Default Value	EDK Tool Assigned	VHDL Type
C_USE_EXT_NM_BRK	Enable external non-maskable break handling	0,1	0	yes	integer
C_USE_BRANCH_TARGET_CACHE <sup>5</sup>	Enable Branch Target Cache	0,1	0		integer
C_BRANCH_TARGET_CACHE_SIZE <sup>5</sup>	Branch Target Cache size: 0 = Default 1 = 8 entries 2 = 16 entries 3 = 32 entries 4 = 64 entries 5 = 512 entries 6 = 1024 entries 7 = 2048 entries	0-7	0		integer
C_M_AXI_DP_THREAD_ID_WIDTH	Data side AXI thread ID width	1	1		integer
C_M_AXI_DP_DATA_WIDTH	Data side AXI data width	32	32		integer
C_M_AXI_DP_ADDR_WIDTH	Data side AXI address width	32	32		integer
C_M_AXI_DP_SUPPORTS_THREADS	Data side AXI uses threads	0	0		integer
C_M_AXI_DP_SUPPORTS_READ	Data side AXI support for read accesses	1	1		integer
C_M_AXI_DP_SUPPORTS_WRITE	Data side AXI support for write accesses	1	1		integer
C_M_AXI_DP_SUPPORTS_NARROW_BURST	Data side AXI narrow burst support	0	0		integer
C_M_AXI_DP_PROTOCOL	Data side AXI protocol	AXI4, AXI4LITE	AXI4 LITE	yes	string
C_M_AXI_DP_EXCLUSIVE_ACCESS	Data side AXI exclusive access support	0,1	0		integer
C_INTERCONNECT_M_AXI_DP_READ_ISSUING	Data side AXI read accesses issued	1	1		integer
C_INTERCONNECT_M_AXI_DP_WRITE_ISSUING	Data side AXI write accesses issued	1	1		integer

Table 3-18: MPD Parameters (Continued)

Parameter Name	Feature/Description	Allowable Values	Default Value	EDK Tool Assigned	VHDL Type
C_M_AXI_IP_THREAD_ID_WIDTH	Instruction side AXI thread ID width	1	1		integer
C_M_AXI_IP_DATA_WIDTH	Instruction side AXI data width	32	32		integer
C_M_AXI_IP_ADDR_WIDTH	Instruction side AXI address width	32	32		integer
C_M_AXI_IP_SUPPORTS_THREADS	Instruction side AXI uses threads	0	0		integer
C_M_AXI_IP_SUPPORTS_READ	Instruction side AXI support for read accesses	1	1		integer
C_M_AXI_IP_SUPPORTS_WRITE	Instruction side AXI support for write accesses	0	0		integer
C_M_AXI_IP_SUPPORTS_NARROW_BURST	Instruction side AXI narrow burst support	0	0		integer
C_M_AXI_IP_PROTOCOL	Instruction side AXI protocol	AXI4LITE	AXI4LITE		string
C_INTERCONNECT_M_AXI_IP_READ_ISSUING	Instruction side AXI read accesses issued	1	1		integer
C_M_AXI_DC_THREAD_ID_WIDTH	Data cache AXI ID width	1	1		integer
C_M_AXI_DC_DATA_WIDTH	Data cache AXI data width	32, 64, 128, 256, 512	32		integer
C_M_AXI_DC_ADDR_WIDTH	Data cache AXI address width	32	32		integer
C_M_AXI_DC_SUPPORTS_THREADS	Data cache AXI uses threads	0	0		integer
C_M_AXI_DC_SUPPORTS_READ	Data cache AXI support for read accesses	1	1		integer
C_M_AXI_DC_SUPPORTS_WRITE	Data cache AXI support for write accesses	1	1		integer
C_M_AXI_DC_SUPPORTS_NARROW_BURST	Data cache AXI narrow burst support	0	0		integer

**Table 3-18: MPD Parameters (Continued)**

Parameter Name	Feature/Description	Allowable Values	Default Value	EDK Tool Assigned	VHDL Type
C_M_AXI_DC_SUPPORTS_USER_SIGNALS	Data cache AXI user signal support	1	1		integer
C_M_AXI_DC_PROTOCOL	Data cache AXI protocol	AXI4	AXI4		string
C_M_AXI_DC_AWUSER_WIDTH	Data cache AXI user width	5	5		integer
C_M_AXI_DC_ARUSER_WIDTH	Data cache AXI user width	5	5		integer
C_M_AXI_DC_WUSER_WIDTH	Data cache AXI user width	1	1		integer
C_M_AXI_DC_RUSER_WIDTH	Data cache AXI user width	1	1		integer
C_M_AXI_DC_BUSER_WIDTH	Data cache AXI user width	1	1		integer
C_M_AXI_DC_EXCLUSIVE_ACCESS	Data cache AXI exclusive access support	0,1	0		integer
C_M_AXI_DC_USER_VALUE	Data cache AXI user value	0-31	31		integer
C_INTERCONNECT_M_AXI_DC_READ_ISSUING	Data cache AXI read accesses issued	1,2	2		integer
C_INTERCONNECT_M_AXI_DC_WRITE_ISSUING	Data cache AXI write accesses issued	1,2,4,8,16,32	32		integer
C_M_AXI_IC_THREAD_ID_WIDTH	Instruction cache AXI ID width	1	1		integer
C_M_AXI_IC_DATA_WIDTH	Instruction cache AXI data width	32, 64, 128, 256, 512	32		integer
C_M_AXI_IC_ADDR_WIDTH	Instruction cache AXI address width	32	32		integer
C_M_AXI_IC_SUPPORTS_THREADS	Instruction cache AXI uses threads	0	0		integer
C_M_AXI_IC_SUPPORTS_READ	Instruction cache AXI support for read accesses	1	1		integer
C_M_AXI_IC_SUPPORTS_WRITE	Instruction cache AXI support for write accesses	0	0		integer
C_M_AXI_IC_SUPPORTS_NARROW_BURST	Instruction cache AXI narrow burst support	0	0		integer
C_M_AXI_IC_SUPPORTS_USER_SIGNALS	Instruction cache AXI user signal support	1	1		integer

Table 3-18: MPD Parameters (Continued)

Parameter Name	Feature/Description	Allowable Values	Default Value	EDK Tool Assigned	VHDL Type
C_M_AXI_IC_PROTOCOL	Instruction cache AXI protocol	AXI4	AXI4		string
C_M_AXI_IC_AWUSER_WIDTH	Instruction cache AXI user width	5	5		integer
C_M_AXI_IC_ARUSER_WIDTH	Instruction cache AXI user width	5	5		integer
C_M_AXI_IC_WUSER_WIDTH	Instruction cache AXI user width	1	1		integer
C_M_AXI_IC_RUSER_WIDTH	Instruction cache AXI user width	1	1		integer
C_M_AXI_IC_BUSER_WIDTH	Instruction cache AXI user width	1	1		integer
C_M_AXI_IC_USER_VALUE	Instruction cache AXI user value	0-31	31		integer
C_INTERCONNECT_M_AXI_IC_READ_ISSUING	Instruction cache AXI read accesses issued	1,2,4,8	2	yes	integer
C_STREAM_INTERCONNECT	Select AXI4-Stream interconnect	0,1	0		integer
C_Mn_AXIS_PROTOCOL	AXI4-Stream protocol	GENERIC	GENERIC		string
C_Sn_AXIS_PROTOCOL	AXI4-Stream protocol	GENERIC	GENERIC		string
C_Mn_AXIS_DATA_WIDTH	AXI4-Stream master data width	32	32	NA	integer
C_Sn_AXIS_DATA_WIDTH	AXI4-Stream slave data width	32	32	NA	integer

1. The 7 least significant bits must all be 0.
2. The number of Stream Links (FSL or AXI4) is assigned by the tool itself if you are using the co-processor wizard. If you add the IP manually, you must update the parameter manually.
3. EDK tool assigned value can be overridden by explicit assignment.
4. Not all sizes are permitted in all architectures. The cache uses between 0 and 32 RAMB primitives (0 if cache size is less than 2048).
5. Not available when C\_AREA\_OPTIMIZED is set to 1.

Table 3-19: Parameter C\_FAMILY Allowable Values

	Allowable Values
Artix	aartix7 artix7 artix7l qartix7 qartix7l
Kintex	kintex7 kintex7l qkintex7 qkintex7l
Spartan	aspartan3 aspartan3a aspartan3adsp aspartan3e aspartan6 qspartan6 qspartan6l spartan3 spartan3a spartan3adsp spartan3an spartan3e spartan6 spartan6l
Virtex	qrvirtex4 qrvirtex5 qvirtex4 qvirtex5 qvirtex6 qvirtex7 virtex4 virtex5 virtex6 virtex6l virtex7
Zynq	azynq zynq qzynq



## MicroBlaze Application Binary Interface

---

This chapter describes MicroBlaze™ Application Binary Interface (ABI), which is important for developing software in assembly language for the soft processor. The MicroBlaze GNU compiler follows the conventions described in this document. Any code written by assembly programmers should also follow the same conventions to be compatible with the compiler generated code. Interrupt and Exception handling is also explained briefly.

### Data Types

The data types used by MicroBlaze assembly programs are shown in [Table 4-1](#). Data types such as data8, data16, and data32 are used in place of the usual byte, half-word, and word.register

**Table 4-1: Data Types in MicroBlaze Assembly Programs**

MicroBlaze data types (for assembly programs)	Corresponding ANSI C data types	Size (bytes)
data8	char	1
data16	short	2
data32	int	4
data32	long int	4
data32	float	4
data32	enum	4
data16/data32	pointer <sup>1</sup>	2/4

1. Pointers to small data areas, which can be accessed by global pointers are data16.

## Register Usage Conventions

The register usage convention for MicroBlaze is given in [Table 4-2](#).

**Table 4-2: Register Usage Conventions**

Register	Type	Enforcement	Purpose
R0	Dedicated	HW	Value 0
R1	Dedicated	SW	Stack Pointer
R2	Dedicated	SW	Read-only small data area anchor
R3-R4	Volatile	SW	Return Values/Temporaries
R5-R10	Volatile	SW	Passing parameters/Temporaries
R11-R12	Volatile	SW	Temporaries
R13	Dedicated	SW	Read-write small data area anchor
R14	Dedicated	HW	Return address for Interrupt
R15	Dedicated	SW	Return address for Sub-routine
R16	Dedicated	HW	Return address for Trap (Debugger)
R17	Dedicated	HW/SW	Return address for Exceptions HW if configured to support hardware exceptions, else SW
R18	Dedicated	SW	Reserved for Assembler/Compiler Temporaries Used for Service ID with attribute svc_table_handler
R19	Non-volatile	SW	Must be saved across function calls. Callee-save
R20	Dedicated or Non-volatile	SW	Reserved for storing a pointer to the Global Offset Table (GOT) in Position Independent Code (PIC). Non-volatile in non-PIC code. Must be saved across function calls. Callee-save
R21-R31	Non-volatile	SW	Must be saved across function calls. Callee-save
RPC	Special	HW	Program counter
RMSR	Special	HW	Machine Status Register
REAR	Special	HW	Exception Address Register
RESR	Special	HW	Exception Status Register
RFSR	Special	HW	Floating Point Status Register
RBTR	Special	HW	Branch Target Register
REDR	Special	HW	Exception Data Register
RPID	Special	HW	Process Identifier Register
RZPR	Special	HW	Zone Protection Register
RTLBlo	Special	HW	Translation Look-Aside Buffer Low Register
RTLbHi	Special	HW	Translation Look-Aside Buffer High Register
RTLbX	Special	HW	Translation Look-Aside Buffer Index Register
RTLbSX	Special	HW	Translation Look-Aside Buffer Search Index
RPVR0- RPVR12	Special	HW	Processor Version Register 0 through 12



The architecture for MicroBlaze defines 32 general purpose registers (GPRs). These registers are classified as volatile, non-volatile, and dedicated.

- The volatile registers (also known as caller-save) are used as temporaries and do not retain values across the function calls. Registers R3 through R12 are volatile, of which R3 and R4 are used for returning values to the caller function, if any. Registers R5 through R10 are used for passing parameters between subroutines.
- Registers R19 through R31 retain their contents across function calls and are hence termed as non-volatile registers (a.k.a callee-save). The callee function is expected to save those non-volatile registers, which are being used. These are typically saved to the stack during the prologue and then reloaded during the epilogue.
- Certain registers are used as dedicated registers and programmers are not expected to use them for any other purpose.
  - ◆ Registers R14 through R17 are used for storing the return address from interrupts, subroutines, traps, and exceptions in that order. Subroutines are called using the branch and link instruction, which saves the current Program Counter (PC) onto register R15.
  - ◆ Small data area pointers are used for accessing certain memory locations with 16-bit immediate value. These areas are discussed in the memory model section of this document. The read only small data area (SDA) anchor R2 (Read-Only) is used to access the constants such as literals. The other SDA anchor R13 (Read-Write) is used for accessing the values in the small data read-write section.
  - ◆ Register R1 stores the value of the stack pointer and is updated on entry and exit from functions.
  - ◆ Register R18 is used as a temporary register for assembler operations.
- MicroBlaze includes special purpose registers such as: program counter (rpc), machine status register (rmsr), exception status register (resr), exception address register (rear), floating point status register (rfsr), branch target register (rbtr), exception data register (redr), memory management registers (rpid, rzpr, rtlblo, rtlbhi, rtlbx, rtlbsx), and processor version registers (rpvr0-rpvr12). These registers are not mapped directly to the register file and hence the usage of these registers is different from the general purpose registers. The value of a special purpose registers can be transferred to or from a general purpose register by using `mts` and `mfs` instructions respectively.

## Stack Convention

The stack conventions used by MicroBlaze are detailed in [Table 4-3](#).

The shaded area in [Table 4-3](#) denotes a part of the stack frame for a caller function, while the unshaded area indicates the callee frame function. The ABI conventions of the stack frame define the protocol for passing parameters, preserving non-volatile register values, and allocating space for the local variables in a function.

Functions that contain calls to other subroutines are called as non-leaf functions. These non-leaf functions have to create a new stack frame area for its own use. When the program starts executing, the stack pointer has the maximum value. As functions are called, the stack pointer is decremented by the number of words required by every function for its stack frame. The stack pointer of a caller function always has a higher value as compared to the callee function.

Table 4-3: Stack Convention

High Address	
	Function Parameters for called sub-routine (Arg n .. Arg1) (Optional: Maximum number of arguments required for any called procedure from the current procedure).
Old Stack Pointer	Link Register (R15)
	Callee Saved Register (R31....R19) (Optional: Only those registers which are used by the current procedure are saved)
	Local Variables for Current Procedure (Optional: Present only if Locals defined in the procedure)
	Functional Parameters (Arg n .. Arg 1) (Optional: Maximum number of arguments required for any called procedure from the current procedure)
New Stack Pointer	Link Register
Low Address	

Consider an example where Func1 calls Func2, which in turn calls Func3. The stack representation at different instances is depicted in Figure 4-1. After the call from Func 1 to Func 2, the value of the stack pointer (SP) is decremented. This value of SP is again decremented to accommodate the stack frame for Func3. On return from Func 3 the value of the stack pointer is increased to its original value in the function, Func 2.

Details of how the stack is maintained are shown in Figure 4-1.

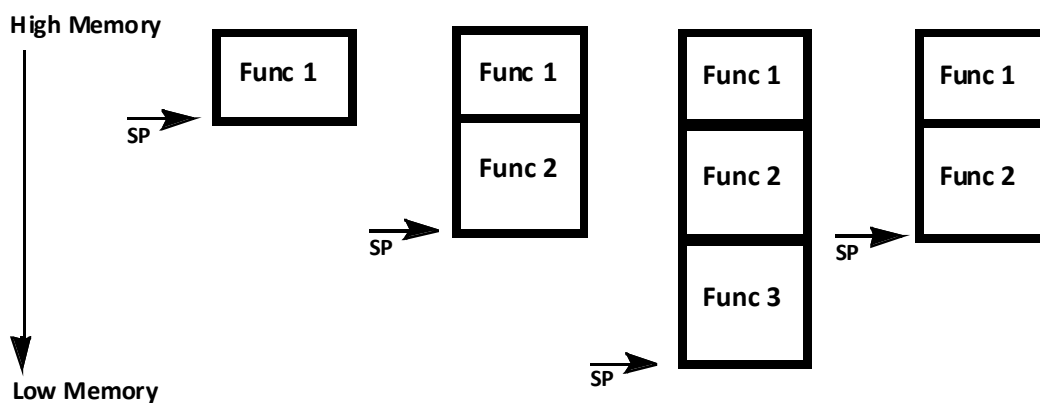

Figure 4-1: Stack Frame

## Calling Convention

The caller function passes parameters to the callee function using either the registers (R5 through R10) or on its own stack frame. The callee uses the stack area of the caller to store the parameters passed to the callee.

Refer to [Figure 4-1](#). The parameters for Func 2 are stored either in the registers R5 through R10 or on the stack frame allocated for Func 1.

If Func 2 has more than six integer parameters, the first six parameters can be passed in registers R5 through R10, whereas all subsequent parameters must be passed on the stack frame allocated for Func 1, starting at offset SP + 28.

## Memory Model

The memory model for MicroBlaze classifies the data into four different parts: Small Data Area, Data Area, Common Un-Initialized Area, and Literals or Constants.

### Small Data Area

Global initialized variables which are small in size are stored in this area. The threshold for deciding the size of the variable to be stored in the small data area is set to 8 bytes in the MicroBlaze C compiler (mb-gcc), but this can be changed by giving a command line option to the compiler. Details about this option are discussed in the *GNU Compiler Tools* chapter. 64 kilobytes of memory is allocated for the small data areas. The small data area is accessed using the read-write small data area anchor (R13) and a 16-bit offset. Allocating small variables to this area reduces the requirement of adding **IMM** instructions to the code for accessing global variables. Any variable in the small data area can also be accessed using an absolute address.

### Data Area

Comparatively large initialized variables are allocated to the data area, which can either be accessed using the read-write SDA anchor R13 or using the absolute address, depending on the command line option given to the compiler.

### Common Un-Initialized Area

Un-initialized global variables are allocated in the common area and can be accessed either using the absolute address or using the read-write small data area anchor R13.

### Literals or Constants

Constants are placed into the read-only small data area and are accessed using the read-only small data area anchor R2.

The compiler generates appropriate global pointers to act as base pointers. The actual values of the SDA anchors are decided by the linker, in the final linking stages. For more information on the various sections of the memory please refer to *MicroBlaze Linker Script Sections* in the *Embedded System Tools Reference Manual*. The compiler generates appropriate sections, depending on the command line options. Please refer to the *GNU Compiler Tools* chapter in the *Embedded System Tools Reference Manual* for more information about these options.

## Interrupt and Exception Handling

MicroBlaze assumes certain address locations for handling interrupts and exceptions as indicated in Table 4-4. At these locations, code is written to jump to the appropriate handlers.

Table 4-4: Interrupt and Exception Handling

On	Hardware jumps to	Software Labels
Start / Reset	C_BASE_VECTORS + 0x0	_start
User exception	C_BASE_VECTORS + 0x8	_exception_handler
Interrupt	C_BASE_VECTORS + 0x10 <sup>1</sup>	_interrupt_handler
Break (HW/SW)	C_BASE_VECTORS + 0x18	-
Hardware exception	C_BASE_VECTORS + 0x20	_hw_exception_handler
Reserved by Xilinx for future use	C_BASE_VECTORS + 0x28 - C_BASE_VECTORS + 0x4F	-

1. With low-latency interrupt mode, the vector address is supplied by the Interrupt Controller.

The code expected at these locations is as shown below. For programs compiled without the `-x1-mode-xmdstub` compiler option, the `crt0.o` initialization file is passed by the `mb-gcc` compiler to the `mb-ld` linker for linking. This file sets the appropriate addresses of the exception handlers.

For programs compiled with the `-x1-mode-xmdstub` compiler option, the `crt1.o` initialization file is linked to the output program. This program has to be run with the `xmdstub` already loaded in the memory at address location 0x0. Hence at run-time, the initialization code in `crt1.o` writes the appropriate instructions to location 0x8 through 0x14 depending on the address of the exception and interrupt handlers.

The following is code for passing control to Exception and Interrupt handlers, assuming the default C\_BASE\_VECTORS value of 0x00000000:

```

0x00:  bri    _start1
0x04:  nop
0x08:  imm    high bits of address (user exception handler)
0x0c:  bri    _exception_handler
0x10:  imm    high bits of address (interrupt handler)
0x14:  bri    _interrupt_handler
0x20:  imm    high bits of address (HW exception handler)
0x24:  bri    _hw_exception_handler

```

With low-latency interrupt mode, control is directly passed to the interrupt handler for each individual interrupt utilizing this mode. In this case, it is the responsibility of each handler to save and restore used registers. The MicroBlaze C compiler (`mb-gcc`) attribute `fast_interrupt` is available to allow this task to be performed by the compiler:

```
void interrupt_handler_name() __attribute__((fast_interrupt));
```

MicroBlaze allows exception and interrupt handler routines to be located at any address location addressable using 32 bits.

The user exception handler code starts with the label `_exception_handler`, the hardware exception handler starts with `_hw_exception_handler`, while the interrupt handler code starts with the label `_interrupt_handler` for interrupts that do not use low-latency handlers.

In the current MicroBlaze system, there are dummy routines for interrupt and user exception handling, which you can change. In order to override these routines and link your own interrupt and exception handlers, you must define the handler code with specific attributes.

The interrupt handler code must be defined with attribute `interrupt_handler` to ensure that the compiler will generate code to save and restore used registers and emit an `rtid` instruction to return from the handler:

```
void function_name() __attribute__((interrupt_handler));
```

The user exception handler code must either be defined with either attribute `svc_handler` or attribute `svc_table_handler`:

```
void function_name() __attribute__((svc_handler));  
void function_name() __attribute__((svc_table_handler (ID)));
```

The first attribute ensures that the compiler will emit an indirect call to the handler with a `brki rD, 0x8` instruction, and emit an `rtbd` instruction to return from the handler. This means that when the MMU is enabled the handler function is executed in privileged mode.

The second attribute is declared with a Service ID. In this case the compiler will emit code to store this ID in register R18 followed by an indirect call to `_exception_handler` using a `brki rD, 0x8` instruction, and emit an `rtbd` instruction to return from the handler. It is necessary to override the `_exception_handler` function to call the appropriate handler based on the ID provided in R18.

For more details about the use and syntax of the handler attributes, please refer to the *GNU Compiler Tools* chapter in the *Embedded System Tools Reference Manual*.

When software breakpoints are used in the Xilinx Microprocessor Debug (XMD) tool or the Software Development Kit (SDK) tool, the Break (HW/SW) address location is reserved for handling the software breakpoint.



## MicroBlaze Instruction Set Architecture

---

This chapter provides a detailed guide to the Instruction Set Architecture of MicroBlaze™.

### Notation

The symbols used throughout this chapter are defined in [Table 5-1](#).

**Table 5-1: Symbol Notation**

Symbol	Meaning
+	Add
-	Subtract
×	Multiply
/	Divide
^	Bitwise logical AND
∨	Bitwise logical OR
⊕	Bitwise logical XOR
x	Bitwise logical complement of x
←	Assignment
>>	Right shift
<<	Left shift
rx	Register x
x[i]	Bit i in register x
x[i:j]	Bits i through j in register x
=	Equal comparison
≠	Not equal comparison
>	Greater than comparison
>=	Greater than or equal comparison
<	Less than comparison
<=	Less than or equal comparison
	Signal choice

Table 5-1: Symbol Notation (Continued)

Symbol	Meaning
<code>sxt(x)</code>	Sign-extend $x$
<code>Mem(x)</code>	Memory location at address $x$
<code>FSLx</code>	Stream interface $x$ (FSL or AXI)
<code>LSW(x)</code>	Least Significant Word of $x$
<code>isDnz(x)</code>	Floating point: true if $x$ is denormalized
<code>isInfinite(x)</code>	Floating point: true if $x$ is $+\infty$ or $-\infty$
<code>isPosInfinite(x)</code>	Floating point: true if $x$ is $+\infty$
<code>isNegInfinite(x)</code>	Floating point: true if $x$ is $-\infty$
<code>isNaN(x)</code>	Floating point: true if $x$ is a quiet or signalling NaN
<code>isZero(x)</code>	Floating point: true if $x$ is $+0$ or $-0$
<code>isQuietNaN(x)</code>	Floating point: true if $x$ is a quiet NaN
<code>isSigNaN(x)</code>	Floating point: true if $x$ is a signaling NaN
<code>signZero(x)</code>	Floating point: return $+0$ for $x > 0$ , and $-0$ if $x < 0$
<code>signInfinite(x)</code>	Floating point: return $+\infty$ for $x > 0$ , and $-\infty$ if $x < 0$



## Formats

MicroBlaze uses two instruction formats: Type A and Type B.

### Type A

Type A is used for register-register instructions. It contains the opcode, one destination and two source registers.

<b>Opcode</b>	<b>Destination Reg</b>	<b>Source Reg A</b>	<b>Source Reg B</b>	<b>0</b>	<b>0</b>	<b>0</b>	<b>0</b>	<b>0</b>	<b>0</b>	<b>0</b>	<b>0</b>	<b>0</b>	<b>0</b>	<b>0</b>	<b>0</b>
0	6	11	16	21											31

### Type B

Type B is used for register-immediate instructions. It contains the opcode, one destination and one source registers, and a source 16-bit immediate value.

<b>Opcode</b>	<b>Destination Reg</b>	<b>Source Reg A</b>	<b>Immediate Value</b>
0	6	11	16
			31

## Instructions

This section provides descriptions of MicroBlaze instructions. Instructions are listed in alphabetical order. For each instruction Xilinx provides the mnemonic, encoding, a description, pseudocode of its semantics, and a list of registers that it modifies.

## add

### Arithmetic Add

add	rD, rA, rB	Add
addc	rD, rA, rB	Add with Carry
addk	rD, rA, rB	Add and Keep Carry
addkc	rD, rA, rB	Add with Carry and Keep Carry

0	0	0	K	C	0	rD	rA	rB	0	0	0	0	0	0	0	0	0	0
0						6	1	1	2									3
							1	6	1									1

### Description

The sum of the contents of registers rA and rB, is placed into register rD.

Bit 3 of the instruction (labeled as K in the figure) is set to one for the mnemonic addk. Bit 4 of the instruction (labeled as C in the figure) is set to one for the mnemonic addc. Both bits are set to one for the mnemonic addkc.

When an add instruction has bit 3 set (addk, addkc), the carry flag will Keep its previous value regardless of the outcome of the execution of the instruction. If bit 3 is cleared (add, addc), then the carry flag will be affected by the execution of the instruction.

When bit 4 of the instruction is set to one (addc, addkc), the content of the carry flag (MSR[C]) affects the execution of the instruction. When bit 4 is cleared (add, addk), the content of the carry flag does not affect the execution of the instruction (providing a normal addition).

### Pseudocode

```

if C = 0 then
  (rD) ← (rA) + (rB)
else
  (rD) ← (rA) + (rB) + MSR[C]
if K = 0 then
  MSR[C] ← CarryOut

```

### Registers Altered

- rD
- MSR[C]

### Latency

1 cycle

### Note

The C bit in the instruction opcode is not the same as the carry bit in the MSR.

The “add r0, r0, r0” (= 0x00000000) instruction is never used by the compiler and usually indicates uninitialized memory. If you are using illegal instruction exceptions you can trap these instructions by setting the MicroBlaze parameter C\_OPCODE\_0x0\_ILLEGAL=1.

# addi

## Arithmetic Add Immediate

addi	rD, rA, IMM	Add Immediate
addic	rD, rA, IMM	Add Immediate with Carry
addik	rD, rA, IMM	Add Immediate and Keep Carry
addikc	rD, rA, IMM	Add Immediate with Carry and Keep Carry

0	0	1	K	C	0	rD	rA	IMM	
0						6	1	1	3
							1	6	1

## Description

The sum of the contents of registers rA and the value in the IMM field, sign-extended to 32 bits, is placed into register rD. Bit 3 of the instruction (labeled as K in the figure) is set to one for the mnemonic addik. Bit 4 of the instruction (labeled as C in the figure) is set to one for the mnemonic addic. Both bits are set to one for the mnemonic addikc.

When an addi instruction has bit 3 set (addik, addikc), the carry flag will keep its previous value regardless of the outcome of the execution of the instruction. If bit 3 is cleared (addi, addic), then the carry flag will be affected by the execution of the instruction.

When bit 4 of the instruction is set to one (addic, addikc), the content of the carry flag (MSR[C]) affects the execution of the instruction. When bit 4 is cleared (addi, addik), the content of the carry flag does not affect the execution of the instruction (providing a normal addition).

## Pseudocode

```

if C = 0 then
    (rD) ← (rA) + sext(IMM)
else
    (rD) ← (rA) + sext(IMM) + MSR[C]
if K = 0 then
    MSR[C] ← CarryOut

```

## Registers Altered

- rD
- MSR[C]

## Latency

1 cycle

## Notes

The C bit in the instruction opcode is not the same as the carry bit in the MSR.

By default, Type B Instructions take the 16-bit IMM field value and sign extend it to 32 bits to use as the immediate operand. This behavior can be overridden by preceding the Type B instruction with an imm instruction. See the instruction “imm,” [page 204](#) for details on using 32-bit immediate values.

# and

## Logical AND

and            rD, rA, rB

1	0	0	0	0	1	rD	rA	rB	0	0	0	0	0	0	0	0	0	0	0	
0						6	1	1	2											3
							1	6	1											1

### Description

The contents of register rA are ANDed with the contents of register rB; the result is placed into register rD.

### Pseudocode

$$(rD) \leftarrow (rA) \wedge (rB)$$

### Registers Altered

- rD

### Latency

1 cycle

# andi

Logical AND with Immediate

**andi**            rD, rA, IMM

1	0	1	0	0	1	rD	rA	IMM
0				6		1	1	3
						1	6	1

## Description

The contents of register rA are ANDed with the value of the IMM field, sign-extended to 32 bits; the result is placed into register rD.

## Pseudocode

$$(rD) \leftarrow (rA) \wedge \text{sext}(IMM)$$

## Registers Altered

- rD

## Latency

1 cycle

## Note

By default, Type B Instructions will take the 16-bit IMM field value and sign extend it to 32 bits to use as the immediate operand. This behavior can be overridden by preceding the Type B instruction with an imm instruction. See the instruction “imm,” page 204 for details on using 32-bit immediate values.

# andn

Logical AND NOT

**andn**      rD, rA, rB

1	0	0	0	1	1	rD	rA	rB	0	0	0	0	0	0	0	0	0	0	0	
0						6	1	1	2											3
							1	6	1											1

## Description

The contents of register rA are ANDed with the logical complement of the contents of register rB; the result is placed into register rD.

## Pseudocode

$$(rD) \leftarrow (rA) \wedge (\overline{rB})$$

## Registers Altered

- rD

## Latency

1 cycle

# andni

Logical AND NOT with Immediate

**andni**      rD, rA, IMM

1	0	1	0	1	1	<b>rD</b>	<b>rA</b>	<b>IMM</b>
0					6	1	1	3
						1	6	1

## Description

The IMM field is sign-extended to 32 bits. The contents of register rA are ANDed with the logical complement of the extended IMM field; the result is placed into register rD.

## Pseudocode

$$(rD) \leftarrow (rA) \wedge (\overline{\text{sext}(IMM)})$$

## Registers Altered

- rD

## Latency

1 cycle

## Note

By default, Type B Instructions will take the 16-bit IMM field value and sign extend it to 32 bits to use as the immediate operand. This behavior can be overridden by preceding the Type B instruction with an imm instruction. See the instruction “imm,” page 204 for details on using 32-bit immediate values.

## beq

### Branch if Equal

<b>beq</b>	rA, rB	Branch if Equal
<b>beqd</b>	rA, rB	Branch if Equal with Delay

1	0	0	1	1	1	D	0	0	0	0	rA	rB	0	0	0	0	0	0	0	0	0	0
0						6					1	1	2								3	
											1	6	1								1	

### Description

Branch if rA is equal to 0, to the instruction located in the offset value of rB. The target of the branch will be the instruction at address PC + rB.

The mnemonic beqd will set the D bit. The D bit determines whether there is a branch delay slot or not. If the D bit is set, it means that there is a delay slot and the instruction following the branch (that is, in the branch delay slot) is allowed to complete execution before executing the target instruction. If the D bit is not set, it means that there is no delay slot, so the instruction to be executed after the branch is the target instruction.

### Pseudocode

```

If rA = 0 then
  PC ← PC + rB
else
  PC ← PC + 4
if D = 1 then
  allow following instruction to complete execution

```

### Registers Altered

- PC

### Latency

- 1 cycle (if branch is not taken)
- 2 cycles (if branch is taken and the D bit is set)
- 3 cycles (if branch is taken and the D bit is not set)

### Note

A delay slot must not be used by the following: imm, branch, or break instructions. Interrupts and external hardware breaks are deferred until after the delay slot branch has been completed.



# beqi

## Branch Immediate if Equal

<b>beqi</b>	rA, IMM	Branch Immediate if Equal
<b>beqid</b>	rA, IMM	Branch Immediate if Equal with Delay

1 0 1 1 1 1	D 0 0 0 0	rA	IMM
0	6	1 1	1 6 3 1

### Description

Branch if rA is equal to 0, to the instruction located in the offset value of IMM. The target of the branch will be the instruction at address PC + IMM.

The mnemonic beqid will set the D bit. The D bit determines whether there is a branch delay slot or not. If the D bit is set, it means that there is a delay slot and the instruction following the branch (that is, in the branch delay slot) is allowed to complete execution before executing the target instruction. If the D bit is not set, it means that there is no delay slot, so the instruction to be executed after the branch is the target instruction.

### Pseudocode

```

If rA = 0 then
    PC ← PC + sext (IMM)
else
    PC ← PC + 4
if D = 1 then
    allow following instruction to complete execution
    
```

### Registers Altered

- PC

### Latency

- 1 cycle (if branch is not taken, or successful branch prediction occurs)
- 2 cycles (if branch is taken and the D bit is set)
- 3 cycles (if branch is taken and the D bit is not set, or a branch prediction mispredict occurs)

### Note

By default, Type B Instructions will take the 16-bit IMM field value and sign extend it to 32 bits to use as the immediate operand. This behavior can be overridden by preceding the Type B instruction with an imm instruction. See the instruction “imm,” page 204 for details on using 32-bit immediate values.

A delay slot must not be used by the following: imm, branch, or break instructions. Interrupts and external hardware breaks are deferred until after the delay slot branch has been completed.

## bge

### Branch if Greater or Equal

<b>bge</b>	rA, rB	Branch if Greater or Equal
<b>bged</b>	rA, rB	Branch if Greater or Equal with Delay

1	0	0	1	1	1	D	0	1	0	1	rA	rB	0	0	0	0	0	0	0	0	0	0
0						6					1	1	2									3
											1	6	1									1

### Description

Branch if rA is greater or equal to 0, to the instruction located in the offset value of rB. The target of the branch will be the instruction at address PC + rB.

The mnemonic bged will set the D bit. The D bit determines whether there is a branch delay slot or not. If the D bit is set, it means that there is a delay slot and the instruction following the branch (that is, in the branch delay slot) is allowed to complete execution before executing the target instruction. If the D bit is not set, it means that there is no delay slot, so the instruction to be executed after the branch is the target instruction.

### Pseudocode

```

If rA >= 0 then
    PC ← PC + rB
else
    PC ← PC + 4
if D = 1 then
    allow following instruction to complete execution

```

### Registers Altered

- PC

### Latency

- 1 cycle (if branch is not taken)
- 2 cycles (if branch is taken and the D bit is set)
- 3 cycles (if branch is taken and the D bit is not set)

### Note

A delay slot must not be used by the following: imm, branch, or break instructions. Interrupts and external hardware breaks are deferred until after the delay slot branch has been completed.

# bgei

## Branch Immediate if Greater or Equal

<b>bgei</b>	rA, IMM	Branch Immediate if Greater or Equal
<b>bgeid</b>	rA, IMM	Branch Immediate if Greater or Equal with Delay

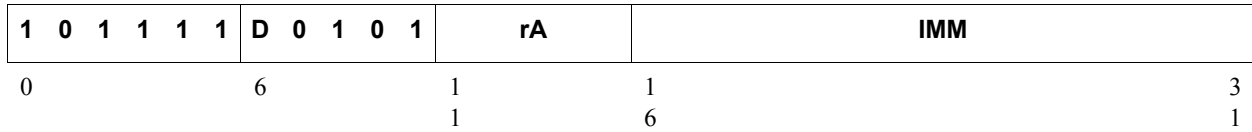

### Description

Branch if rA is greater or equal to 0, to the instruction located in the offset value of IMM. The target of the branch will be the instruction at address PC + IMM.

The mnemonic bgeid will set the D bit. The D bit determines whether there is a branch delay slot or not. If the D bit is set, it means that there is a delay slot and the instruction following the branch (that is, in the branch delay slot) is allowed to complete execution before executing the target instruction. If the D bit is not set, it means that there is no delay slot, so the instruction to be executed after the branch is the target instruction.

### Pseudocode

```

If rA >= 0 then
    PC ← PC + sext(IMM)
else
    PC ← PC + 4
if D = 1 then
    allow following instruction to complete execution
    
```

### Registers Altered

- PC

### Latency

- 1 cycle (if branch is not taken, or successful branch prediction occurs)
- 2 cycles (if branch is taken and the D bit is set)
- 3 cycles (if branch is taken and the D bit is not set, or a branch prediction mispredict occurs)

### Note

By default, Type B Instructions will take the 16-bit IMM field value and sign extend it to 32 bits to use as the immediate operand. This behavior can be overridden by preceding the Type B instruction with an imm instruction. See the instruction “imm,” page 204 for details on using 32-bit immediate values.

A delay slot must not be used by the following: imm, branch, or break instructions. Interrupts and external hardware breaks are deferred until after the delay slot branch has been completed.

## bgt

### Branch if Greater Than

<b>bgt</b>	rA, rB	Branch if Greater Than
<b>bgtD</b>	rA, rB	Branch if Greater Than with Delay

1	0	0	1	1	1	D	0	1	0	0	rA	rB	0	0	0	0	0	0	0	0	0	0
0						6					1	1	2								3	
											1	6	1								1	

### Description

Branch if rA is greater than 0, to the instruction located in the offset value of rB. The target of the branch will be the instruction at address PC + rB.

The mnemonic bgtD will set the D bit. The D bit determines whether there is a branch delay slot or not. If the D bit is set, it means that there is a delay slot and the instruction following the branch (that is, in the branch delay slot) is allowed to complete execution before executing the target instruction. If the D bit is not set, it means that there is no delay slot, so the instruction to be executed after the branch is the target instruction.

### Pseudocode

```

If rA > 0 then
  PC ← PC + rB
else
  PC ← PC + 4
if D = 1 then
  allow following instruction to complete execution

```

### Registers Altered

- PC

### Latency

- 1 cycle (if branch is not taken)
- 2 cycles (if branch is taken and the D bit is set)
- 3 cycles (if branch is taken and the D bit is not set)

### Note

A delay slot must not be used by the following: imm, branch, or break instructions. Interrupts and external hardware breaks are deferred until after the delay slot branch has been completed.

# bgti

## Branch Immediate if Greater Than

<b>bgti</b>	rA, IMM	Branch Immediate if Greater Than
<b>bgtid</b>	rA, IMM	Branch Immediate if Greater Than with Delay

1	0	1	1	1	1	D	0	1	0	0	rA	IMM
0						6					1	1
											1	6
												3
												1

## Description

Branch if rA is greater than 0, to the instruction located in the offset value of IMM. The target of the branch will be the instruction at address PC + IMM.

The mnemonic bgtid will set the D bit. The D bit determines whether there is a branch delay slot or not. If the D bit is set, it means that there is a delay slot and the instruction following the branch (that is, in the branch delay slot) is allowed to complete execution before executing the target instruction. If the D bit is not set, it means that there is no delay slot, so the instruction to be executed after the branch is the target instruction.

## Pseudocode

```

If rA > 0 then
  PC ← PC + sext(IMM)
else
  PC ← PC + 4
if D = 1 then
  allow following instruction to complete execution

```

## Registers Altered

- PC

## Latency

- 1 cycle (if branch is not taken, or successful branch prediction occurs)
- 2 cycles (if branch is taken and the D bit is set)
- 3 cycles (if branch is taken and the D bit is not set, or a branch prediction mispredict occurs)

## Note

By default, Type B Instructions will take the 16-bit IMM field value and sign extend it to 32 bits to use as the immediate operand. This behavior can be overridden by preceding the Type B instruction with an imm instruction. See the instruction “imm,” page 204 for details on using 32-bit immediate values.

A delay slot must not be used by the following: imm, branch, or break instructions. Interrupts and external hardware breaks are deferred until after the delay slot branch has been completed.

## ble

### Branch if Less or Equal

<b>ble</b>	rA, rB	Branch if Less or Equal
<b>bled</b>	rA, rB	Branch if Less or Equal with Delay

1	0	0	1	1	1	D	0	0	1	1	rA	rB	0	0	0	0	0	0	0	0	0	0													
0						6						1						1						2						3					
												1						6						1						1					

### Description

Branch if rA is less or equal to 0, to the instruction located in the offset value of rB. The target of the branch will be the instruction at address PC + rB.

The mnemonic bled will set the D bit. The D bit determines whether there is a branch delay slot or not. If the D bit is set, it means that there is a delay slot and the instruction following the branch (that is, in the branch delay slot) is allowed to complete execution before executing the target instruction. If the D bit is not set, it means that there is no delay slot, so the instruction to be executed after the branch is the target instruction.

### Pseudocode

```

If rA <= 0 then
  PC ← PC + rB
else
  PC ← PC + 4
if D = 1 then
  allow following instruction to complete execution

```

### Registers Altered

- PC

### Latency

- 1 cycle (if branch is not taken)
- 2 cycles (if branch is taken and the D bit is set)
- 3 cycles (if branch is taken and the D bit is not set)

### Note

A delay slot must not be used by the following: imm, branch, or break instructions. Interrupts and external hardware breaks are deferred until after the delay slot branch has been completed.

# blei

## Branch Immediate if Less or Equal

<b>blei</b>	rA, IMM	Branch Immediate if Less or Equal
<b>bleid</b>	rA, IMM	Branch Immediate if Less or Equal with Delay

1	0	1	1	1	1	D	0	0	1	1	rA	IMM	
0						6					1	1	3
											1	6	1

## Description

Branch if rA is less or equal to 0, to the instruction located in the offset value of IMM. The target of the branch will be the instruction at address PC + IMM.

The mnemonic bleid will set the D bit. The D bit determines whether there is a branch delay slot or not. If the D bit is set, it means that there is a delay slot and the instruction following the branch (that is, in the branch delay slot) is allowed to complete execution before executing the target instruction. If the D bit is not set, it means that there is no delay slot, so the instruction to be executed after the branch is the target instruction.

## Pseudocode

```

If rA <= 0 then
  PC ← PC + sext(IMM)
else
  PC ← PC + 4
if D = 1 then
  allow following instruction to complete execution

```

## Registers Altered

- PC

## Latency

- 1 cycle (if branch is not taken, or successful branch prediction occurs)
- 2 cycles (if branch is taken and the D bit is set)
- 3 cycles (if branch is taken and the D bit is not set, or a branch prediction mispredict occurs)

## Note

By default, Type B Instructions will take the 16-bit IMM field value and sign extend it to 32 bits to use as the immediate operand. This behavior can be overridden by preceding the Type B instruction with an imm instruction. See the instruction “imm,” page 204 for details on using 32-bit immediate values.

A delay slot must not be used by the following: imm, branch, or break instructions. Interrupts and external hardware breaks are deferred until after the delay slot branch has been completed.

## blt

### Branch if Less Than

<b>blt</b>	rA, rB	Branch if Less Than
<b>bltd</b>	rA, rB	Branch if Less Than with Delay

1	0	0	1	1	1	D	0	0	1	0	rA	rB	0	0	0	0	0	0	0	0	0	0
0						6					1	1	2									3
											1	6	1									1

### Description

Branch if rA is less than 0, to the instruction located in the offset value of rB. The target of the branch will be the instruction at address PC + rB.

The mnemonic bltd will set the D bit. The D bit determines whether there is a branch delay slot or not. If the D bit is set, it means that there is a delay slot and the instruction following the branch (that is, in the branch delay slot) is allowed to complete execution before executing the target instruction. If the D bit is not set, it means that there is no delay slot, so the instruction to be executed after the branch is the target instruction.

### Pseudocode

```

If rA < 0 then
  PC ← PC + rB
else
  PC ← PC + 4
if D = 1 then
  allow following instruction to complete execution

```

### Registers Altered

- PC

### Latency

- 1 cycle (if branch is not taken)
- 2 cycles (if branch is taken and the D bit is set)
- 3 cycles (if branch is taken and the D bit is not set)

### Note

A delay slot must not be used by the following: imm, branch, or break instructions. Interrupts and external hardware breaks are deferred until after the delay slot branch has been completed.



# blti

## Branch Immediate if Less Than

<b>blti</b>	rA, IMM	Branch Immediate if Less Than
<b>bltid</b>	rA, IMM	Branch Immediate if Less Than with Delay

1	0	1	1	1	1	D	0	0	1	0	rA	IMM
0						6					1	1
											1	6
												3
												1

### Description

Branch if rA is less than 0, to the instruction located in the offset value of IMM. The target of the branch will be the instruction at address PC + IMM.

The mnemonic bltid will set the D bit. The D bit determines whether there is a branch delay slot or not. If the D bit is set, it means that there is a delay slot and the instruction following the branch (that is, in the branch delay slot) is allowed to complete execution before executing the target instruction. If the D bit is not set, it means that there is no delay slot, so the instruction to be executed after the branch is the target instruction.

### Pseudocode

```

If rA < 0 then
    PC ← PC + sext (IMM)
else
    PC ← PC + 4
if D = 1 then
    allow following instruction to complete execution
    
```

### Registers Altered

- PC

### Latency

- 1 cycle (if branch is not taken, or successful branch prediction occurs)
- 2 cycles (if branch is taken and the D bit is set)
- 3 cycles (if branch is taken and the D bit is not set, or a branch prediction mispredict occurs)

### Note

By default, Type B Instructions will take the 16-bit IMM field value and sign extend it to 32 bits to use as the immediate operand. This behavior can be overridden by preceding the Type B instruction with an imm instruction. See the instruction “imm,” page 204 for details on using 32-bit immediate values.

A delay slot must not be used by the following: imm, branch, or break instructions. Interrupts and external hardware breaks are deferred until after the delay slot branch has been completed.

## bne

### Branch if Not Equal

<b>bne</b>	rA, rB	Branch if Not Equal
<b>bned</b>	rA, rB	Branch if Not Equal with Delay

1	0	0	1	1	1	D	0	0	0	1	rA	rB	0	0	0	0	0	0	0	0	0	0
0						6					1	1	2									3
											1	6	1									1

### Description

Branch if rA not equal to 0, to the instruction located in the offset value of rB. The target of the branch will be the instruction at address PC + rB.

The mnemonic bned will set the D bit. The D bit determines whether there is a branch delay slot or not. If the D bit is set, it means that there is a delay slot and the instruction following the branch (that is, in the branch delay slot) is allowed to complete execution before executing the target instruction. If the D bit is not set, it means that there is no delay slot, so the instruction to be executed after the branch is the target instruction.

### Pseudocode

```

If rA ≠ 0 then
    PC ← PC + rB
else
    PC ← PC + 4
if D = 1 then
    allow following instruction to complete execution

```

### Registers Altered

- PC

### Latency

- 1 cycle (if branch is not taken)
- 2 cycles (if branch is taken and the D bit is set)
- 3 cycles (if branch is taken and the D bit is not set)

### Note

A delay slot must not be used by the following: imm, branch, or break instructions. Interrupts and external hardware breaks are deferred until after the delay slot branch has been completed.

# bnei

## Branch Immediate if Not Equal

<b>bnei</b>	rA, IMM	Branch Immediate if Not Equal
<b>bneid</b>	rA, IMM	Branch Immediate if Not Equal with Delay

1	0	1	1	1	1	D	0	0	0	1	rA	IMM	
0						6					1	1	3
											1	6	1

## Description

Branch if rA not equal to 0, to the instruction located in the offset value of IMM. The target of the branch will be the instruction at address PC + IMM.

The mnemonic bneid will set the D bit. The D bit determines whether there is a branch delay slot or not. If the D bit is set, it means that there is a delay slot and the instruction following the branch (that is, in the branch delay slot) is allowed to complete execution before executing the target instruction. If the D bit is not set, it means that there is no delay slot, so the instruction to be executed after the branch is the target instruction.

## Pseudocode

```

If rA ≠ 0 then
    PC ← PC + sext(IMM)
else
    PC ← PC + 4
if D = 1 then
    allow following instruction to complete execution

```

## Registers Altered

- PC

## Latency

- 1 cycle (if branch is not taken, or successful branch prediction occurs)
- 2 cycles (if branch is taken and the D bit is set)
- 3 cycles (if branch is taken and the D bit is not set, or a branch prediction mispredict occurs)

## Note

By default, Type B Instructions will take the 16-bit IMM field value and sign extend it to 32 bits to use as the immediate operand. This behavior can be overridden by preceding the Type B instruction with an imm instruction. See the instruction “imm,” page 204 for details on using 32-bit immediate values.

A delay slot must not be used by the following: imm, branch, or break instructions. Interrupts and external hardware breaks are deferred until after the delay slot branch has been completed.

## br

### Unconditional Branch

<b>br</b>	rB	Branch
<b>bra</b>	rB	Branch Absolute
<b>brd</b>	rB	Branch with Delay
<b>brad</b>	rB	Branch Absolute with Delay
<b>brld</b>	rD, rB	Branch and Link with Delay
<b>brald</b>	rD, rB	Branch Absolute and Link with Delay

1 0 0 1 1 0	rD	D A L 0 0	rB	0 0 0 0 0 0 0 0 0 0
0	6	1	1	2
		1	6	1
				3
				1

### Description

Branch to the instruction located at address determined by rB.

The mnemonics brld and brald will set the L bit. If the L bit is set, linking will be performed. The current value of PC will be stored in rD.

The mnemonics bra, brad and brald will set the A bit. If the A bit is set, it means that the branch is to an absolute value and the target is the value in rB, otherwise, it is a relative branch and the target will be PC + rB.

The mnemonics brd, brad, brld and brald will set the D bit. The D bit determines whether there is a branch delay slot or not. If the D bit is set, it means that there is a delay slot and the instruction following the branch (that is, in the branch delay slot) is allowed to complete execution before executing the target instruction.

If the D bit is not set, it means that there is no delay slot, so the instruction to be executed after the branch is the target instruction.

### Pseudocode

```

if L = 1 then
  (rD) ← PC
if A = 1 then
  PC ← (rB)
else
  PC ← PC + (rB)
  if D = 1 then
    allow following instruction to complete execution

```

### Registers Altered

- rD
- PC

### Latency

- 2 cycles (if the D bit is set)
- 3 cycles (if the D bit is not set)

## Note

The instructions `brl` and `bral` are not available. A delay slot must not be used by the following: `imm`, `branch`, or `break` instructions. Interrupts and external hardware breaks are deferred until after the delay slot branch has been completed.

## bri

### Unconditional Branch Immediate

<b>bri</b>	IMM	Branch Immediate
<b>brai</b>	IMM	Branch Absolute Immediate
<b>brid</b>	IMM	Branch Immediate with Delay
<b>braid</b>	IMM	Branch Absolute Immediate with Delay
<b>brlid</b>	rD, IMM	Branch and Link Immediate with Delay
<b>bralid</b>	rD, IMM	Branch Absolute and Link Immediate with Delay

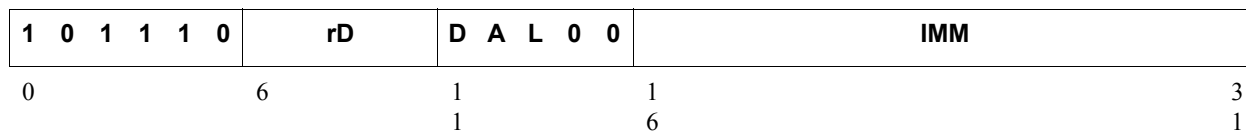

### Description

Branch to the instruction located at address determined by IMM, sign-extended to 32 bits.

The mnemonics brlid and bralid will set the L bit. If the L bit is set, linking will be performed. The current value of PC will be stored in rD.

The mnemonics brai, braid and bralid will set the A bit. If the A bit is set, it means that the branch is to an absolute value and the target is the value in IMM, otherwise, it is a relative branch and the target will be PC + IMM.

The mnemonics brid, braid, brlid and bralid will set the D bit. The D bit determines whether there is a branch delay slot or not. If the D bit is set, it means that there is a delay slot and the instruction following the branch (that is, in the branch delay slot) is allowed to complete execution before executing the target instruction. If the D bit is not set, it means that there is no delay slot, so the instruction to be executed after the branch is the target instruction.

As a special case, when MicroBlaze is configured to use an MMU ( $C\_USE\_MMU \geq 1$ ) and “bralid rD, C\_BASE\_VECTORS+0x8” is used to perform a User Vector Exception, the Machine Status Register bits User Mode and Virtual Mode are cleared.

### Pseudocode

```

if L = 1 then
    (rD) ← PC
if A = 1 then
    PC ← sext(IMM)
else
    PC ← PC + sext(IMM)
if D = 1 then
    allow following instruction to complete execution
if D = 1 and A = 1 and L = 1 and IMM = C_BASE_VECTORS+0x8 then
    MSR[UMS] ← MSR[UM]
    MSR[VMS] ← MSR[VM]
    MSR[UM] ← 0
    MSR[VM] ← 0

```

## Registers Altered

- rD
- PC
- MSR[UM], MSR[VM]

## Latency

- 1 cycle (if successful branch prediction occurs)
- 2 cycles (if the D bit is set)
- 3 cycles (if the D bit is not set, or a branch prediction mispredict occurs)

## Notes

The instructions brli and brali are not available.

By default, Type B Instructions will take the 16-bit IMM field value and sign extend it to 32 bits to use as the immediate operand. This behavior can be overridden by preceding the Type B instruction with an imm instruction. See the instruction “[imm](#),” [page 204](#) for details on using 32-bit immediate values.

A delay slot must not be used by the following: imm, branch, or break instructions. Interrupts and external hardware breaks are deferred until after the delay slot branch has been completed.





# brki

## Break Immediate

brki            rD, IMM

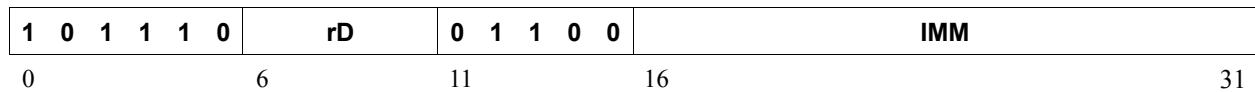

### Description

Branch and link to the instruction located at address value in IMM, sign-extended to 32 bits. The current value of PC will be stored in rD. The BIP flag in the MSR will be set, and the reservation bit will be cleared.

When MicroBlaze is configured to use an MMU ( $C\_USE\_MMU \geq 1$ ) this instruction is privileged, except as a special case when “brki rD, C\_BASE\_VECTORS+0x8” or “brki rD, C\_BASE\_VECTORS+0x18” is used to perform a Software Break. This means that, apart from the special case, if the instruction is attempted in User Mode ( $MSR[UM] = 1$ ) a Privileged Instruction exception occurs.

As a special case, when MicroBlaze is configured to use an MMU ( $C\_USE\_MMU \geq 1$ ) and “brki rD, C\_BASE\_VECTORS+0x8” or “brki rD, C\_BASE\_VECTORS+0x18” is used to perform a Software Break, the Machine Status Register bits User Mode and Virtual Mode are cleared.

### Pseudocode

```

if MSR[UM] and IMM ≠ C_BASE_VECTORS+0x8 and IMM ≠ C_BASE_VECTORS+0x18 then
    ESR[EC] ← 00111
else
    (rD) ← PC
    PC ← sext(IMM)
    MSR[BIP] ← 1
    Reservation ← 0
    if IMM = C_BASE_VECTORS+0x8 or IMM = C_BASE_VECTORS+0x18 then
        MSR[UMS] ← MSR[UM] MSR[UM] ← 0
        MSR[VMS] ← MSR[VM] MSR[VM] ← 0

```

### Registers Altered

- rD, unless an exception is generated, in which case the register is unchanged
- PC
- MSR[BIP], MSR[UM], MSR[VM]
- ESR[EC], in case a privileged instruction exception is generated

### Latency

- 3 cycles

### Note

By default, Type B Instructions will take the 16-bit IMM field value and sign extend it to 32 bits to use as the immediate operand. This behavior can be overridden by preceding the Type B instruction with an imm instruction. See the instruction “imm,” page 204 for details on using 32-bit immediate values.

As a special case, the imm instruction does not override a Software Break “brki rD, 0x18” when  $C\_USE\_DEBUG$  is set, irrespective of the value of  $C\_BASE\_VECTORS$ , to allow Software Break after an imm instruction.

## bs

### Barrel Shift

<b>bsrl</b>	rD, rA, rB	Barrel Shift Right Logical
<b>bsra</b>	rD, rA, rB	Barrel Shift Right Arithmetical
<b>bsll</b>	rD, rA, rB	Barrel Shift Left Logical

0	1	0	0	0	1	rD	rA	rB	S	T	0	0	0	0	0	0	0	0	0	
0						6	1	1	2											3
							1	6	1											1

### Description

Shifts the contents of register rA by the amount specified in register rB and puts the result in register rD.

The mnemonic bsll sets the S bit (Side bit). If the S bit is set, the barrel shift is done to the left. The mnemonics bsrl and bsra clear the S bit and the shift is done to the right.

The mnemonic bsra will set the T bit (Type bit). If the T bit is set, the barrel shift performed is Arithmetical. The mnemonics bsrl and bsll clear the T bit and the shift performed is Logical.

### Pseudocode

```

if S = 1 then
  (rD) ← (rA) << (rB) [27:31]
else
  if T = 1 then
    if ((rB) [27:31]) ≠ 0 then
      (rD) [0:(rB) [27:31]-1] ← (rA) [0]
      (rD) [(rB) [27:31]:31] ← (rA) >> (rB) [27:31]
    else
      (rD) ← (rA)
  else
    (rD) ← (rA) >> (rB) [27:31]

```

### Registers Altered

- rD

### Latency

- 1 cycle with C\_AREA\_OPTIMIZED=0
- 2 cycles with C\_AREA\_OPTIMIZED=1

### Note

These instructions are optional. To use them, MicroBlaze has to be configured to use barrel shift instructions (C\_USE\_BARREL=1).

**bsi****Barrel Shift Immediate**

<b>bsrli</b>	rD, rA, IMM	Barrel Shift Right Logical Immediate
<b>bsrai</b>	rD, rA, IMM	Barrel Shift Right Arithmetical Immediate
<b>bslli</b>	rD, rA, IMM	Barrel Shift Left Logical Immediate

0 1 1 0 0 1	rD	rA	0 0 0 0 0	S T 0 0 0 0	IMM
0	6	1	1	2	2
		1	6	1	7
					3
					1

**Description**

Shifts the contents of register rA by the amount specified by IMM and puts the result in register rD.

The mnemonic bsll sets the S bit (Side bit). If the S bit is set, the barrel shift is done to the left. The mnemonics bsrl and bsra clear the S bit and the shift is done to the right.

The mnemonic bsra will set the T bit (Type bit). If the T bit is set, the barrel shift performed is Arithmetical. The mnemonics bsrl and bsll clear the T bit and the shift performed is Logical.

**Pseudocode**

```

if S = 1 then
  (rD) ← (rA) << IMM
else
  if T = 1 then
    if IMM ≠ 0 then
      (rD) [0:IMM-1] ← (rA)[0]
      (rD) [IMM:31] ← (rA) >> IMM
    else
      (rD) ← (rA)
  else
    (rD) ← (rA) >> IMM

```

**Registers Altered**

- rD

**Latency**

- 1 cycle with C\_AREA\_OPTIMIZED=0
- 2 cycles with C\_AREA\_OPTIMIZED=1

**Notes**

These are not Type B Instructions. There is no effect from a preceding imm instruction.

These instructions are optional. To use them, MicroBlaze has to be configured to use barrel shift instructions (C\_USE\_BARREL=1).

# clz

## Count Leading Zeros

clz                      rD, rA                      Count leading zeros in rA

1	0	0	1	0	0	rD	rA	0	0	0	0	0	0	0	0	1	1	1	0	0	0	0	0
0						6	1	1					2										3
							1	6					1										1

### Description

This instruction counts the number of leading zeros in register rA starting from the most significant bit. The result is a number between 0 and 32, stored in register rD.

The result in rD is 32 when rA is 0, and it is 0 if rA is 0xFFFFFFFF.

### Pseudocode

```
n ← 0
while (rA)[n] = 0
    n ← n + 1
(rD) ← n
```

### Registers Altered

- rD

### Latency

- 1 cycle

### Notes

This instruction is only available when the parameter C\_USE\_PCMP\_INSTR is set to 1.

# cmp

## Integer Compare

cmp	rD, rA, rB	compare rB with rA (signed)
cmpu	rD, rA, rB	compare rB with rA (unsigned)

0 0 0 1 0 1	rD	rA	rB	0 0 0 0 0 0 0 0 U 1
0	6	1	1	2
		1	6	1

### Description

The contents of register rA is subtracted from the contents of register rB and the result is placed into register rD.

The MSB bit of rD is adjusted to shown true relation between rA and rB. If the U bit is set, rA and rB is considered unsigned values. If the U bit is clear, rA and rB is considered signed values.

### Pseudocode

$$(rD) \leftarrow (rB) + (\overline{rA}) + 1$$

$$(rD) (MSB) \leftarrow (rA) > (rB)$$

### Registers Altered

- rD

### Latency

- 1 cycle

# fadd

## Floating Point Arithmetic Add

fadd                    rD, rA, rB                    Add

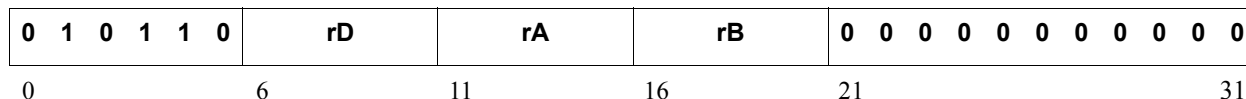

### Description

The floating point sum of registers rA and rB, is placed into register rD.

### Pseudocode

```

if isDnz(rA) or isDnz(rB) then
  (rD) ← 0xFFC00000
  FSR[DO] ← 1
  ESR[EC] ← 00110
else if isSigNaN(rA) or isSigNaN(rB) or
  (isPosInfinite(rA) and isNegInfinite(rB)) or
  (isNegInfinite(rA) and isPosInfinite(rB)) then
  (rD) ← 0xFFC00000
  FSR[IO] ← 1
  ESR[EC] ← 00110
else if isQuietNaN(rA) or isQuietNaN(rB) then
  (rD) ← 0xFFC00000
else if isDnz((rA)+(rB)) then
  (rD) ← signZero((rA)+(rB))
  FSR[UF] ← 1
  ESR[EC] ← 00110
else if isNaN((rA)+(rB)) then
  (rD) ← signInfinite((rA)+(rB))
  FSR[OF] ← 1
  ESR[EC] ← 00110
else
  (rD) ← (rA) + (rB)

```

### Registers Altered

- rD, unless an FP exception is generated, in which case the register is unchanged
- ESR[EC], if an FP exception is generated
- FSR[IO,UF,OF,DO]

### Latency

- 4 cycles with C\_AREA\_OPTIMIZED=0
- 6 cycles with C\_AREA\_OPTIMIZED=1

### Note

This instruction is only available when the MicroBlaze parameter C\_USE\_FPU is greater than 0.

# frsub

## Reverse Floating Point Arithmetic Subtraction

frsub                      rD, rA, rB                      Reverse subtract

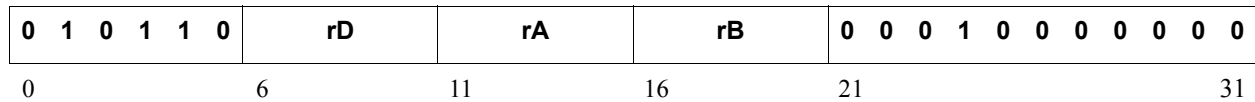

### Description

The floating point value in rA is subtracted from the floating point value in rB and the result is placed into register rD.

### Pseudocode

```

if isDnz(rA) or isDnz(rB) then
    (rD) ← 0xFFC00000
    FSR[DO] ← 1
    ESR[EC] ← 00110
else if (isSigNaN(rA) or isSigNaN(rB) or
        (isPosInfinite(rA) and isPosInfinite(rB)) or
        (isNegInfinite(rA) and isNegInfinite(rB))) then
    (rD) ← 0xFFC00000
    FSR[IO] ← 1
    ESR[EC] ← 00110
else if isQuietNaN(rA) or isQuietNaN(rB) then
    (rD) ← 0xFFC00000
else if isDnz((rB) - (rA)) then
    (rD) ← signZero((rB) - (rA))
    FSR[UF] ← 1
    ESR[EC] ← 00110
else if isNaN((rB) - (rA)) then
    (rD) ← signInfinite((rB) - (rA))
    FSR[OF] ← 1
    ESR[EC] ← 00110
else
    (rD) ← (rB) - (rA)

```

### Registers Altered

- rD, unless an FP exception is generated, in which case the register is unchanged
- ESR[EC], if an FP exception is generated
- FSR[IO,UF,OF,DO]

### Latency

- 4 cycles with C\_AREA\_OPTIMIZED=0
- 6 cycles with C\_AREA\_OPTIMIZED=1

### Note

This instruction is only available when the MicroBlaze parameter C\_USE\_FPU is greater than 0.

# fmul

## Floating Point Arithmetic Multiplication

fmul                    rD, rA, rB                    Multiply

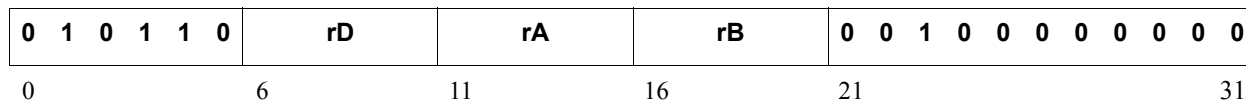

### Description

The floating point value in rA is multiplied with the floating point value in rB and the result is placed into register rD.

### Pseudocode

```

if isDnz(rA) or isDnz(rB) then
    (rD) ← 0xFFC00000
    FSR[DO] ← 1
    ESR[EC] ← 00110
else
    if isSigNaN(rA) or isSigNaN(rB) or (isZero(rA) and isInfinite(rB)) or
       (isZero(rB) and isInfinite(rA)) then
        (rD) ← 0xFFC00000
        FSR[IO] ← 1
        ESR[EC] ← 00110
    else if isQuietNaN(rA) or isQuietNaN(rB) then
        (rD) ← 0xFFC00000
    else if isDnz((rB)*(rA)) then
        (rD) ← signZero((rA)*(rB))
        FSR[UF] ← 1
        ESR[EC] ← 00110
    else if isNaN((rB)*(rA)) then
        (rD) ← signInfinite((rB)*(rA))
        FSR[OF] ← 1
        ESR[EC] ← 00110
    else
        (rD) ← (rB) * (rA)

```

### Registers Altered

- rD, unless an FP exception is generated, in which case the register is unchanged
- ESR[EC], if an FP exception is generated
- FSR[IO,UF,OF,DO]

### Latency

- 4 cycles with C\_AREA\_OPTIMIZED=0
- 6 cycles with C\_AREA\_OPTIMIZED=1

### Note

This instruction is only available when the MicroBlaze parameter C\_USE\_FPU is greater than 0.



**fdiv****Floating Point Arithmetic Division**

fdiv                      rD, rA, rB                      Divide

0	1	0	1	1	0	rD	rA	rB	0	0	1	1	0	0	0	0	0	0	0	
0						6	11	16	21											31

**Description**

The floating point value in rB is divided by the floating point value in rA and the result is placed into register rD.

**Pseudocode**

```

if isDnz(rA) or isDnz(rB) then
    (rD) ← 0xFFC00000
    FSR[DO] ← 1
    ESR[EC] ← 00110
else
    if isSigNaN(rA) or isSigNaN(rB) or (isZero(rA) and isZero(rB)) or
       (isInfinite(rA) and isInfinite(rB)) then
        (rD) ← 0xFFC00000
        FSR[IO] ← 1
        ESR[EC] ← 00110
    else if isQuietNaN(rA) or isQuietNaN(rB) then
        (rD) ← 0xFFC00000
    else if isZero(rA) and not isInfinite(rB) then
        (rD) ← signInfinite((rB)/(rA))
        FSR[DZ] ← 1
        ESR[EC] ← 00110
    else if isDnz((rB) / (rA)) then
        (rD) ← signZero((rB) / (rA))
        FSR[UF] ← 1
        ESR[EC] ← 00110
    else if isNaN((rB)/(rA)) then
        (rD) ← signInfinite((rB) / (rA))
        FSR[OF] ← 1
        ESR[EC] ← 00110
    else
        (rD) ← (rB) / (rA)

```

**Registers Altered**

- rD, unless an FP exception is generated, in which case the register is unchanged
- ESR[EC], if an FP exception is generated
- FSR[IO,UF,OF,DO,DZ]

**Latency**

- 28 cycles with C\_AREA\_OPTIMIZED=0, 30 cycles with C\_AREA\_OPTIMIZED=1

**Note**

This instruction is only available when the MicroBlaze parameter C\_USE\_FPU is greater than 0.

## fcmp

### Floating Point Number Comparison

fcmp.un	rD, rA, rB	Unordered floating point comparison
fcmp.lt	rD, rA, rB	Less-than floating point comparison
fcmp.eq	rD, rA, rB	Equal floating point comparison
fcmp.le	rD, rA, rB	Less-or-Equal floating point comparison
fcmp.gt	rD, rA, rB	Greater-than floating point comparison
fcmp.ne	rD, rA, rB	Not-Equal floating point comparison
fcmp.ge	rD, rA, rB	Greater-or-Equal floating point comparison

0	1	0	1	1	0	rD	rA	rB	0	1	0	0	OpSel	0	0	0	0	31
						6	11	16				21	25				28	31

### Description

The floating point value in rB is compared with the floating point value in rA and the comparison result is placed into register rD. The `OpSel` field in the instruction code determines the type of comparison performed.

### Pseudocode

```

if isDnz(rA) or isDnz(rB) then
    (rD) ← 0
    FSR[DO] ← 1
    ESR[EC] ← 00110
else
    {read out behavior from Table 5-2}

```

### Registers Altered

- rD, unless an FP exception is generated, in which case the register is unchanged
- ESR[EC], if an FP exception is generated
- FSR[IO,DO]

### Latency

- 1 cycle with `C_AREA_OPTIMIZED=0`
- 3 cycles with `C_AREA_OPTIMIZED=1`

### Note

These instructions are only available when the MicroBlaze parameter `C_USE_FPU` is greater than 0.

[Table 5-2, page 195](#) lists the floating point comparison operations.

Table 5-2: Floating Point Comparison Operation

Comparison Type		Operand Relationship				
Description	OpSel	(rB) > (rA)	(rB) < (rA)	(rB) = (rA)	isSigNaN(rA) or isSigNaN(rB)	isQuietNaN(rA) or isQuietNaN(rB)
Unordered	000	(rD) ← 0	(rD) ← 0	(rD) ← 0	(rD) ← 1 FSR[IO] ← 1 ESR[EC] ← 00110	(rD) ← 1
Less-than	001	(rD) ← 0	(rD) ← 1	(rD) ← 0	(rD) ← 0 FSR[IO] ← 1 ESR[EC] ← 00110	(rD) ← 0 FSR[IO] ← 1 ESR[EC] ← 00110
Equal	010	(rD) ← 0	(rD) ← 0	(rD) ← 1	(rD) ← 0 FSR[IO] ← 1 ESR[EC] ← 00110	(rD) ← 0
Less-or-equal	011	(rD) ← 0	(rD) ← 1	(rD) ← 1	(rD) ← 0 FSR[IO] ← 1 ESR[EC] ← 00110	(rD) ← 0 FSR[IO] ← 1 ESR[EC] ← 00110
Greater-than	100	(rD) ← 1	(rD) ← 0	(rD) ← 0	(rD) ← 0 FSR[IO] ← 1 ESR[EC] ← 00110	(rD) ← 0 FSR[IO] ← 1 ESR[EC] ← 00110
Not-equal	101	(rD) ← 1	(rD) ← 1	(rD) ← 0	(rD) ← 1 FSR[IO] ← 1 ESR[EC] ← 00110	(rD) ← 1
Greater-or-equal	110	(rD) ← 1	(rD) ← 0	(rD) ← 1	(rD) ← 0 FSR[IO] ← 1 ESR[EC] ← 00110	(rD) ← 0 FSR[IO] ← 1 ESR[EC] ← 00110

**flt****Floating Point Convert Integer to Float**

flt                    rD, rA

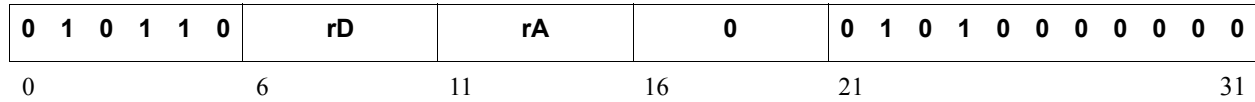
**Description**

Converts the signed integer in register rA to floating point and puts the result in register rD. This is a 32-bit rounding signed conversion that will produce a 32-bit floating point result.

**Pseudocode**

```
(rD) ← float ((rA))
```

**Registers Altered**

- rD

**Latency**

- 4 cycles with C\_AREA\_OPTIMIZED=0
- 6 cycles with C\_AREA\_OPTIMIZED=1

**Note**

This instruction is only available when the MicroBlaze parameter C\_USE\_FPU is set to 2 (Extended).

**fint****Floating Point Convert Float to Integer**

fint                      rD, rA

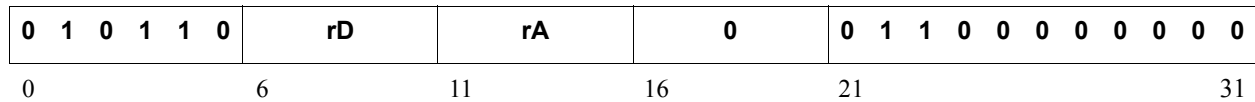
**Description**

Converts the floating point number in register rA to a signed integer and puts the result in register rD. This is a 32-bit signed conversion that will produce a 32-bit integer result.

**Pseudocode**

```

if isDnz(rA) then
    (rD) ← 0xFFC00000
    FSR[DO] ← 1
    ESR[EC] ← 00110
else if isNaN(rA) then
    (rD) ← 0xFFC00000
    FSR[IO] ← 1
    ESR[EC] ← 00110
else if isInf(rA) or (rA) < -231 or (rA) > 231 - 1 then
    (rD) ← 0xFFC00000
    FSR[IO] ← 1
    ESR[EC] ← 00110
else
    (rD) ← int ((rA))

```

**Registers Altered**

- rD, unless an FP exception is generated, in which case the register is unchanged
- ESR[EC], if an FP exception is generated
- FSR[IO,DO]

**Latency**

- 5 cycles with C\_AREA\_OPTIMIZED=0
- 7 cycles with C\_AREA\_OPTIMIZED=1

**Note**

This instruction is only available when the MicroBlaze parameter C\_USE\_FPU is set to 2 (Extended).

# fsqrt

## Floating Point Arithmetic Square Root

fsqrt                      rD, rA                      Square Root

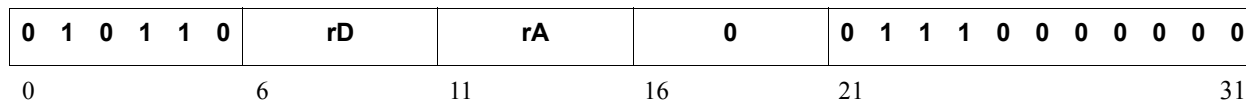

### Description

Performs a floating point square root on the value in rA and puts the result in register rD.

### Pseudocode

```

if isDnz(rA) then
    (rD) ← 0xFFC00000
    FSR[DO] ← 1
    ESR[EC] ← 00110
else if isSigNaN(rA) then
    (rD) ← 0xFFC00000
    FSR[IO] ← 1
    ESR[EC] ← 00110
else if isQuietNaN(rA) then
    (rD) ← 0xFFC00000
else if (rA) < 0 then
    (rD) ← 0xFFC00000
    FSR[IO] ← 1
    ESR[EC] ← 00110
else if (rA) = -0 then
    (rD) ← -0
else
    (rD) ← sqrt ((rA))

```

### Registers Altered

- rD, unless an FP exception is generated, in which case the register is unchanged
- ESR[EC], if an FP exception is generated
- FSR[IO,DO]

### Latency

- 27 cycles with C\_AREA\_OPTIMIZED=0
- 29 cycles with C\_AREA\_OPTIMIZED=1

### Note

This instruction is only available when the MicroBlaze parameter C\_USE\_FPU is set to 2 (Extended).



## Pseudocode

```

if MSR[UM] = 1 then
    ESR[EC] ← 00111
else
    x ← FSLx
    if x >= C_FSL_LINKS then
        x ← 0
    (rD) ← FSLx_S_DATA | Sx_AXIS_TDATA
    if (n = 1) then
        MSR[Carry] ← (FSLx_S_EXISTS | Sx_AXIS_TVALID)
    if (FSLx_S_CONTROL | Sx_AXIS_TLAST ≠ c) and
        (FSLx_S_EXISTS | Sx_AXIS_TVALID) then
        MSR[FSL] ← 1
        if (e = 1) then
            ESR[EC] ← 00000
            ESR[ESS] ← instruction bits [28:31]
            EDR ← FSLx_S_DATA | Sx_AXIS_TDATA

```

## Registers Altered

- rD, unless an exception is generated, in which case the register is unchanged
- MSR[FSL]
- MSR[Carry]
- ESR[EC], in case a stream exception or a privileged instruction exception is generated
- ESR[ESS], in case a stream exception is generated
- EDR, in case a stream exception is generated

## Latency

- 1 cycle with C\_AREA\_OPTIMIZED=0
- 2 cycles with C\_AREA\_OPTIMIZED=1

The blocking versions of this instruction will stall the pipeline of MicroBlaze until the instruction can be completed. Interrupts are served when the parameter C\_USE\_EXTENDED\_FSL\_INSTR is set to 1, and the instruction is not atomic.

## Note

To refer to an FSLx interface in assembly language, use rfsl0, rfsl1, ... rfsl15.

The blocking versions of this instruction should not be placed in a delay slot when the parameter C\_USE\_EXTENDED\_FSL\_INSTR is set to 1, since this prevents interrupts from being served.

For non-blocking versions, an rsubc instruction can be used to decrement an index variable.

The 'e' bit does not have any effect unless C\_FSL\_EXCEPTION is set to 1.

These instructions are only available when the MicroBlaze parameter C\_FSL\_LINKS is greater than 0.

The extended instructions (exception, test and atomic versions) are only available when the MicroBlaze parameter C\_USE\_EXTENDED\_FSL\_INSTR is set to 1.

It is not recommended to allow these instructions in user mode, unless absolutely necessary for performance reasons, since that removes all hardware protection preventing incorrect use of a link.





## Pseudocode

```

if MSR[UM] = 1 then
    ESR[EC] ← 00111
else
    x ← rB[28:31]
    if x >= C_FSL_LINKS then
        x ← 0
    (rD) ← FSLx_S_DATA | Sx_AXIS_TDATA
    if (n = 1) then
        MSR[Carry] ← (FSLx_S_EXISTS | Sx_AXIS_TVALID)
    if (FSLx_S_CONTROL | Sx_AXIS_TLAST ≠ c) and
        (FSLx_S_EXISTS | Sx_AXIS_TVALID) then
        MSR[FSL] ← 1
        if (e = 1) then
            ESR[EC] ← 00000
            ESR[ESS] ← rB[28:31]
            EDR ← FSLx_S_DATA | Sx_AXIS_TDATA

```

## Registers Altered

- rD, unless an exception is generated, in which case the register is unchanged
- MSR[FSL]
- MSR[Carry]
- ESR[EC], in case a stream exception or a privileged instruction exception is generated
- ESR[ESS], in case a stream exception is generated
- EDR, in case a stream exception is generated

## Latency

- 1 cycle with C\_AREA\_OPTIMIZED=0
- 2 cycles with C\_AREA\_OPTIMIZED=1

The blocking versions of this instruction will stall the pipeline of MicroBlaze until the instruction can be completed. Interrupts are served unless the instruction is atomic, which ensures that the instruction cannot be interrupted.

## Note

The blocking versions of this instruction should not be placed in a delay slot, since this prevents interrupts from being served.

For non-blocking versions, an rsubc instruction can be used to decrement an index variable.

The ‘e’ bit does not have any effect unless C\_FSL\_EXCEPTION is set to 1.

These instructions are only available when the MicroBlaze parameter C\_FSL\_LINKS is greater than 0 and the parameter C\_USE\_EXTENDED\_FSL\_INSTR is set to 1.

It is not recommended to allow these instructions in user mode, unless absolutely necessary for performance reasons, since that removes all hardware protection preventing incorrect use of a link.

# idiv

## Integer Divide

idiv	rD, rA, rB	divide rB by rA (signed)
idivu	rD, rA, rB	divide rB by rA (unsigned)

0	1	0	0	1	0	rD	rA	rB	0	0	0	0	0	0	0	0	0	0	U	0
0						6	1	1	2										3	
							1	6	1										1	

### Description

The contents of register rB is divided by the contents of register rA and the result is placed into register rD.

If the U bit is set, rA and rB are considered unsigned values. If the U bit is clear, rA and rB are considered signed values.

If the value of rA is 0, the DZO bit in MSR will be set and the value in rD will be 0, unless an exception is generated.

If the U bit is clear, the value of rA is -1, and the value of rB is -2147483648, the DZO bit in MSR will be set and the value in rD will be -2147483648, unless an exception is generated.

### Pseudocode

```

if (rA) = 0 then
    (rD)    <- 0
    MSR[DZO] <- 1
    ESR[EC] <- 00101
    ESR[DEC] <- 0
else if U = 0 and (rA) = -1 and (rB) = -2147483648 then
    (rD)    <- -2147483648
    MSR[DZO] <- 1
    ESR[EC] <- 00101
    ESR[DEC] <- 1
else
    (rD) ← (rB) / (rA)
    
```

### Registers Altered

- rD, unless a divide exception is generated, in which case the register is unchanged
- MSR[DZO], if the value in rA is zero
- ESR[EC], if the value in rA is zero

### Latency

- 1 cycle if (rA) = 0, otherwise 32 cycles with C\_AREA\_OPTIMIZED=0
- 1 cycle if (rA) = 0, otherwise 34 cycles with C\_AREA\_OPTIMIZED=1

### Note

This instruction is only valid if MicroBlaze is configured to use a hardware divider (C\_USE\_DIV = 1).

# imm

Immediate

imm

IMM

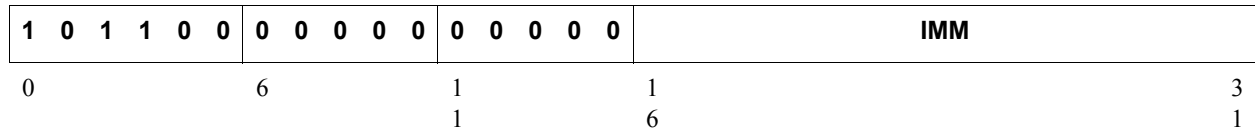

## Description

The instruction `imm` loads the IMM value into a temporary register. It also locks this value so it can be used by the following instruction and form a 32-bit immediate value.

The instruction `imm` is used in conjunction with Type B instructions. Since Type B instructions have only a 16-bit immediate value field, a 32-bit immediate value cannot be used directly. However, 32-bit immediate values can be used in MicroBlaze. By default, Type B Instructions will take the 16-bit IMM field value and sign extend it to 32 bits to use as the immediate operand. This behavior can be overridden by preceding the Type B instruction with an `imm` instruction. The `imm` instruction locks the 16-bit IMM value temporarily for the next instruction. A Type B instruction that immediately follows the `imm` instruction will then form a 32-bit immediate value from the 16-bit IMM value of the `imm` instruction (upper 16 bits) and its own 16-bit immediate value field (lower 16 bits). If no Type B instruction follows the `imm` instruction, the locked value gets unlocked and becomes useless.

## Latency

- 1 cycle

## Notes

The `imm` instruction and the Type B instruction following it are atomic; consequently, no interrupts are allowed between them.

The assembler provided by Xilinx automatically detects the need for `imm` instructions. When a 32-bit IMM value is specified in a Type B instruction, the assembler converts the IMM value to a 16-bit one to assemble the instruction and inserts an `imm` instruction before it in the executable file.





# lhu

## Load Halfword Unsigned

**lhu**            rD, rA, rB  
**lhur**          rD, rA, rB

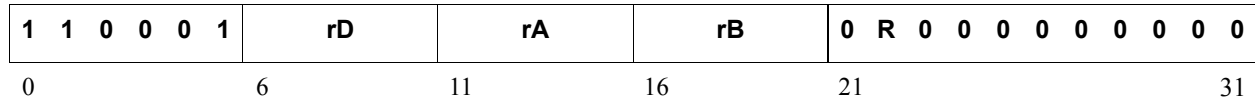

## Description

Loads a halfword (16 bits) from the halfword aligned memory location that results from adding the contents of registers rA and rB. The data is placed in the least significant halfword of register rD and the most significant halfword in rD is cleared.

If the R bit is set, a halfword reversed memory location is used and the two bytes in the halfword are reversed, loading data with the opposite endianness of the endianness defined by C\_ENDIANNES and the E bit (if virtual protected mode is enabled).

A data TLB miss exception occurs if virtual protected mode is enabled, and a valid translation entry corresponding to the address is not found in the TLB.

A data storage exception occurs if access is prevented by a no-access-allowed zone protection. This only applies to accesses with user mode and virtual protected mode enabled.

An unaligned data access exception occurs if the least significant bit in the address is not zero.

## Pseudocode

```

Addr ← (rA) + (rB)
if TLB_Miss(Addr) and MSR[VM] = 1 then
    ESR[EC] ← 10010; ESR[S] ← 0
    MSR[UMS] ← MSR[UM]; MSR[VMS] ← MSR[VM]; MSR[UM] ← 0; MSR[VM] ← 0
else if Access_Protected(Addr) and MSR[UM] = 1 and MSR[VM] = 1 then
    ESR[EC] ← 10000; ESR[S] ← 0; ESR[DIZ] ← 1
    MSR[UMS] ← MSR[UM]; MSR[VMS] ← MSR[VM]; MSR[UM] ← 0; MSR[VM] ← 0
else if Addr[31] ≠ 0 then
    ESR[EC] ← 00001; ESR[W] ← 0; ESR[S] ← 0; ESR[Rx] ← rD
else
    (rD)[16:31] ← Mem(Addr); (rD)[0:15] ← 0

```

## Registers Altered

- rD, unless an exception is generated, in which case the register is unchanged
- MSR[UM], MSR[VM], MSR[UMS], MSR[VMS], if an exception is generated
- ESR[EC], ESR[S], if an exception is generated
- ESR[DIZ], if a data storage exception is generated
- ESR[W], ESR[Rx], if an unaligned data access exception is generated

## Latency

- 1 cycle with C\_AREA\_OPTIMIZED=0
- 2 cycles with C\_AREA\_OPTIMIZED=1

## Note

The halfword reversed instruction is only valid if MicroBlaze is configured to use reorder instructions (C\_USE\_REORDER\_INSTR = 1).

# lhui

## Load Halfword Unsigned Immediate

lhui            rD, rA, IMM

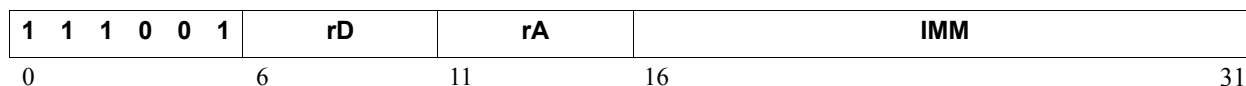

### Description

Loads a halfword (16 bits) from the halfword aligned memory location that results from adding the contents of register rA and the value in IMM, sign-extended to 32 bits. The data is placed in the least significant halfword of register rD and the most significant halfword in rD is cleared.

A data TLB miss exception occurs if virtual protected mode is enabled, and a valid translation entry corresponding to the address is not found in the TLB. A data storage exception occurs if access is prevented by a no-access-allowed zone protection. This only applies to accesses with user mode and virtual protected mode enabled. An unaligned data access exception occurs if the least significant bit in the address is not zero.

### Pseudocode

```

Addr ← (rA) + sext(IMM)
if TLB_Miss(Addr) and MSR[VM] = 1 then
    ESR[EC] ← 10010; ESR[S] ← 0
    MSR[UMS] ← MSR[UM]; MSR[VMS] ← MSR[VM]; MSR[UM] ← 0; MSR[VM] ← 0
else if Access_Protected(Addr) and MSR[UM] = 1 and MSR[VM] = 1 then
    ESR[EC] ← 10000; ESR[S] ← 0; ESR[DIZ] ← 1
    MSR[UMS] ← MSR[UM]; MSR[VMS] ← MSR[VM]; MSR[UM] ← 0; MSR[VM] ← 0
else if Addr[31] ≠ 0 then
    ESR[EC] ← 00001; ESR[W] ← 0; ESR[S] ← 0; ESR[Rx] ← rD
else
    (rD)[16:31] ← Mem(Addr)
    (rD)[0:15] ← 0

```

### Registers Altered

- rD, unless an exception is generated, in which case the register is unchanged
- MSR[UM], MSR[VM], MSR[UMS], MSR[VMS], if a TLB miss exception or a data storage exception is generated
- ESR[EC], ESR[S], if an exception is generated
- ESR[DIZ], if a data storage exception is generated
- ESR[W], ESR[Rx], if an unaligned data access exception is generated

### Latency

- 1 cycle with C\_AREA\_OPTIMIZED=0
- 2 cycles with C\_AREA\_OPTIMIZED=1

### Note

By default, Type B Instructions will take the 16-bit IMM field value and sign extend it to 32 bits to use as the immediate operand. This behavior can be overridden by preceding the Type B instruction with an imm instruction. See the instruction “imm,” page 204 for details on using 32-bit immediate values.



# lw

## Load Word

**lw**            rD, rA, rB  
**lwr**           rD, rA, rB

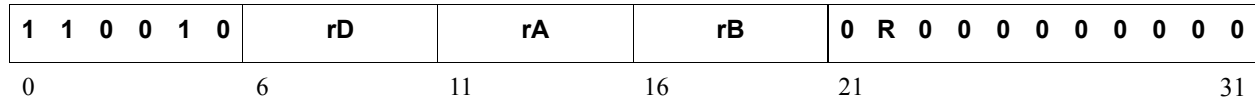

## Description

Loads a word (32 bits) from the word aligned memory location that results from adding the contents of registers rA and rB. The data is placed in register rD.

If the R bit is set, the bytes in the loaded word are reversed, loading data with the opposite endianness of the endianness defined by C\_ENDIANNESSESS and the E bit (if virtual protected mode is enabled).

A data TLB miss exception occurs if virtual protected mode is enabled, and a valid translation entry corresponding to the address is not found in the TLB.

A data storage exception occurs if access is prevented by a no-access-allowed zone protection. This only applies to accesses with user mode and virtual protected mode enabled.

An unaligned data access exception occurs if the two least significant bits in the address are not zero.

## Pseudocode

```

Addr ← (rA) + (rB)
if TLB_Miss(Addr) and MSR[VM] = 1 then
    ESR[EC] ← 10010; ESR[S] ← 0
    MSR[UMS] ← MSR[UM]; MSR[VMS] ← MSR[VM]; MSR[UM] ← 0; MSR[VM] ← 0
else if Access_Protected(Addr) and MSR[UM] = 1 and MSR[VM] = 1 then
    ESR[EC] ← 10000; ESR[S] ← 0; ESR[DIZ] ← 1
    MSR[UMS] ← MSR[UM]; MSR[VMS] ← MSR[VM]; MSR[UM] ← 0; MSR[VM] ← 0
else if Addr[30:31] ≠ 0 then
    ESR[EC] ← 00001; ESR[W] ← 1; ESR[S] ← 0; ESR[Rx] ← rD
else
    (rD) ← Mem(Addr)
    
```

## Registers Altered

- rD, unless an exception is generated, in which case the register is unchanged
- MSR[UM], MSR[VM], MSR[UMS], MSR[VMS], if a TLB miss exception or a data storage exception is generated
- ESR[EC], ESR[S], if an exception is generated
- ESR[DIZ], if a data storage exception is generated
- ESR[W], ESR[Rx], if an unaligned data access exception is generated

## Latency

- 1 cycle with C\_AREA\_OPTIMIZED=0
- 2 cycles with C\_AREA\_OPTIMIZED=1

## Note

The word reversed instruction is only valid if MicroBlaze is configured to use reorder instructions (C\_USE\_REORDER\_INSTR = 1).

# lwi

## Load Word Immediate

**lwi**                    rD, rA, IMM

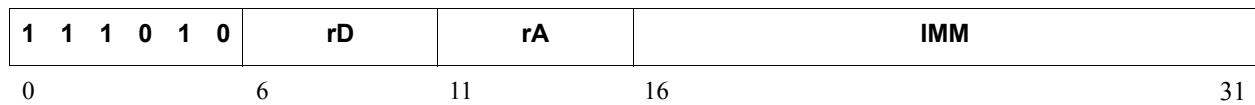

### Description

Loads a word (32 bits) from the word aligned memory location that results from adding the contents of register rA and the value IMM, sign-extended to 32 bits. The data is placed in register rD. A data TLB miss exception occurs if virtual protected mode is enabled, and a valid translation entry corresponding to the address is not found in the TLB. A data storage exception occurs if access is prevented by a no-access-allowed zone protection. This only applies to accesses with user mode and virtual protected mode enabled. An unaligned data access exception occurs if the two least significant bits in the address are not zero.

### Pseudocode

```

Addr ← (rA) + sext(IMM)
if TLB_Miss(Addr) and MSR[VM] = 1 then
    ESR[EC] ← 10010; ESR[S] ← 0
    MSR[UMS] ← MSR[UM]; MSR[VMS] ← MSR[VM]; MSR[UM] ← 0; MSR[VM] ← 0
else if Access_Protected(Addr) and MSR[UM] = 1 and MSR[VM] = 1 then
    ESR[EC] ← 10000; ESR[S] ← 0; ESR[DIZ] ← 1
    MSR[UMS] ← MSR[UM]; MSR[VMS] ← MSR[VM]; MSR[UM] ← 0; MSR[VM] ← 0
else if Addr[30:31] ≠ 0 then
    ESR[EC] ← 00001; ESR[W] ← 1; ESR[S] ← 0; ESR[Rx] ← rD
else
    (rD) ← Mem(Addr)

```

### Registers Altered

- rD, unless an exception is generated, in which case the register is unchanged
- MSR[UM], MSR[VM], MSR[UMS], MSR[VMS], if a TLB miss exception or a data storage exception is generated
- ESR[EC], ESR[S], if an exception is generated
- ESR[DIZ], if a data storage exception is generated
- ESR[W], ESR[Rx], if an unaligned data access exception is generated

### Latency

- 1 cycle with C\_AREA\_OPTIMIZED=0
- 2 cycles with C\_AREA\_OPTIMIZED=1

### Note

By default, Type B Instructions will take the 16-bit IMM field value and sign extend it to 32 bits to use as the immediate operand. This behavior can be overridden by preceding the Type B instruction with an imm instruction. See the instruction “imm,” page 204 for details on using 32-bit immediate values.

# lwx

## Load Word Exclusive

**lwx**                      rD, rA, rB

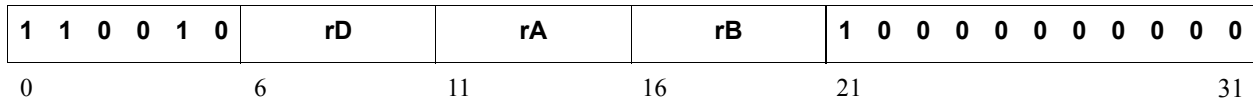

### Description

Loads a word (32 bits) from the word aligned memory location that results from adding the contents of registers rA and rB. The data is placed in register rD, and the reservation bit is set. If an AXI4 interconnect with exclusive access enabled is used, and the interconnect response is not EXOKAY, the carry flag (MSR[C]) is set; otherwise the carry flag is cleared.

A data TLB miss exception occurs if virtual protected mode is enabled, and a valid translation entry corresponding to the address is not found in the TLB.

A data storage exception occurs if access is prevented by a no-access-allowed zone protection. This only applies to accesses with user mode and virtual protected mode enabled.

An unaligned data access exception will *not* occur, even if the two least significant bits in the address are not zero.

A data bus exception can occur when an AXI4 interconnect with exclusive access enabled is used, and the interconnect response is not EXOKAY, which means that an exclusive access cannot be handled.

Enabling AXI exclusive access ensures that the operation is protected from other bus masters, but requires that the addressed slave supports exclusive access. When exclusive access is not enabled, only the internal reservation bit is used. Exclusive access is enabled using the two parameters C\_M\_AXI\_DP\_EXCLUSIVE\_ACCESS and C\_M\_AXI\_DC\_EXCLUSIVE\_ACCESS for the peripheral and cache interconnect, respectively.

### Pseudocode

```

Addr ← (rA) + (rB)
if TLB_Miss(Addr) and MSR[VM] = 1 then
    ESR[EC] ← 10010; ESR[S] ← 0
    MSR[UMS] ← MSR[UM]; MSR[VMS] ← MSR[VM]; MSR[UM] ← 0; MSR[VM] ← 0
else if Access_Protected(Addr) and MSR[UM] = 1 and MSR[VM] = 1 then
    ESR[EC] ← 10000; ESR[S] ← 0; ESR[DIZ] ← 1
    MSR[UMS] ← MSR[UM]; MSR[VMS] ← MSR[VM]; MSR[UM] ← 0; MSR[VM] ← 0
else if AXI_Exclusive(Addr) and AXI_Response ≠ EXOKAY and MSR[EE] then
    ESR[EC] ← 00100; ESR[ECC] ← 0;
    MSR[UMS] ← MSR[UM]; MSR[VMS] ← MSR[VM]; MSR[UM] ← 0; MSR[VM] ← 0
else
    (rD) ← Mem(Addr); Reservation ← 1;
    if AXI_Exclusive(Addr) and AXI_Response ≠ EXOKAY then
        MSR[C] ← 1
    else
        MSR[C] ← 0
    
```

## Registers Altered

- rD and MSR[C], unless an exception is generated, in which case they are unchanged
- MSR[UM], MSR[VM], MSR[UMS], MSR[VMS], if a TLB miss exception or a data storage exception is generated
- ESR[EC], ESR[S], if an exception is generated
- ESR[DIZ], if a data storage exception is generated

## Latency

- 1 cycle with C\_AREA\_OPTIMIZED=0
- 2 cycles with C\_AREA\_OPTIMIZED=1

## Note

This instruction is used together with SWX to implement exclusive access, such as semaphores and spinlocks.

The carry flag (MSR[C]) may not be set immediately (dependent on pipeline stall behavior). The LWX instruction should not be immediately followed by an MSRCLR, MSRSET, MTS, or SRC instruction, to ensure the correct value of the carry flag is obtained.

# mbar

## Memory Barrier

mbar                      IMM                      Memory Barrier

1	0	1	1	1	0	IMM	0	0	0	1	0	0	0	0	0	0	0	0	0	0	0	0	0	0	1	0	0		
0						6						11						16						31					

## Description

This instruction ensures that outstanding memory accesses on memory interfaces are completed before any subsequent instructions are executed. This is necessary to guarantee that self-modifying code is handled correctly, and that a DMA transfer can be safely started.

With self-modifying code, it is necessary to first use an MBAR instruction to wait for data accesses, which can be done by setting IMM to 1, and then use another MBAR instruction to clear the Branch Target Cache and empty the instruction prefetch buffer, which can be done by setting IMM to 2.

To ensure that data to be read by a DMA unit has been written to memory, it is only necessary to wait for data accesses, which can be done by setting IMM to 1.

When MicroBlaze is configured to use an MMU ( $C\_USE\_MMU \geq 1$ ) this instruction is privileged when the most significant bit in IMM is set to 1. This means that if the instruction is attempted in User Mode ( $MSR[UM] = 1$ ) a Privileged Instruction exception occurs.

When the most significant bit in IMM is set to 1 and no exception occurs, MicroBlaze enters sleep mode after all outstanding accesses have been completed, and sets the Sleep output signal to indicate this. The pipeline is halted, and MicroBlaze will not continue execution until a bit in the Wakeup input signal is asserted.

## Pseudocode

```

if (IMM & 1) = 0 then
    wait for instruction side memory accesses
if (IMM & 2) = 0 then
    wait for data side memory accesses
PC ← PC + 4
if (IMM & 16) = 16 then
    enter sleep mode

```

## Registers Altered

- PC
- ESR[EC], in case a privileged instruction exception is generated

## Latency

- 1 + N cycles, where N is the number of cycles to wait for memory accesses to complete

## Notes

This instruction must not be preceded by an imm instruction, and must not be placed in a delay slot.

With XCL, there is no way for this instruction to know when data writes are complete. Hence it is also necessary to read back the last written value in this case, to ensure that the access has completed.

The assembler pseudo-instruction sleep can be used instead of “mbar 16” to enter sleep mode.

# mfs

## Move From Special Purpose Register

mfs            rD, rS

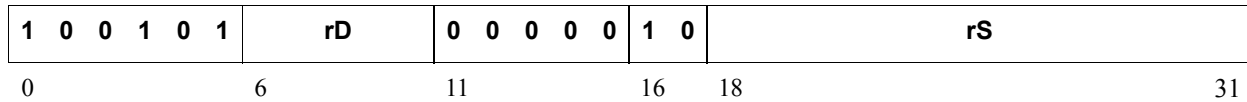

### Description

Copies the contents of the special purpose register rS into register rD. The special purpose registers TLBLO and TLBHI are used to copy the contents of the Unified TLB entry indexed by TLBX.

### Pseudocode

```

switch (rS):
case 0x0000 : (rD) ← PC
case 0x0001 : (rD) ← MSR
case 0x0003 : (rD) ← EAR
case 0x0005 : (rD) ← ESR
case 0x0007 : (rD) ← FSR
case 0x000B : (rD) ← BTR
case 0x000D : (rD) ← EDR
case 0x0800 : (rD) ← SLR
case 0x0802 : (rD) ← SHR
case 0x1000 : (rD) ← PID
case 0x1001 : (rD) ← ZPR
case 0x1002 : (rD) ← TLBX
case 0x1003 : (rD) ← TLBLO
case 0x1004 : (rD) ← TLBHI
case 0x200x : (rD) ← PVR[x] (where x = 0 to 12)
default : (rD) ← Undefined

```

### Registers Altered

- rD

### Latency

- 1 cycle

### Notes

To refer to special purpose registers in assembly language, use *rpc* for PC, *rmsr* for MSR, *rear* for EAR, *resr* for ESR, *rfsr* for FSR, *rbtr* for BTR, *redr* for EDR, *rslr* for SLR, *rshr* for SHR, *rpil* for PID, *rzpr* for ZPR, *rtlblo* for TLBLO, *rtlbhi* for TLBHI, *rtlbx* for TLBX, and *rpvr0* - *rpvr12* for PVR0 - PVR12.

The value read from MSR may not include effects of the immediately preceding instruction (dependent on pipeline stall behavior). An instruction that does not affect MSR must precede the MFS instruction to guarantee correct MSR value.

The value read from FSR may not include effects of the immediately preceding instruction (dependent on pipeline stall behavior). An instruction that does not affect FSR must precede the MFS instruction to guarantee correct FSR value.

EAR, ESR and BTR are only valid as operands when at least one of the MicroBlaze `C_*_EXCEPTION` parameters are set to 1.

EDR is only valid as operand when the parameter `C_FSL_EXCEPTION` is set to 1 and the parameter `C_FSL_LINKS` is greater than 0.

FSR is only valid as an operand when the `C_USE_FPU` parameter is greater than 0.

SLR and SHR are only valid as an operand when the `C_USE_STACK_PROTECTION` parameter is set to 1.

PID, ZPR, TLBLO and TLBHI are only valid as operands when the parameter `C_USE_MMU > 1` (User Mode) and the parameter `C_MMU_TLB_ACCESS = 1` (Read) or 3 (Full).

TLBX is only valid as operand when the parameter `C_USE_MMU > 1` (User Mode) and the parameter `C_MMU_TLB_ACCESS > 0` (Minimal).

PVR0 is only valid as an operand when `C_PVR` is 1 (Basic) or 2 (Full), and PVR1 - PVR12 are only valid as operands when `C_PVR` is set to 2 (Full).

# msrclr

Read MSR and clear bits in MSR

msrclr      rD, Imm

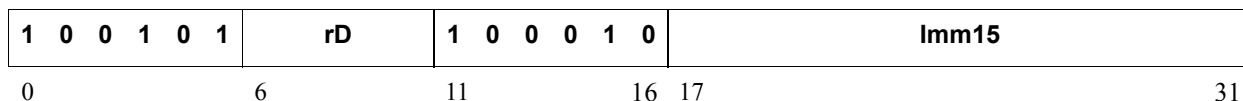

## Description

Copies the contents of the special purpose register MSR into register rD.

Bit positions in the IMM value that are 1 are cleared in the MSR. Bit positions that are 0 in the IMM value are left untouched.

When MicroBlaze is configured to use an MMU ( $C\_USE\_MMU \geq 1$ ) this instruction is privileged for all IMM values except those only affecting C. This means that if the instruction is attempted in User Mode ( $MSR[UM] = 1$ ) in this case a Privileged Instruction exception occurs.

## Pseudocode

```

if MSR[UM] = 1 and IMM ≠ 0x4 then
    ESR[EC] ← 00111
else
    (rD) ← (MSR)
    (MSR) ← (MSR) ∧ ( $\overline{IMM}$ )

```

## Registers Altered

- rD
- MSR
- ESR[EC], in case a privileged instruction exception is generated

## Latency

- 1 cycle

## Notes

MSRCLR will affect the Carry bit immediately while the remaining bits will take effect one cycle after the instruction has been executed. When clearing the IE bit, it is guaranteed that the processor will not react to any interrupt for the subsequent instructions.

The value read from MSR may not include effects of the immediately preceding instruction (dependent on pipeline stall behavior). An instruction that does not affect MSR must precede the MSRCLR instruction to guarantee correct MSR value. This applies to both the value copied to register rD and the changed MSR value itself.

The immediate values has to be less than  $2^{15}$  when  $C\_USE\_MMU \geq 1$  (User Mode), and less than  $2^{14}$  otherwise. Only bits 17 to 31 of the MSR can be cleared when  $C\_USE\_MMU \geq 1$  (User Mode), and bits 18 to 31 otherwise.

This instruction is only available when the parameter  $C\_USE\_MSR\_INSTR$  is set to 1.

When clearing MSR[VM] the instruction must always be followed by a synchronizing branch instruction, for example BRI 4.

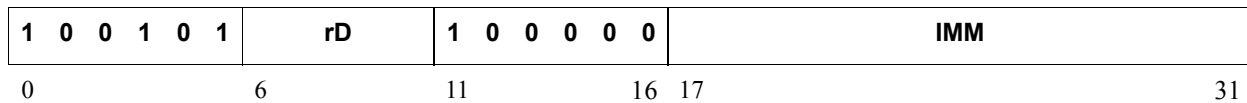

# msrset

**Read MSR and set bits in MSR****msrset**      rD, Imm

## Description

Copies the contents of the special purpose register MSR into register rD. Bit positions in the IMM value that are 1 are set in the MSR. Bit positions that are 0 in the IMM value are left untouched.

When MicroBlaze is configured to use an MMU ( $C\_USE\_MMU \geq 1$ ) this instruction is privileged for all IMM values except those only affecting C. This means that if the instruction is attempted in User Mode ( $MSR[UM] = 1$ ) in this case a Privileged Instruction exception occurs.

With low-latency interrupt mode ( $C\_USE\_INTERRUPT = 2$ ), the Interrupt\_Ack output port is set to 11 if the MSR{IE} bit is set by executing this instruction.

## Pseudocode

```

if MSR[UM] = 1 and IMM ≠ 0x4 then
    ESR[EC] ← 00111
else
    (rD) ← (MSR)
    (MSR) ← (MSR) ∨ (IMM)
    if (IMM) & 2
        Interrupt_Ack ← 11

```

## Registers Altered

- rD
- MSR
- ESR[EC], in case a privileged instruction exception is generated

## Latency

- 1 cycle

## Notes

MSRSET will affect the Carry bit immediately while the remaining bits will take effect one cycle after the instruction has been executed. When setting the EIP or BIP bit, it is guaranteed that the processor will not react to any interrupt or normal hardware break for the subsequent instructions.

The value read from MSR may not include effects of the immediately preceding instruction (dependent on pipeline stall behavior). An instruction that does not affect MSR must precede the MSRSET instruction to guarantee correct MSR value. This applies to both the value copied to register rD and the changed MSR value itself.

The immediate values has to be less than  $2^{15}$  when  $C\_USE\_MMU \geq 1$  (User Mode), and less than  $2^{14}$  otherwise. Only bits 17 to 31 of the MSR can be set when  $C\_USE\_MMU \geq 1$  (User Mode), and bits 18 to 31 otherwise.

This instruction is only available when the parameter  $C\_USE\_MSR\_INSTR$  is set to 1.

When setting MSR[VM] the instruction must always be followed by a synchronizing branch instruction, for example BRL 4.

**mts****Move To Special Purpose Register**

mts            rS, rA

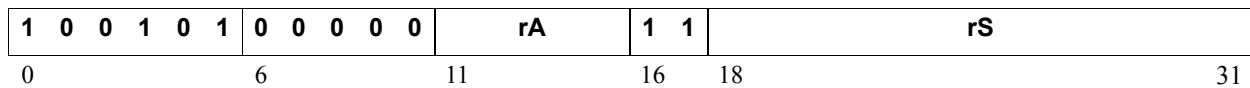
**Description**

Copies the contents of register rD into the special purpose register rS. The special purpose registers TLBLO and TLBHI are used to copy to the Unified TLB entry indexed by TLBX.

When MicroBlaze is configured to use an MMU (C\_USE\_MMU >= 1) this instruction is privileged. This means that if the instruction is attempted in User Mode (MSR [UM] = 1) a Privileged Instruction exception occurs.

With low-latency interrupt mode (C\_USE\_INTERRUPT = 2), the Interrupt\_Ack output port is set to 11 if the MSR [IE] bit is set by executing this instruction.

**Pseudocode**

```

if MSR[UM] = 1 then
    ESR[EC] ← 00111
else
    switch (rS)
        case 0x0001 : MSR ← (rA)
        case 0x0007 : FSR ← (rA)
        case 0x0800 : SLR ← (rA)
        case 0x0802 : SHR ← (rA)
        case 0x1000 : PID ← (rA)
        case 0x1001 : ZPR ← (rA)
        case 0x1002 : TLBX ← (rA)
        case 0x1003 : TLBLO ← (rA)
        case 0x1004 : TLBHI ← (rA)
        case 0x1005 : TLBSX ← (rA)
    if (rS) = 0x0001 and (rA) & 2
        Interrupt_Ack ← 11

```

**Registers Altered**

- rS
- ESR[EC], in case a privileged instruction exception is generated

**Latency**

- 1 cycle

**Notes**

When writing MSR using MTS, all bits take effect one cycle after the instruction has been executed. An MTS instruction writing MSR should never be followed back-to-back by an instruction that uses the MSR content. When clearing the IE bit, it is guaranteed that the processor will not react to any interrupt for the subsequent instructions. When setting the EIP or BIP bit, it is guaranteed that the processor will not react to any interrupt or normal hardware break for the subsequent instructions.



# mul

## Multiply

mul rD, rA, rB

0 1 0 0 0 0	rD	rA	rB	0 0 0 0 0 0 0 0 0 0
0	6	1	1	2
		1	6	1
				3
				1

### Description

Multiplies the contents of registers rA and rB and puts the result in register rD. This is a 32-bit by 32-bit multiplication that will produce a 64-bit result. The least significant word of this value is placed in rD. The most significant word is discarded.

### Pseudocode

$$(rD) \leftarrow \text{LSW}( (rA) \times (rB) )$$

### Registers Altered

- rD

### Latency

- 1 cycle with C\_AREA\_OPTIMIZED=0
- 3 cycles with C\_AREA\_OPTIMIZED=1

### Note

This instruction is only valid if the target architecture has multiplier primitives, and if present, the MicroBlaze parameter C\_USE\_HW\_MUL is greater than 0.

# mulh

**Multiply High**

**mulh**      rD, rA, rB

0	1	0	0	0	0	rD	rA	rB	0	0	0	0	0	0	0	0	0	0	1	
0						6	1	1	2											3
							1	6	1											1

## Description

Multiplies the contents of registers rA and rB and puts the result in register rD. This is a 32-bit by 32-bit signed multiplication that will produce a 64-bit result. The most significant word of this value is placed in rD. The least significant word is discarded.

## Pseudocode

$$(rD) \leftarrow \text{MSW} ( (rA) \times (rB) ), \text{ signed}$$

## Registers Altered

- rD

## Latency

- 1 cycle with C\_AREA\_OPTIMIZED=0
- 3 cycles with C\_AREA\_OPTIMIZED=1

## Note

This instruction is only valid if the target architecture has multiplier primitives, and if present, the MicroBlaze parameter C\_USE\_HW\_MUL is set to 2 (Mul64).

When MULH is used, bit 30 and 31 in the MUL instruction must be zero to distinguish between the two instructions. In previous versions of MicroBlaze, these bits were defined as zero, but the actual values were not relevant.

# mulhu

## Multiply High Unsigned

**mulhu**      rD, rA, rB

0	1	0	0	0	0		<b>rD</b>		<b>rA</b>		<b>rB</b>		0	0	0	0	0	0	0	0	0	0	1	1
0						6			1		1		2										3	
									1		6		1										1	

### Description

Multiplies the contents of registers rA and rB and puts the result in register rD. This is a 32-bit by 32-bit unsigned multiplication that will produce a 64-bit unsigned result. The most significant word of this value is placed in rD. The least significant word is discarded.

### Pseudocode

$$(rD) \leftarrow \text{MSW}( (rA) \times (rB) ), \text{ unsigned}$$

### Registers Altered

- rD

### Latency

- 1 cycle with C\_AREA\_OPTIMIZED=0
- 3 cycles with C\_AREA\_OPTIMIZED=1

### Note

This instruction is only valid if the target architecture has multiplier primitives, and if present, the MicroBlaze parameter C\_USE\_HW\_MUL is set to 2 (Mul64).

When MULHU is used, bit 30 and 31 in the MUL instruction must be zero to distinguish between the two instructions. In previous versions of MicroBlaze, these bits were defined as zero, but the actual values were not relevant.

## mulhsu Multiply High Signed Unsigned

**mulhsu**      rD, rA, rB

<b>0</b>	<b>1</b>	<b>0</b>	<b>0</b>	<b>0</b>	<b>0</b>	<b>0</b>	<b>rD</b>	<b>rA</b>	<b>rB</b>	<b>0</b>	<b>0</b>	<b>0</b>	<b>0</b>	<b>0</b>	<b>0</b>	<b>0</b>	<b>0</b>	<b>0</b>	<b>1</b>	<b>0</b>
0							6	1	1	2									3	
								1	6	1									1	

### Description

Multiplies the contents of registers rA and rB and puts the result in register rD. This is a 32-bit signed by 32-bit unsigned multiplication that will produce a 64-bit signed result. The most significant word of this value is placed in rD. The least significant word is discarded.

### Pseudocode

$$(rD) \leftarrow \text{MSW}(\text{rA}, \text{signed} \times (\text{rB}), \text{unsigned}), \text{signed}$$

### Registers Altered

- rD

### Latency

- 1 cycle with C\_AREA\_OPTIMIZED=0
- 3 cycles with C\_AREA\_OPTIMIZED=1

### Note

This instruction is only valid if the target architecture has multiplier primitives, and if present, the MicroBlaze parameter C\_USE\_HW\_MUL is set to 2 (Mul64).

When MULHSU is used, bit 30 and 31 in the MUL instruction must be zero to distinguish between the two instructions. In previous versions of MicroBlaze, these bits were defined as zero, but the actual values were not relevant.



# mul

## Multiply Immediate

**mul** rD, rA, IMM

0	1	1	0	0	0	rD	rA	IMM
0					6	1	1	3
						1	6	1

### Description

Multiplies the contents of registers rA and the value IMM, sign-extended to 32 bits; and puts the result in register rD. This is a 32-bit by 32-bit multiplication that will produce a 64-bit result. The least significant word of this value is placed in rD. The most significant word is discarded.

### Pseudocode

$$(rD) \leftarrow \text{LSW}( (rA) \times \text{sext}(IMM) )$$

### Registers Altered

- rD

### Latency

- 1 cycle with C\_AREA\_OPTIMIZED=0
- 3 cycles with C\_AREA\_OPTIMIZED=1

### Notes

By default, Type B Instructions will take the 16-bit IMM field value and sign extend it to 32 bits to use as the immediate operand. This behavior can be overridden by preceding the Type B instruction with an imm instruction. See the instruction “imm,” page 204 for details on using 32-bit immediate values.

This instruction is only valid if the target architecture has multiplier primitives, and if present, the MicroBlaze parameter C\_USE\_HW\_MUL is greater than 0.

**or****Logical OR****or**            rD, rA, rB

1	0	0	0	0	0		<b>rD</b>		<b>rA</b>		<b>rB</b>		0	0	0	0	0	0	0	0	0	0	0	0	0	0
0						6		1		1		2														3
								1		6		1														1

**Description**

The contents of register rA are ORed with the contents of register rB; the result is placed into register rD.

**Pseudocode**

$$(rD) \leftarrow (rA) \vee (rB)$$
**Registers Altered**

- rD

**Latency**

- 1 cycle

**Note**

The assembler pseudo-instruction nop is implemented as “or r0, r0, r0”.

# ori

Logical OR with Immediate

ori            rD, rA, IMM

1	0	1	0	0	0	rD	rA	IMM
0					6	1	1	3
						1	6	1

## Description

The contents of register rA are ORed with the extended IMM field, sign-extended to 32 bits; the result is placed into register rD.

## Pseudocode

$$(rD) \leftarrow (rA) \vee \text{sext}(IMM)$$

## Registers Altered

- rD

## Latency

- 1 cycle

## Note

By default, Type B Instructions will take the 16-bit IMM field value and sign extend it to 32 bits to use as the immediate operand. This behavior can be overridden by preceding the Type B instruction with an imm instruction. See the instruction “imm,” page 204 for details on using 32-bit immediate values.

# pcmpbf

## Pattern Compare Byte Find

pcmpbf      rD, rA, rB      bitwise comparison returning position of first match

1	0	0	0	0	0	rD	rA	rB	1	0	0	0	0	0	0	0	0	0	0	
0						6	1	1	2											3
							1	6	1											1

### Description

The contents of register rA is bitwise compared with the contents in register rB.

- rD is loaded with the position of the first matching byte pair, starting with MSB as position 1, and comparing until LSB as position 4
- If none of the byte pairs match, rD is set to 0

### Pseudocode

```

if rB[0:7] = rA[0:7] then
  (rD) ← 1
else
  if rB[8:15] = rA[8:15] then
    (rD) ← 2
  else
    if rB[16:23] = rA[16:23] then
      (rD) ← 3
    else
      if rB[24:31] = rA[24:31] then
        (rD) ← 4
      else
        (rD) ← 0

```

### Registers Altered

- rD

### Latency

- 1 cycle

### Note

This instruction is only available when the parameter C\_USE\_PCOMP\_INSTR is set to 1.

# pcmpeq

## Pattern Compare Equal

pcmpeq      rD, rA, rB      equality comparison with a positive boolean result

1 0 0 0 1 0	rD	rA	rB	1 0 0 0 0 0 0 0 0 0 0
0	6	1	1	2
		1	6	1
				3
				1

### Description

The contents of register rA is compared with the contents in register rB.

- rD is loaded with 1 if they match, and 0 if not

### Pseudocode

```

if (rB) = (rA) then
    (rD) ← 1
else
    (rD) ← 0
    
```

### Registers Altered

- rD

### Latency

- 1 cycle

### Note

This instruction is only available when the parameter C\_USE\_PCMP\_INSTR is set to 1.

## pcmpne

### Pattern Compare Not Equal

pcmpne      rD, rA, rB      equality comparison with a negative boolean result

1	0	0	0	1	1	rD	rA	rB	1	0	0	0	0	0	0	0	0	0	0	
0						6	1	1	2											3
							1	6	1											1

### Description

The contents of register rA is compared with the contents in register rB.

- rD is loaded with 0 if they match, and 1 if not

### Pseudocode

```
if (rB) = (rA) then
    (rD) ← 0
else
    (rD) ← 1
```

### Registers Altered

- rD

### Latency

- 1 cycle

### Note

This instruction is only available when the parameter C\_USE\_PCOMP\_INSTR is set to 1.

# put

## Put to stream interface

<i>n</i> aput	rA, FSLx	put data to link x <i>n</i> = non-blocking <i>a</i> = atomic
<i>tn</i> aput	FSLx	put data to link x test-only <i>n</i> = non-blocking <i>a</i> = atomic
<i>n</i> caput	rA, FSLx	put control to link x <i>n</i> = non-blocking <i>a</i> = atomic
<i>tn</i> caput	FSLx	put control to link x test-only <i>n</i> = non-blocking <i>a</i> = atomic

0	1	1	0	1	1	0	0	0	0	0	0	rA	1	n	c	t	a	0	0	0	0	0	0	0	0	0	0	FSLx	28	31																									
						0						6												11																16											28				31

### Description

MicroBlaze will write the value from register rA to the link x interface. If the available number of links set by C\_FSL\_LINKS is less than or equal to FSLx, link 0 is used.

The put instruction has 16 variants.

The blocking versions (when 'n' is '0') will stall MicroBlaze until there is space available in the interface. The non-blocking versions will not stall MicroBlaze and will set carry to '0' if space was available and to '1' if no space was available.

All data put instructions (when 'c' is '0') will set the control bit to the interface to '0' and all control put instructions (when 'c' is '1') will set the control bit to '1'.

The test versions (when 't' bit is '1') will be handled as the normal case, except that the write signal to the link is not asserted (thus no source register is required).

Atomic versions (when 'a' bit is '1') are not interruptible. This means that a sequence of atomic instructions can be grouped together without an interrupt breaking the program flow. However, note that exceptions may still occur.

When MicroBlaze is configured to use an MMU (C\_USE\_MMU >= 1) and not explicitly allowed by setting C\_MMU\_PRIVILEGED\_INSTR to 1 these instructions are privileged. This means that if these instructions are attempted in User Mode (MSR[UM] = 1) a Privileged Instruction exception occurs.

## Pseudocode

```

if MSR[UM] = 1 then
    ESR[EC] ← 00111
else
    x ← FSLx
    if x >= C_FSL_LINKS then
        x ← 0
    (FSLx_M_DATA | Mx_AXIS_TDATA) ← (rA)
    if (n = 1) then
        MSR[Carry] ←
            (FSLx_M_FULLL | Mx_AXIS_TVALID ^ Mx_AXIS_TREADY)
    (FSLx_M_CONTROL | Mx_AXIS_TLAST) ← C

```

## Registers Altered

- MSR[Carry]
- ESR[EC], in case a privileged instruction exception is generated

## Latency

- 1 cycle with C\_AREA\_OPTIMIZED=0
- 2 cycles with C\_AREA\_OPTIMIZED=1

The blocking versions of this instruction will stall the pipeline of MicroBlaze until the instruction can be completed. Interrupts are served when the parameter C\_USE\_EXTENDED\_FSL\_INSTR is set to 1, and the instruction is not atomic.

## Note

To refer to an FSLx interface in assembly language, use rfsl0, rfsl1, ... rfsl15.

The blocking versions of this instruction should not be placed in a delay slot when the parameter C\_USE\_EXTENDED\_FSL\_INSTR is set to 1, since this prevents interrupts from being served.

These instructions are only available when the MicroBlaze parameter C\_FSL\_LINKS is greater than 0.

The extended instructions (test and atomic versions) are only available when the MicroBlaze parameter C\_USE\_EXTENDED\_FSL\_INSTR is set to 1.

It is not recommended to allow these instructions in user mode, unless absolutely necessary for performance reasons, since that removes all hardware protection preventing incorrect use of a link.



# putd

## Put to stream interface dynamic

<i>naputd</i>	rA, rB	put data to link rB[28:31] <i>n</i> = non-blocking <i>a</i> = atomic
<i>tnaputd</i>	rB	put data to link rB[28:31] test-only <i>n</i> = non-blocking <i>a</i> = atomic
<i>ncaputd</i>	rA, rB	put control to link rB[28:31] <i>n</i> = non-blocking <i>a</i> = atomic
<i>tncaputd</i>	rB	put control to link rB[28:31] test-only <i>n</i> = non-blocking <i>a</i> = atomic

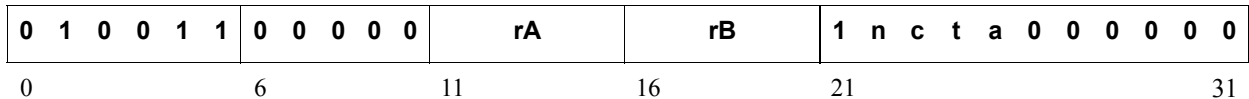

### Description

MicroBlaze will write the value from register rA to the link interface defined by the four least significant bits in rB. If the available number of links set by C\_FSL\_LINKS is less than or equal to the four least significant bits in rB, link 0 is used.

The putd instruction has 16 variants.

The blocking versions (when 'n' is '0') will stall MicroBlaze until there is space available in the interface. The non-blocking versions will not stall MicroBlaze and will set carry to '0' if space was available and to '1' if no space was available.

All data putd instructions (when 'c' is '0') will set the control bit to the interface to '0' and all control putd instructions (when 'c' is '1') will set the control bit to '1'.

The test versions (when 't' bit is '1') will be handled as the normal case, except that the write signal to the link is not asserted (thus no source register is required).

Atomic versions (when 'a' bit is '1') are not interruptible. This means that a sequence of atomic instructions can be grouped together without an interrupt breaking the program flow. However, note that exceptions may still occur.

When MicroBlaze is configured to use an MMU (C\_USE\_MMU >= 1) and not explicitly allowed by setting C\_MMU\_PRIVILEGED\_INSTR to 1 these instructions are privileged. This means that if these instructions are attempted in User Mode (MSR[UM] = 1) a Privileged Instruction exception occurs.

## Pseudocode

```

if MSR[UM] = 1 then
    ESR[EC] ← 00111
else
    x ← rB[28:31]
    if x >= C_FSL_LINKS then
        x ← 0
    (FSLx_M_DATA | Mx_AXIS_TDATA) ← (rA)
    if (n = 1) then
        MSR[Carry] ←
            (FSLx_M_FULLL | Mx_AXIS_TVALID ^ Mx_AXIS_TREADY)
    (FSLx_M_CONTROL | Mx_AXIS_TLAST) ← C

```

## Registers Altered

- MSR[Carry]
- ESR[EC], in case a privileged instruction exception is generated

## Latency

- 1 cycle with C\_AREA\_OPTIMIZED=0
- 2 cycles with C\_AREA\_OPTIMIZED=1

The blocking versions of this instruction will stall the pipeline of MicroBlaze until the instruction can be completed. Interrupts are served unless the instruction is atomic, which ensures that the instruction cannot be interrupted.

## Note

The blocking versions of this instruction should not be placed in a delay slot, since this prevents interrupts from being served.

These instructions are only available when the MicroBlaze parameter C\_FSL\_LINKS is greater than 0 and the parameter C\_USE\_EXTENDED\_FSL\_INSTR is set to 1.

It is not recommended to allow these instructions in user mode, unless absolutely necessary for performance reasons, since that removes all hardware protection preventing incorrect use of a link.

# rsub

## Arithmetic Reverse Subtract

rsub	rD, rA, rB	Subtract
rsubc	rD, rA, rB	Subtract with Carry
rsubk	rD, rA, rB	Subtract and Keep Carry
rsubkc	rD, rA, rB	Subtract with Carry and Keep Carry

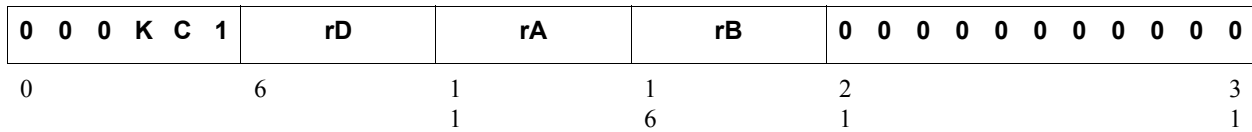

### Description

The contents of register rA is subtracted from the contents of register rB and the result is placed into register rD. Bit 3 of the instruction (labeled as K in the figure) is set to one for the mnemonic rsubk. Bit 4 of the instruction (labeled as C in the figure) is set to one for the mnemonic rsubc. Both bits are set to one for the mnemonic rsubkc.

When an rsub instruction has bit 3 set (rsubk, rsubkc), the carry flag will Keep its previous value regardless of the outcome of the execution of the instruction. If bit 3 is cleared (rsub, rsubc), then the carry flag will be affected by the execution of the instruction.

When bit 4 of the instruction is set to one (rsubc, rsubkc), the content of the carry flag (MSR[C]) affects the execution of the instruction. When bit 4 is cleared (rsub, rsubk), the content of the carry flag does not affect the execution of the instruction (providing a normal subtraction).

### Pseudocode

```

if C = 0 then
    (rD) ← (rB) + (rA) + 1
else
    (rD) ← (rB) + (rA) + MSR[C]
if K = 0 then
    MSR[C] ← CarryOut
    
```

### Registers Altered

- rD
- MSR[C]

### Latency

- 1 cycle

### Notes

In subtractions, Carry =  $\overline{\text{Borrow}}$ . When the Carry is set by a subtraction, it means that there is no Borrow, and when the Carry is cleared, it means that there is a Borrow.

## rsubi

### Arithmetic Reverse Subtract Immediate

rsubi	rD, rA, IMM	Subtract Immediate
rsubic	rD, rA, IMM	Subtract Immediate with Carry
rsubik	rD, rA, IMM	Subtract Immediate and Keep Carry
rsubikc	rD, rA, IMM	Subtract Immediate with Carry and Keep Carry

0	0	1	K	C	1	rD	rA	IMM	
0						6	1	1	3
							1	6	1

### Description

The contents of register rA is subtracted from the value of IMM, sign-extended to 32 bits, and the result is placed into register rD. Bit 3 of the instruction (labeled as K in the figure) is set to one for the mnemonic rsubik. Bit 4 of the instruction (labeled as C in the figure) is set to one for the mnemonic rsubic. Both bits are set to one for the mnemonic rsubikc.

When an rsubi instruction has bit 3 set (rsubik, rsubikc), the carry flag will Keep its previous value regardless of the outcome of the execution of the instruction. If bit 3 is cleared (rsubi, rsubic), then the carry flag will be affected by the execution of the instruction. When bit 4 of the instruction is set to one (rsubic, rsubikc), the content of the carry flag (MSR[C]) affects the execution of the instruction. When bit 4 is cleared (rsubi, rsubik), the content of the carry flag does not affect the execution of the instruction (providing a normal subtraction).

### Pseudocode

```

if C = 0 then
  (rD) ← sext(IMM) +  $\overline{(rA)}$  + 1
else
  (rD) ← sext(IMM) +  $\overline{(rA)}$  + MSR[C]
if K = 0 then
  MSR[C] ← CarryOut

```

### Registers Altered

- rD
- MSR[C]

### Latency

- 1 cycle

### Notes

In subtractions, Carry =  $\overline{\text{Borrow}}$ . When the Carry is set by a subtraction, it means that there is no Borrow, and when the Carry is cleared, it means that there is a Borrow. By default, Type B Instructions will take the 16-bit IMM field value and sign extend it to 32 bits to use as the immediate operand. This behavior can be overridden by preceding the Type B instruction with an imm instruction. See the instruction “imm,” page 204 for details on using 32-bit immediate values.

# rtbd

## Return from Break

**rtbd**            rA, IMM

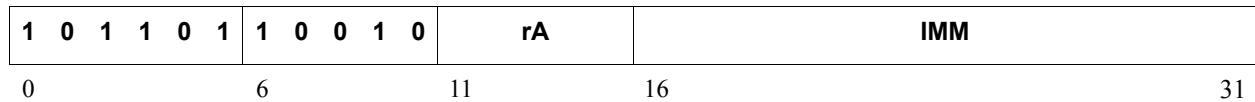

## Description

Return from break will branch to the location specified by the contents of rA plus the IMM field, sign-extended to 32 bits. It will also enable breaks after execution by clearing the BIP flag in the MSR.

This instruction always has a delay slot. The instruction following the RTBD is always executed before the branch target. That delay slot instruction has breaks disabled.

When MicroBlaze is configured to use an MMU (`C_USE_MMU >= 1`) this instruction is privileged. This means that if the instruction is attempted in User Mode (`MSR [UM] = 1`) a Privileged Instruction exception occurs.

## Pseudocode

```

if MSR[UM] = 1 then
    ESR[EC] ← 00111
else
    PC ← (rA) + sext(IMM)
    allow following instruction to complete execution
    MSR[BIP] ← 0
    MSR[UM] ← MSR[UMS]
    MSR[VM] ← MSR[VMS]

```

## Registers Altered

- PC
- MSR[BIP], MSR[UM], MSR[VM]
- ESR[EC], in case a privileged instruction exception is generated

## Latency

- 2 cycles

## Note

Convention is to use general purpose register r16 as rA.

A delay slot must not be used by the following: imm, branch, or break instructions. Interrupts and external hardware breaks are deferred until after the delay slot branch has been completed.

## rtid

### Return from Interrupt

rtid                    rA, IMM

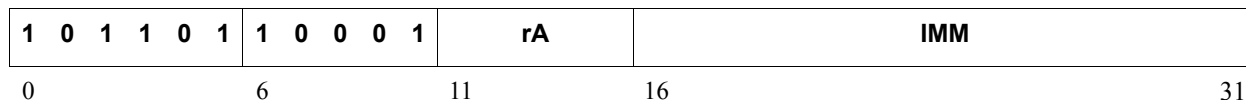

### Description

Return from interrupt will branch to the location specified by the contents of rA plus the IMM field, sign-extended to 32 bits. It will also enable interrupts after execution.

This instruction always has a delay slot. The instruction following the RTID is always executed before the branch target. That delay slot instruction has interrupts disabled.

When MicroBlaze is configured to use an MMU ( $C\_USE\_MMU \geq 1$ ) this instruction is privileged. This means that if the instruction is attempted in User Mode ( $MSR[UM] = 1$ ) a Privileged Instruction exception occurs.

With low-latency interrupt mode ( $C\_USE\_INTERRUPT = 2$ ), the Interrupt\_Ack output port is set to 10 when this instruction is executed, and subsequently to 11 when the  $MSR\{IE\}$  bit is set.

### Pseudocode

```

if MSR[UM] = 1 then
    ESR[EC] ← 00111
else
    PC ← (rA) + sext(IMM)
    Interrupt_Ack ← 10
    allow following instruction to complete execution
    MSR[IE] ← 1
    MSR[UM] ← MSR[Ums]
    MSR[VM] ← MSR[VMS]
    Interrupt_Ack ← 11

```

### Registers Altered

- PC
- MSR[IE], MSR[UM], MSR[VM]
- ESR[EC], in case a privileged instruction exception is generated

### Latency

- 2 cycles

### Note

Convention is to use general purpose register r14 as rA.

A delay slot must not be used by the following: imm, branch, or break instructions. Interrupts and external hardware breaks are deferred until after the delay slot branch has been completed.

# rted

## Return from Exception

rted                    rA, IMM

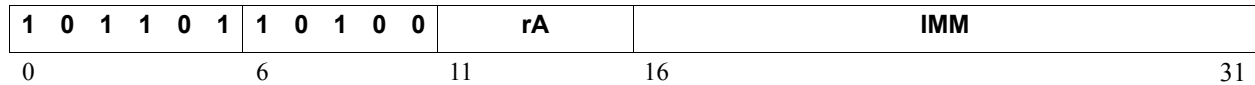

### Description

Return from exception will branch to the location specified by the contents of rA plus the IMM field, sign-extended to 32 bits. The instruction will also enable exceptions after execution.

This instruction always has a delay slot. The instruction following the RTED is always executed before the branch target.

When MicroBlaze is configured to use an MMU ( $C\_USE\_MMU \geq 1$ ) this instruction is privileged. This means that if the instruction is attempted in User Mode ( $MSR[UM] = 1$ ) a Privileged Instruction exception occurs.

### Pseudocode

```

if MSR[UM] = 1 then
    ESR[EC] ← 00111
else
    PC ← (rA) + sext(IMM)
    allow following instruction to complete execution
    MSR[EE] ← 1
    MSR[EIP] ← 0
    MSR[UM] ← MSR[UMS]
    MSR[VM] ← MSR[VMS]
    ESR ← 0

```

### Registers Altered

- PC
- MSR[EE], MSR[EIP], MSR[UM], MSR[VM]
- ESR

### Latency

- 2 cycles

### Note

Convention is to use general purpose register r17 as rA. This instruction requires that one or more of the MicroBlaze parameters  $C\_*_\_EXCEPTION$  are set to 1 or that  $C\_USE\_MMU > 0$ .

A delay slot must not be used by the following: imm, branch, or break instructions. Interrupts and external hardware breaks are deferred until after the delay slot branch has been completed.

The instruction should normally not be used when MSR[EE] is set, since if the instruction in the delay slot would cause an exception, the exception handler would be entered with exceptions enabled.

**Note:** Code returning from an exception must first check if MSR[DS] is set, and in that case return to the address in BTR.

## rtsd

### Return from Subroutine

**rtsd**            rA, IMM

1	0	1	1	0	1	1	0	0	0	0	rA	IMM					
0						6						1		1		3	
												1		6		1	

### Description

Return from subroutine will branch to the location specified by the contents of rA plus the IMM field, sign-extended to 32 bits.

This instruction always has a delay slot. The instruction following the RTSD is always executed before the branch target.

### Pseudocode

```
PC ← (rA) + sext(IMM)
allow following instruction to complete execution
```

### Registers Altered

- PC

### Latency

- 1 cycle (if successful branch prediction occurs)
- 2 cycles (with Branch Target Cache disabled)
- 3 cycles (if branch prediction mispredict occurs)

### Note

Convention is to use general purpose register r15 as rA.

A delay slot must not be used by the following: imm, branch, or break instructions. Interrupts and external hardware breaks are deferred until after the delay slot branch has been completed.



# sb

## Store Byte

**sb**            rD, rA, rB  
**sbr**            rD, rA, rB

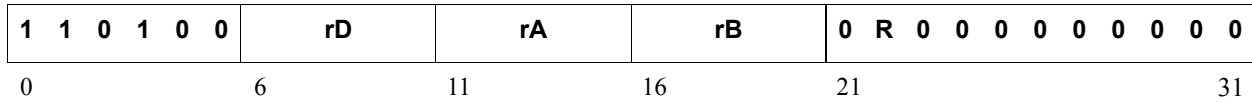

### Description

Stores the contents of the least significant byte of register rD, into the memory location that results from adding the contents of registers rA and rB.

If the R bit is set, a byte reversed memory location is used, storing data with the opposite endianness of the endianness defined by C\_ENDIANNES and the E bit (if virtual protected mode is enabled).

A data TLB miss exception occurs if virtual protected mode is enabled, and a valid translation entry corresponding to the address is not found in the TLB.

A data storage exception occurs if virtual protected mode is enabled, and access is prevented by no-access-allowed or read-only zone protection. No-access-allowed can only occur in user mode.

### Pseudocode

```

Addr ← (rA) + (rB)
if TLB_Miss(Addr) and MSR[VM] = 1 then
    ESR[EC] ← 10010; ESR[S] ← 1
    MSR[UMS] ← MSR[UM]; MSR[VMS] ← MSR[VM]; MSR[UM] ← 0; MSR[VM] ← 0
else if Access_Protected(Addr) and MSR[VM] = 1 then
    ESR[EC] ← 10000; ESR[S] ← 1; ESR[DIZ] ← No-access-allowed
    MSR[UMS] ← MSR[UM]; MSR[VMS] ← MSR[VM]; MSR[UM] ← 0; MSR[VM] ← 0
else
    Mem(Addr) ← (rD) [24:31]
    
```

### Registers Altered

- MSR[UM], MSR[VM], MSR[UMS], MSR[VMS], if an exception is generated
- ESR[EC], ESR[S], if an exception is generated
- ESR[DIZ], if a data storage exception is generated

### Latency

- 1 cycle with C\_AREA\_OPTIMIZED=0
- 2 cycles with C\_AREA\_OPTIMIZED=1

### Note

The byte reversed instruction is only valid if MicroBlaze is configured to use reorder instructions (C\_USE\_REORDER\_INSTR = 1).



**sext16**

Sign Extend Halfword

**sext16**      rD, rA

1	0	0	1	0	0	rD	rA	0	0	0	0	0	0	0	0	1	1	0	0	0	0	1	
0						6	1	1															3
							1	6															1

**Description**

This instruction sign-extends a halfword (16 bits) into a word (32 bits). Bit 16 in rA will be copied into bits 0-15 of rD. Bits 16-31 in rA will be copied into bits 16-31 of rD.

**Pseudocode**

```
(rD) [0:15] ← (rA) [16]
(rD) [16:31] ← (rA) [16:31]
```

**Registers Altered**

- rD

**Latency**

- 1 cycle

## sext8

Sign Extend Byte

**sext8**      rD, rA

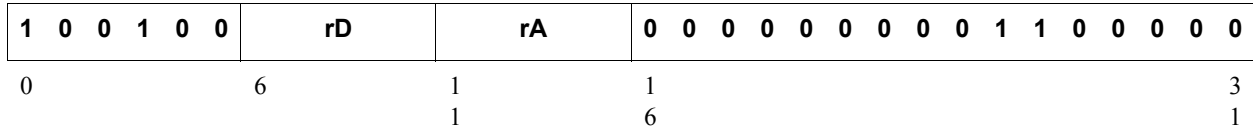

### Description

This instruction sign-extends a byte (8 bits) into a word (32 bits). Bit 24 in rA will be copied into bits 0-23 of rD. Bits 24-31 in rA will be copied into bits 24-31 of rD.

### Pseudocode

```
(rD) [0:23] ← (rA) [24]
(rD) [24:31] ← (rA) [24:31]
```

### Registers Altered

- rD

### Latency

- 1 cycle

# sh

## Store Halfword

**sh**            rD, rA, rB  
**shr**           rD, rA, rB

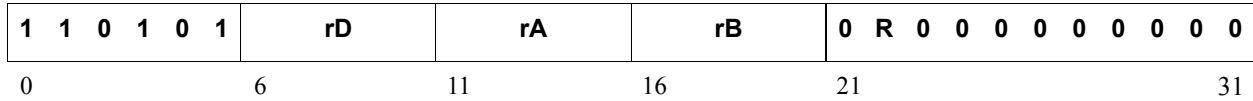

### Description

Stores the contents of the least significant halfword of register rD, into the halfword aligned memory location that results from adding the contents of registers rA and rB.

If the R bit is set, a halfword reversed memory location is used and the two bytes in the halfword are reversed, storing data with the opposite endianness of the endianness defined by C\_ENDIANNES and the E bit (if virtual protected mode is enabled).

A data TLB miss exception occurs if virtual protected mode is enabled, and a valid translation entry corresponding to the address is not found in the TLB.

A data storage exception occurs if virtual protected mode is enabled, and access is prevented by no-access-allowed or read-only zone protection. No-access-allowed can only occur in user mode.

An unaligned data access exception occurs if the least significant bit in the address is not zero.

### Pseudocode

```

Addr ← (rA) + (rB)
if TLB_Miss(Addr) and MSR[VM] = 1 then
    ESR[EC] ← 10010; ESR[S] ← 1
    MSR[UMS] ← MSR[UM]; MSR[VMS] ← MSR[VM]; MSR[UM] ← 0; MSR[VM] ← 0
else if Access_Protected(Addr) and MSR[VM] = 1 then
    ESR[EC] ← 10000; ESR[S] ← 1; ESR[DIZ] ← No-access-allowed
    MSR[UMS] ← MSR[UM]; MSR[VMS] ← MSR[VM]; MSR[UM] ← 0; MSR[VM] ← 0
else if Addr[31] ≠ 0 then
    ESR[EC] ← 00001; ESR[W] ← 0; ESR[S] ← 1; ESR[Rx] ← rD
else
    Mem(Addr) ← (rD) [16:31]
    
```

### Registers Altered

- MSR[UM], MSR[VM], MSR[UMS], MSR[VMS], if a TLB miss exception or a data storage exception is generated
- ESR[EC], ESR[S], if an exception is generated
- ESR[DIZ], if a data storage exception is generated
- ESR[W], ESR[Rx], if an unaligned data access exception is generated

### Latency

- 1 cycle with C\_AREA\_OPTIMIZED=0
- 2 cycles with C\_AREA\_OPTIMIZED=1

### Note

The halfword reversed instruction is only valid if MicroBlaze is configured to use reorder instructions (C\_USE\_REORDER\_INSTR = 1).

# shi

## Store Halfword Immediate

shi                    rD, rA, IMM

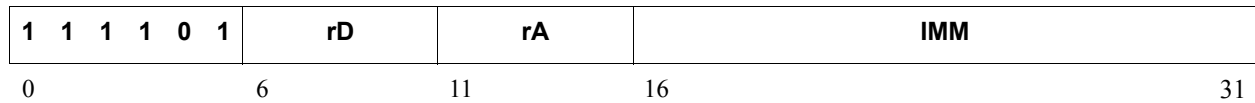

### Description

Stores the contents of the least significant halfword of register rD, into the halfword aligned memory location that results from adding the contents of register rA and the value IMM, sign-extended to 32 bits.

A data TLB miss exception occurs if virtual protected mode is enabled, and a valid translation entry corresponding to the address is not found in the TLB. A data storage exception occurs if virtual protected mode is enabled, and access is prevented by no-access-allowed or read-only zone protection. No-access-allowed can only occur in user mode. An unaligned data access exception occurs if the least significant bit in the address is not zero.

### Pseudocode

```

Addr ← (rA) + sext(IMM)
if TLB_Miss(Addr) and MSR[VM] = 1 then
    ESR[EC] ← 10010; ESR[S] ← 1
    MSR[UMS] ← MSR[UM]; MSR[VMS] ← MSR[VM]; MSR[UM] ← 0; MSR[VM] ← 0
else if Access_Protected(Addr) and MSR[VM] = 1 then
    ESR[EC] ← 10000; ESR[S] ← 1; ESR[DIZ] ← No-access-allowed
    MSR[UMS] ← MSR[UM]; MSR[VMS] ← MSR[VM]; MSR[UM] ← 0; MSR[VM] ← 0
else if Addr[31] ≠ 0 then
    ESR[EC] ← 00001; ESR[W] ← 0; ESR[S] ← 1; ESR[Rx] ← rD
else
    Mem(Addr) ← (rD)[16:31]

```

### Registers Altered

- MSR[UM], MSR[VM], MSR[UMS], MSR[VMS], if a TLB miss exception or a data storage exception is generated
- ESR[EC], ESR[S], if an exception is generated
- ESR[DIZ], if a data storage exception is generated
- ESR[W], ESR[Rx], if an unaligned data access exception is generated

### Latency

- 1 cycle with C\_AREA\_OPTIMIZED=0
- 2 cycles with C\_AREA\_OPTIMIZED=1

### Note

By default, Type B Instructions will take the 16-bit IMM field value and sign extend it to 32 bits to use as the immediate operand. This behavior can be overridden by preceding the Type B instruction with an imm instruction. See the instruction “imm,” page 204 for details on using 32-bit immediate values.



**src****Shift Right with Carry**

**src**                      rD, rA

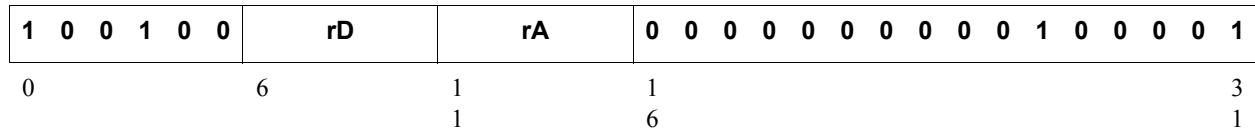
**Description**

Shifts the contents of register rA, one bit to the right, and places the result in rD. The Carry flag is shifted in the shift chain and placed in the most significant bit of rD. The least significant bit coming out of the shift chain is placed in the Carry flag.

**Pseudocode**

```
(rD) [0] ← MSR [C]
(rD) [1:31] ← (rA) [0:30]
MSR [C] ← (rA) [31]
```

**Registers Altered**

- rD
- MSR[C]

**Latency**

- 1 cycle



**srl****Shift Right Logical**

srl            rD, rA

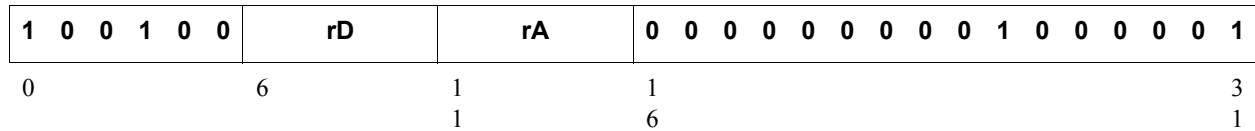
**Description**

Shifts logically the contents of register rA, one bit to the right, and places the result in rD. A zero is shifted in the shift chain and placed in the most significant bit of rD. The least significant bit coming out of the shift chain is placed in the Carry flag.

**Pseudocode**

```
(rD) [0] ← 0
(rD) [1:31] ← (rA) [0:30]
MSR[C] ← (rA) [31]
```

**Registers Altered**

- rD
- MSR[C]

**Latency**

- 1 cycle

**SW****Store Word**

**sw**            rD, rA, rB  
**swr**            rD, rA, rB

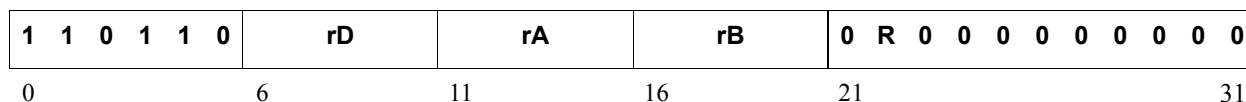
**Description**

Stores the contents of register rD, into the word aligned memory location that results from adding the contents of registers rA and rB.

If the R bit is set, the bytes in the stored word are reversed, storing data with the opposite endianness of the endianness defined by C\_ENDIANNES and the E bit (if virtual protected mode is enabled).

A data TLB miss exception occurs if virtual protected mode is enabled, and a valid translation entry corresponding to the address is not found in the TLB.

A data storage exception occurs if virtual protected mode is enabled, and access is prevented by no-access-allowed or read-only zone protection. No-access-allowed can only occur in user mode.

An unaligned data access exception occurs if the two least significant bits in the address are not zero.

**Pseudocode**

```

Addr ← (rA) + (rB)
if TLB_Miss(Addr) and MSR[VM] = 1 then
    ESR[EC] ← 10010; ESR[S] ← 1
    MSR[UMS] ← MSR[UM]; MSR[VMS] ← MSR[VM]; MSR[UM] ← 0; MSR[VM] ← 0
else if Access_Protected(Addr) and MSR[VM] = 1 then
    ESR[EC] ← 10000; ESR[S] ← 1; ESR[DIZ] ← No-access-allowed
    MSR[UMS] ← MSR[UM]; MSR[VMS] ← MSR[VM]; MSR[UM] ← 0; MSR[VM] ← 0
else if Addr[30:31] ≠ 0 then
    ESR[EC] ← 00001; ESR[W] ← 1; ESR[S] ← 1; ESR[Rx] ← rD
else
    Mem(Addr) ← (rD)[0:31]

```

**Registers Altered**

- MSR[UM], MSR[VM], MSR[UMS], MSR[VMS], if a TLB miss exception or a data storage exception is generated
- ESR[EC], ESR[S], if an exception is generated
- ESR[DIZ], if a data storage exception is generated
- ESR[W], ESR[Rx], if an unaligned data access exception is generated

**Latency**

- 1 cycle with C\_AREA\_OPTIMIZED=0
- 2 cycles with C\_AREA\_OPTIMIZED=1

**Note**

The word reversed instruction is only valid if MicroBlaze is configured to use reorder instructions (C\_USE\_REORDER\_INSTR = 1).

# swapb

**Swap Bytes****swapb**      rD, rA

1	0	0	1	0	0	rD	rA	0	0	0	0	0	0	0	1	1	1	1	0	0	0	0	0
0						6	1	1															3
							1	6															1

## Description

Swaps the contents of register rA treated as four bytes, and places the result in rD. This effectively converts the byte sequence in the register between endianness formats, either from little-endian to big-endian or vice versa.

## Pseudocode

```
(rD) [24:31] ← (rA) [0:7]
(rD) [16:23] ← (rA) [8:15]
(rD) [8:15]  ← (rA) [16:23]
(rD) [0:7]   ← (rA) [24:31]
```

## Registers Altered

- rD

## Latency

- 1 cycle

## Note

This instruction is only valid if MicroBlaze is configured to use reorder instructions (`C_USE_REORDER_INSTR = 1`).

# swaph

Swap Halfwords

**swaph**      rD, rA

1	0	0	1	0	0	rD	rA	0	0	0	0	0	0	0	1	1	1	1	0	0	0	1	0	
0						6	1	1																3
							1	6																1

## Description

Swaps the contents of register rA treated as two halfwords, and places the result in rD. This effectively converts the two halfwords in the register between endianness formats, either from little-endian to big-endian or vice versa.

## Pseudocode

```
(rD) [0:15] ← (rA) [16:31]
(rD) [16:31] ← (rA) [0:15]
```

## Registers Altered

- rD

## Latency

- 1 cycle

## Note

This instruction is only valid if MicroBlaze is configured to use reorder instructions (`C_USE_REORDER_INSTR = 1`).

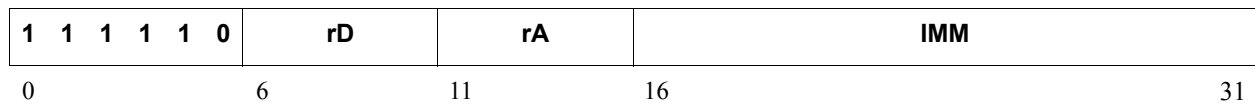
**swi****Store Word Immediate****swi**            rD, rA, IMM**Description**

Stores the contents of register rD, into the word aligned memory location that results from adding the contents of registers rA and the value IMM, sign-extended to 32 bits.

A data TLB miss exception occurs if virtual protected mode is enabled, and a valid translation entry corresponding to the address is not found in the TLB.

A data storage exception occurs if virtual protected mode is enabled, and access is prevented by no-access-allowed or read-only zone protection. No-access-allowed can only occur in user mode.

An unaligned data access exception occurs if the two least significant bits in the address are not zero.

**Pseudocode**

```

Addr ← (rA) + sext(IMM)
if TLB_Miss(Addr) and MSR[VM] = 1 then
    ESR[EC] ← 10010; ESR[S] ← 1
    MSR[UMS] ← MSR[UM]; MSR[VMS] ← MSR[VM]; MSR[UM] ← 0; MSR[VM] ← 0
else if Access_Protected(Addr) and MSR[VM] = 1 then
    ESR[EC] ← 10000; ESR[S] ← 1; ESR[DIZ] ← No-access-allowed
    MSR[UMS] ← MSR[UM]; MSR[VMS] ← MSR[VM]; MSR[UM] ← 0; MSR[VM] ← 0
else if Addr[30:31] ≠ 0 then
    ESR[EC] ← 00001; ESR[W] ← 1; ESR[S] ← 1; ESR[Rx] ← rD
else
    Mem(Addr) ← (rD)[0:31]

```

**Register Altered**

- MSR[UM], MSR[VM], MSR[UMS], MSR[VMS], if a TLB miss exception or a data storage exception is generated
- ESR[EC], ESR[S], if an exception is generated
- ESR[DIZ], if a data storage exception is generated
- ESR[W], ESR[Rx], if an unaligned data access exception is generated

**Latency**

- 1 cycle with C\_AREA\_OPTIMIZED=0
- 2 cycles with C\_AREA\_OPTIMIZED=1

**Note**

By default, Type B Instructions will take the 16-bit IMM field value and sign extend it to 32 bits to use as the immediate operand. This behavior can be overridden by preceding the Type B instruction with an imm instruction. See the instruction “imm,” page 204 for details on using 32-bit immediate values.

## SWX

### Store Word Exclusive

**swx**                    rD, rA, rB

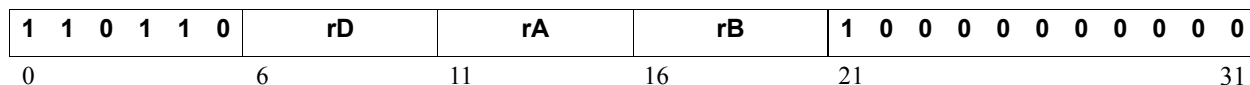

### Description

Conditionally stores the contents of register rD, into the word aligned memory location that results from adding the contents of registers rA and rB. If an AXI4 interconnect with exclusive access enabled is used, the store occurs if the interconnect response is EXOKAY, and the reservation bit is set; otherwise the store occurs when the reservation bit is set. The carry flag (MSR[C]) is set if the store does not occur, otherwise it is cleared. The reservation bit is cleared.

A data TLB miss exception occurs if virtual protected mode is enabled, and a valid translation entry corresponding to the address is not found in the TLB.

A data storage exception occurs if virtual protected mode is enabled, and access is prevented by no-access-allowed or read-only zone protection. No-access-allowed can only occur in user mode.

An unaligned data access exception will *not* occur even if the two least significant bits in the address are not zero.

Enabling AXI exclusive access ensures that the operation is protected from other bus masters, but requires that the addressed slave supports exclusive access. When exclusive access is not enabled, only the internal reservation bit is used. Exclusive access is enabled using the two parameters C\_M\_AXI\_DP\_EXCLUSIVE\_ACCESS and C\_M\_AXI\_DC\_EXCLUSIVE\_ACCESS for the peripheral and cache interconnect, respectively.

### Pseudocode

```

Addr ← (rA) + (rB)
if Reservation = 0 then
  MSR[C] ← 1
else
  if TLB_Miss(Addr) and MSR[VM] = 1 then
    ESR[EC] ← 10010; ESR[S] ← 1
    MSR[UMS] ← MSR[UM]; MSR[VMS] ← MSR[VM]; MSR[UM] ← 0; MSR[VM] ← 0
  else if Access_Protected(Addr) and MSR[VM] = 1 then
    ESR[EC] ← 10000; ESR[S] ← 1; ESR[DIZ] ← No-access-allowed
    MSR[UMS] ← MSR[UM]; MSR[VMS] ← MSR[VM]; MSR[UM] ← 0; MSR[VM] ← 0
  else
    Reservation ← 0
    if AXI_Exclusive(Addr) and AXI_Response ≠ EXOKAY then
      MSR[C] ← 1
    else
      Mem(Addr) ← (rD) [0:31]
      MSR[C] ← 0

```

## Registers Altered

- MSR[C], unless an exception is generated
- MSR[UM], MSR[VM], MSR[UMS], MSR[VMS], if a TLB miss exception or a data storage exception is generated
- ESR[EC], ESR[S], if an exception is generated
- ESR[DIZ], if a data storage exception is generated

## Latency

- 1 cycle with C\_AREA\_OPTIMIZED=0
- 2 cycles with C\_AREA\_OPTIMIZED=1

## Note

This instruction is used together with LWX to implement exclusive access, such as semaphores and spinlocks .

The carry flag (MSR[C]) may not be set immediately (dependent on pipeline stall behavior). The SWX instruction should not be immediately followed by an MSRCLR, MSRSET, MTS, or SRC instruction, to ensure the correct value of the carry flag is obtained.

## wdc

### Write to Data Cache

**wdc**            rA,rB  
**wdc.flush**    rA,rB  
**wdc.clear**     rA,rB  
**wdc.ext.flush** rA,rB  
**wdc.ext.clear** rA,rB

1	0	0	1	0	0	0	0	0	0	0	rA	rB	E	0	0	0	1	1	F	0	1	T	0
0						6					1	1	2					2				3	
											1	6	1					7				1	

### Description

Write into the data cache tag to invalidate or flush a cache line. The mnemonic **wdc.flush** is used to set the F bit, **wdc.clear** is used to set the T bit, **wdc.ext.flush** is used to set the E, F and T bits, and **wdc.ext.clear** is used to set the E and T bits.

When `C_DCACHE_USE_WRITEBACK` is set to 1, the instruction will flush the cache line and invalidate it if the F bit is set, otherwise it will only invalidate the cache line and discard any data that has not been written to memory. If the T bit is set, only a cache line with a matching address is invalidated. Register rA added with rB is the address of the affected cache line. The E bit is not taken into account.

When `C_DCACHE_USE_WRITEBACK` is cleared to 0, the instruction will invalidate the cache line if the E bit is not set. Register rA contains the address of the affected cache line, and the register rB value is not used. If the E bit is set to 1, MicroBlaze will request that the matching address in an external cache should be invalidated or flushed, depending on the value of the F bit. The E bit is only taken into account when the parameter `C_INTERCONNECT` is set to 3 (ACE).

When MicroBlaze is configured to use an MMU (`C_USE_MMU >= 1`) the instruction is privileged. This means that if the instruction is attempted in User Mode (`MSR[UM] = 1`) a Privileged Instruction exception occurs.

### Pseudocode

```

if MSR[UM] = 1 then
    ESR[EC] ← 00111
else
    if C_DCACHE_USE_WRITEBACK = 1 then
        address ← (Ra) + (Rb)
    else
        address ← (Ra)
    if E = 0 then
        if C_DCACHE_LINE_LEN = 4 then
            cacheline_mask ← (1 << log2(C_DCACHE_BYTE_SIZE) - 4) - 1
            cacheline ← (DCache Line)[(address >> 4) ^ cacheline_mask]
            cacheline_addr ← address & 0xffffffff0
        if C_DCACHE_LINE_LEN = 8 then
            cacheline_mask ← (1 << log2(C_DCACHE_BYTE_SIZE) - 5) - 1
            cacheline ← (DCache Line)[(address >> 5) ^ cacheline_mask]
            cacheline_addr ← address & 0xffffffe0
  
```



```

if F = 1 and cacheline.Dirty then
  for i = 0 .. C_DCACHE_LINE_LEN - 1 loop
    if cacheline.Valid[i] then
      Mem(cacheline_addr + i * 4) ← cacheline.Data[i]
  if T = 0 then
    cacheline.Tag ← 0
  else if cacheline.Address = cacheline_addr then
    cacheline.Tag ← 0
if E = 1 then
  if F = 1 then
    request external cache flush with address
  else
    request external cache invalidate with address

```

## Registers Altered

- ESR[EC], in case a privileged instruction exception is generated

## Latency

- 2 cycles for `wdc.clear`
- 2 cycles for `wdc` with `C_AREA_OPTIMIZED=1`
- 3 cycles for `wdc` with `C_AREA_OPTIMIZED=0`
- 2 + N cycles for `wdc.flush`, where N is the number of clock cycles required to flush the cache line to memory when necessary

## Note

The **wdc**, **wdc.flush** and **wdc.clear** instructions are independent of data cache enable (MSR[DCE]), and can be used either with the data cache enabled or disabled.

The **wdc.clear** instruction is intended to invalidate a specific area in memory, for example a buffer to be written by a Direct Memory Access device. Using this instruction ensures that other cache lines are not inadvertently invalidated, erroneously discarding data that has not yet been written to memory.

The address of the affected cache line is always the physical address, independent of the parameter `C_USE_MMU` and whether the MMU is in virtual mode or real mode.

When using **wdc.flush** in a loop to flush the entire cache, the loop can be optimized by using Ra as the cache base address and Rb as the loop counter:

```

addik    r5,r0,C_DCACHE_BASEADDR
addik    r6,r0,C_DCACHE_BYTE_SIZE-C_DCACHE_LINE_LEN*4
loop:   wdc.flush r5,r6
bgtid    r6,loop
addik    r6,r6,-C_DCACHE_LINE_LEN*4

```

When using **wdc.clear** in a loop to invalidate a memory area in the cache, the loop can be optimized by using Ra as the memory area base address and Rb as the loop counter:

```

addik    r5,r0,memory_area_base_address
addik    r6,r0,memory_area_byte_size-C_DCACHE_LINE_LEN*4
loop:   wdc.clear r5,r6
bgtid    r6,loop
addik    r6,r6,-C_DCACHE_LINE_LEN*4

```

## wic

### Write to Instruction Cache

wic                    rA,rB

1	0	0	1	0	0	0	0	0	0	0	rA	rB	0	0	0	0	1	1	0	1	0	0	0
0						6					1	1										3	
											1	6										1	

### Description

Write into the instruction cache tag to invalidate a cache line. The register rB value is not used. Register rA contains the address of the affected cache line.

When MicroBlaze is configured to use an MMU ( $C\_USE\_MMU \geq 1$ ) this instruction is privileged. This means that if the instruction is attempted in User Mode ( $MSR[UM] = 1$ ) a Privileged Instruction exception occurs.

### Pseudocode

```

if MSR[UM] = 1 then
    ESR[EC] ← 00111
else
    if C_ICACHE_LINE_LEN = 4 then
        cacheline_mask ← (1 << log2(C_CACHE_BYTE_SIZE) - 4) - 1
        (ICache Line)[((Ra) >> 4) ^ cacheline_mask].Tag ← 0
    if C_ICACHE_LINE_LEN = 8 then
        cacheline_mask ← (1 << log2(C_CACHE_BYTE_SIZE) - 5) - 1
        (ICache Line)[((Ra) >> 5) ^ cacheline_mask].Tag ← 0

```

### Registers Altered

- ESR[EC], in case a privileged instruction exception is generated

### Latency

- 2 cycles

### Note

The WIC instruction is independent of instruction cache enable ( $MSR[ICE]$ ), and can be used either with the instruction cache enabled or disabled.

The address of the affected cache line is the virtual address when the parameter  $C\_USE\_MMU = 3$  (VIRTUAL) and the MMU is in virtual mode, otherwise it is the physical address.

**XOR****Logical Exclusive OR****xor**      rD, rA, rB

1	0	0	0	1	0	rD	rA	rB	0	0	0	0	0	0	0	0	0	0
0					6	1	1	2										3
						1	6	1										1

**Description**

The contents of register rA are XORed with the contents of register rB; the result is placed into register rD.

**Pseudocode**

$$(rD) \leftarrow (rA) \oplus (rB)$$

**Registers Altered**

- rD

**Latency**

- 1 cycle

# xori

## Logical Exclusive OR with Immediate

**xori**            rD, rA, IMM

1	0	1	0	1	0	rD	rA	IMM
0					6	1	1	3
						1	6	1

### Description

The IMM field is extended to 32 bits by concatenating 16 0-bits on the left. The contents of register rA are XOR'ed with the extended IMM field; the result is placed into register rD.

### Pseudocode

$$(rD) \leftarrow (rA) \oplus \text{sext}(IMM)$$

### Registers Altered

- rD

### Latency

- 1 cycle

### Note

By default, Type B Instructions will take the 16-bit IMM field value and sign extend it to 32 bits to use as the immediate operand. This behavior can be overridden by preceding the Type B instruction with an imm instruction. See the instruction “imm,” page 204 for details on using 32-bit immediate values.

# Additional Resources

---

## EDK Documentation

The following documents are available in your EDK installation. You can also access the entire documentation set online at [http://www.xilinx.com/ise/embedded/edk\\_docs.htm](http://www.xilinx.com/ise/embedded/edk_docs.htm).

Relevant individual documents are linked below.

- [EDK Concepts, Tools, and Techniques \(UG683\)](#)  
Note: The accompanying design files are in [edk\\_ctt.zip](#).
- [Embedded System Tools Reference Manual \(UG111\)](#)
- [Platform Specification Format Reference Manual \(UG642\)](#)
- [XPS Help](#)
- [SDK Help](#)
- [PowerPC 405 Processor Reference Guide \(UG011\)](#)

## Additional Resources

The following lists some of the resources you can access directly using the provided URLs.

- The entire set of GNU manuals:  
<http://www.gnu.org/manual>
- Xilinx Data Sheets:  
[http://www.xilinx.com/support/documentation/data\\_sheets.htm](http://www.xilinx.com/support/documentation/data_sheets.htm)
- Xilinx Problem Solvers:  
<http://www.xilinx.com/support/troubleshoot/psolvers.htm>
- Xilinx ISE® Manuals:  
[http://www.xilinx.com/support/software\\_manuals.htm](http://www.xilinx.com/support/software_manuals.htm)
- Additional Xilinx Documentation:  
<http://www.xilinx.com/support/library.htm>
- Xilinx Glossary:  
[http://www.xilinx.com/support/documentation/sw\\_manuals/glossary.pdf](http://www.xilinx.com/support/documentation/sw_manuals/glossary.pdf)
- Xilinx Documentation:  
<http://www.xilinx.com/support/documentation>
- Xilinx Support:  
<http://www.xilinx.com/support>

