

LogiCORE IP Image Edge Enhancement v5.01a

Product Guide

PG003 October 16, 2012

Table of Contents

SECTION I: SUMMARY

IP Facts

Chapter 1: Overview

Overview	7
Feature Summary	7
Applications	8
Licensing and Ordering Information	8

Chapter 2: Product Specification

Standards	9
Performance	9
Resource Utilization	10
Core Interfaces and Register Space	12

Chapter 3: Designing with the Core

General Design Guidelines	27
Clock, Enable, and Reset Considerations	28
System Considerations	30

Chapter 4: C Model Reference

Features	32
Overview	32
Unpacking and Model Contents	33
Installation	34
Software Requirements	34
Using the C Model	35
C Model Example Code	39

SECTION II: VIVADO DESIGN SUITE

Chapter 5: Customizing and Generating the Core

Graphical User Interface	42
--------------------------------	----

Chapter 6: Constraining the Core

Required Constraints	45
Device, Package, and Speed Grade Selections	45
Clock Frequencies	45
Clock Management	46
Clock Placement	46
Banking	46
Transceiver Placement	46
I/O Standard and Placement	46

Chapter 7: Detailed Example Design

Demonstration Test Bench	47
--------------------------------	----

SECTION III: ISE DESIGN SUITE

Chapter 8: Customizing and Generating the Core

Graphical User Interface	54
Parameter Values in the XCO File	56
Output Generation	57

Chapter 9: Constraining the Core

Required Constraints	59
Device, Package, and Speed Grade Selections	59
Clock Frequencies	59
Clock Management	60
Clock Placement	60
Banking	60
Transceiver Placement	60
I/O Standard and Placement	60

Chapter 10: Detailed Example Design

Demonstration Test Bench	61
Test Bench Structure	61
Running the Simulation	62
Directory and File Contents	62

SECTION IV: APPENDICES

Appendix A: Verification, Compliance, and Interoperability

Simulation	65
Hardware Testing	65
Interoperability	66

Appendix B: Migrating

Appendix C: Debugging

Bringing up the AXI4-Lite Interface	69
Bringing up the AXI4-Stream Interfaces	70
Debugging Features	71
Evaluation Core Timeout	73
Interfacing to Third-Party IP	73

Appendix D: Application Software Development

Programmer Guide	75
------------------------	----

Appendix E: Additional Resources

Xilinx Resources	78
Solution Centers	78
References	78
Technical Support	79
Revision History	79
Notice of Disclaimer	79

SECTION I: SUMMARY

IP Facts

Overview

Product Specification

Designing with the Core

C Model Reference

Introduction

The Xilinx Image Edge Enhancement LogiCORE™ IP provides users with an easy-to-use IP block to enhance the edges of objects within each frame of video. The core provides a set of standard Sobel and Laplacian filters with programmable gain that adjust the strength of the edge enhancement effect.

Features

- Programmable gain for edge directions
- YCbCr 4:4:4 input and output
- AXI4-Stream data interfaces
- Optional AXI4-Lite control interface
- Supports 8, 10, and 12-bits per color component input and output
- Built-in, optional bypass and test-pattern generator mode
- Built-in, optional throughput monitors
- Supports spatial resolutions from 32x32 up to 7680x7680
 - Supports 1080P60 in all supported device families (1)
 - Supports 4kx2k @ 24 Hz in supported high performance devices

1. Performance on low power devices may be lower.

LogiCORE IP Facts Table	
Core Specifics	
Supported Device Family ⁽¹⁾	Zynq™-7000 ⁽²⁾ , Artix™-7, Virtex®-7, Kintex®-7, Virtex-6, Spartan®-6
Supported User Interfaces	AXI4-Lite, AXI4-Stream ⁽³⁾
Resources	See Table 2-1 through Table 2-4 .
Provided with Core	
Documentation	Product Guide
Design Files	ISE: NGC netlist, Encrypted HDL Vivado: Encrypted RTL
Example Design	Not Provided
Test Bench	Verilog ⁽⁴⁾
Constraints File	Not Provided
Simulation Models	VHDL or Verilog Structural, C-Model ⁽⁴⁾
Supported Software Drivers	Not Applicable
Tested Design Flows	
Design Entry Tools	CORE Generator™ 14.3 tool, Vivado™ 2012.3 Design Suite ⁽⁶⁾ , Platform Studio (XPS)
Simulation ⁽⁵⁾	Mentor Graphics ModelSim, Xilinx® ISim
Synthesis Tools	Xilinx Synthesis Technology (XST) Vivado Synthesis
Support	
Provided by Xilinx, Inc.	

1. For a complete listing of supported devices, see the [release notes](#) for this core.
2. Supported in ISE Design Suite implementations only.
3. Video protocol as defined in the *Video IP: AXI Feature Adoption* section of the (UG761) *AXI Reference Guide [Ref 1]*.
4. HDL test bench and C Model available on the product page on Xilinx.com at <http://www.xilinx.com/products/intellectual-property/EF-DI-IMG-ENHANCE.htm>.
5. For the supported versions of the tools, see the [ISE Design Suite 14: Release Notes Guide](#).
6. Supports only 7 series devices.

Overview

Overview

The edge enhancement core combines the outputs of Sobel and Laplacian operators with the original image to emphasize edge content, as shown in [Figure 1-1](#).

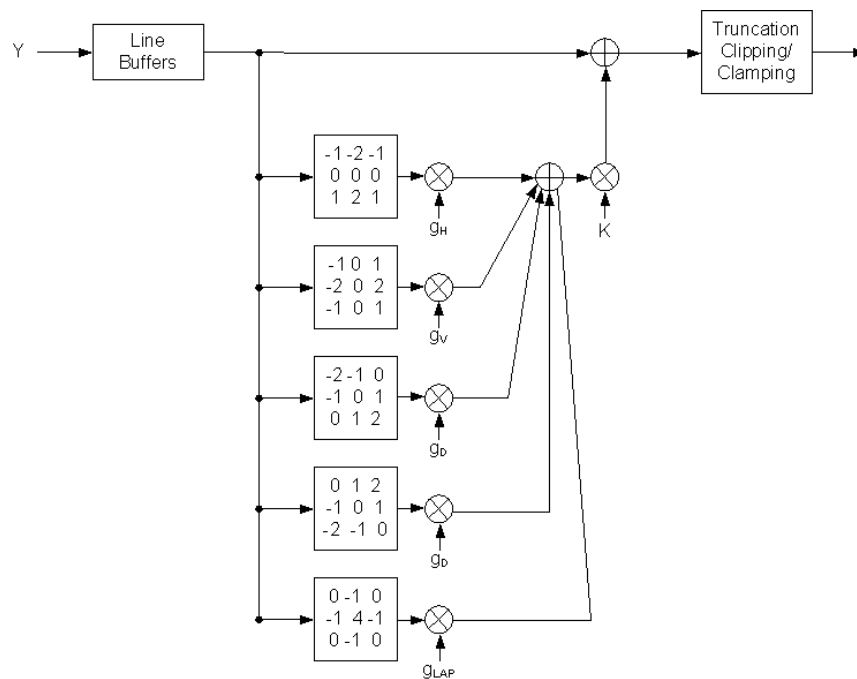

Figure 1-1: Image Edge Enhancement

Feature Summary

The Image Edge Enhancement core uses Sobel and Laplacian filters to enhance edges of objects. There is a programmable gain for each filter to adjust the strength of the edge enhancement effect. This core works on YCbCr 4:4:4 data. The core is capable of a maximum resolution of 7680 columns by 7680 rows with 8, 10, or 12 bits per pixel and supports the bandwidth necessary for High-definition (1080p60) resolutions in all Xilinx FPGA device families. Higher resolutions can be supported in Xilinx high-performance device families.

You can configure and instantiate the core from CORE Generator or EDK tools. Core functionality may be controlled dynamically with an optional AXI4-Lite interface.

Applications

- Pre-processing block for image sensors
 - Video surveillance
 - Industrial imaging
 - Video conferencing
 - Machine vision
 - Other imaging applications
-

Licensing and Ordering Information

This Xilinx LogiCORE IP module is provided under the terms of the [Xilinx Core License Agreement](#). The module is shipped as part of the Vivado Design Suite/ISE Design Suite. For full access to all core functionalities in simulation and in hardware, you must purchase a license for the core. Contact your [local Xilinx sales representative](#) for information about pricing and availability.

For more information, visit the Image Edge Enhancement product web page.

Information about other Xilinx LogiCORE IP modules is available at the [Xilinx Intellectual Property](#) page. For information on pricing and availability of other Xilinx LogiCORE IP modules and tools, contact your [local Xilinx sales representative](#).

Product Specification

Standards

The Image Edge Enhancement core is compliant with the AXI4-Stream Video Protocol and AXI4-Lite interconnect standards. Refer to the *Video IP: AXI Feature Adoption* section of the (UG761) *AXI Reference Guide* [Ref 1] for additional information.

Performance

The following sections detail the performance characteristics of the Image Edge Enhancement core.

Maximum Frequencies

This section contains typical clock frequencies for the target devices. The maximum achievable clock frequency can vary. The maximum achievable clock frequency and all resource counts can be affected by other tool options, additional logic in the FPGA device, using a different version of Xilinx tools and other factors. Refer to in [Table 2-1](#) through [Table 2-8](#) for device-specific information.

Latency

The propagation delay of the Image Edge Enhancement core is one full scan line and 19 video clock cycles.

Throughput

The Image Edge Enhancement core produces one output pixel per input sample.

The core supports bidirectional data throttling between its AXI4-Stream Slave and Master interfaces. If the slave side data source is not providing valid data samples (`s_axis_video_tvalid` is not asserted), the core cannot produce valid output samples after its internal buffers are depleted. Similarly, if the master side interface is not ready to

accept valid data samples (`m_axis_video_tready` is not asserted) the core cannot accept valid input samples once its buffers become full.

If the master interface is able to provide valid samples (`s_axis_video_tvalid` is high) and the slave interface is ready to accept valid samples (`m_axis_video_tready` is high), typically the core can process one sample and produce one pixel per `ACLK` cycle.

However, at the end of each scan line the core flushes internal pipelines for 19 clock cycles, during which the `s_axis_video_tready` is de-asserted signaling that the core is not ready to process samples. Also at the end of each frame the core flushes internal line buffers for 1 scan line, during which the `s_axis_video_tready` is de-asserted signaling that the core is not ready to process samples.

When the core is processing timed streaming video (which is typical for most video systems), the flushing periods coincide with the blanking periods therefore do not reduce the throughput of the system.

When the core is processing data from a video source which can always provide valid data, e.g. a frame buffer, the throughput of the core can be defined as follows:

$$R_{MAX} = f_{ACLK} \times \frac{ROWS}{ROWS+1} \times \frac{COLS}{COLS+19} \quad \text{Equation 2-1}$$

In numeric terms, 1080P/60 represents an average data rate of 124.4 MPixels/second (1080 rows x 1920 columns x 60 frames / second), and a burst data rate of 148.5 MPixels/sec.

To ensure that the core can process 124.4 MPixels/second, it needs to operate minimally at:

$$f_{ACLK} = R_{MAX} \times \frac{ROWS+1}{ROWS} \times \frac{COLS+19}{COLS} = 124.4 \times \frac{1081}{1080} \times \frac{1939}{1920} = 125.4 \quad \text{Equation 2-2}$$

Resource Utilization

For an accurate measure of the usage of primitives, slices, and CLBs for a particular instance, check the **Display Core Viewer after Generation**.

Resource Utilization using Vivado Design Suite

The information presented in [Table 2-1](#) through [Table 2-3](#) is a guide to the resource utilization and maximum clock frequency of the Image Edge Enhancement core for all input/output width combinations for Virtex-7, Kintex-7, Artix-7 FPGA families using the Vivado Design Suite. This core does not use any dedicated I/O or CLK resources. The design was tested with the AXI4-Lite interface, `INTC_IF` and the Debug Features disabled. By default, the maximum number of pixels per scan line was set to 1920, active pixels per scan line was set to 1920.

Table 2-1: Kintex-7

Data Width	LUT-FF Pairs	LUTs	FFs	RAM 36 / 18	DSP48S	Fmax (MHz)
8	1113	741	1083	2	1	274
10	1247	879	1308	5	1	266
12	1468	1039	1500	12	1	266

Device, Part, Speed: XC7K70T,FBG484, -1 (ADVANCED 1.07b 2012-08-28)

Table 2-2: Artix-7

Data Width	LUT-FF Pairs	LUTs	FFs	RAM 36 / 18	DSP48S	Fmax (MHz)
8	1002	735	1083	2	1	188
10	1305	879	1308	5	1	188
12	1457	1037	1500	12	1	188

Device, Part, Speed: XC7A100T,FGG484, -1 (ADVANCED 1.05a 2012-08-31)

Table 2-3: Virtex-7

Data Width	LUT-FF Pairs	LUTs	FFs	RAM 36 / 18	DSP48S	Fmax (MHz)
8	1095	739	1083	2	1	281
10	1284	877	1308	5	1	266
12	1515	1036	1500	12	1	266

Device, Part, Speed: XC7V585T,FFG1157, -1 (ADVANCED 1.07b 2012-08-28)

Resource Utilization using ISE Design Suite

The information presented in [Table 2-4](#) through [Table 2-8](#) is a guide to the resource utilization and maximum clock frequency of the Image Edge Enhancement core for all input/output width combinations for Virtex-7, Kintex-7, Artix-7, Zynq-7000, Virtex-6, and Spartan-6 FPGA families. The design was tested using ISE[®] v14.3 tools with default tool options for characterization data. This core does not use any dedicated I/O or CLK resources. The design was tested with the AXI4-Lite interface, `INTC_IF` and the Debug Features disabled. By default, the maximum number of pixels per scan line was set to 1920, active pixels per scan line was set to 1920.

Table 2-4: Artix-7 and Zynq-7000 Devices with Artix Based Fabric

Data Width	LUT-FF Pairs	LUTs	FFs	RAM 36 / 18	DSP48E1	Fmax (MHz)
8	1069	900	975	2/1	1	204
10	1166	1026	1149	5/0	1	196
12	1412	1158	1323	12/0	1	204

Device, Part, Speed: XC7A100T,FGG484, -1 (ADVANCED 1.05d 2012-09-11)

Table 2-5: Kintex-7 and Zynq-7000 Devices with Kintex Based Fabric

Data Width	LUT-FF Pairs	LUTs	FFs	RAM 36 / 18	DSP48E1	Fmax (MHz)
8	1054	890	975	2/1	1	296
10	1209	1000	1149	5/0	1	266
12	1413	1138	1323	12/0	1	281

Device, Part, Speed: XC7K70T,FBG484, -1 (ADVANCED 1.07c 2012-09-11)

Table 2-6: Virtex-7

Data Width	LUT-FF Pairs	LUTs	FFs	RAM 36 / 18	DSP48E1	Fmax (MHz)
8	1065	875	975	2/1	1	258
10	1210	1014	1149	5/0	1	288
12	1328	1155	1323	12/0	1	266

Device, Part, Speed: XC7V585T,FFG1157, -1 (ADVANCED 1.07c 2012-09-11)

Table 2-7: Virtex-6

Data Width	LUT-FF Pairs	LUTs	FFs	RAM 36 / 18	DSP48E1	Fmax (MHz)
8	1020	904	975	2/1	1	281
10	1204	1010	1149	5/0	1	281
12	1292	1167	1323	12/0	1	266

Device, Part, Speed: XC6VLX75T,FF484, -1 (PRODUCTION 1.17 2012-09-11)

Table 2-8: Spartan-6

Data Width	LUT-FF Pairs	LUTs	FFs	RAM 16 / 8	DSP48A1	Fmax (MHz)
8	1113	910	1025	5/0	1	180
10	1238	1047	1211	9/1	2	110
12	1481	1141	1395	24/0	2	110

Device, Part, Speed: XC6SLX25,FGG484, -2 (PRODUCTION 1.23a 2012-09-11)

Core Interfaces and Register Space

Port Descriptions

The Image Edge Enhancement core uses industry standard control and data interfaces to connect to other system components. The following sections describe the various interfaces available with the core. Figure 2-1 illustrates an I/O diagram of the Image Edge Enhancement core. Some signals are optional and not present for all configurations of the core. The AXI4-Lite interface and the IRQ pin are present only when the core is configured

via the GUI with an AXI4-Lite control interface. The `INTC_IF` interface is present only when the core is configured via the GUI with the INTC interface enabled.

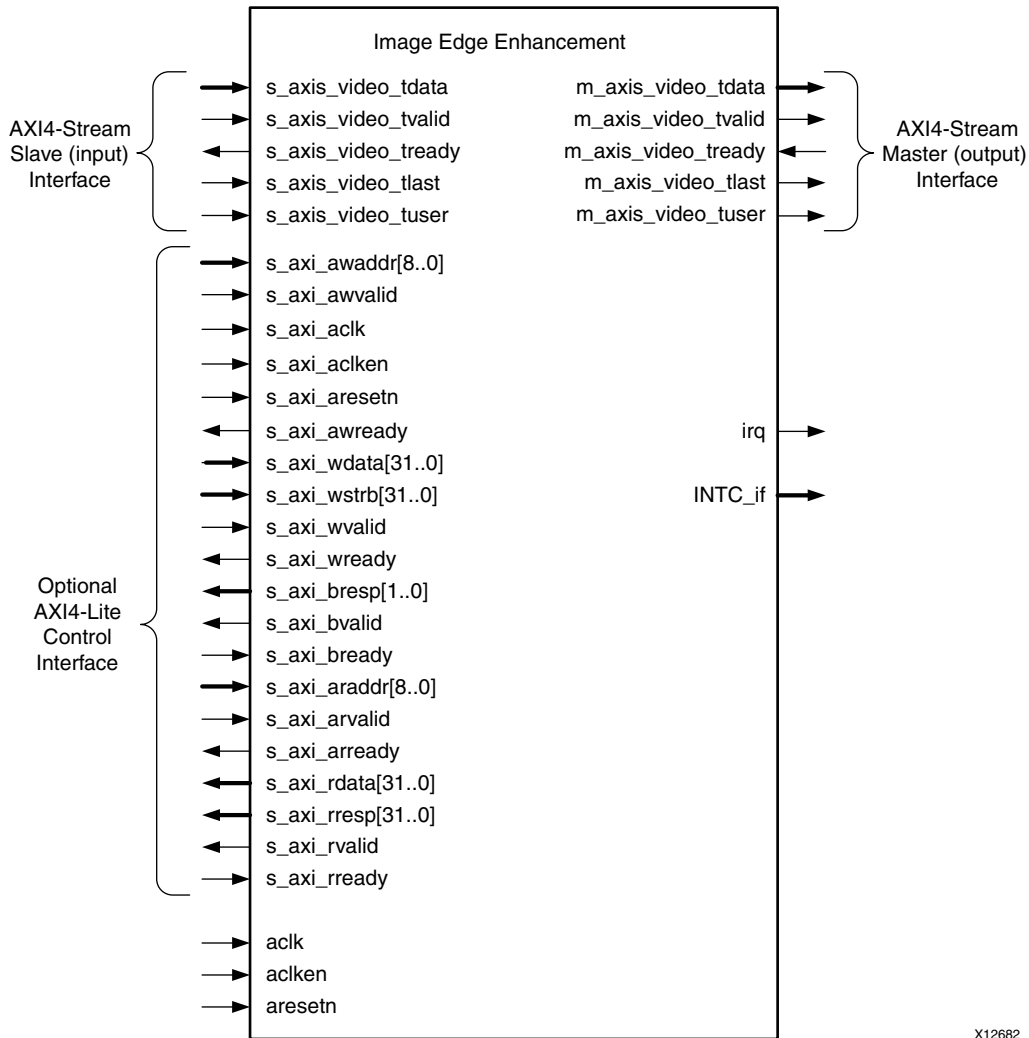

Figure 2-1: Image Edge Enhancement Core Top-Level Signaling Interface

Common Interface Signals

Table 2-9 summarizes the signals which are either shared by, or not part of the dedicated AXI4-Stream data or AXI4-Lite control interfaces.

Table 2-9: Common Interface Signals

Signal Name	Direction	Width	Description
ACLK	In	1	Video Core Clock
ACLKEN	In	1	Video Core Active High Clock Enable
ARESETn	In	1	Video Core Active Low Synchronous Reset

Table 2-9: Common Interface Signals

Signal Name	Direction	Width	Description
INTC_IF	Out	9	Optional External Interrupt Controller Interface. Available only when INTC_IF is selected on GUI.
IRQ	Out	1	Optional Interrupt Request Pin. Available only when AXI4-Lite interface is selected on GUI.

The `ACLK`, `ACLKEN` and `ARESETn` signals are shared between the core and the AXI4-Stream data interfaces. The AXI4-Lite control interface has its own set of clock, clock enable and reset pins: `S_AXI_ACLK`, `S_AXI_ACLKEN` and `S_AXI_ARESETn`. Refer to [The Interrupt Subsystem](#) for a detailed description of the `INTC_IF` and `IRQ` pins.

ACLK

The AXI4-Stream interface must be synchronous to the core clock signal `ACLK`. All AXI4-Stream interface input signals are sampled on the rising edge of `ACLK`. All AXI4-Stream output signal changes occur after the rising edge of `ACLK`. The AXI4-Lite interface is unaffected by the `ACLK` signal.

ACLKEN

The `ACLKEN` pin is an active-high, synchronous clock-enable input pertaining to AXI4-Stream interfaces. Setting `ACLKEN` low (de-asserted) halts the operation of the core despite rising edges on the `ACLK` pin. Internal states are maintained, and output signal levels are held until `ACLKEN` is asserted again. When `ACLKEN` is de-asserted, core inputs are not sampled, except `ARESETn`, which supersedes `ACLKEN`. The AXI4-Lite interface is unaffected by the `ACLKEN` signal.

ARESETn

The `ARESETn` pin is an active-low, synchronous reset input pertaining to only AXI4-Stream interfaces. `ARESETn` supersedes `ACLKEN`, and when set to 0, the core resets at the next rising edge of `ACLK` even if `ACLKEN` is de-asserted. The `ARESETn` signal must be synchronous to the `ACLK` and must be held low for a minimum of 32 clock cycles of the slowest clock. The AXI4-Lite interface is unaffected by the `ARESETn` signal.

Data Interface

The Image Edge Enhancement core receives and transmits data using AXI4-Stream interfaces that implement a video protocol as defined in the *Video IP: AXI Feature Adoption* section of the *AXI Reference Guide* (UG761) [\[Ref 1\]](#).

AXI4-Stream Signal Names and Descriptions

[Table 2-10](#) describes the AXI4-Stream signal names and descriptions.

Table 2-10: AXI4-Stream Data Interface Signal Descriptions

Signal Name	Direction	Width	Description
s_axis_video_tdata	In	24, 32, 40	Input Video Data
s_axis_video_tvalid	In	1	Input Video Valid Signal
s_axis_video_tready	Out	1	Input Ready
s_axis_video_tuser	In	1	Input Video Start Of Frame
s_axis_video_tlast	In	1	Input Video End Of Line
m_axis_video_tdata	Out	24, 32, 40	Output Video Data
m_axis_video_tvalid	Out	1	Output Valid
m_axis_video_tready	In	1	Output Ready
m_axis_video_tuser	Out	1	Output Video Start Of Frame
m_axis_video_tlast	Out	1	Output Video End Of Line

Video Data

The AXI4-Stream interface specification restricts TDATA widths to integer multiples of 8 bits. Therefore, 10 and 12 bit data must be padded with zeros on the MSB to form 32 or 40 bit wide vectors before connecting to s_axis_video_tdata. Padding does not affect the size of the core.

Similarly, YCbCr data on the Image Edge Enhancement output m_axis_video_tdata is packed and padded to multiples of 8 bits as necessary, as seen in Figure 2-2. Zero padding the most significant bits is only necessary for 10 and 12 bit wide data.

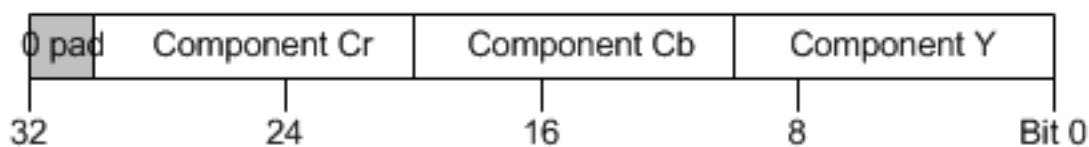

Figure 2-2: YCbCr 4:4:4 Data Encoding on s_axis_video_data and m_axis_video_data

READY/VALID Handshake

A valid transfer occurs whenever READY, VALID, ACLKEN, and ARESETn are high at the rising edge of ACLK, as seen in Figure 2-3. During valid transfers, DATA only carries active video data. Blank periods and ancillary data packets are not transferred via the AXI4-Stream video protocol.

Guidelines on Driving s_axis_video_tvalid

Once `s_axis_video_tvalid` is asserted, no interface signals (except the Image Edge Enhancement core driving `s_axis_video_tready`) may change value until the transaction completes (`s_axis_video_tready` and `s_axis_video_tvalid` `ACLKEN` are high on the rising edge of `ACLK`). Once asserted, `s_axis_video_tvalid` may only be de-asserted after a transaction has completed. Transactions may not be retracted or aborted. In any cycle following a transaction, `s_axis_video_tvalid` can either be de-asserted or remain asserted to initiate a new transfer.

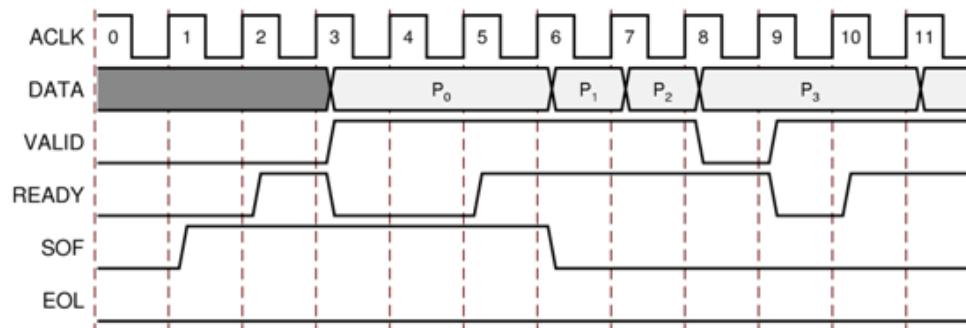

Figure 2-3: Example of READY/VALID Handshake, Start of a New Frame

Guidelines on Driving m_axis_video_tready

The `m_axis_video_tready` signal may be asserted before, during or after the cycle in which the Image Edge Enhancement core asserted `m_axis_video_tvalid`. The assertion of `m_axis_video_tready` may be dependent on the value of `m_axis_video_tvalid`. A slave that can immediately accept data qualified by `m_axis_video_tvalid`, should pre-assert its `m_axis_video_tready` signal until data is received. Alternatively, `m_axis_video_tready` can be registered and driven the cycle following `VALID` assertion.



RECOMMENDED: *The AXI4-Stream slave should drive READY independently, or pre-assert READY to minimize latency.*

Start of Frame Signals - m_axis_video_tuser, s_axis_video_tuser

The Start-Of-Frame (SOF) signal, physically transmitted over the AXI4-Stream `TUSER0` signal, marks the first pixel of a video frame. The SOF pulse is 1 valid transaction wide, and must coincide with the first pixel of the frame, as seen in Figure 2-3. SOF serves as a frame synchronization signal, which allows downstream cores to re-initialize, and detect the first pixel of a frame. The SOF signal may be asserted an arbitrary number of `ACLK` cycles before the first pixel value is presented on `DATA`, as long as a `VALID` is not asserted.

End of Line Signals - `m_axis_video_tlast`, `s_axis_video_tlast`

The End-Of-Line signal, physically transmitted over the AXI4-Stream TLAST signal, marks the last pixel of a line. The EOL pulse is 1 valid transaction wide, and must coincide with the last pixel of a scan-line, as seen in Figure 2-4.

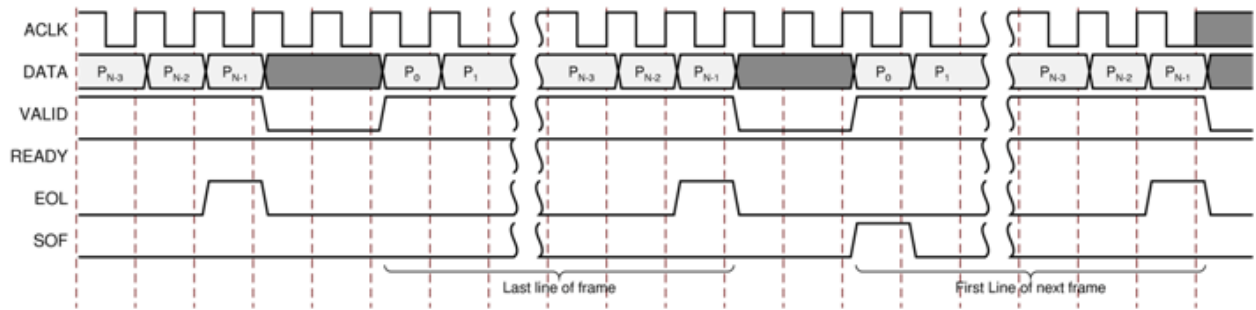

Figure 2-4: Use of EOL and SOF Signals

Control Interface

When configuring the core, the user has the option to add an AXI4-Lite register interface to dynamically control the behavior of the core. The AXI4-Lite slave interface facilitates integrating the core into a processor system, or along with other video or AXI4-Lite compliant IP, connected via AXI4-Lite interface to an AXI4-Lite master. In a static configuration with a fixed set of parameters (constant configuration), the core can be instantiated without the AXI4-Lite control interface, which reduces the core Slice footprint.

Constant Configuration

The constant configuration caters to users who will interface the core to a particular image sensor with a known, stationary resolution and use constant enhancement filter gains. In constant configuration the image resolution (number of active pixels per scan line and the number of active scan lines per frame) and the enhancement filter gains are hard coded into the core via the Image Edge Enhancement core GUI. Since there is no AXI4-Lite interface, the core is not programmable, but can be reset, enabled, or disabled using the `ARESETn` and `ACLKEN` ports.

AXI4-Lite Interface

The AXI4-Lite interface allows a user to dynamically control parameters within the core. Core configuration can be accomplished using an AXI4-Stream master state machine, or an embedded ARM or soft system processor such as MicroBlaze.

The Image Edge Enhancement core can be controlled via the AXI4-Lite interface using read and write transactions to the Image Edge Enhancement register space.

Table 2-11: AXI4-Lite Interface Signals

Signal Name	Direction	Width	Description
s_axi_aclk	In	1	AXI4-Lite clock
s_axi_aclken	In	1	AXI4-Lite clock enable
s_axi_aresetn	In	1	AXI4-Lite synchronous Active Low reset
s_axi_awvalid	In	1	AXI4-Lite Write Address Channel Write Address Valid.
s_axi_awread	Out	1	AXI4-Lite Write Address Channel Write Address Ready. Indicates DMA ready to accept the write address.
s_axi_awaddr	In	32	AXI4-Lite Write Address Bus
s_axi_wvalid	In	1	AXI4-Lite Write Data Channel Write Data Valid.
s_axi_wready	Out	1	AXI4-Lite Write Data Channel Write Data Ready. Indicates DMA is ready to accept the write data.
s_axi_wdata	In	32	AXI4-Lite Write Data Bus
s_axi_bresp	Out	2	AXI4-Lite Write Response Channel. Indicates results of the write transfer.
s_axi_bvalid	Out	1	AXI4-Lite Write Response Channel Response Valid. Indicates response is valid.
s_axi_bready	In	1	AXI4-Lite Write Response Channel Ready. Indicates target is ready to receive response.
s_axi_arvalid	In	1	AXI4-Lite Read Address Channel Read Address Valid
s_axi_arready	Out	1	Ready. Indicates DMA is ready to accept the read address.
s_axi_araddr	In	32	AXI4-Lite Read Address Bus
s_axi_rvalid	Out	1	AXI4-Lite Read Data Channel Read Data Valid
s_axi_rready	In	1	AXI4-Lite Read Data Channel Read Data Ready. Indicates target is ready to accept the read data.
s_axi_rdata	Out	32	AXI4-Lite Read Data Bus
s_axi_rresp	Out	2	AXI4-Lite Read Response Channel Response. Indicates results of the read transfer.

S_AXI_ACLK

The AXI4-Lite interface must be synchronous to the S_AXI_ACLK clock signal. The AXI4-Lite interface input signals are sampled on the rising edge of ACLK. The AXI4-Lite output signal changes occur after the rising edge of ACLK. The AXI4-Stream interfaces signals are not affected by the S_AXI_ACLK.

S_AXI_ACLKEN

The S_AXI_ACLKEN pin is an active-high, synchronous clock-enable input for the AXI4-Lite interface. Setting S_AXI_ACLKEN low (de-asserted) halts the operation of the AXI4-Lite interface despite rising edges on the S_AXI_ACLK pin. AXI4-Lite interface states are

maintained, and AXI4-Lite interface output signal levels are held until `S_AXI_ACLKEN` is asserted again. When `S_AXI_ACLKEN` is de-asserted, AXI4-Lite interface inputs are not sampled, except `S_AXI_ARESETn`, which supersedes `S_AXI_ACLKEN`. The AXI4-Stream interfaces signals are not affected by the `S_AXI_ACLKEN`.

S_AXI_ARESETn

The `S_AXI_ARESETn` pin is an active-low, synchronous reset input for the AXI4-Lite interface. `S_AXI_ARESETn` supersedes `S_AXI_ACLKEN`, and when set to 0, the core resets at the next rising edge of `S_AXI_ACLK` even if `S_AXI_ACLKEN` is de-asserted. The `S_AXI_ARESETn` signal must be synchronous to the `S_AXI_ACLK` and must be held low for a minimum of 32 clock cycles of the slowest clock. The `S_AXI_ARESETn` input is resynchronized to the `ACLK` clock domain. The AXI4-Stream interfaces and core signals are also reset by `S_AXI_ARESETn`.

Register Space

The standardized Xilinx Video IP register space is partitioned into control-, timing-, and core specific registers. The Image Edge Enhancement core uses only one timing related register, `ACTIVE_SIZE` (0x0020), which allows specifying the input frame dimensions. Also, the core has four core-specific register, `GAIN_H` (0x0100), `GAIN_V` (0x0104), `GAIN_D` (0x0108), and `GAIN_LAP` (0x010C) which allows specifying the gain of the enhancement filters.

Table 2-12: Register Names and Descriptions

Address (hex) BASEADDR +	Register Name	Access Type	Double Buffered	Default Value	Register Description
0x0000	CONTROL	R/W	No	Power-on-Reset : 0x0	Bit 0: SW_ENABLE Bit 1: REG_UPDATE Bit 4: BYPASS ⁽¹⁾ Bit 5: TEST_PATTERN ⁽¹⁾ Bit 30: FRAME_SYNC_RESET (1: reset) Bit 31: SW_RESET (1: reset)
0x0004	STATUS	R/W	No	0	Bit 0: PROC_STARTED Bit 1: EOF Bit 16: SLAVE_ERROR
0x0008	ERROR	R/W	No	0	Bit 0: SLAVE_EOL_EARLY Bit 1: SLAVE_EOL_LATE Bit 2: SLAVE_SOF_EARLY Bit 3: SLAVE_SOF_LATE
0x000C	IRQ_ENABLE	R/W	No	0	16-0: Interrupt enable bits corresponding to STATUS bits

Table 2-12: Register Names and Descriptions (Cont'd)

Address (hex) BASEADDR +	Register Name	Access Type	Double Buffered	Default Value	Register Description
0x0010	VERSION	R	N/A	0x0500A001	7-0: REVISION_NUMBER 11-8: PATCH_ID 15-12: VERSION_REVISION 23-16: VERSION_MINOR 31-24: VERSION_MAJOR
0x0014	SYSDEBUG0	R	N/A	0	0-31: Frame Throughput monitor ⁽¹⁾
0x0018	SYSDEBUG1	R	N/A	0	0-31: Line Throughput monitor ⁽¹⁾
0x001C	SYSDEBUG2	R	N/A	0	0-31: Pixel Throughput monitor ⁽¹⁾
0x0020	ACTIVE_SIZE	R/W	Yes	Specified via GUI	12-0: Number of Active Pixels per Scanline 28-16: Number of Active Lines per Frame
0x0100	GAIN_H	R/W	Yes	Specified via GUI	Allowed values are 0 to 2 in increments of 1/4 represented by four unsigned bits with two integer bits and two fractional bits
0x0104	GAIN_V	R/W	Yes	Specified via GUI	
0x0108	GAIN_D	R/W	Yes	Specified via GUI	
0x010C	GAIN_LAP	R/W	Yes	Specified via GUI	

1. Only available when the debugging features option is enabled in the GUI at the time the core is instantiated.

CONTROL (0x0000) Register

Bit 0 of the CONTROL register, SW_ENABLE, facilitates enabling and disabling the core from software. Writing '0' to this bit effectively disables the core halting further operations, which blocks the propagation of all video signals. After Power up, or Global Reset, the SW_ENABLE defaults to 0 for the AXI4-Lite interface. Similar to the ACLKEN pin, the SW_ENABLE flag is not synchronized with the AXI4-Stream interfaces: Enabling or Disabling the core takes effect immediately, irrespective of the core processing status. Disabling the core for extended periods may lead to image tearing.

Bit 1 of the CONTROL register, REG_UPDATE is a write done semaphore for the host processor, which facilitates committing all user and timing register updates simultaneously. The Image Edge Enhancement core ACTIVE_SIZE and GAIN registers are double buffered. One set of registers (the processor registers) is directly accessed by the processor interface, while the other set (the active set) is actively used by the core. New values written to the processor registers will get copied over to the active set at the end of the AXI4-Stream frame, if and only if REG_UPDATE is set. Setting REG_UPDATE to 0 before updating multiple

register values, then setting `REG_UPDATE` to 1 when updates are completed ensures all registers are updated simultaneously at the frame boundary without causing image tearing.

Bit 4 of the `CONTROL` register, `BYPASS`, switches the core to bypass mode if debug features are enabled. In bypass mode the Image Edge Enhancement core processing function is bypassed, and the core repeats AXI4-Stream input samples on its output. Refer to [Debugging Features in Appendix C](#) for more information. If debug features were not included at instantiation, this flag has no effect on the operation of the core. Switching bypass mode on or off is not synchronized to frame processing, therefore can lead to image tearing.

Bit 5 of the `CONTROL` register, `TEST_PATTERN`, switches the core to test-pattern generator mode if debug features are enabled. Refer to [Debugging Features in Appendix C](#) for more information. If debug features were not included at instantiation, this flag has no effect on the operation of the core. Switching test-pattern generator mode on or off is not synchronized to frame processing, therefore can lead to image tearing.

Bits 30 and 31 of the `CONTROL` register, `FRAME_SYNC_RESET` and `SW_RESET` facilitate software reset. Setting `SW_RESET` reinitializes the core to GUI default values, all internal registers and outputs are cleared and held at initial values until `SW_RESET` is set to 0. The `SW_RESET` flag is not synchronized with the AXI4-Stream interfaces. Resetting the core while frame processing is in progress will cause image tearing. For applications where the soft-ware reset functionality is desirable, but image tearing has to be avoided a frame synchronized software reset (`FRAME_SYNC_RESET`) is available. Setting `FRAME_SYNC_RESET` to 1 will reset the core at the end of the frame being processed, or immediately if the core is between frames when the `FRAME_SYNC_RESET` was asserted. After reset, the `FRAME_SYNC_RESET` bit is automatically cleared, so the core can get ready to process the next frame of video as soon as possible. The default value of both `RESET` bits is 0. Core instances with no AXI4-Lite control interface can only be reset via the `ARESETn` pin.

STATUS (0x0004) Register

All bits of the `STATUS` register can be used to request an interrupt from the host processor. To facilitate identification of the interrupt source, bits of the `STATUS` register remain set after an event associated with the particular `STATUS` register bit, even if the event condition is not present at the time the interrupt is serviced.

Bits of the `STATUS` register can be cleared individually by writing '1' to the bit position.

Bit 0 of the `STATUS` register, `PROC_STARTED`, indicates that processing of a frame has commenced via the AXI4-Stream interface.

Bit 1 of the `STATUS` register, End-of-frame (EOF), indicates that the processing of a frame has completed.

Bit 16 of the `STATUS` register, `SLAVE_ERROR`, indicates that one of the conditions monitored by the `ERROR` register has occurred.

ERROR (0x0008) Register

Bit 16 of the `STATUS` register, `SLAVE_ERROR`, indicates that one of the conditions monitored by the `ERROR` register has occurred. This bit can be used to request an interrupt from the host processor. To facilitate identification of the interrupt source, bits of the `STATUS` and `ERROR` registers remain set after an event associated with the particular `ERROR` register bit, even if the event condition is not present at the time the interrupt is serviced.

Bits of the `ERROR` register can be cleared individually by writing '1' to the bit position to be cleared.

Bit 0 of the `ERROR` register, `EOL_EARLY`, indicates an error during processing a video frame via the AXI4-Stream slave port. The number of pixels received between the latest and the preceding End-Of-Line (EOL) signal was less than the value programmed into the `ACTIVE_SIZE` register.

Bit 1 of the `ERROR` register, `EOL_LATE`, indicates an error during processing a video frame via the AXI4-Stream slave port. The number of pixels received between the last EOL signal surpassed the value programmed into the `ACTIVE_SIZE` register.

Bit 2 of the `ERROR` register, `SOF_EARLY`, indicates an error during processing a video frame via the AXI4-Stream slave port. The number of pixels received between the latest and the preceding Start-Of-Frame (SOF) signal was less than the value programmed into the `ACTIVE_SIZE` register.

Bit 3 of the `ERROR` register, `SOF_LATE`, indicates an error during processing a video frame via the AXI4-Stream slave port. The number of pixels received between the last SOF signal surpassed the value programmed into the `ACTIVE_SIZE` register.

IRQ_ENABLE (0x000C) Register

Any bits of the `STATUS` register can generate a host-processor interrupt request via the `IRQ` pin. The Interrupt Enable register facilitates selecting which bits of `STATUS` register will assert `IRQ`. Bits of the `STATUS` registers are masked by (AND) corresponding bits of the `IRQ_ENABLE` register and the resulting terms are combined (OR) together to generate `IRQ`.

Version (0x0010) Register

Bit fields of the Version Register facilitate software identification of the exact version of the hardware peripheral incorporated into a system. The core driver can take advantage of this Read-Only value to verify that the software is matched to the correct version of the hardware. See [Table 2-12](#) for details.

SYSDEBUG0 (0x0014) Register

The `SYSDEBUG0`, or Frame Throughput Monitor, register indicates the number of frames processed since power-up or the last time the core was reset. The `SYSDEBUG` registers can be useful to identify external memory / Frame buffer / or throughput bottlenecks in a video system. Refer to [Debugging Features in Appendix C](#) for more information.

SYSDEBUG1 (0x0018) Register

The `SYSDEBUG1`, or Line Throughput Monitor, register indicates the number of lines processed since power-up or the last time the core was reset. The `SYSDEBUG` registers can be useful to identify external memory / Frame buffer / or throughput bottlenecks in a video system. Refer to [Debugging Features in Appendix C](#) for more information.

SYSDEBUG2 (0x001C) Register

The `SYSDEBUG2`, or Pixel Throughput Monitor, register indicates the number of pixels processed since power-up or the last time the core was reset. The `SYSDEBUG` registers can be useful to identify external memory / Frame buffer / or throughput bottlenecks in a video system. Refer to [Debugging Features in Appendix C](#) for more information.

ACTIVE_SIZE (0x0020) Register

The `ACTIVE_SIZE` register encodes the number of active pixels per scan line and the number of active scan lines per frame. The lower half-word (bits 12:0) encodes the number of active pixels per scan line. Supported values are between 32 and the value provided in the **Maximum number of pixels per scan line** field in the GUI. The upper half-word (bits 28:16) encodes the number of active lines per frame. Supported values are 32 to 7680. To avoid processing errors, the user should restrict values written to `ACTIVE_SIZE` to the range supported by the core instance.

GAIN_H (0x0100) Register

The `GAIN_H` register contains the gain applied to the Horizontal Sobel filter. Allowed values are from 0 to 2 in increments of 1/4 represented by four unsigned bits with two integer bits and two fractional bits.

GAIN_V (0x0104) Register

The `GAIN_V` register contains the gain applied to the Vertical Sobel filter. Allowed values are from 0 to 2 in increments of 1/4 represented by four unsigned bits with two integer bits and two fractional bits.

GAIN_D (0x0108) Register

The GAIN_D register contains the gain applied to the left and right Diagonal Sobel filters. Allowed values are from 0 to 2 in increments of 1/4 represented by four unsigned bits with two integer bits and two fractional bits.

GAIN_LAP (0x010C) Register

The GAIN_LAP register contains the gain applied to the Laplacian filter. Allowed values are from 0 to 2 in increments of 1/4 represented by four unsigned bits with two integer bits and two fractional bits.

The Interrupt Subsystem

STATUS register bits can trigger interrupts so embedded application developers can quickly identify faulty interfaces or incorrectly parameterized cores in a video system. Irrespective of whether the AXI4-Lite control interface is present or not, the Image Edge Enhancement core detects AXI4-Stream framing errors, as well as the beginning and the end of frame processing.

When the core is instantiated with an AXI4-Lite Control interface, the optional interrupt request pin (IRQ) is present. Events associated with bits of the STATUS register can generate a (level triggered) interrupt, if the corresponding bits of the interrupt enable register (IRQ_ENABLE) are set. Once set by the corresponding event, bits of the STATUS register stay set until the user application clears them by writing '1' to the desired bit positions. Using this mechanism the system processor can identify and clear the interrupt source.

Without the AXI4-Lite interface the user can still benefit from the core signaling error and status events. By selecting the **Enable INTC Port** check-box on the GUI, the core generates the optional INTC_IF port. This vector of signals gives parallel access to the individual interrupt sources, as seen in [Table 2-13](#).

Unlike STATUS and ERROR flags, INTC_IF signals are not held, rather stay asserted only while the corresponding event persists.

Table 2-13: INTC_IF Signal Functions

INTC_IF signal	Function
0	Frame processing start
1	Frame processing complete
2	Pixel counter terminal count
3	Line counter terminal count
4	Slave Error
5	EOL Early
6	EOL Late

Table 2-13: INTC_IF Signal Functions

INTC_IF signal	Function
7	SOF Early
8	SOF Late

In a system integration tool, such as EDK, the interrupt controller INTC IP can be used to register the selected `INTC_IF` signals as edge triggered interrupt sources. The INTC IP provides functionality to mask (enable or disable), as well as identify individual interrupt sources from software. Alternatively, for an external processor or MCU the user can custom build a priority interrupt controller to aggregate interrupt requests and identify interrupt sources.

Designing with the Core

Human visual systems detect the boundary of objects best when they are accompanied by sudden changes in brightness. The edge enhancement core exploits this and enhances only the luminance channel. This has the added benefit of eliminating color shifts at the boundary of objects, which are common when enhancing the chrominance components by similar methods. The luminance component is processed through the core in two dimensions using two line buffers. The chrominance components are passed through the core with the proper delay to match luminance processing. This core can accept chrominance components represented as signed or unsigned integers with or without the 128 offset.

The Sobel operators are defined in [Equations 3-1, 3-2, and 3-3](#).

$$\text{Horizontal Sobel} = \begin{bmatrix} -1 & -2 & 1 \\ 0 & 0 & 0 \\ 1 & 2 & 1 \end{bmatrix} \quad \text{Equation 3-1}$$

$$\text{Vertical Sobel} = \begin{bmatrix} -1 & 0 & 1 \\ -2 & 0 & 2 \\ -1 & 0 & 1 \end{bmatrix} \quad \text{Equation 3-2}$$

$$\text{Diagonal Sobels} = \begin{bmatrix} -2 & -1 & 0 \\ -1 & 0 & 1 \\ 0 & 1 & 2 \end{bmatrix} \text{ and } \begin{bmatrix} 0 & 1 & 2 \\ -1 & 0 & 1 \\ -2 & -1 & 0 \end{bmatrix} \quad \text{Equation 3-3}$$

The Laplacian is defined in [Equation 3-4](#).

$$\text{Laplacian} = \begin{bmatrix} 0 & -1 & 0 \\ -1 & 4 & -1 \\ 0 & -1 & 0 \end{bmatrix} \quad \text{Equation 3-4}$$

Defining Gains

The amount and direction of the edge enhancement can be controlled through programmable gains g_H (horizontal), g_V (vertical), g_D (diagonal), and g_{Lap} (Laplacian). Here, a vertical edge is defined as a feature running from top to bottom of an image. Similarly, a horizontal edge runs from left to right across the image. The diagonal direction covers both upper left to lower right and upper right to lower left diagonals.

Gains can be set to values in the range of 0.0 to 2.0. If a particular direction is not desired, that gain can be set to zero to eliminate emphasis in that direction. For example, if vertical edges do not need to be enhanced, the gain g_V should be set to zero.

Additionally, there is an image content dependent gain, K , used to modify the Sobel and Laplacian output. In areas of the image that are smooth and of low contrast, the gain is low to avoid emphasizing noise. This gain is automatically and dynamically calculated by the core on a pixel basis, and it is designed to produce a good compromise between enhancement of features and undesired noise.

If the total gain used $[(g_H+g_V+g_D+g_{Lap}) * K]$ exceeds 1.0, clipping and clamping circuitry limits the enhancement of the edge content. Setting the gains with values greater than 1.0 allows over-enhancing the image to produce special effects like embossing.

Over-emphasis of edges may bring out noise at the edge transitions, and therefore this core may be used in conjunction with noise reduction cores such as the Image Noise Reduction LogiCORE IP to improve the results.

General Design Guidelines

The Image Edge Enhancement core processes samples provided via an AXI4-Stream Video Protocol slave interface, outputs pixels via an AXI4-Stream Video Protocol master interface, and can be controlled via an optional AXI4-Lite interface. The Image Edge Enhancement block cannot change the input/output image sizes, the input and output pixel clock rates, or the frame rate.



RECOMMENDED: *This core should be used in conjunction with the Video In to AXI4-Stream and Video Timing Controller cores.*

The Video Timing Controller core measures the timing parameters, such as number of active scan lines, number of active pixels per scan line of the image sensor. The Video In to AXI4-Stream IP core converts the incoming video data stream to AXI4-Stream Video Protocol.

Typically, the Image Edge Enhancement core is part of a larger system such as the an Image Sensor Pipeline (ISP) System, as shown in [Figure 3-1](#).

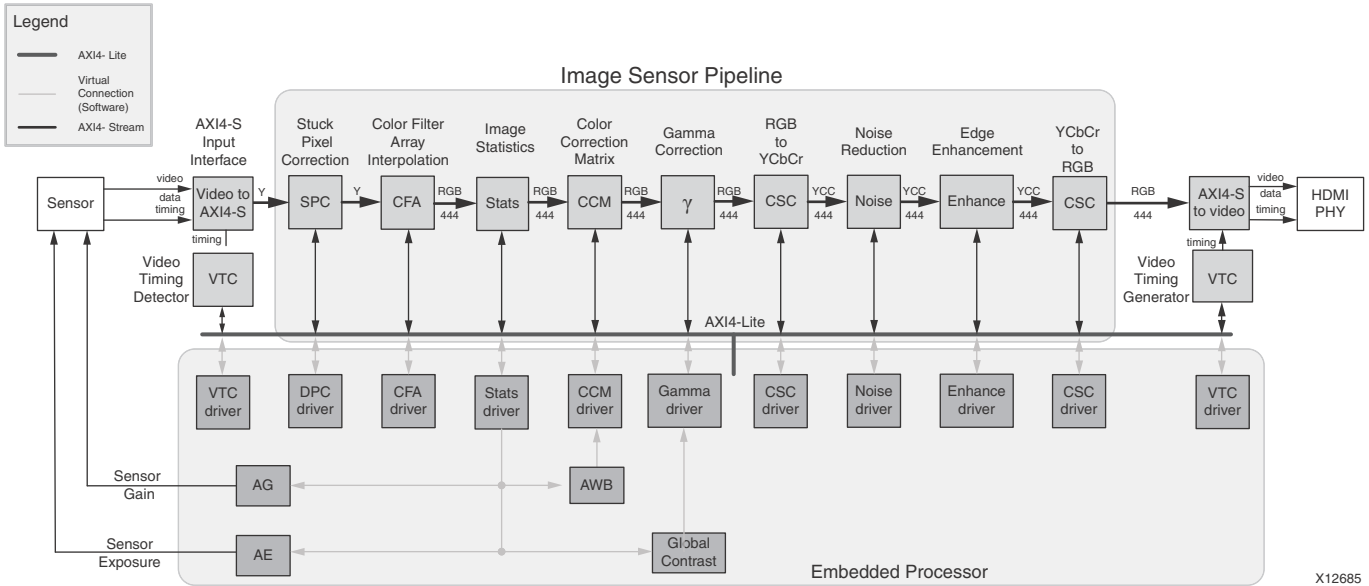

Figure 3-1: Image Sensor Pipeline System with Image Edge Enhancement Core

Clock, Enable, and Reset Considerations

ACLK

The master and slave AXI4-Stream video interfaces use the `ACLK` clock signal as their shared clock reference, as shown in Figure 3-2.

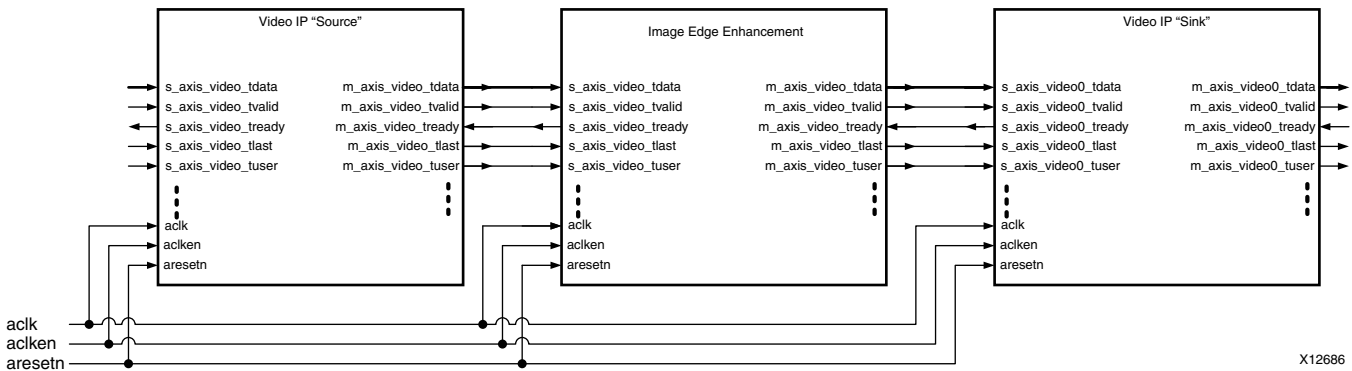

Figure 3-2: Example of ACLK Routing in an ISP Processing Pipeline

S_AXI_ACLK

The AXI4-Lite interface uses the `S_AXI_ACLK` pin as its clock source. The `ACLK` pin is not shared between the AXI4-Lite and AXI4-Stream interfaces. The Image Edge Enhancement core contains clock-domain crossing logic between the `ACLK` (AXI4-Stream and Video Processing) and `S_AXI_ACLK` (AXI4-Lite) clock domains. The core automatically ensures

that the AXI4-Lite transactions will complete even if the video processing is stalled with `ARESETn`, `ACLKEN` or with the video clock not running.

ACLKEN

The Image Edge Enhancement core has two enable options: the `ACLKEN` pin (hardware clock enable), and the software reset option provided via the AXI4-Lite control interface (when present).

`ACLKEN` is by no means synchronized internally to AXI4-Stream frame processing therefore de-asserting `ACLKEN` for extended periods of time may lead to image tearing.

The `ACLKEN` pin facilitates:

- Multi-cycle path designs (high speed clock division without clock gating),
- Standby operation of subsystems to save on power
- Hardware controlled bring-up of system components



IMPORTANT: To prevent transaction errors when `ACLKEN` (clock enable) pins are used (toggled) in conjunction with a common clock source driving the master and slave sides of an AXI4-Stream interface, the `ACLKEN` pins associated with the master and slave component interfaces must also be driven by the same signal (Figure 2-2).



IMPORTANT: When two cores connected via AXI4-Stream interfaces, where only the master or the slave interface has an `ACLKEN` port that is not permanently tied high, the two interfaces should be connected via the AXI4-Stream Interconnect or AXI-FIFO cores to avoid data corruption (Figure 2-3).

S_AXI_ACLKEN

The `S_AXI_ACLKEN` is the clock enable signal for the AXI4-Lite interface only. Driving this signal low will only affect the AXI4-Lite interface and will not halt the video processing in the `ACLK` clock domain.

ARESETn

The Image Edge Enhancement core has two reset source: the `ARESETn` pin (hardware reset), and the software reset option provided via the AXI4-Lite control interface (when present).



CAUTION! `ARESETn` is not synchronized internally to AXI4-Stream frame processing. Therefore, de-asserting `ARESETn` while a frame is being process leads to image tearing.

The external reset pulse needs to be held for 32 `ACLK` cycles to reset the core. The `ARESETn` signal will only reset the AXI4-Stream interfaces. The AXI4-Lite interface is unaffected by the

ARESETn signal to allow the video processing core to be reset without halting the AXI4-Lite interface.



IMPORTANT: *When resetting a system with multiple-clocks and corresponding reset signals, the reset generator must ensure that all reset signals are asserted/de-asserted long enough for all interfaces and clock-domains in all IP cores to correctly reinitialize.*

S_AXI_ARESETn

The S_AXI_ARESETn signal is synchronous to the S_AXI_ACLK clock domain, but is internally synchronized to the ACLK clock domain. The S_AXI_ARESETn signal will reset the entire core including the AXI4-Lite and AXI4-Stream interfaces.

System Considerations

The Image Edge Enhancement core must be configured for the actual image frame-size to operate properly. To gather the frame size information from the incoming video stream, it can be connected to the Video In to AXI4-Stream input and the Video Timing Controller. The timing detector logic in the Video Timing Controller will gather the image sensor timing signals. The AXI4-Lite control interface on the Video Timing Controller allows the system processor to read out the measured frame dimensions, and program all downstream cores, such as the Image Edge Enhancement, with the appropriate image dimensions.

If the target system uses only one, stationary image size, you may choose to consolidate the active-size and enhancement filter gains values, and create a constant configuration by removing the AXI4-Lite interface. This option allows reducing the core Slice footprint.

Clock Domain Interaction

The ARESETn and ACLKEN input signals will not reset or halt the AXI4-Lite interface. This allows the video processing to be reset or halted separately from the AXI4-Lite interface without disrupting AXI4-Lite transactions.

The AXI4-Lite interface will respond with an error if the core registers cannot be read or written within 128 S_AXI_ACLK clock cycles. The core registers cannot be read or written if the ARESETn signal is held low, if the ACLKEN signal is held low or if the ACLK signal is not connected or not running. If core register read does not complete, the AXI4-Lite read transaction will respond with **10** on the S_AXI_RRESP bus. Similarly, if a core register write does not complete, the AXI4-Lite write transaction will respond with **10** on the S_AXI_BRESP bus. The S_AXI_ARESETn input signal resets the entire core.

Programming Sequence

If processing parameters such as the image size needs to be changed on the fly, or the system needs to be reinitialized, it is recommended that pipelined Video IP cores are disabled/reset from system output towards the system input, and programmed/enabled from system input to system output. *STATUS* register bits allow system processors to identify the processing states of individual constituent cores, and successively disable a pipeline as one core after another is finished processing the last frame of data.

Error Propagation and Recovery

Parameterization and/or configuration registers define the dimensions of video frames video IP should process. Starting from a known state and based on the error propagation and recovery settings, the Image Edge Enhancement IP core can predict the expected beginning of the next frame. Similarly, the IP can predict when the last pixel of each scan line is expected. SOF detected before it was expected (early), or SOF not present when it is expected (late), EOL detected before expected (early), or EOL not present when expected (late), signals error conditions indicative of either upstream communication errors or incorrect core configuration.

When SOF is detected early, the output SOF signal is generated early, terminating the previous frame immediately. When SOF is detected late, the output SOF signal is generated according to the programmed values. Extra lines / pixels from the previous frame are dropped until the input SOF is captured.

Similarly, when EOL is detected early, the output EOL signal is generated early, terminating the previous line immediately. When EOL is detected late, the output EOL signal is generated according to the programmed values. Extra pixels from the previous line are dropped until the input EOL is captured.

C Model Reference

The Image Edge Enhancement core has a bit accurate C model designed for system modeling.

Features

- Bit-accurate with the Image Edge Enhancement v5.01.a core
 - Statically linked library (.lib for Windows)
 - Dynamically linked library (.so for Linux)
 - Available for 32-bit and 64-bit Windows platforms and 32-bit and 64-bit Linux platforms
 - Supports all features of the Image Edge Enhancement core that affect numerical results
 - Designed for rapid integration into a larger system model
 - Example C code showing how to use the function is provided
 - Example application C code wrapper file supports 8-bit YUV and BIN
-

Overview

The Image Edge Enhancement core has a bit-accurate C model for 32-bit and 64-bit Windows platforms and 32-bit and 64-bit Linux platforms. The model's interface consists of a set of C functions residing in a statically linked library (shared library).

See [Using the C Model](#) for full details of the interface. A C code example of how to call the model is provided in [C Model Example Code](#).

The model is bit accurate, as it produces exactly the same output data as the core on a frame-by-frame basis. However, the model is not cycle accurate, and it does not model the core's latency or its interface signals.

The latest version of the model is available for download on the Image Edge Enhancement product page at:

<http://www.xilinx.com/products/intellectual-property/EF-DI-IMG-ENHANCE.htm>.

Unpacking and Model Contents

Unzip the `v_enhance_v5_01_a_bitacc_model.zip` file, containing the bit accurate models for the Image Edge Enhancement IP Core. This creates the directory structure and files in [Table 4-1](#).

Table 4-1: Bit Accurate C Model Directory Structure and Files

File Name	Contents
README.txt	Release notes
doc/pg003_v_enhance.pdf	LogiCORE IP Image Edge Enhancement Product Guide
v_enhance_v5_01_a_bitacc_cmodel.h	Model header file
rgb_utils.h	Header file declaring the RGB image/video container type and support functions
yuv_utils.h	Header file declaring the YUV (.yuv) image file I/O functions
bmp_utils.h	Header file declaring the bitmap (.bmp) image file I/O functions
video_utils.h	Header file declaring the generalized image/video container type, I/O and support functions
run_bitacc_cmodel.c	Example code calling the C model
parsers.c	Code for reading configuration file
/examples	Example input files used by C model
enhance.cfg	Sample configuration file containing the core parameter settings
input_image.yuv	Sample test image
input_image.hdr	Sample test image header file
/lin64	Precompiled bit accurate ANSI C reference model for simulation on 64-bit Linux platforms
libIp_v_enhance_v5_01_a_bitacc_cmodel.so	Model shared object library
libstlport.so.5.1	STL library, referenced by <code>libIp_v_enhance_v5_01_a_bitacc_cmodel.so</code>
/lin32	Precompiled bit accurate ANSI C reference model for simulation on 32-bit Linux platforms
libIp_v_enhance_v5_01_a_bitacc_cmodel.so	Model shared object library

Table 4-1: Bit Accurate C Model Directory Structure and Files (Cont'd)

libstlport.so.5.1	STL library, referenced by libIp_v_enhance_v5_01_a_bitacc_cmodel.so
/nt32	Precompiled bit accurate ANSI C reference model for simulation on 32-bit Windows platforms.
libIp_v_enhance_v5_01_a_bitacc_cmodel.dll lib_Ip_v_enhance_v5_01_a_bitacc_cmodel.lib stlport.5.1.dll	Precompiled library file for win32 compilation
/nt64	Precompiled bit accurate ANSI C reference model for simulation on 64-bit Windows platforms.
libIp_v_enhance_v5_01_a_bitacc_cmodel.dll lib_Ip_v_enhance_v5_01_a_bitacc_cmodel.lib stlport.5.1.dll	Precompiled library file for win64 compilation

Installation

For Linux, make sure these files are in a directory that is in your \$LD_LIBRARY_PATH environment variable:

- libIp_v_enhance_v5_01_a_bitacc_cmodel.so
- libstlport.so.5.1

Software Requirements

The Image Edge Enhancement v5.01.a C models were compiled and tested with the software listed in [Table 4-2](#).

Table 4-2: Compilation Tools for the Bit Accurate C Models

Platform	C Compiler
32- and 64-bit Linux	GCC 4.1.1
32- and 64-bit Windows	Microsoft Visual Studio 2008

Using the C Model

The bit accurate C model is accessed through a set of functions and data structures that are declared in the `v_enhance_v5_01_a_bitacc_cmodel.h` file.

Before using the model, the structures holding the inputs, generics and output of the Image Edge Enhancement instance must be defined:

```

struct xilinx_ip_v_enhance_v5_01_a_generics enhance_generics;
struct xilinx_ip_v_enhance_v5_01_a_inputs  enhance_inputs;
struct xilinx_ip_v_enhance_v5_01_a_outputs enhance_outputs;
    
```

The declaration of these structures is in the `v_enhance_v5_01_a_bitacc_cmodel.h` file.

Table 4-3 lists the generic parameters taken by the Image Edge Enhancement v5.01.a IP core bit accurate model, as well as the default values. For an actual instance of the core, these parameters can only be set in generation time through the CORE Generator™ GUI.

Table 4-3: C Model Generic Parameters and Default Values

Generic Variable	Type	Default Value	Range	Description
DATA_WIDTH	int	8	8,10,12	Data width

Calling `xilinx_ip_v_enhance_v5_01_a_get_default_generics(&enhance_generics)` initializes the generics structure with the Image Edge Enhancement GUI defaults, listed in Table 4-3.

Direction gain can also be set dynamically through the AXI4-Lite interface. Consequently, these values are passed as inputs to the core, along with the actual test image, or video sequence (Table 4-4).

Table 4-4: Core Generic Parameters and Default Values

Input Variable	Type	Default Value	Range	Description
video_in	video_struct	null	N/A	Container to hold input image or video data. ¹
gain_h	int	1	Allowed values are 0 to 2 in increments of 1/4	Horizontal gain
gain_v	int	1	Allowed values are 0 to 2 in increments of 1/4	Vertical gain
gain_d	int	1	Allowed values are 0 to 2 in increments of 1/4	Diagonal gain
gain_lap	int	1	Allowed values are 0 to 2 in increments of 1/4	Laplacian filter gain

¹ For the description of the input structure, see [Initializing the Image Edge Enhancement Input Video Structure](#).

The structure `enhance_inputs` defines the values of run time parameters and the actual input image. Calling `xilinx_ip_v_enhance_v5_01_a_get_default_inputs(&enhance_generics, &enhance_inputs)` initializes the input structure with the default values (see [Table 4-4](#)).



IMPORTANT: *The `video_in` variable is not initialized because the initialization depends on the actual test image to be simulated. [Chapter 4, C Model Example Code](#) describes the initialization of the `video_in` structure.*

After the inputs are defined, the model can be simulated by calling this function:

```
int xilinx_ip_v_enhance_v5_01_a_bitacc_simulate(
struct xilinx_ip_v_enhance_v5_01_a_generics* generics,
struct xilinx_ip_v_enhance_v5_01_a_inputs* inputs,
struct xilinx_ip_v_enhance_v5_01_a_outputs* outputs).
```

Results are included in the outputs structure, which contains only one member, type `video_struct`. After the outputs are evaluated and saved, dynamically allocated memory for input and output video structures must be released by calling this function:

```
void xilinx_ip_v_enhance_v5_01_a_destroy(
struct xilinx_ip_v_enhance_v5_01_a_inputs *input,
struct xilinx_ip_v_enhance_v5_01_a_outputs *output).
```

Successful execution of all provided functions, except for the destroy function, return value 0. A non-zero error code indicates that problems occurred during function calls.

Image Edge Enhancement Input and Output Video Structure

Input images or video streams can be provided to the Image Edge Enhancement v5.01.a reference model using the `video_struct` structure, defined in `video_utils.h`:

```
struct video_struct{
int frames, rows, cols, bits_per_component, mode;
uint16*** data[5]; };
```

Table 4-5: Member Variables of the Video Structure

Member Variable	Designation
frames	Number of video/image frames in the data structure.
rows	Number of rows per frame. Pertaining to the image plane with the most rows and columns, such as the luminance channel for YUV data. Frame dimensions are assumed constant through all frames of the video stream. However different planes, such as y, u and v can have different dimensions.

Table 4-5: Member Variables of the Video Structure (Cont'd)

cols	Number of columns per frame. Pertaining to the image plane with the most rows and columns, such as the luminance channel for YUV data. Frame dimensions are assumed constant through all frames of the video stream. However different planes, such as y, u and v can have different dimensions.
bits_per_component	Number of bits per color channel/component. All image planes are assumed to have the same color/component representation. Maximum number of bits per component is 16.
mode	Contains information about the designation of data planes. Named constants to be assigned to mode are listed in Table 4-6 .
data	Set of five pointers to three dimensional arrays containing data for image planes. Data is in 16-bit unsigned integer format accessed as data[plane][frame][row][col].

Table 4-6: Named Video Modes with Corresponding Planes and Representations

Mode	Planes	Video Representation
FORMAT_MONO	1	Monochrome – Luminance only
FORMAT_RGB	3	RGB image/video data
FORMAT_C444	3	444 YUV, or YCrCb image/video data
FORMAT_C422	3	422 format YUV video, (u, v chrominance channels horizontally sub-sampled)
FORMAT_C420	3	420 format YUV video, (u, v sub-sampled both horizontally and vertically)
FORMAT_MONO_M	3	Monochrome (Luminance) video with Motion
FORMAT_RGBA	4	RGB image/video data with alpha (transparency) channel
FORMAT_C420_M	5	420 YUV video with Motion
FORMAT_C422_M	5	422 YUV video with Motion
FORMAT_C444_M	5	444 YUV video with Motion
FORMAT_RGBM	5	RGB video with Motion

The Image Edge Enhancement core supports the mode FORMAT_C444.

Initializing the Image Edge Enhancement Input Video Structure

The easiest way to assign stimuli values to the input video structure is to initialize it with an image or video. The `bmp_util.h` and `video_util.h` header files packaged with the bit accurate C models contain functions to facilitate file I/O.

YUV Image Files

The header `yuv_utils.h` file declares functions that help access files in standard YUV format. It operates on images with three planes (Y, U and V). The following functions operate on arguments of type `yuv8_video_struct`, which is defined in `yuv_utils.h`.

```
int write_yuv8(FILE *outfile, struct yuv8_video_struct *yuv8_video);
int read_yuv8(FILE *infile, struct yuv8_video_struct *yuv8_video);
```

Exchanging data between `yuv8_video_struct` and general `video_struct` type frames/videos is facilitated by these functions:

```
int copy_yuv8_to_video(struct yuv8_video_struct* yuv8_in,
                      struct video_struct* video_out );
int copy_video_to_yuv8(struct video_struct* video_in,
                      struct yuv8_video_struct* yuv8_out );
```

Note: All image/video manipulation utility functions expect both input and output structures initialized; for example, pointing to a structure that has been allocated in memory, either as static or dynamic variables. Moreover, the input structure must have the dynamically allocated container (data or r, g, b) structures already allocated and initialized with the input frame(s). If the output container structure is pre-allocated at the time of the function call, the utility functions verify and issue an error if the output container size does not match the size of the expected output. If the output container structure is not pre-allocated, the utility functions create the appropriate container to hold results.

Binary Image/Video Files

The `video_utils.h` header file declares functions that help load and save generalized video files in raw, uncompressed format.

```
int read_video( FILE* infile, struct video_struct* in_video);
int write_video(FILE* outfile, struct video_struct* out_video);
```

These functions serialize the `video_struct` structure. The corresponding file contains a small, plain text header defining, "Mode", "Frames", "Rows", "Columns", and "Bits per Pixel". The plain text header is followed by binary data, 16-bits per component in scan line continuous format. Subsequent frames contain as many component planes as defined by the video mode value selected. Also, the size (rows, columns) of component planes can differ within each frame as defined by the actual video mode selected.

Working with Video_struct Containers

The `video_utils.h` header file defines functions to simplify access to video data in `video_struct`.

```
int video_planes_per_mode(int mode);
int video_rows_per_plane(struct video_struct* video, int plane);
int video_cols_per_plane(struct video_struct* video, int plane);
```

The `video_planes_per_mode` function returns the number of component planes defined by the mode variable, as described in [Table 4-6](#). The `video_rows_per_plane` and `video_cols_per_plane` functions return the number of rows and columns in a given plane of the selected video structure. The following example demonstrates using these functions in conjunction to process all pixels within a video stream stored in the `in_video` variable:

```
for (int frame = 0; frame < in_video->frames; frame++) {
    for (int plane = 0; plane < video_planes_per_mode(in_video->mode); plane++) {
        for (int row = 0; row < rows_per_plane(in_video,plane); row++) {
            for (int col = 0; col < cols_per_plane(in_video,plane); col++) {
                // User defined pixel operations on
                // in_video->data[plane][frame][row][col]
            }
        }
    }
}
```

C Model Example Code

An example C file, `run_bitacc_cmodel.c`, is provided to demonstrate the steps required to run the model. After following the compilation instructions, run the example executable. The executable takes the path/name of the input file and the path/name of the output file as parameters. If invoked with insufficient parameters, this help message is issued:

```
Usage: run_bitacc_cmodel file_dir config_file
file_dir : path to the location of the input/output files
config_file: path/name of the configuration file
```

The structure of `.bin` files are described in [Binary Image/Video Files](#).

To ease modifying and debugging the provided top-level demonstrator using the built-in debugging environment of Visual Studio, the top-level command line parameters can be specified through the Project Property Pages using these steps:

1. In the Solution Explorer pane, right-click the project name and select **Properties** in the context menu.
2. Select **Debugging** on the left pane of the Property Pages dialog box.
3. Enter the paths and file names of the input and output images in the **Command Arguments** field.

Compiling Image Edge Enhancement C Model with Example Wrapper

Linux (32-bit and 64-bit)

To compile the example code, perform these steps:

1. Set your `$LD_LIBRARY_PATH` environment variable to include the root directory where you unzipped the model zip file using a command such as:

```
setenv LD_LIBRARY_PATH <unzipped_c_model_dir>:${LD_LIBRARY_PATH}
```

2. Copy these files from the `/lin64` directory to the root directory:

```
libstlport.so.5.1
```

```
libIp_v_enhance_v5_01_a_bitacc_cmodel.so
```

3. In the root directory, compile using the GNU C Compiler with this command:

```
gcc -m32 -x c++ ../run_bitacc_cmodel.c./gen_stim.c ./parsers.c -o  
run_bitacc_cmodel -L. -lIp_v_enhance_v5_01_a_bitacc_cmodel -Wl,-rpath,.
```

```
gcc -m64 -x c++ ../run_bitacc_cmodel.c./gen_stim.c ./parsers.c -o  
run_bitacc_cmodel -L. -lIp_v_enhance_v5_01_a_bitacc_cmodel -Wl,-rpath,.
```

Windows (32-bit and 64-bit)

The precompiled library `v_enhance_v5_01_a_bitacc_cmodel.lib`, and top-level demonstration code `run_bitacc_cmodel.c` should be compiled with an ANSI C compliant compiler under Windows. An example procedure is provided here using Microsoft Visual Studio.

1. In Visual Studio, create a new, empty Win32 Console Application project.
2. As existing items, add:
 - a. `libIp_v_enhance_v5_01_a_bitacc_cmodel.lib` to the Resource Files folder of the project
 - b. `run_bitacc_cmodel.c`, `parsers.c`, and `gen_stim.c` to the Source Files folder of the project
 - c. `v_enhance_v5_01_a_bitacc_cmodel.h` to the Header Files folder of the project
3. After the project is created and populated, it must be compiled and linked (built) to create a win32 executable. To perform the build step, select "Build Solution" from the Build menu. An executable matching the project name has been created either in the Debug or Release subdirectories under the project location based on whether "Debug" or "Release" has been selected in the "Configuration Manager" under the Build menu.

SECTION II: VIVADO DESIGN SUITE

Customizing and Generating the Core

Constraining the Core

Detailed Example Design

Customizing and Generating the Core

This chapter includes information about using Xilinx tools to customize and generate the core in the Vivado™ Design Suite environment.

Graphical User Interface

The Image Edge Enhancement core is easily configured to the user's specific needs through the Vivado design tools Graphical User Interface (GUI). This section provides a quick reference to the parameters that can be configured at generation time. [Figure 5-1](#) shows the main Image Edge Enhancement screen.

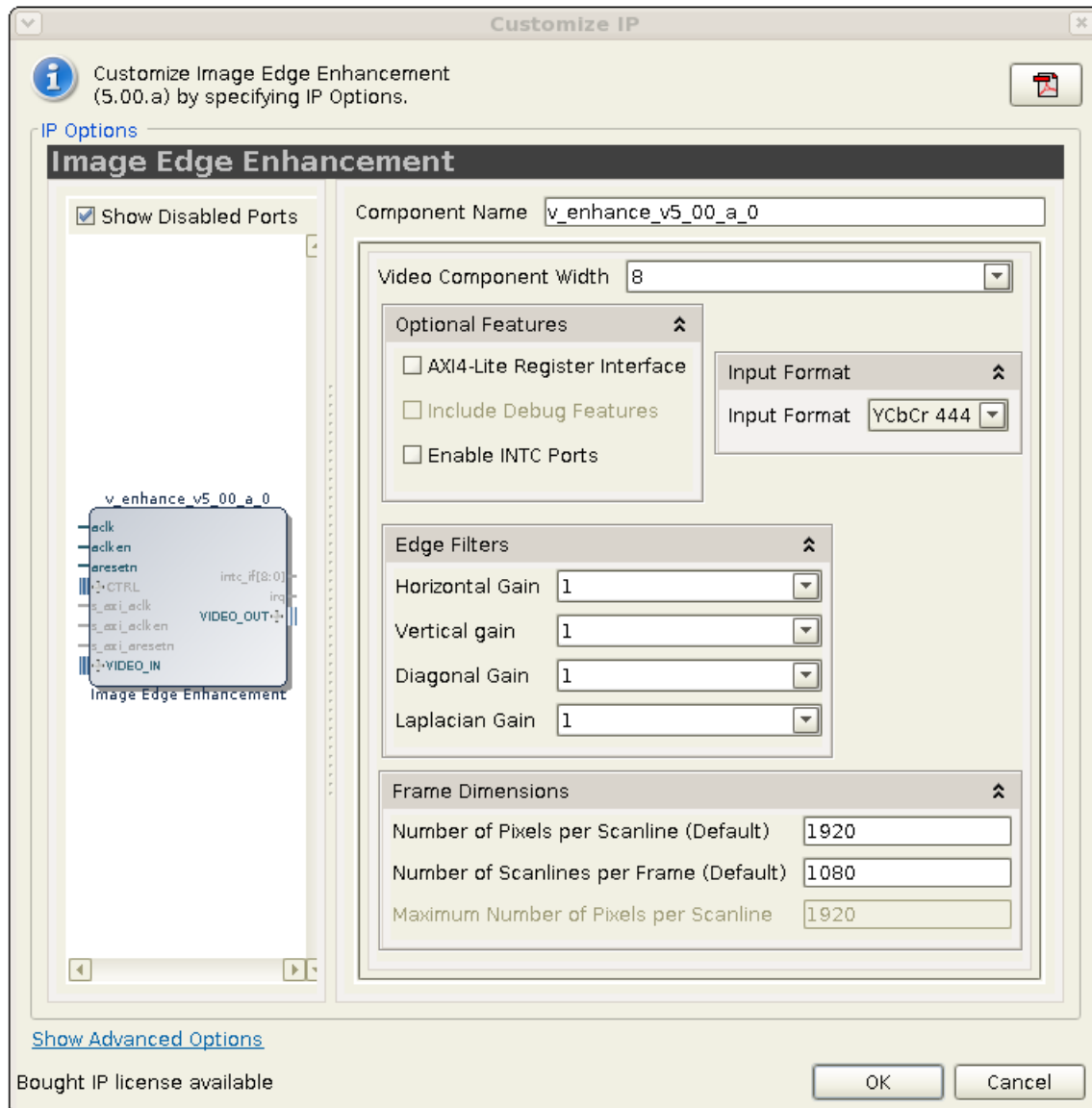

Figure 5-1: Image Edge Enhancement Main Screen

The GUI displays a representation of the IP symbol on the left side, and the parameter assignments on the right side, which are described as follows:

- **Component Name:** The component name is used as the base name of output files generated for the module. Names must begin with a letter and must be composed from characters: a to z, 0 to 9 and "_". The name `v_enhance_v5_01_a` cannot be used as a component name.
- **Video Component Width:** Specifies the bit width of input samples. Permitted values are 8, 10 and 12 bits.

- **Optional Features:**

- **AXI4-Lite Register Interface:** When selected, the core will be generated with an AXI4-Lite interface, which gives access to dynamically program and change processing parameters. For more information, refer to [Control Interface in Chapter 2](#).
- **Include Debugging Features:** When selected, the core will be generated with debugging features, which simplify system design, testing and debugging. For more information, refer to [Debugging Features in Appendix C](#).



IMPORTANT: *Debugging features are only available when the AXI4-Lite Register Interface is selected.*

- **INTC Interface:** When selected, the core will generate the optional `INTC_IF` port, which gives parallel access to signals indicating frame processing status and error conditions. For more information, refer to [The Interrupt Subsystem in Chapter 2](#).
- **Input Frame Dimensions:**
 - **Number of Active Pixels per Scan line:** When the AXI4-Lite control interface is enabled, the generated core will use the value specified in the CORE Generator GUI as the default value for the lower half-word of the `ACTIVE_SIZE` register. When an AXI4-Lite interface is not present, the GUI selection permanently defines the horizontal size of the frames the generated core instance is to process.
 - **Number of Active Lines per Frame:** When the AXI4-Lite control interface is enabled, the generated core will use the value specified in the CORE Generator GUI as the default value for the upper half-word of the `ACTIVE_SIZE` register. When an AXI4-Lite interface is not present, the GUI selection permanently defines the vertical size (number of lines) of the frames the generated core instance is to process.
 - **Maximum Number of Active Pixels Per Scan line:** Specifies the maximum number of pixels per scan line that can be processed by the generated core instance. Permitted values are from 32 to 7680. Specifying this value is necessary to establish the depth of internal line buffers. The actual value selected for Number of Active Pixels per Scan line, or the corresponding lower half-word of the `ACTIVE_SIZE` register must always be less than the value provided by Maximum Number of Active Pixels Per Scan line. Using a tight upper-bound results in optimal block RAM usage. This field is enabled only when the AXI4-Lite interface is selected. Otherwise contents of the field are reflecting the actual contents of the **Number of Active Pixels per Scan line** field as for constant mode the maximum number of pixels equals the active number of pixels.
 - **Horizontal Sobel, Vertical Sobel, Diagonal Sobel, and Laplacian Gains:** Specifies the default gain to be applied for each filter. The possible values are 0.0 to 2.0 in increments of 1/4.

Constraining the Core

Required Constraints

The `ACLK` pin should be constrained at the desired pixel clock rate for your video stream. The `S_AXI_ACLK` pin should be constrained at the frequency of the AXI4-Lite subsystem. In addition to clock frequency, the following constraints should be applied to cover all clock domain crossing data paths.

XDC

```
set_max_delay -to [get_cells -hierarchical -match_style ucf "**U_VIDEO_CTRL*/  
*SYNC2PROCCLK_I*/data_sync_reg[0]*"] -datapath_only 2  
set_max_delay -to [get_cells -hierarchical -match_style ucf "**U_VIDEO_CTRL*/  
*SYNC2VIDCLK_I*/data_sync_reg[0]*"] -datapath_only 2
```

Device, Package, and Speed Grade Selections

There are no device, package, or speed grade requirements for this core. For a complete listing of supported devices, see the release notes for this core. For a complete listing of supported devices, see the [release notes](#) for this core.

Clock Frequencies

The pixel clock (`ACLK`) frequency is the required frequency for this core. See [Chapter 2, Maximum Frequencies](#). The `S_AXI_ACLK` maximum frequency is the same as the `ACLK` maximum.

Clock Management

The core automatically handles clock domain crossing between the `ACLK` (video pixel clock and AXI4-Stream) and the `S_AXI_ACLK` (AXI4-Lite) clock domains. The `S_AXI_ACLK` clock can be slower or faster than the `ACLK` clock signal, but must not be more than 128x faster than `ACLK`.

Clock Placement

There are no specific Clock placement requirements for this core.

Banking

There are no specific Banking rules for this core.

Transceiver Placement

There are no Transceiver Placement requirements for this core.

I/O Standard and Placement

There are no specific I/O standards and placement requirements for this core.

Detailed Example Design

No example design is available at the time for the LogiCORE IP Image Edge Enhancement v5.01a core.

Demonstration Test Bench

A demonstration test bench is provided with the core which enables you to observe core behavior in a typical scenario. This test bench is generated together with the core in Vivado design tools. You are encouraged to make simple modifications to the configurations and observe the changes in the waveform.

Generating the Test Bench

After customizing the IP, right-click on the core instance in **Sources** pane and select **Generate Output Products** ([Figure 7-1](#)).

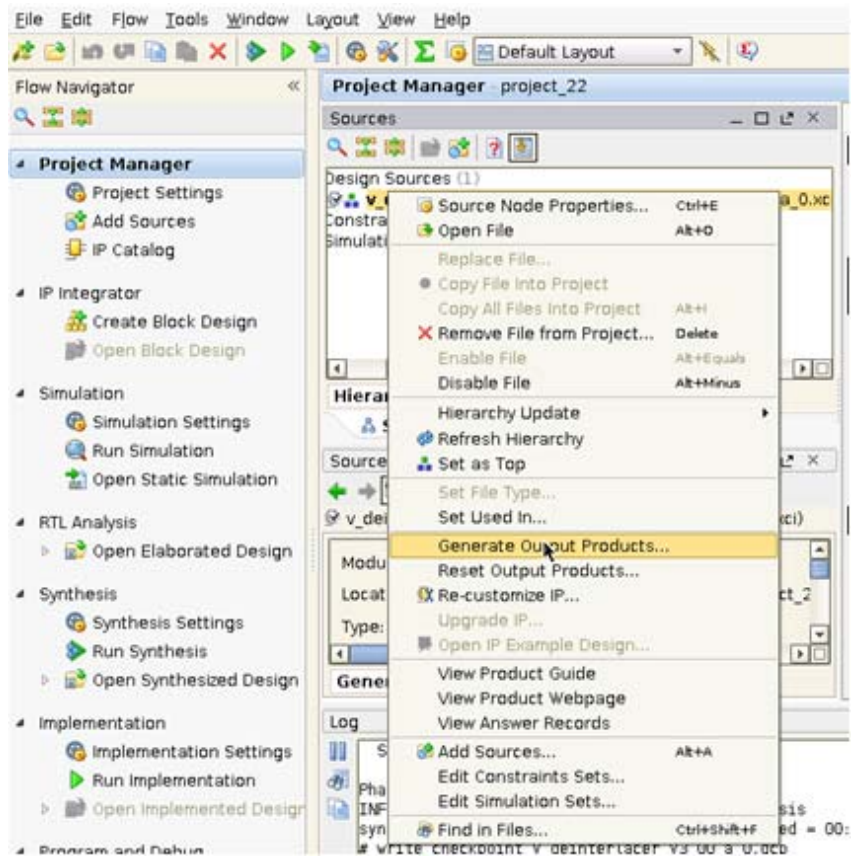

Figure 7-1: Sources Pane

A pop-up window prompts you to select items to generate.

Click on **Test Bench** and make sure **Action: Generate** is selected.

The demonstration test bench package will be generated in the following directory (Figure 7-2):

```
<PROJ_DIR>/<PROJ_NAME>.srcs/sources_1/ip/<IP_INSTANCE_NAME>/<IP_INSTANCE_NAME>/demo_tb/
```

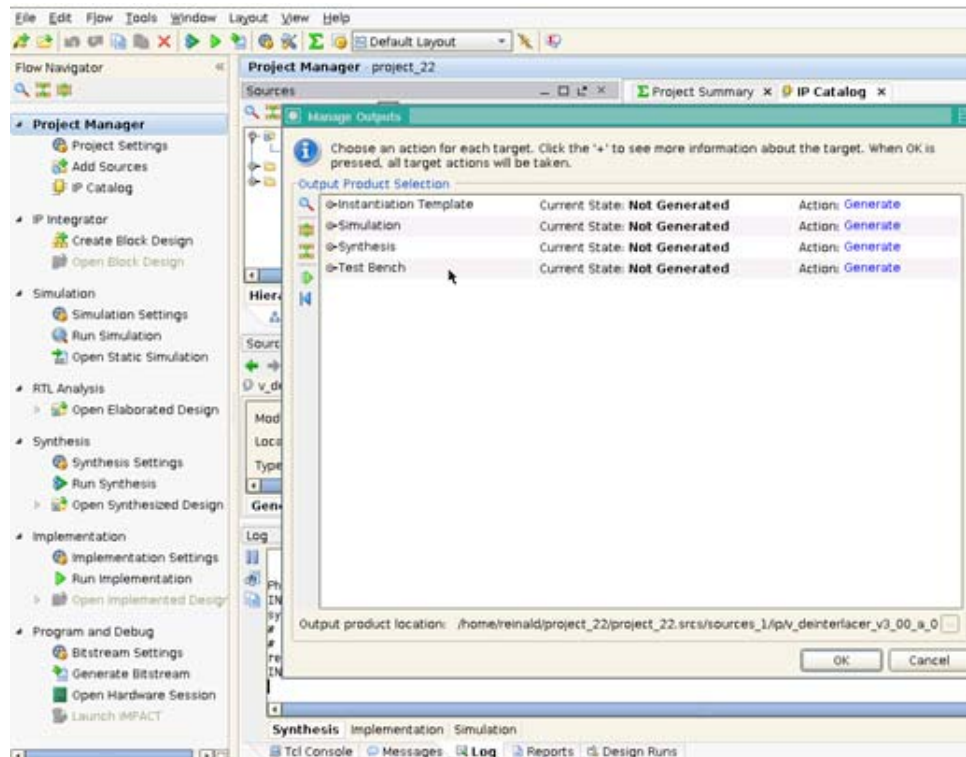



Figure 7-2: Demonstration Test Bench Package

Directory and File Contents

The following files are expected to be generated in the in the demo test bench output directory:

- axi4lite_mst.v
- axi4s_video_mst.v
- axi4s_video_slv.v
- ce_generator.v
- tb_<IP_instance_name>.v

Test Bench Structure

The top-level entity is **tb_<IP_instance_name>**.

It instantiates the following modules:

- DUT
 - The <IP> core instance under test.
- axi4lite_mst

The AXI4-Lite master module, which initiates AXI4-Lite transactions to program core registers.

- `axi4s_video_mst`

The AXI4-Stream master module, which generates ramp data and initiates AXI4-Stream transactions to provide video stimuli for the core and can also be used to open stimuli files generated from the reference C-models and convert them into corresponding AXI4-Stream transactions.

To do this, edit `tb_<IP_instance_name>.v`:

- a. Add define macro for the stimuli file name and directory path
`define STIMULI_FILE_NAME<path><filename>.`
- b. Comment-out/remove the following line:
`MST.is_ramp_gen(`C_ACTIVE_ROWS, `C_ACTIVE_COLS, 2);`
and replace with the following line:
`MST.use_file(`STIMULI_FILE_NAME);`

For information on how to generate stimuli files, refer to [C Model Reference](#).

- `axi4s_video_slv`

The AXI4-Stream slave module, which acts as a passive slave to provide handshake signals for the AXI4-Stream transactions from the core's output, can be used to open the data files generated from the reference C-model and verify the output from the core.

To do this, edit `tb_<IP_instance_name>.v`:

- a. Add define macro for the golden file name and directory path
`define GOLDEN_FILE_NAME "<path><filename>".`
- b. Comment-out the following line:
`SLV.is_passive;`
and replace with the following line:
`SLV.use_file(`GOLDEN_FILE_NAME);`

For information on how to generate golden files, refer to [C Model Reference](#).

- `ce_gen`

Programmable Clock Enable (ACLKEN) generator.

Running the Simulation

There are two ways to run the demonstration test bench, after successfully generating the core output:

Option 1: Launch Simulation from the Vivado GUI

This runs the test bench with the AXI4-Stream Master producing ramp data as stimuli, and AXI4-Stream Slave set to passive mode.

1. Click **Simulation Settings** in the Flow Navigation window, change Simulation top module name to **tb_<IP_instance_name>**.
2. Click **Run Simulation**. XSIM launches and you should be able to see the signals.
3. You can also choose Modelsim for simulation by going to **Project Settings** and selecting Modelsim as the Target Simulator ([Figure 7-3](#)).

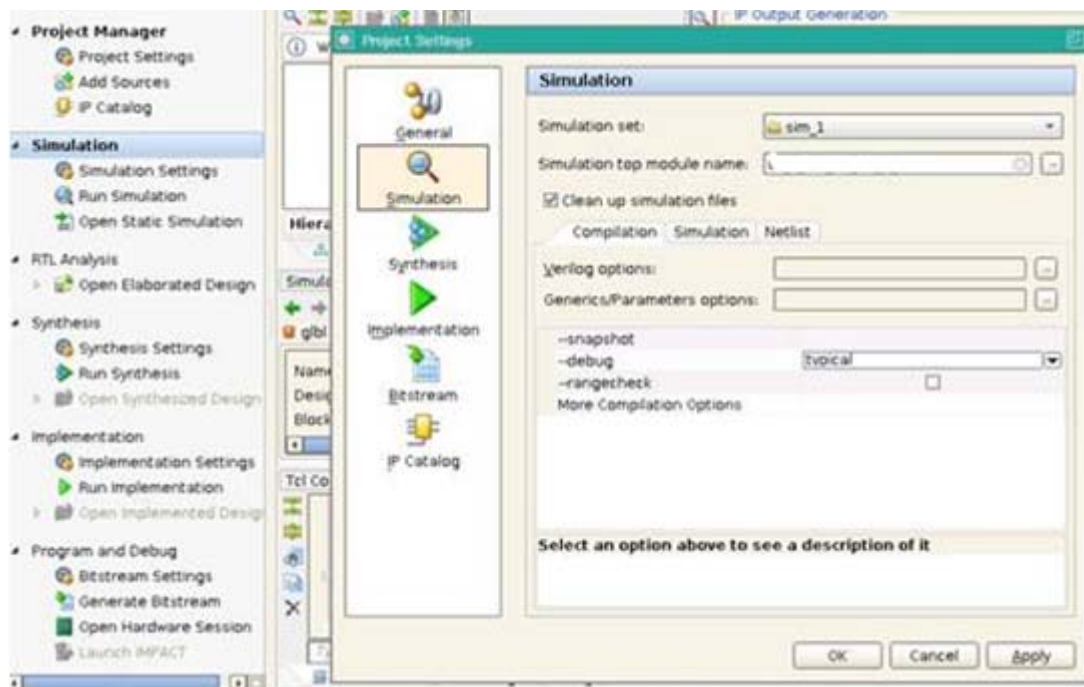

Figure 7-3: Simulation GUI

Option 2: Manually Compile and Run from the Simulation Environment

1. Add the generated test bench files to a new simulation set, along with the customized IP. For information on the location of generated test bench files, refer to [Generating the Test Bench](#).
2. Setup the environment variables for Xilinx libraries
3. Compile the generated IP

4. Compile the test bench files
5. Run the simulation



RECOMMENDED: *Change the default simulation time from **1000 ns** to **all** to be able observe a full frame transaction.*

SECTION III: ISE DESIGN SUITE

Customizing and Generating the Core

Constraining the Core

Detailed Example Design

Customizing and Generating the Core

This chapter includes information about using Xilinx tools to customize and generate the core in the ISE® Design Suite environment.

Graphical User Interface

The Image Edge Enhancement core is easily configured to the user's specific needs through the CORE Generator™ or EDK GUIs. This section provides a quick reference to the parameters that can be configured at generation time. Figure 8-1 shows the main Image Edge Enhancement screen.

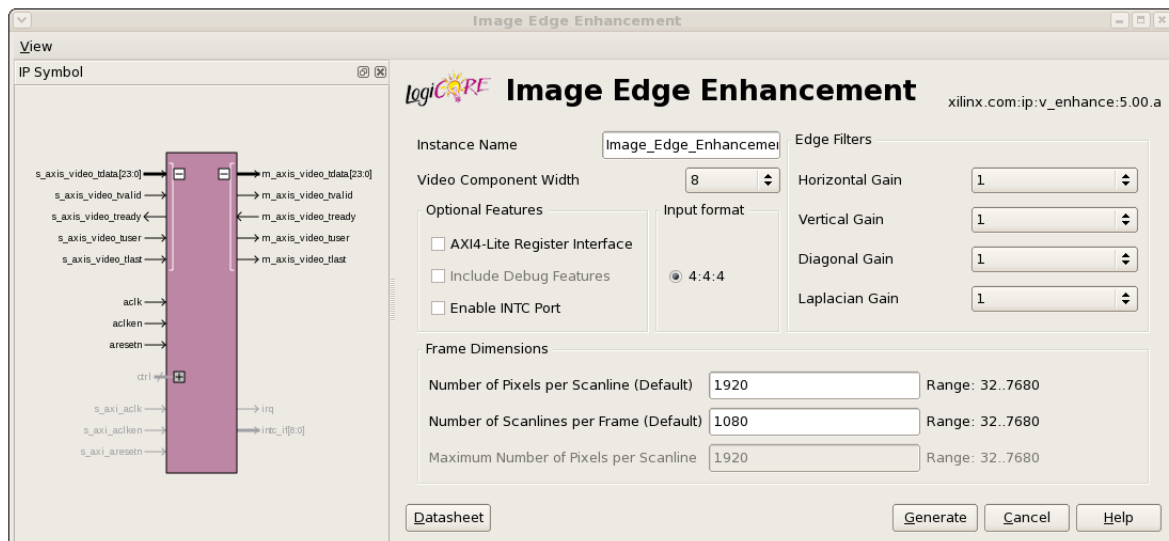

Figure 8-1: Image Edge Enhancement Main Screen

The GUI displays a representation of the IP symbol on the left side, and the parameter assignments on the right side, which are described as follows:

- Component Name:** The component name is used as the base name of output files generated for the module. Names must begin with a letter and must be composed from characters: a to z, 0 to 9 and "_". The name `v_enhance_v5_01_a` cannot be used as a component name.

- **Video Component Width:** Specifies the bit width of input samples. Permitted values are 8, 10, and 12 bits.
- **Optional Features:**
 - **AXI4-Lite Register Interface:** When selected, the core will be generated with an AXI4-Lite interface, which gives access to dynamically program and change processing parameters. For more information, refer to [Control Interface in Chapter 2](#).
 - **Include Debugging Features:** When selected, the core will be generated with debugging features, which simplify system design, testing and debugging. For more information, refer to [Debugging Features in Appendix C](#).



IMPORTANT: *Debugging features are only available when the AXI4-Lite Register Interface is selected.*

- **INTC Interface:** When selected, the core will generate the optional `INTC_IF` port, which gives parallel access to signals indicating frame processing status and error conditions. For more information, refer to [The Interrupt Subsystem in Chapter 2](#).
- **Input Frame Dimensions:**
 - **Number of Active Pixels per Scan line:** When the AXI4-Lite control interface is enabled, the generated core will use the value specified in the CORE Generator GUI as the default value for the lower half-word of the `ACTIVE_SIZE` register. When an AXI4-Lite interface is not present, the GUI selection permanently defines the horizontal size of the frames the generated core instance is to process.
 - **Number of Active Lines per Frame:** When the AXI4-Lite control interface is enabled, the generated core will use the value specified in the CORE Generator GUI as the default value for the upper half-word of the `ACTIVE_SIZE` register. When an AXI4-Lite interface is not present, the GUI selection permanently defines the vertical size (number of lines) of the frames the generated core instance is to process.
 - **Maximum Number of Active Pixels Per Scan line:** Specifies the maximum number of pixels per scan line that can be processed by the generated core instance. Permitted values are from 32 to 7680. Specifying this value is necessary to establish the depth of internal line buffers. The actual value selected for Number of Active Pixels per Scan line, or the corresponding lower half-word of the `ACTIVE_SIZE` register must always be less than the value provided by Maximum Number of Active Pixels Per Scan line. Using a tight upper-bound results in optimal block RAM usage. This field is enabled only when the AXI4-Lite interface is selected. Otherwise contents of the field are reflecting the actual contents of the **Number of Active Pixels per Scan line** field as for constant mode the maximum number of pixels equals the active number of pixels.
- **Horizontal Sobel, Vertical Sobel, Diagonal Sobel, and Laplacian Gains:** Specifies the default gain to be applied for each filter. The possible values are 0.0 to 2.0 in increments of 1/4.

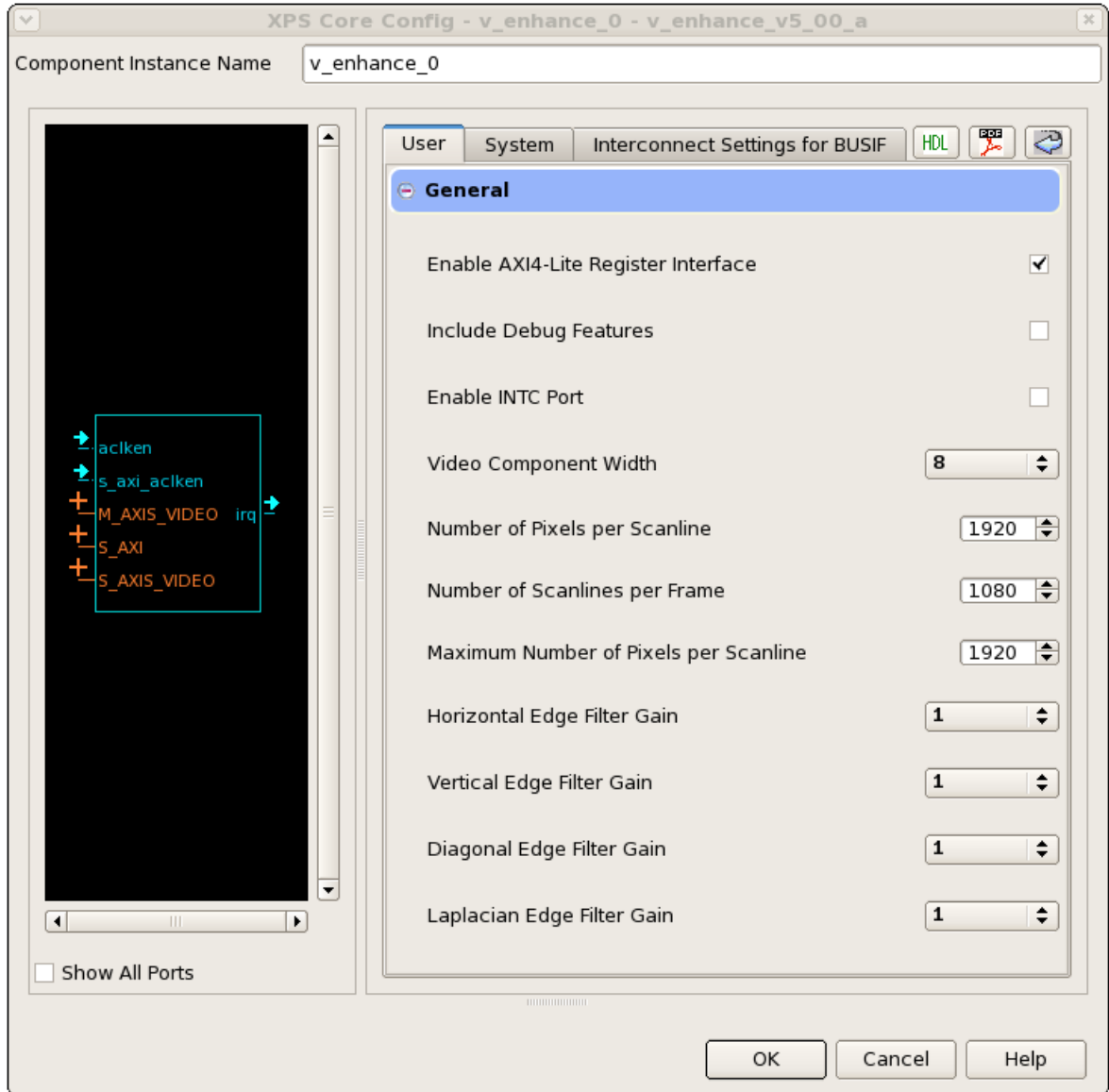

Figure 8-2: Image Edge Enhancement EDK GUI Screen

Definitions of the EDK GUI controls are identical to the corresponding CORE Generator GUI functions.

Parameter Values in the XCO File

The following table defines valid entries for the XCO parameters. Parameters are not case sensitive. Xilinx strongly suggests that XCO parameters are not manually edited in the XCO file; instead, use the CORE Generator tool GUI to configure the core and perform range and parameter value checking.

Table 8-1: XCO Parameters

XCO Parameter	Default	Valid Values
component_name	edge_enhancement	ASCII text using characters: a..z, 0..9 and "_" starting with a letter. Note: v_enhance_v5_01_a is not allowed.
s_axis_video_data_width	8	8, 10, 12
has_axi4_lite	true	true, false
has_intc_if	false	true, false
has_debug	false	true, false
active_cols	1920	32 - 7680
active_rows	1080	32 - 7680
max_cols	1920	32 - 7680
gain_h	1	0 to 2 in 1/4th increments
gain_v	1	0 to 2 in 1/4th increments
gain_d	1	0 to 2 in 1/4th increments
gain_lap	1	0 to 2 in 1/4th increments

Output Generation

CORE Generator will output the core as a netlist that can be inserted into a processor interface wrapper or instantiated directly in an HDL design. The output is placed in the <project director>.

File Details

The CORE Generator output consists of some or all the following files.

Table 8-2: CORE Generator Output

Name	Description
<component_name>.xco	CORE Generator input file containing the parameters used to generate a core.
<component_name>.ngc	Binary Xilinx implementation netlist files containing the information required to implement the module in a Xilinx (R) FPGA.
<component_name>.vho <component_name>.veo	Template files containing code that can be used as a model for instantiating
<component_name>.vhd <component_name>.v	Structural simulation model

Table 8-2: CORE Generator Output (Cont'd)

Name	Description
/doc/pg002_v_enhance.pdf /doc/v_enhance_v5_01_a_vinfo.html	Core documents
<component_name>.asy	Graphical symbol information file. Used by the ISE tools and some third party tools to create a symbol representing the core.
<component_name>_xmdf.tcl	ISE Project Navigator interface file. ISE uses this file to determine how the files output by CORE Generator for the core can be integrated into your ISE project.
<component_name>.gise <component_name>.xise	ISE Project Navigator support files. These are generated files and should not be edited directly.
<component_name>_readme.txt	Readme file for the IP.
<component_name>_flist.txt	Text file listing all of the output files produced when a customized core was generated in the CORE Generator.

Constraining the Core

Required Constraints

The `ACLK` pin should be constrained at the desired pixel clock rate for your video stream.

The `S_AXI_ACLK` pin should be constrained at the frequency of the AXI4-Lite subsystem.

In addition to clock frequency, the following constraints should be applied to cover all clock domain crossing data paths.

UCF

```
INST "**U_VIDEO_CTRL*/**SYNC2PROCCLK_I*/data_sync_reg[0]*" TNM =
"async_clock_conv_FFDEST";
TIMESPEC "TS_async_clock_conv" = FROM FFS TO "async_clock_conv_FFDEST" 2 NS
DATAPATHONLY;
INST "**U_VIDEO_CTRLk*/**SYNC2VIDCLK_I*/data_sync_reg[0]*" TNM =
"vid_async_clock_conv_FFDEST";
TIMESPEC "TS_vid_async_clock_conv" = FROM FFS TO "vid_async_clock_conv_FFDEST" 2 NS
DATAPATHONLY;
```

Device, Package, and Speed Grade Selections

There are no device, package, or speed grade requirements for this core. For a complete listing of supported devices, see the release notes for this core. For a complete listing of supported devices, see the [release notes](#) for this core.

Clock Frequencies

The pixel clock (`ACLK`) frequency is the required frequency for this core. See [Chapter 2, Maximum Frequencies](#). The `S_AXI_ACLK` maximum frequency is the same as the `ACLK` maximum.

Clock Management

The core automatically handles clock domain crossing between the `ACLK` (video pixel clock and AXI4-Stream) and the `S_AXI_ACLK` (AXI4-Lite) clock domains. The `S_AXI_ACLK` clock can be slower or faster than the `ACLK` clock signal, but must not be more than 128x faster than `ACLK`.

Clock Placement

There are no specific Clock placement requirements for this core.

Banking

There are no specific Banking rules for this core.

Transceiver Placement

There are no Transceiver Placement requirements for this core.

I/O Standard and Placement

There are no specific I/O standards and placement requirements for this core.

Detailed Example Design

No example design is available at the time for the LogiCORE IP Image Edge Enhancement v5.01a core.

Demonstration Test Bench

A demonstration test bench is provided which enables core users to observe core behavior in a typical use scenario. The user is encouraged to make simple modifications to the test conditions and observe the changes in the waveform.

Test Bench Structure

The top-level entity, `tb_main.v`, instantiates the following modules:

- DUT
The Image Edge Enhancement v5.01.a core instance under test.
- `axi4lite_mst`
The AXI4-Lite master module, which initiates AXI4-Lite transactions to program core registers.
- `axi4s_video_mst`
The AXI4-Stream master module, which opens the stimuli txt file and initiates AXI4-Stream transactions to provide stimuli data for the core
- `axi4s_video_slv`
The AXI4-Stream slave module, which opens the result txt file and verifies AXI4-Stream transactions from the core
- `ce_gen`
Programmable Clock Enable (`ACLKEN`) generator

Running the Simulation

- Simulation using ModelSim for Linux:
From the console, Type "source run_mti.sh".
 - Simulation using iSim for Linux:
From the console, Type "source run_isim.sh".
 - Simulation using ModelSim for Windows:
Double-click on "run_mti.bat" file.
 - Simulation using iSim:
Double-click on "run_isim.bat" file.
-

Directory and File Contents

The directory structure underneath the top-level folder is:

- **Expected**
Contains the pre-generated expected/golden data used by the test bench to compare actual output data.
- **Stimuli**
Contains the pre-generated input data used by the test bench to stimulate the core (including register programming values).
- **Results**
Actual output data will be written to a file in this folder.
- **Src**
Contains the .vhd simulation files and the .xco CORE Generator parameterization file of the core instance. The .vhd file is a netlist generated using CORE Generator. The .xco file can be used to regenerate a new netlist using CORE Generator.

The available core C-model can be used to generate stimuli and expected results for any user bmp image. For more information, refer to [Chapter 4, C Model Reference](#).

The top-level directory contains packages and Verilog modules used by the test bench, as well as:

- isim_wave.wcfg:
Waveform configuration for ISIM
- mti_wave.do:
Waveform configuration for ModelSim

- run_isim.bat:
Runscript for iSim in Windows
- run_isim.sh:
Runscript for iSim in Linux
- run_mti.bat:
Runscript for ModelSim in Windows
- run_mti.sh:
Runscript for ModelSim in Linux

SECTION IV: APPENDICES

Verification, Compliance, and Interoperability

Migrating

Debugging

Additional Resources

Verification, Compliance, and Interoperability

Simulation

A highly parameterizable test bench was used to test the Image Edge Enhancement core. Testing included the following:

- Register accesses
 - Processing multiple frames of data
 - AXI4-Stream bidirectional data-throttling tests
 - Testing detection, and recovery from various AXI4-Stream framing error scenarios
 - Testing different `ACLKEN` and `ARESETn` assertion scenarios
 - Testing of various frame sizes
 - Varying parameter settings
-

Hardware Testing

The Image Edge Enhancement core has been validated in hardware at Xilinx to represent a variety of parameterizations, including the following:

- A test design was developed for the core that incorporated a MicroBlaze™ processor, AXI4-Lite interconnect and various other peripherals. The software for the test system included pre-generated input and output data along with live video stream. The MicroBlaze processor was responsible for:
 - Initializing the appropriate input and output buffers
 - Initializing the Image Edge Enhancement core
 - Launching the test
 - Comparing the output of the core against the expected results

- Reporting the Pass/Fail status of the test and any errors that were found

Interoperability

The core slave (input) AXI4 Stream interface can work directly with any Xilinx Video core that produces YCbCr 4:4:4. The core master (output) interface can work directly with any Xilinx Video core which consumes YCbCr 4:4:4 data.

The AXI4-Stream interfaces must be compliant to the AXI4-Stream Video Protocol as described in *Video IP: AXI Feature Adoption* section of the [UG761 AXI Reference Guide](#).

Migrating

For information about migration from ISE Design Suite to Vivado Design Suite, see *Vivado Design Suite Migration Methodology Guide* (UG911) [Ref 2].

For a complete list of Vivado User and Methodology Guides, see the [Vivado Design Suite - 2012.3 User Guides web page](#).

From version v3.0 to v5.01.a of the Image Edge Enhancement core the following significant changes took place:

- XSVI interfaces were replaced by AXI4-Stream interfaces
- Since AXI4-Stream does not carry video timing data, the timing detector and timing generator modules were trimmed.
- The pCore, General Purpose Processor and Constant modes became obsolete and were removed
- Native support for EDK have been added - the Image Edge Enhancement core appears in the EDK IP Catalog
- Debugging features have been added
- The AXI4-Lite control interface register map is standardized between Xilinx video cores

Because of the complex nature of these changes, replacing a v3.0 version of the core in a customer design is not trivial. An existing EDK pCore or Constant Image Edge Enhancement instance can be converted from XSVI to AXI4-Stream, using the Video In to AXI4-Stream core or components from XAPP521 (v1.0), *Bridging Xilinx Streaming Video Interface with the AXI4-Stream Protocol* located at:

http://www.xilinx.com/support/documentation/application_notes/xapp521_XSVI_AXI4.pdf.

A v3.0 pCore instance in EDK can be replaced from v5.01.a directly from the EDK IP Catalog. However, the application software needs to be updated for the changed functionality and addresses of the `IRQ_ENABLE`, `STATUS`, `ERROR`, and `GAIN` registers. Consider replacing a legacy Image Edge Enhancement pCore from EDK with a v5.01.a instance without AXI4-Lite interface to save resources.

If the user design explicitly used the timing detector or generator functionality of the Image Edge Enhancement core, consider adding the Video Timing Controller core to migrate the functionality.

An ISE design using the General Purpose Processor interface, all of the above steps might be necessary:

- Timing detection, generation using the Video Timing Controller Core
- Replacing XSVI interfaces with conversion modules described in XAPP521 or try using the Video In to AXI4-Stream core
- Updating the Image Edge Enhancement core instance to v5.01.a with or without AXI4-Lite interface

The INTC interface and debug functionality are new features for v5.01.a. When migrating an existing design, these functions may be disabled.

Debugging

It is recommended to prototype the system with the AXI4-Stream interface enabled, so status and error detection, reset, and dynamic size programming can be used during debugging.

The following steps are recommended to bring-up/debug the core in a video/imaging system:

1. Bring up the AXI4-Lite interface
2. Bring up the AXI4-Stream interfaces
 - (Optional) Balancing throughput

Once the core is working as expected, the user may consider 'hardening' the configuration by replacing the Image Edge Enhancement core with an instance where GUI default values are set to the established `ACTIVE_SIZE` and `GAIN` values, but the AXI4-Lite interface is disabled. This configuration reduces the core slice footprint.

Bringing up the AXI4-Lite Interface

Table C-1 describes how to troubleshoot the AXI4-Lite interface.

Table C-1: Troubleshooting the AXI4-Lite Interface

Symptom	Solution
Readback from the Version Register via the AXI4-Lite interface times out, or a core instance without an AXI4-Lite interface seems non-responsive.	Are the <code>S_AXI_ACLK</code> and <code>ACLK</code> pins connected? In EDK, verify that the <code>S_AXI_ACLK</code> and <code>ACLK</code> pin connections in the <code>system.mhs</code> file. The <code>VERSION_REGISTER</code> readout issue may be indicative of the core not receiving the AXI4-Lite interface.
Readback from the Version Register via the AXI4-Lite interface times out, or a core instance without an AXI4-Lite interface seems non-responsive.	Is the core enabled? Is <code>s_axi_aclken</code> connected to <code>vcc</code> ? In EDK, verify that signal <code>ACLKEN</code> is connected in the <code>system.mhs</code> to either <code>net_vcc</code> or to a designated clock enable signal.

Table C-1: Troubleshooting the AXI4-Lite Interface (Cont'd)

Symptom	Solution
Readback from the Version Register via the AXI4-Lite interface times out, or a core instance without an AXI4-Lite interface seems non-responsive.	Is the core in reset? S_AXI_ARESETn and ARESETn should be connected to vcc for the core not to be in reset. In EDK, verify that the S_AXI_ARESETn and ARESETn signals are connected in the system.mhs to either net_vcc or to a designated reset signal.
Readback value for the VERSION_REGISTER is different from expected default values	The core and/or the driver in a legacy EDK/SDK project has not been updated. Ensure that old core versions, implementation files, and implementation caches have been cleared.

Assuming the AXI4-Lite interface works, the second step is to bring up the AXI4-Stream interfaces.

Bringing up the AXI4-Stream Interfaces

Table C-2 describes how to troubleshoot the AXI4-Stream interface.

Table C-2: Troubleshooting AXI4-Stream Interface

Symptom	Solution
Bit 0 of the ERROR register reads back set.	Bit 0 of the ERROR register, EOL_EARLY, indicates the number of pixels received between the latest and the preceding End-Of-Line (EOL) signal was less than the value programmed into the ACTIVE_SIZE register. If the value was provided by the Video Timing Controller core, read out ACTIVE_SIZE register value from the VTC core again, and make sure that the TIMING_LOCKED flag is set in the VTC core. Otherwise, using Chipscope, measure the number of active AXI4-Stream transactions between EOL pulses.
Bit 1 of the ERROR register reads back set.	Bit 1 of the ERROR register, EOL_LATE, indicates the number of pixels received between the last End-Of-Line (EOL) signal surpassed the value programmed into the ACTIVE_SIZE register. If the value was provided by the Video Timing Controller core, read out ACTIVE_SIZE register value from the VTC core again, and make sure that the TIMING_LOCKED flag is set in the VTC core. Otherwise, using Chipscope, measure the number of active AXI4-Stream transactions between EOL pulses.
Bit 2 or Bit 3 of the ERROR register reads back set.	Bit 2 of the ERROR register, SOF_EARLY, and bit 3 of the ERROR register SOF_LATE indicate the number of pixels received between the latest and the preceding Start-Of-Frame (SOF) differ from the value programmed into the ACTIVE_SIZE register. If the value was provided by the Video Timing Controller core, read out ACTIVE_SIZE register value from the VTC core again, and make sure that the TIMING_LOCKED flag is set in the VTC core. Otherwise, using Chipscope, measure the number EOL pulses between subsequent SOF pulses.
s_axis_video_tready stuck low, the upstream core cannot send data.	During initialization, line-, and frame-flushing, the Image Edge Enhancement core keeps its s_axis_video_tready input low. Afterwards, the core should assert s_axis_video_tready automatically. Is m_axis_video_tready low? If so, the Image Edge Enhancement core cannot send data downstream, and the internal FIFOs are full.

Table C-2: Troubleshooting AXI4-Stream Interface

Symptom	Solution
m_axis_video_tvalid stuck low, the downstream core is not receiving data	<ol style="list-style-type: none"> 1. No data is generated during the first two lines of processing. 2. If the programmed active number of pixels per line is radically smaller than the actual line length, the core drops most of the pixels waiting for the (s_axis_video_tlast) End-of-line signal. Check the ERROR register.
Generated SOF signal (m_axis_video_tuser0) signal misplaced.	Check the ERROR register.
Generated EOL signal (m_axis_video_tlast) signal misplaced.	Check the ERROR register.
Data samples lost between Upstream core and the Image Edge Enhancement core. Inconsistent EOL and/or SOF periods received.	<ol style="list-style-type: none"> 1. Are the Master and Slave AXI4-Stream interfaces in the same clock domain? 2. Is proper clock-domain crossing logic instantiated between the upstream core and the Image Edge Enhancement core (Asynchronous FIFO)? 3. Did the design meet timing? 4. Is the frequency of the clock source driving the Image Edge Enhancement ACLK pin lower than the reported Fmax reached?
Data samples lost between Downstream core and the Image Edge Enhancement core. Inconsistent EOL and/or SOF periods received.	<ol style="list-style-type: none"> 1. Are the Master and Slave AXI4-Stream interfaces in the same clock domain? 2. Is proper clock-domain crossing logic instantiated between the upstream core and the Image Edge Enhancement core (Asynchronous FIFO)? 3. Did the design meet timing? 4. Is the frequency of the clock source driving the Image Edge Enhancement ACLK pin lower than the reported Fmax reached?

If the AXI4-Stream communication is healthy, but the data seems corrupted, the next step is to find the correct configuration for the Image Edge Enhancement core.

Debugging Features

The Image Edge Enhancement core is equipped with optional debugging features which aim to accelerate system bring-up, optimize memory and data-path architecture and reduce time to market. The optional debug features can be turned on/off via the **Include Debug Features** checkbox on the GUI when an AXI4-Lite interface is present. Turning off debug features reduces the core Slice footprint.

Core Bypass Option

The bypass option facilitates establishing a straight through connection between input (AXI4-Stream slave) and output (AXI4-Stream master) interfaces bypassing any processing functionality.

Flag `BYPASS` (bit 4 of the `CONTROL` register) can turn bypass on (1) or off, when the core instance Debugging Features were enabled at generation. Within the IP this switch controls multiplexers in the AXI4-Stream path.

In bypass mode the Image Edge Enhancement core processing function is bypassed, and the core repeats AXI4-Stream input samples on its output.

Starting a system with all processing cores set to bypass, then by turning bypass off from the system input towards the system output allows verification of subsequent cores with known good stimuli.

Built in Test-Pattern Generator

The optional built-in test-pattern generator facilitates to temporarily feed the output AXI4-Stream master interface with a predefined pattern.

Flag `TEST_PATTERN` (bit 5 of the `CONTROL` register) can turn test-pattern generation on (1) or off, when the core instance Debugging Features were enabled at generation. Within the IP this switch controls multiplexers in the AXI4-Stream path, switching between the regular core processing output and the test-pattern generator. When enabled, a set of counters generate 256 scan-lines of color-bars, each color bar 64 pixels wide, repetitively cycling through Black, Red, Green, Yellow, Blue, Magenta, Cyan, and White colors till the end of each scan-line. After the Color-Bars segment, the rest of the frame is filled with a monochrome horizontal and vertical ramp.

Starting a system with all processing cores set to test-pattern mode, then by turning test-pattern generation off from the system output towards the system input allows successive bring-up and parameterization of subsequent cores.

Throughput Monitors

Throughput monitors enable the user to monitor processing performance within the core. This information can be used to help debug frame-buffer bandwidth limitation issues, and if possible, allow video application software to balance memory pathways.

Often times video systems, with multiport access to a shared external memory, have different processing islands. For example a pre-processing sub-system working in the input video clock domain may clean up, transform, and write a video stream, or multiple video streams, to memory. The processing sub-system may read the frames out, process, scale, encode, then write frames back to the frame buffer, in a separate processing clock domain. Finally, the output sub-system may format the data and read out frames locked to an external clock.

Typically, access to external memory using a multiport memory controller involves arbitration between competing streams. However, to maximize the throughput of the system, different memory ports may need different specific priorities. To fine tune the

arbitration and dynamically balance frame rates, it is beneficial to have access to throughput information measured in different video data paths.

The `SYSDEBUG0` (0x0014), or Frame Throughput Monitor, register indicates the number of frames processed since power-up or the last time the core was reset. The `SYSDEBUG1` (0x0018), or Line Throughput Monitor, register indicates the number of lines processed since power-up or the last time the core was reset. The `SYSDEBUG2` (0x001C), or Pixel Throughput Monitor, register indicates the number of pixels processed since power-up or the last time the core was reset.

Priorities of memory access points can be modified by the application software dynamically to equalize frame, or partial frame rates.

Evaluation Core Timeout

The Image Edge Enhancement hardware evaluation core times out after approximately 8 hours of operation. The output is driven to zero. This results in a dark-green screen for YUV color systems

Interfacing to Third-Party IP

[Table C-3](#) describes how to troubleshoot third-party interfaces.

Table C-3: Troubleshooting Third-Party Interfaces

Symptom	Solution
Severe color distortion or color-swap when interfacing to third-party video IP.	Verify that the color component logical addressing on the AXI4-Stream TDATA signal is in according to Data Interface in Chapter 2 . If misaligned: In HDL, break up the TDATA vector to constituent components and manually connect the slave and master interface sides. In EDK, create a new vector for the slave side TDATA connection. In the MPD file, manually assign components of the master-side TDATA vector to sections of the new vector.
Severe color distortion or color-swap when processing video written to external memory using the AXI-VDMA core.	Unless the particular software driver was developed with the AXI4-Stream TDATA signal color component assignments described in Data Interface in Chapter 2 in mind, there are no guarantees that the software will correctly identify bits corresponding to color components. Verify that the color component logical addressing TDATA is in alignment with the data format expected by the software drivers reading/writing external memory. If misaligned: In HDL, break up the TDATA vector to constituent components, and manually connect the slave and master interface sides. In EDK, create a new vector for the slave side TDATA connection. In the MPD file, manually assign components of the master-side TDATA vector to sections of the new vector.

Application Software Development

Programmer Guide

The software API is provided to allow easy access to the Image Edge Enhancement AXI4-Lite registers defined in [Table 2-9](#). To utilize the API functions, the following two header files must be included in the user C code:

```
#include "enhance.h"
#include "xparameters.h"
```

The hardware settings of your system, including the base address of your Image Edge Enhancement core, are defined in the `xparameters.h` file. The `enhance.h` file contains the macro function definitions for controlling the Image Edge Enhancement pCore.

For examples on API function calls and integration into a user application, the `drivers` subdirectory of the pCore contains a file, `example.c`, in the `enhance_v5_01_a0_a/example` subfolder. This file is a sample C program that demonstrates how to use the Image Edge Enhancement pCore API.

Table D-1: Image Edge Enhancement Driver Function Definitions

Function Name and Parameterization	Description
ENHANCE_Enable (uint32 BaseAddress)	Enables a Image Edge Enhancement instance.
ENHANCE_Disable (uint32 BaseAddress)	Disables a Image Edge Enhancement instance.
ENHANCE_Reset (uint32 BaseAddress)	Immediately resets a Image Edge Enhancement instance. The core stays in reset until the RESET flag is cleared.
ENHANCE_ClearReset (uint32 BaseAddress)	Clears the reset flag of the core, which allows it to re-sync with the input video stream and return to normal operation.
ENHANCE_FSync_Reset (uint32 BaseAddress)	Resets a Image Edge Enhancement instance at the end of the current frame being processed, or immediately if the core is not currently processing a frame.
ENHANCE_ReadReg (uint32 BaseAddress, uint32 RegOffset)	Returns the 32-bit unsigned integer value of the register. Read the register selected by RegOffset.

Table D-1: Image Edge Enhancement Driver Function Definitions (Cont'd)

Function Name and Parameterization	Description
ENHANCE_WriteReg (uint32 BaseAddress, uint32 RegOffset, uint32 Data)	Write the register selected by RegOffset. Data is the 32-bit value to write to the register.
ENHANCE_RegUpdateEnable (uint32 BaseAddress)	Enables copying double buffered registers at the beginning of the next frame. Refer to Double Buffering for more information.
ENHANCE_RegUpdateDisable (uint32 BaseAddress)	Disables copying double buffered registers at the beginning of the next frame. Refer to Double Buffering for more information.

Software Reset

Software reset reinitializes registers of the AXI4-Lite control interface to their initial value, resets FIFOs, forces `m_axis_video_tvalid` and `s_axis_video_tready` to 0.

`ENHANCE_Reset()` and `ENHANCE_FSync_Reset()` reset the core immediately if the core is not currently processing a frame. If the core is currently processing a frame calling `ENHANCE_Reset()`, or setting bit 30 of the `CONTROL` register to 1 will cause image tearing. After calling `ENHANCE_Reset()`, the core remains in reset until `ENHANCE_ClearReset()` is called.

Calling `ENHANCE_FSync_Reset()` automates this reset process by waiting until the core finishes processing the current frame, then asserting the reset signal internally, keeping the core in reset only for 32 `ACLK` cycles, then deasserting the signal automatically. After calling `ENHANCE_FSync_Reset()`, it is not necessary to call `ENHANCE_ClearReset()` for the core to return to normal operating mode.



IMPORTANT: *Calling `ENHANCE_FSync_Reset()` does not guarantee prompt, or real-time resetting of the core. If the AXI4-Stream communication is halted mid frame, the core will not reset until the upstream core finishes sending the current frame or starts a new frame.*

Double Buffering

Registers `GAIN_H`, `GAIN_V`, `GAIN_D`, `GAIN_LAP`, and `ACTIVE_SIZE` are double-buffered to ensure no image tearing happens if values are modified during frame processing. Values from the AXI4-Lite interface are latched into processor registers immediately after writing, and processor register values are copied into the active register set at the Start Of Frame (SOF) signal. Double-buffering decouples AXI4-Lite register updates from the AXI4-Stream processing, allowing software a large window of opportunity to update processing parameter values without image tearing.

If multiple register values are changed during frame processing, simple double buffering would not guarantee that all register updates would take effect at the beginning of the same frame. Using a semaphore mechanism, the `RegUpdateEnable()` and

`RegUpdateDisable()` functions allows synchronous commitment of register changes. The Image Edge Enhancement core will start using the updated `ACTIVE_SIZE` and `GAIN` values only if the `REGUPDATE` flag of the `CONTROL` register is set (1), after the next Start-Of-Frame signal (`s_axis_video_tuser`) is received. Therefore, it is recommended to disable the register update before writing multiple double-buffered registers, then enable register update when register writes are completed.

Reading and Writing Registers

Each software register that is defined in [Table 2-12](#) has a constant that is defined in `enhance.h` which is set to the offset for that register listed in [Table D-2](#).



RECOMMENDED: Use the predefined register names instead of register values in the application software when accessing core registers. This will prevent any future updates to the Image Edge Enhancement drivers which may change register locations from negatively affecting the application dependent on the Image Edge Enhancement driver.

Table D-2: Predefined Constants Defined in `enhance.h`

Constant Name Definition	Value	Target Register
<code>ENHANCE_CONTROL</code>	0x0000	<code>CONTROL</code>
<code>ENHANCE_STATUS</code>	0x0004	<code>STATUS</code>
<code>ENHANCE_ERROR</code>	0x0008	<code>ERROR</code>
<code>ENHANCE_IRQ_ENABLE</code>	0x000C	<code>IRQ_ENABLE</code>
<code>ENHANCE_VERSION</code>	0x0010	<code>VERSION</code>
<code>ENHANCE_SYSDEBUG0</code>	0x0014	<code>SYSDEBUG0</code>
<code>ENHANCE_SYSDEBUG1</code>	0x0018	<code>SYSDEBUG1</code>
<code>ENHANCE_SYSDEBUG2</code>	0x001C	<code>SYSDEBUG2</code>
<code>ENHANCE_ACTIVE_SIZE</code>	0x0020	<code>ACTIVE_SIZE</code>
<code>ENHANCE_GAIN_H</code>	0x0100	<code>GAIN_H</code>
<code>ENHANCE_GAIN_V</code>	0x0104	<code>GAIN_V</code>
<code>ENHANCE_GAIN_D</code>	0x0108	<code>GAIN_D</code>
<code>ENHANCE_GAIN_LAP</code>	0x010C	<code>GAIN_LAP</code>

Additional Resources

Xilinx Resources

For support resources such as Answers, Documentation, Downloads, and Forums, see the Xilinx Support website at:

<http://www.xilinx.com/support>.

For a glossary of technical terms used in Xilinx documentation, see:

http://www.xilinx.com/support/documentation/sw_manuals/glossary.pdf.

For a comprehensive listing of Video and Imaging application notes, white papers, reference designs and related IP cores, see the Video and Imaging Resources page at:

http://www.xilinx.com/esp/video/refdes_listing.htm#ref_des.

Solution Centers

See the [Xilinx Solution Centers](#) for support on devices, software tools, and intellectual property at all stages of the design cycle. Topics include design assistance, advisories, and troubleshooting tips.

References

These documents provide supplemental material useful with this user guide:

1. [UG761 AXI Reference Guide](#)
2. [Vivado Design Suite Migration Methodology Guide](#) (UG911)
3. [Vivado™ Design Suite user documentation](#)

Technical Support

Xilinx provides technical support at www.xilinx.com/support for this LogiCORE™ IP product when used as described in the product documentation. Xilinx cannot guarantee timing, functionality, or support of product if implemented in devices that are not defined in the documentation, if customized beyond that allowed in the product documentation, or if changes are made to any section of the design labeled DO NOT MODIFY.

See the IP Release Notes Guide ([XTP025](#)) for more information on this core. For each core, there is a master Answer Record that contains the Release Notes and Known Issues list for the core being used. The following information is listed for each version of the core:

- New Features
- Resolved Issues
- Known Issues

Revision History

The following table shows the revision history for this document.

Date	Version	Revision
10/19/2011	1.0	Initial Xilinx release of Product Guide, replacing DS753 and UG831.
4/24/2012	2.0	Updated for core version. Added Zynq-7000 devices, added AXI4-Stream interfaces, deprecated GPP interface.
07/25/2012	3.0	Updated for core version. Added Vivado information.
10/16/2012	3.1	Updated for core version and ISE 14.3 and Vivado 2012.3 design tools. Added Vivado test bench.

Notice of Disclaimer

The information disclosed to you hereunder (the "Materials") is provided solely for the selection and use of Xilinx products. To the maximum extent permitted by applicable law: (1) Materials are made available "AS IS" and with all faults, Xilinx hereby DISCLAIMS ALL WARRANTIES AND CONDITIONS, EXPRESS, IMPLIED, OR STATUTORY, INCLUDING BUT NOT LIMITED TO WARRANTIES OF MERCHANTABILITY, NON-INFRINGEMENT, OR FITNESS FOR ANY PARTICULAR PURPOSE; and (2) Xilinx shall not be liable (whether in contract or tort, including negligence, or under any other theory of liability) for any loss or damage of any kind or nature related to, arising under, or in connection with, the Materials (including your use of the Materials), including for any direct, indirect, special, incidental, or consequential loss or damage (including loss of data, profits, goodwill, or any type of loss or damage suffered as a result of any action brought by a third party) even if such damage or loss was reasonably foreseeable or Xilinx had been advised of the possibility of the same. Xilinx assumes no obligation to correct any errors contained in the Materials or to notify you of updates to the Materials or to product specifications. You may not reproduce, modify, distribute, or publicly display the Materials without prior written consent. Certain products are subject to the terms and conditions of the Limited Warranties which can be viewed at <http://www.xilinx.com/warranty.htm>; IP cores may be subject to warranty and support terms contained in

a license issued to you by Xilinx. Xilinx products are not designed or intended to be fail-safe or for use in any application requiring fail-safe performance; you assume sole risk and liability for use of Xilinx products in Critical Applications: <http://www.xilinx.com/warranty.htm#critapps>.

© Copyright 2011–2012 Xilinx, Inc. Xilinx, the Xilinx logo, Artix, ISE, Kintex, Spartan, Virtex, Zynq, and other designated brands included herein are trademarks of Xilinx in the United States and other countries. All other trademarks are the property of their respective owners.