

LogiCORE IP 10-Gigabit Ethernet PCS/PMA v2.4

Product Guide

PG068 July 25, 2012

Table of Contents

SECTION I: SUMMARY

IP Facts

Chapter 1: Overview

System Requirements	9
Recommended Design Experience	10
Applications	10
Unsupported Features.....	11
Licensing and Ordering Information.....	12

Chapter 2: Product Specification

Standards Compliance.....	13
Performance.....	13
Resource Utilization.....	15
Port Descriptions	16
Miscellaneous Signals - Virtex-7/Kintex-7 FPGAs	23
Register Space	24

Chapter 3: Designing with the Core

General Design Guidelines	78
Interfacing to the Core.....	79
Clocking.....	95
Resets	97
Receiver Termination.....	98

SECTION II: VIVADO DESIGN SUITE

Chapter 4: Customizing and Generating the Core

GUI	100
Output Generation.....	101

Chapter 5: Constraining the Core

Required Constraints.....	102
Device, Package, and Speed Grade Selections.....	102
Clock Frequencies	102
Clock Management	104
Clock Placement.....	104
Banking.....	104
Transceiver Placement	105
I/O Standard and Placement.....	105

Chapter 6: Detailed Example Design

Example Design	106
Demonstration Test Bench	107
Implementation	108
Simulation	108

SECTION III: ISE DESIGN SUITE

Chapter 7: Customizing and Generating the Core

GUI	110
Parameter Values in the XCO File.....	111
Output Generation.....	112

Chapter 8: Constraining the Core

Required Constraints.....	119
Device, Package, and Speed Grade Selections.....	119
Clock Frequencies	120
Clock Management	121
Clock Placement.....	121
Banking.....	121
Transceiver Placement	122
I/O Standard and Placement.....	122

Chapter 9: Detailed Example Design

Directory and File Contents	123
Example Design	123
Demonstration Test Bench	125
Implementation	126
Simulation	127

SECTION IV: APPENDICES

Appendix A: Verification, Compliance, and Interoperability

Simulation	130
Hardware Testing	131
Compliance Testing	131

Appendix B: Debugging

Appendix C: Migrating

Parameter Changes in the XCO File	133
Port Changes	133
Functionality Changes	133

Appendix D: Special Design Considerations

Connecting Multiple Core Instances	134
Using the DRP in Virtex-6 HXT FPGAs	136

Appendix E: Additional Resources

Xilinx Resources	137
Solution Centers	137
References	137
Technical Support	138
Revision History	138
Notice of Disclaimer	138

SECTION I: SUMMARY

IP Facts

Overview

Product Specification

Designing with the Core

Introduction

The LogiCORE™ IP 10-Gigabit Ethernet Physical Coding Sublayer/Physical Medium Attachment (PCS/PMA) core, also known as 10GBASE-R in this document, forms a seamless interface between the Xilinx 10-Gigabit Ethernet Media Access Controller (MAC) and a 10 Gb/s-capable PHY, enabling the design of high-speed Ethernet systems and subsystems.

10GBASE-KR and 10GBASE-R are supported on Virtex®-7 and Kintex™-7 devices on GTH and GTX transceivers. Xilinx also supports an integrated 10GBASE-R IP on Virtex-6 HXT devices. 10GBASE-KR for backplane applications has additional features over 10GBASE-R which consist of Link Training and optional Forward Error Correction (FEC) and Auto-negotiation (AN).

Features

- Designed to 10-Gigabit Ethernet specification IEEE 802.3-2008 clause 49, 72, 73, 74
- Optional Management Data Interface (MDIO) interface to manage PCS/PMA registers according to specification IEEE 802.3-2008 clause 45
- Delivered through the Xilinx CORE Generator™ and Vivado™ IP Catalog tools
- Supports 10GBASE-SR, -LR and -ER optical links in Virtex-7, Kintex-7 and Virtex-6 devices (LAN mode only)
- Supports 10GBASE-KR backplane links in Kintex-7/Virtex-7, including Auto-Negotiation (AN), Training and Forward Error Correction (FEC).
- SDR 10-Gigabit Ethernet Media Independent Interface (XGMII) connects seamlessly to the Xilinx 10G Ethernet MAC

LogiCORE IP Facts Table	
Core Specifics	
Supported Device Family ⁽¹⁾	Virtex-7, Kintex-7 ⁽²⁾ , Virtex-6 HXT
Supported User Interfaces	XGMII
Resources	See Table 2-1 through Table 2-3 .
Provided with Core	
Design Files	ISE®: Native Generic Circuit (NGC) Netlist Vivado™: Encrypted RTL
Example Design	Verilog and VHDL
Test Bench	Verilog and VHDL
Constraints File	ISE: Xilinx Constraints File Vivado: Xilinx Design Constraint (XDC)
Simulation Model	Verilog or VHDL Structural Model
Supported S/W Driver	N/A
Tested Design Flows⁽³⁾	
Design Entry	ISE Design Suite 14.2 Vivado Design Suite 2012.2 ⁽⁴⁾
Simulation	Mentor Graphics ModelSim Cadence Incisive Enterprise Simulator (IES) Synopsys VCS and VCS MX
Synthesis	XST Vivado Synthesis
Support	
Provided by Xilinx @ www.xilinx.com/support	

Notes:

1. For a complete listing of supported devices, see the [release notes](#) for this core.
2. -2, -2L or -3.
3. For the supported versions of the tools, see the [Xilinx Design Tools: Release Notes Guide](#).
4. Supports only 7 series devices.

Overview

10GBASE-R/KR is a 10 Gb/s serial interface. It is intended to provide the Physical Coding Sublayer (PCS) and Physical Medium Attachment (PMA) functionality between the 10-Gigabit Media Independent Interface (XGMII) interface on a Ten Gigabit Ethernet Media Access Controller (MAC) and a Ten Gigabit Ethernet network physical-side interface (PHY).

What distinguishes the 10GBASE-KR core from the 10GBASE-R core is that the 10GBASE-KR core includes a Link Training block as well as optional Auto-negotiation (AN) and Forward Error Correction (FEC) features, all to help support a 10 Gb/s data stream across a backplane. The 10GBASE-R core is not suitable for use with backplanes.

10GBASE-R

Figure 1-2 illustrates a block diagram of the 10-Gigabit Ethernet PCS/PMA (BASE-R) core implementation on Virtex®-6 devices. As you can see, in Virtex-6 devices, most of the functionality is contained within the GTHE1 transceiver.

For Virtex-7/Kintex™-7 devices, all of the PCS and Management blocks illustrated are implemented in logic, except for part of the Gearbox and SERDES. Figure 1-1 shows the architecture.

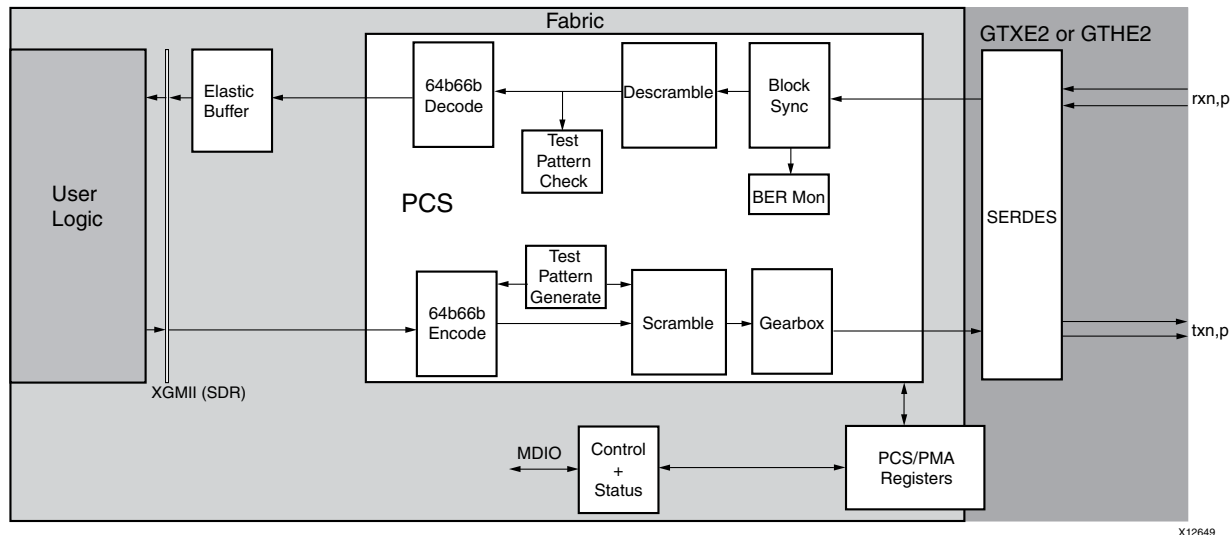

Figure 1-1: Virtex-7/Kintex-7 Implementation of the 10-Gigabit Ethernet PCS/PMA (BASE-R) Core

The major functional blocks of the core include the following:

- XGMII interface, designed for simple attachment of 10-Gigabit Ethernet MAC
- Transmit path, including Scrambler, 64B/66b Encoder and Gearbox
- Receive path, including Block Synchronization, Descrambler, Decoder and BER (Bit Error Rate) monitor
- Test Pattern Generation and Checking
- Serial interface to optics
- Management registers (PCS/PMA) with optional MDIO interface

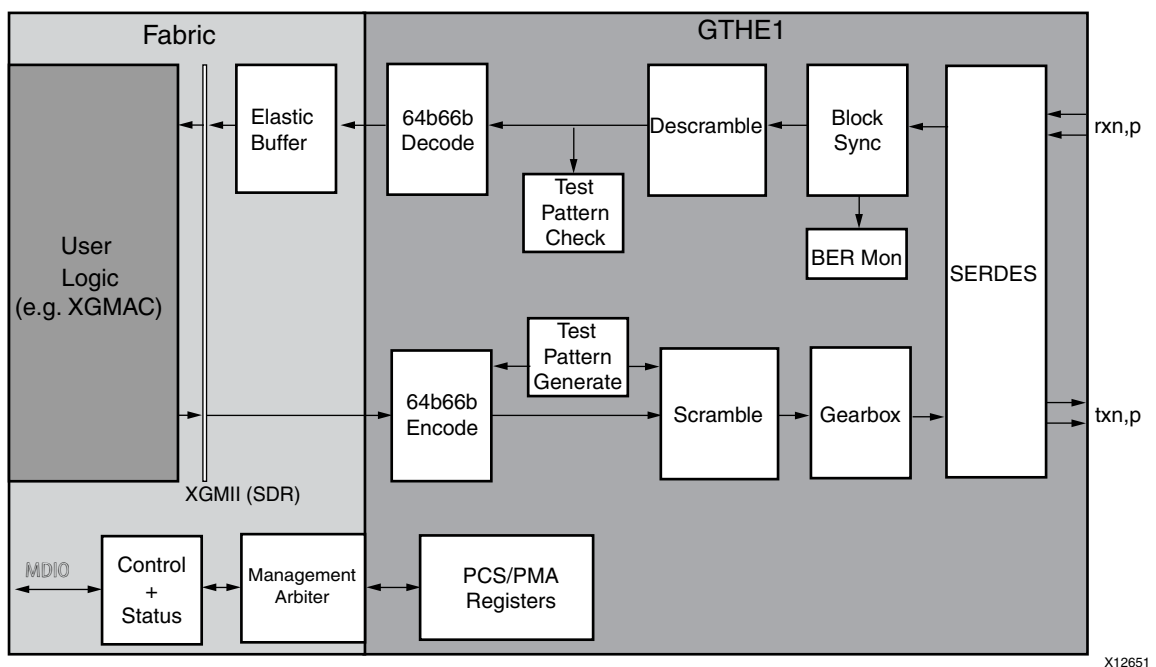

Figure 1-2: Virtex-6 Implementation of the BASE-R Core

X12651

10GBASE-KR

Figure 1-3 illustrates a block diagram of the 10-Gigabit Ethernet PCS/PMA (BASE-KR) core implementation. The major functional blocks of the core include the following:

- XGMII interface, designed for simple attachment of 10-Gigabit Ethernet MAC
- Transmit path, including Scrambler, 64B/66B Encoder, FEC, AN and Training
- Receive path, including Block Synchronization, Descrambler, Decoder and BER (Bit Error Rate) monitor, FEC, AN and Training
- Test Pattern Generation and Checking
- Serial interface to backplane connector
- Management registers (PCS/PMA) with optional MDIO interface

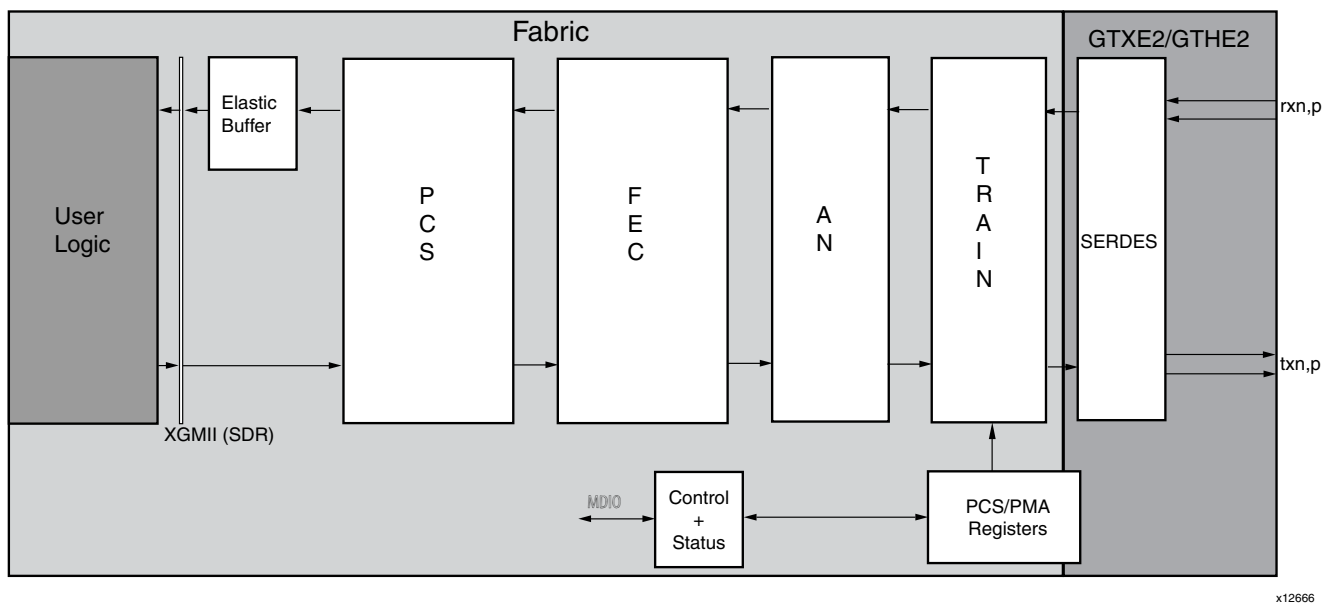

Figure 1-3: Virtex-7/Kintex-7 Implementation of the BASE-KR Core

System Requirements

For a list of System Requirements, see the [Xilinx Design Tools: Release Notes Guide](#).

Recommended Design Experience

Although the core is a fully-verified solution, the challenge associated with implementing a complete design varies depending on the configuration and functionality of the application. For best results, previous experience building high performance, pipelined Field Programmable Gate Array (FPGA) designs using Xilinx implementation software and User Constraints File (UCF) or Xilinx Design Constraints (XDC) is recommended.

Contact your local Xilinx representative for a closer review and estimation for your specific requirements.

Applications

Figure 1-4 shows a typical Ethernet system architecture and the 10-Gigabit Ethernet PCS/PMA core within it. The MAC and all the blocks to the right are defined in Ethernet IEEE specifications [Ref 1][Ref 2].

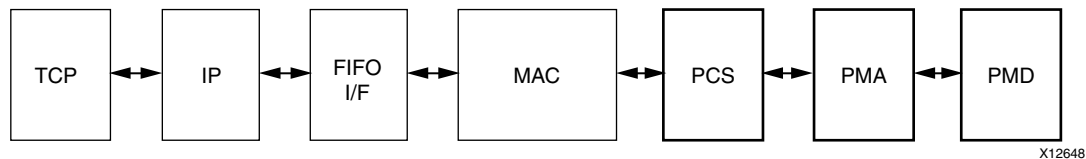

Figure 1-4: Typical Ethernet System Architecture

Figure 1-5 shows the 10-Gigabit Ethernet PCS/PMA core connected on one side to a 10-Gigabit MAC and on the other to an optical module (BASE-R) or backplane (BASE-KR) using a serial interface. The optional WAN Interface Sublayer (WIS) part of the 10GBASE-R standard is not implemented in this core.

The 10-Gigabit Ethernet PCS/PMA core is designed to be attached to the Xilinx IP 10-Gigabit Ethernet MAC core over XGMII. More details are provided in [Chapter 3, Designing with the Core](#).

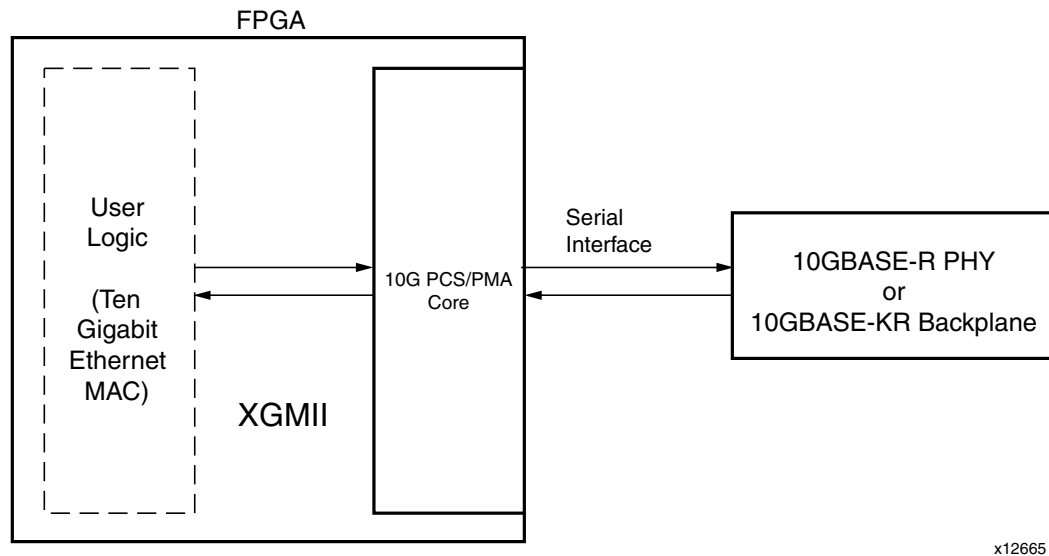

Figure 1-5: Core Connected to MAC Core Using XGMII Interface

Unsupported Features

While the Training Protocol is supported natively by the core, no logic is provided that controls the far-end transmitter adaptation based on analysis of the received signal quality.

However, an interface is provided on the core that allows access to all core registers and to the DRP port on the transceiver. You can employ this interface to implement your own Training Algorithm for 10GBASE-KR, if required.

Licensing and Ordering Information

The section contains the following subsections.

- [10GBASE-R PCS/PMA](#)
- [10 Gigabit Ethernet PCS/PMA with FEC/Auto-Negotiation \(10GBASE-KR\)](#)

10GBASE-R PCS/PMA

This Xilinx LogiCORE™ IP module is provided at no additional cost with the Xilinx Vivado™ Design Suite and ISE® Design Suite tools under the terms of the [Xilinx End User License](#). Information about this and other Xilinx LogiCORE IP modules is available at the [Xilinx Intellectual Property](#) page. For information about pricing and availability of other Xilinx LogiCORE IP modules and tools, contact your [local Xilinx sales representative](#).

For more information, visit the 10 Gigabit Ethernet PCS/PMA (10GBASE-R) [product web page](#).

10 Gigabit Ethernet PCS/PMA with FEC/Auto-Negotiation (10GBASE-KR)

This Xilinx LogiCORE IP module is provided under the terms of the [Xilinx Core License Agreement](#). The module is shipped as part of the Vivado Design Suite and ISE Design Suite. For full access to all core functionalities in simulation and in hardware, you must purchase a license for the core. Contact your [local Xilinx sales representative](#) for information about pricing and availability.

For more information, visit the 10 Gigabit Ethernet PCS/PMA with FEC/Auto-Negotiation (10GBASE-KR) [product web page](#).

Information about other Xilinx LogiCORE IP modules is available at the [Xilinx Intellectual Property](#) page. For information on pricing and availability of other Xilinx LogiCORE IP modules and tools, contact your [local Xilinx sales representative](#).

Product Specification

Standards Compliance

The 10GBASE-R/KR core is designed to the standard specified in clauses 45, 49, 72, 73 and 74 of the 10-Gigabit Ethernet specification IEEE Std. 802.3-2008.

Performance

Latency

These measurements are for the core only; they do not include the latency through the transceiver. The latency through the transceiver can be obtained from the relevant user guide.

Virtex-7/Kintex-7 FPGAs

Transmit Path Latency

As measured from the input port `xgmii_txd[63:0]` of the transmitter side XGMII (until that data appears on `gt_txd[31:0]` on the transceiver interface), the latency through the core for the internal XGMII interface configuration in the transmit direction is 20 periods of `txclk322`. When the optional FEC functionality is included in the core, this increases to 26 periods of `txclk322`.

Receive Path Latency

Measured from the input into the core on `gt_rxd[31:0]` until the data appears on `xgmii_rxd[63:0]` of the receiver side XGMII interface, the latency through the core in the receive direction is nominally equal to 28 cycles of `rxclk322`, including +/- 4 cycles in the elastic buffer. The latency depends on sync bit alignment position and data positioning within the transceiver 4-byte interface. When the optional FEC functionality is included in the core, this increases by 70 cycles of `rxclk322` and if error reporting to the PCS layer is enabled then there will be an extra 66 cycles of `rxclk322` latency.

Transceiver Latency

See *7 Series Transceivers User Guide* (UG476) for information on the transceiver latency.

Virtex-6 HXT FPGAs

Transmit Path Latency

As measured from the input port `xgmii_txd[63:0]` of the transmitter side XGMII (until that data appears on `gt_txd[63:0]` on the transceiver interface), the latency through the core for the internal XGMII interface configuration in the transmit direction is 2 periods of the core input `clk156`.

Receive Path Latency

Measured from the input into the core on `gt_rxd[63:0]` until the data appears on `xgmii_rxd[63:0]` of the receiver side XGMII interface, the latency through the core in the receive direction is nominally equal to 10 clock cycles of `clk156`, +/- 4 cycles in the elastic buffer. The latency depends on sync bit alignment position and data positioning within the transceiver 4-byte interface.

GTH Transceiver Latency

Latency through the GTH transceiver in the transmit direction is nominally 5 cycles of `clk156`.

Latency through the GTH transceiver in the receive direction is nominally 3 cycles of `rxclk156` plus a number of bit-times between zero and 65, in the RX Alignment Buffer.

Total Latency

The total latency from `xgmii_tx` to `xgmii_rx` if the core is looped back at the serial ports is $(1320 + 0.65)$ Bit Times (BT). This meets the IEEE specification in clause 49.3.6.4 of a maximum of 3586 BT.

With the Rx Elastic Buffer at its maximum fill level, the overall latency is $(1584 + 0.65)$ BT.

Resource Utilization

Virtex-7/Kintex-7 FPGAs

Table 2-1 provides approximate slice counts for the BASE-R options on Virtex®-7 and Kintex™-7 FPGAs.

Table 2-1: Device Utilization - BASE-R on Virtex-7/Kintex-7 FPGAs

Parameter Values	Device Resources		
MDIO Interface	Slices	LUTs	FFs
No	952	2160	2281
Yes	1171	2736	2708

Table 2-2 provides the approximate slice counts for the BASE-KR options on Virtex-7 and Kintex-7 FPGAs.

Table 2-2: Device Utilization on Virtex-7/Kintex-7 FPGAs

Parameter Values			Device Resources		
FEC	Auto-Negotiation	MDIO Interface	Slices	LUTs	FFs
No	No	No	1549	3318	3494
No	No	Yes	1709	3745	3734
No	Yes	No	1797	3815	4100
No	Yes	Yes	1972	4504	4517
Yes	No	No	2854	6899	5176
Yes	No	Yes	2886	7372	5446
Yes	Yes	No	3343	7465	5806
Yes	Yes	Yes	3443	8191	6200

Virtex-6 HXT FPGAs

Table 2-3 provides approximate slice counts for the two BASE-R core options on Virtex-6 HXT FPGAs.

Table 2-3: Device Utilization - Virtex-6 HXT FPGAs

Parameter Values	Device Resources		
MDIO Interface	Slices	LUTs	FFs
No	446	877	1019
Yes	296	687	770

Port Descriptions

MAC-Side Interface: XGMII

The MAC (or client) side of the core has a 64-bit datapath plus 8 control bits implementing an XGMII interface. Table 2-4 defines the signals, which are all synchronous to the 156.25 MHz core clock. It is designed to be connected to either user logic within the FPGA or, by using SelectIO™ technology Double Data Rate (DDR) registers in the user’s own design top-level, to provide an external 32-bit 312.5 Mb/s DDR XGMII, defined in clause 46 of IEEE 802.3-2008.

Table 2-4: MAC-Side Interface Ports

Signal Name	Direction	Description
xgmii_txd[63:0]	In	64-bit transmit data word
xgmii_txc[7:0]	In	8-bit transmit control word
xgmii_rxd[63:0]	Out	64-bit receive data word
xgmii_rxc[7:0]	Out	8-bit receive control word

Figure 2-1 illustrates transmitting a frame through the client-side interface.

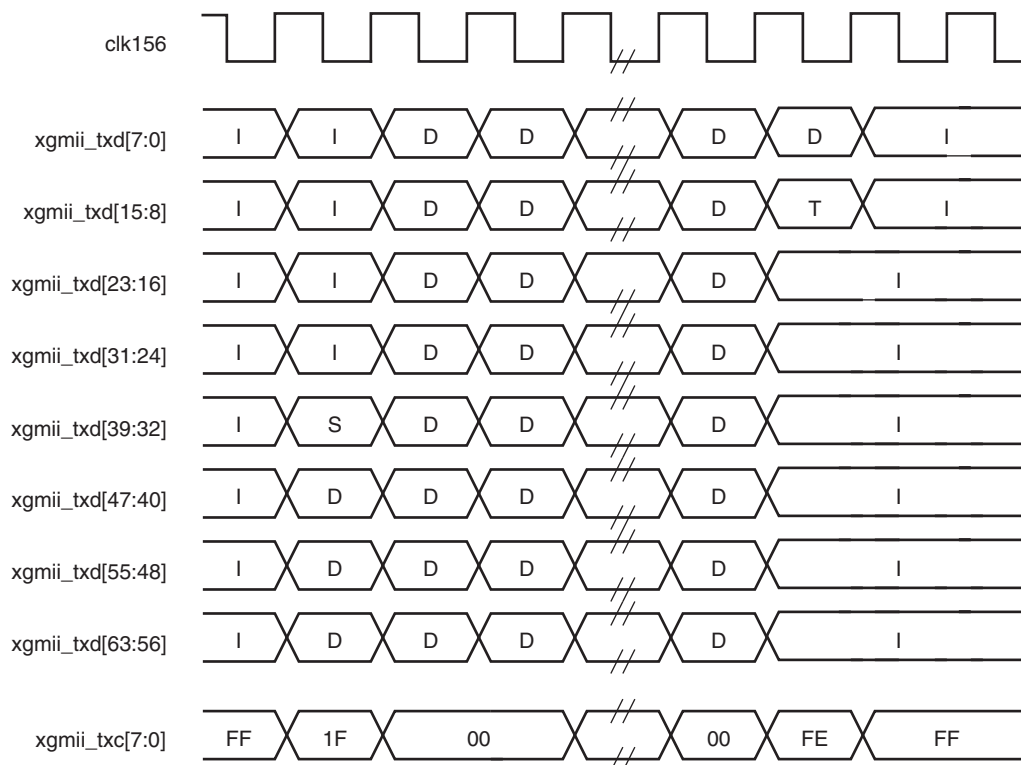

Figure 2-1: Transmitting a Frame Through the Client-Side Interface

Figure 2-2 illustrates receiving a frame through the client-side interface.

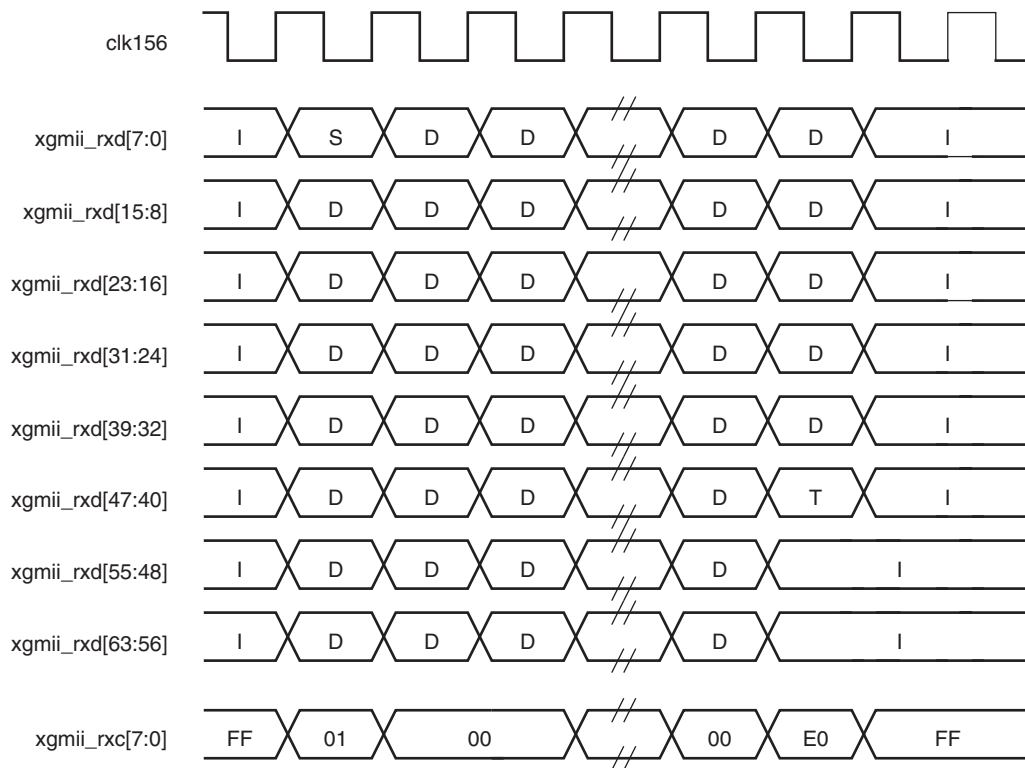

Figure 2-2: Receiving a Frame Through the Client-Side Interface

Transceiver Data Interface - Virtex-7/Kintex-7 FPGA GTX/GTH Transceiver

The interface to the device-specific transceivers is not a simple one-to-one interface on those pins that need to be connected. The signals are described in Table 2-5. See Chapter 3, Designing with the Core for details on connecting the device-specific transceivers to the 10GBASE-R/KR core. The `gt_txc[7:2]` on the core should be connected to `txsequence[5:0]` on the transceiver and `gt_rxc[2]` and `gt_rxc[3]` on the core should be connected to `rxdatavalid` and `rxheadervalid` on the transceiver.

Table 2-5: Transceiver Interface Ports - Virtex-7/Kintex-7 FPGA GTX/GTH Transceiver

Signal Name	Direction	Description
gt_txd[31:0]	Out	32-bit transmit data word
gt_txc[1:0]	Out	2-bit transmit sync header
gt_txc[7:2]	Out	6-bit TXSEQUENCE count (0..32)
gt_rxd[31:0]	In	32-bit receive data word
gt_rxc[1:0]	In	2-bit receive sync header
gt_rxc[2]	In	RXDATAVALID (high for 64 in 66 rxusrclk2 cycles)

Table 2-5: Transceiver Interface Ports - Virtex-7/Kintex-7 FPGA GTX/GTH Transceiver (Cont'd)

Signal Name	Direction	Description
gt_rxc[3]	In	RXHEADERVALID (high on alternating cycles of rxusrclk2, while RXDATAVALID is also high)
gt_rxc[7:4]	In	Not Used
gt_slip	Out	RXGEARBOXSLIP

Transceiver Data Interface - Virtex-6 FPGA GTH Transceiver

The interface to the device-specific transceivers is a simple pin-to-pin interface on those pins that need to be connected. The signals are described in Table 2-6. See Chapter 3, [Designing with the Core](#) for details on connecting the device-specific transceivers to the 10GBASE-R core.

Table 2-6: Transceiver Interface Ports - Virtex-6 FPGA GTH Transceiver

Signal Name	Direction	Description
gt_txd[63:0]	OUT	Transceiver transmit data
gt_txc[7:0]	OUT	Transceiver transmit control flag
gt_rxd[63:0]	IN	Transceiver receive data
gt_rxc[7:0]	IN	Transceiver receive control signals

Optical Module Interface

The status and control interface to an attached optical module is a simple pin-to-pin interface on those pins that need to be connected. The signals are described in Table 2-6. See Chapter 3, [Designing with the Core](#) for details on connecting an optical module to the 10GBASE-R core.

Table 2-7: Optical Module Interface Ports

Signal Name	Direction	Description
signal_detect	IN	Status signal from attached optical module ^a
tx_fault	IN	Status signal from attached optical module ^{ab}
tx_disable	OUT	Control signal to attached optical module

a. These signals are not connected inside this version of the core. It is left to users to handle these inputs and reset their design as they see fit.

b. Connect to SFP+ tx_fault signal, or XFP MOD_NR signal, depending on which is present.

Management Interface (MDIO)

The optional MDIO interface is a simple low-speed two-wire interface for management of the 10-Gigabit Ethernet PCS/PMA core, consisting of a clock signal and a bidirectional data signal. The interface is defined in clause 45 of the *IEEE 802.3-2008* standard.

In this core, the MDIO interface is an optional block. If implemented, the bidirectional data signal MDIO is implemented as three unidirectional signals. These can be used to drive a 3-state buffer either in the FPGA IOB or in a separate device.

For the BASE-R core in Virtex-6 FPGAs, the appropriate register in the GTHE1 transceiver is pre-read as soon as the address phase of the MDIO transfer is complete and this data is provided back to the MDIO interface on completion of the READ phase of the MDIO transfer.

Table 2-8: MDIO Management Interface Ports

Signal Name	Direction	Description
mdc	In	Management clock
mdio_in	In	MDIO Input
mdio_out	Out	MDIO Output
mdio_tri	Out	MDIO 3-state control. "1" disconnects the output driver from the MDIO bus.
prtad[4:0]	In	MDIO port address. When multiple MDIO-managed ports appear on the same bus, this input can be used to set the address of each port.

GTHE1 Management Interface Ports

There is a management interface on the GTHE1 transceiver which connects to the associated ports on the core, through an arbiter block provided with the core.

Table 2-9: GTHE1 Management Interface Ports

Signal Name	Direction	Description
mgmt_req	Out	Request access to the MGMT interface on the GTHE1
mgmt_gnt	In	Access granted to the MGMT interface on the GTHE1
mgmt_rd_out	Out	Read enable
mgmt_wr_out	Out	Write enable
mgmt_addr_out[20:0]	Out	Address
mgmt_rdock_in	In	Read Acknowledge
mgmt_rddata_in[15:0]	In	Read data
mgmt_wrdata_out[15:0]	In	Write data

GTXE2/GTHE2 DRP Interface Ports

There is a DRP interface on the GTXE2/GTHE2 transceivers which connect to the associated ports on the core, perhaps through an arbiter block (not provided with the core).

Table 2-10: GTXE2/GTHE2 DRP Interface Ports

Signal Name	Direction	Description
drp_req ^a	Out	Request access to the DRP interface on the GTXE2/GTHE2
drp_gnt	In	Access granted to the DRP interface on the GTXE2/GTHE2
drp_den	Out	DRP enable
drp_dwe	Out	Write enable
drp_daddr[15:0]	Out	Address
drp_di[15:0]	In	Write data
drp_drdy	In	Read data ready/Write complete
drp_drpdo[15:0]	In	Read data

a. Can be wired directly to drp_gnt if this is the only block requiring access to the DRP interface.

Configuration and Status Signals

As an alternative to the MDIO interface, vector-based interfaces are provided to allow control and status to flow to and from the core. Table 2-11 describes these two vectors. Neither vector is completely populated so the actual number of pins required is much lower than the maximum widths of the vectors. For the status vector, correct default values are provided for all bits in the associated IEEE registers. Further details of these vectors can be found in Table 3-6 to Table 3-9.

Table 2-11: Configuration and Status Vectors

Signal Name	Direction	Description
configuration_vector[535:0]	In	Configures the PCS/PMA registers
status_vector[447:0]	Out	Reflects <i>recent</i> status of PCS/PMA registers

Clocking and Reset Signals - Virtex-7/Kintex-7 FPGAs

Included in the example design top-level sources are circuits for clock and reset management. These can include clock generators, reset synchronizers, or other useful utility circuits that can be useful in your particular application.

Table 2-12 shows the ports on the netlist that are associated with system clocks and resets.

Table 2-12: Clock and Reset Ports- Virtex-7/Kintex-7

Signal Name	Direction	Description
clk156	IN	System clock for core
rxusrclk2	IN	Receive path clock, derived from recovered clock on the GTX/GTH transceiver
txusrclk2	IN	Transmit path clock, derived from TXCLKOUT on the GTX/GTH transceiver
dclk	IN	Management/DRP clock, at half the rate of clk156
reset	IN	Synchronous reset in clk156 domain
rxreset322	IN	Synchronous reset in rxusrclk2 domain
txreset322	IN	Synchronous reset in txusrclk2 domain
dclk_reset	IN	Synchronous reset in dclk domain
pma_resetout	OUT	Reset signal from core to transceiver
pcs_resetout	OUT	Reset signal from core to transceiver
resetdone	IN	Signal from transceiver to core - the requested reset is complete

Clocking and Reset Signals - Virtex-6 FPGAs

Included in the example design top-level sources are circuits for clock and reset management. These can include clock generators, reset synchronizers, or other useful utility circuits that can be useful in your particular application.

[Table 2-13](#) shows the ports on the netlist that are associated with system clocks and resets.

Table 2-13: Clock and Reset Ports - Virtex-6 FPGAs

Signal Name	Direction	Description
clk156	IN	System clock for core.
rxclk156	IN	Receiver clock to transceiver side of elastic buffer.
dclk	IN	Management clock used to access transceiver registers.
reset	IN	Reset port synchronous to clk156.

Training Interface - Virtex-7/Kintex-7 FPGAs, BASE-KR Only

In the 7 series devices, an external Training Algorithm must be connected to the Training Interface, which allows access to both the 802.3 registers in the core and the DRP registers in the GTX/GTH transceiver. [Table 2-14](#) shows the ports on the netlist that are associated with that interface.

Table 2-14: Training Interface Ports - Virtex-7/Kintex-7 FPGAs, BASE-KR Only

Signal Name	Direction	Description
training_enable	in	Signal from external Training Algorithm to enable the training interface
training_addr[20:0]	in	Register address from Training Algorithm - bits [20:16] are the DEVAD for 802.3 registers
training_rnw	in	Read/Write_bar signal from Training Algorithm
training_ipif_cs	in	Select access to 802.3 registers in the core ⁽¹⁾
training_drp_cs	in	Select access to DRP registers in the GTX/GTH transceiver
training_rddata[15:0]	out	Read data from DRP or 802.3 registers
training_rdack	out	Read Acknowledge signal to external Training Algorithm
training_wrack	out	Write Acknowledge signal to external Training Algorithm

1. This signal has no meaning or effect when the core is created without an MDIO interface since all registers are exposed through the configuration and status vectors. This should be tied to '0' in that case. Access to transceiver DRP registers through the Training interface is unaffected.

Figure 2-3 and Figure 2-4 show the timing diagrams for Using the Training Interface to Access Internal Core Registers and Transceiver Registers via the DRP Port. As shown in Figure 2-3 and Figure 2-4, training_drp_cs, training_ipif_cs, and training_enable should be low between read or write accesses.

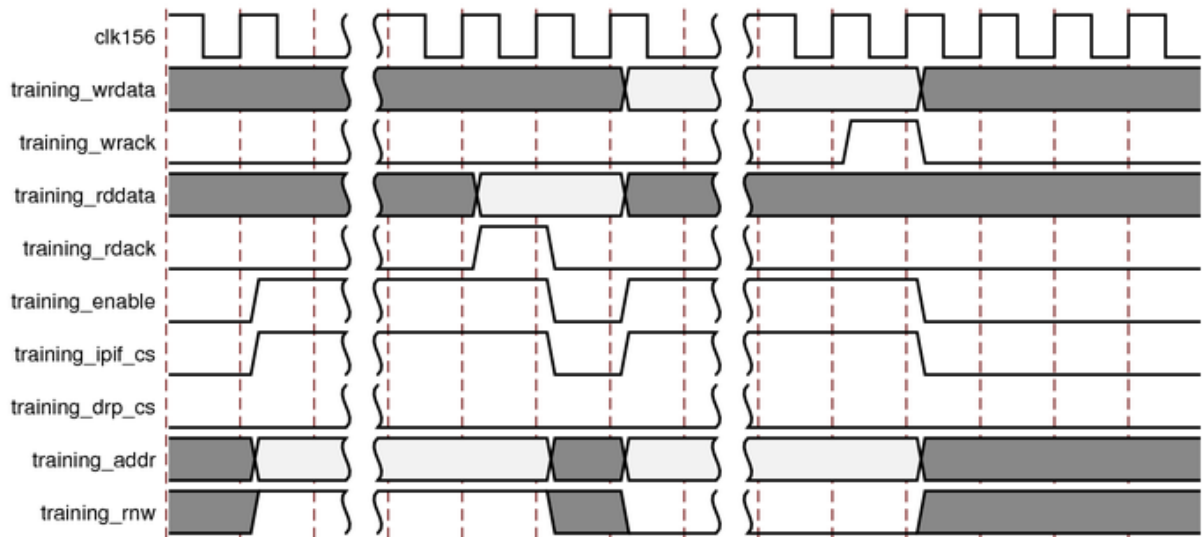

Figure 2-3: Using the Training Interface to Access Internal Core Registers

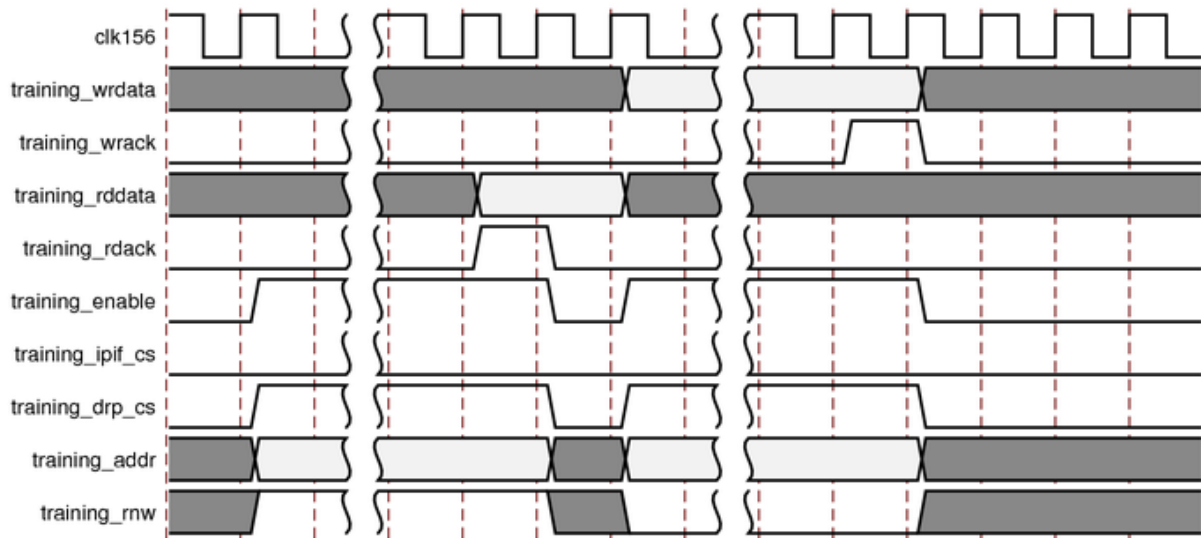

Figure 2-4: Using the Training Interface to Access Transceiver Registers via the DRP Port

Miscellaneous Signals - Virtex-7/Kintex-7 FPGAs

Table 2-15: Miscellaneous Signals

Signal Name	Direction	Description
core_status[7:0]	OUT	Bit 0 = PCS Block Lock, Bits [7:6] are reserved BASE-KR cores: FEC Signal OK in bit 1, pmd_signal_detect (Training Done) in bit 2, AN Complete in bit 3, AN Enable is bit 4 and an_link_up is bit 5. ^a
is_eval	OUT	Base-KR only: Constant output which is '1' if this is an Evaluation Licensed core
an_enable	IN	Base-KR only: Used to disable Autonegotiation during simulation - normally tie this to '1'. Only for cores with Optional Autonegotiation block
tx_prbs31_en	OUT	Used to enable built-in PRBS31 transmission in the transceiver
rx_prbs31_en	OUT	Used to enable built-in PRBS31 checking in the transceiver
clear_rx_prbs_err_count	OUT	Signal to transceiver to clear the RX PRBS31 error counter.
loopback_ctrl [2:0]	OUT	Loopback control from core to transceiver

a. The latter two signals are required in the block level of the core to enable a switching of transceiver RX modes during AutoNegotiation.

Register Space

10GBASE-R PCS/PMA Register Map

If the core is configured as a 10GBASE-R PCS/PMA, it occupies MDIO Device Addresses 1 and 3 in the MDIO register address map, as shown in [Table 2-16](#).

Table 2-16: 10GBASE-R/KR PCS/PMA MDIO Registers

Register Address	Register Name
1.0	PMA/PMD Control 1
1.1	PMA/PMD Status 1
1.4	PMA/PMD Speed Ability
1.5, 1.6	PMA/PMD Devices in Package
1.7	10G PMA/PMD Control 2
1.8	10G PMA/PMD Status 2
1.9	10G PMD Transmit Disable
1.10	10G PMD Receive Signal OK
1.11 to 1.32787	Reserved
1.32788	PMA Vendor Specific Loopback (Virtex-6 FPGAs only)
1.32789 to 1.65534	Reserved
1.65535	Core Version Info
3.0	PCS Control 1
3.1	PCS Status 1
3.4	PCS Speed Ability
3.5, 3.6	PCS Devices in Package
3.7	10G PCS Control 2
3.8	10G PCS Status 2
3.9 to 3.31	Reserved
3.32	10GBASE-R/KR PCS Status 1
3.33	10GBASE-R/KR PCS Status 2
3.34-37	10GBASE-R/KR Test Pattern Seed A
3.38-41	10GBASE-R/KR Test Pattern Seed B
3.42	10GBASE-R/KR Test Pattern Control
3.43	10GBASE-R/KR Test Pattern Error Counter
3.44 to 3.65534	Reserved

Table 2-16: 10GBASE-R/KR PCS/PMA MDIO Registers (Cont'd)

Register Address	Register Name
3.32769 to 3.65534	Reserved
3.65535	PCS 125 μ s timer control

10GBASE-KR PCS/PMA Register Map

If the core is configured as a 10GBASE-KR PCS/PMA, it occupies MDIO Device Addresses 1, 3 and optionally 7 in the MDIO register address map, as shown in [Table 2-17](#).

Table 2-17: 10GBASE-KR PCS/PMA Registers

Register Address	Register Name
1.0	PMA/PMD Control 1
1.1	PMA/PMD Status 1
1.150	10GBASE-KR PMD control
1.151	10GBASE-KR PMD status
1.152	10GBASE-KR LP coefficient update
1.153	10GBASE-KR LP status report
1.154	10GBASE-KR LD coefficient update
1.155	10GBASE-KR LD status report
1.170	10GBASE-R FEC ability ⁽¹⁾
1.171	10GBASE-R FEC control ⁽¹⁾
1.172 to 1.173	10GBASE-R FEC corrected blocks counter ⁽¹⁾
1.174 to 1.175	10GBASE-R FEC uncorrected blocks counter ⁽¹⁾
1.4	PMA/PMD Speed Ability
1.5, 1.6	PMA/PMD Devices in Package
1.7	10G PMA/PMD Control 2
1.8	10G PMA/PMD Status 2
1.9	10G PMD Transmit Disable
1.10	10G PMD Receive Signal OK
1.11 to 1.149	Reserved
1.176 to 1.65519	Reserved
1.65520	LD Training (vendor-specific register where Local Device Coefficient Updates are to be written by Training Algorithm)
1.65521 to 1.65534	Reserved
1.65535	Core Version Info (Virtex-7/Kintex™-7 FPGAs only)
3.0	PCS Control 1
3.1	PCS Status 1

Table 2-17: 10GBASE-KR PCS/PMA Registers (Cont'd)

Register Address	Register Name
3.4	PCS Speed Ability (Virtex-7/Kintex-7 FPGAs only)
3.5, 3.6	PCS Devices in Package
3.7	10G PCS Control 2
3.8	10G PCS Status 2
3.9 to 3.31	Reserved
3.32	10GBASE-R/KR PCS Status 1
3.33	10GBASE-R/KR PCS Status 2
3.34-37	10GBASE-R/KR Test Pattern Seed A
3.38-41	10GBASE-R/KR Test Pattern Seed B
3.42	10GBASE-R/KR Test Pattern Control
3.43	10GBASE-R/KR Test Pattern Error Counter
3.44 to 3.32767	Reserved
3.32768	PCS Vendor Specific Loopback (Virtex-6 FPGAs only)
3.65535	PCS 125 μ s timer control (Virtex-7/Kintex-7 FPGAs only)
7.0	AN Control ⁽²⁾
7.1	AN Status ⁽²⁾
7.16, 17, 18	AN Advertisement ⁽²⁾
7.19, 20, 21	AN LP Base Page Ability ⁽²⁾
7.22, 23, 24	AN XNP transmit ⁽²⁾
7.25, 26, 27	AN LP XNP ability ⁽²⁾
7.48	Backplane Ethernet Status ⁽²⁾

1. For cores with optional FEC block
2. For cores with optional AN block

MDIO Register 1.0: PMA/PMD Control 1

Figure 2-5 shows the MDIO Register 1.0: Physical Medium Attachment/Physical Medium Dependent (PMA/PMD) Control 1.

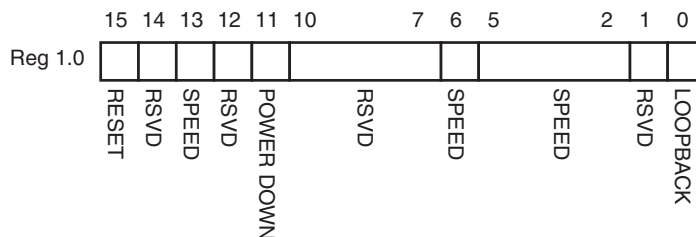

Figure 2-5: PMA/PMD Control 1 Register

Table 2-18 shows the PMA Control 1 register bit definitions.

Table 2-18: PMA/PMD Control 1 Register Bit Definitions

Bit(s)	Name	Description	Attributes	Default Value
1.0.15	Reset	1 = Block reset 0 = Normal operation The 10GBASE-R/KR block is reset when this bit is set to '1.' It returns to '0' when the reset is complete.	R/W Self-clearing	0
1.0.14	Reserved	The block always returns '0' for this bit and ignores writes.	R/O	0
1.0.13	Speed Selection	The block always returns '1' for this bit and ignores writes.	R/O	1
1.0.12	Reserved	The block always returns '0' for this bit and ignores writes.	R/O	0
1.0.11	Power down	This bit has no effect.	R/W	0
1.0.10:7	Reserved	The block always returns '0' for these bits and ignores writes.	R/O	All 0s
1.0.6	Speed Selection	The block always returns '1' for this bit and ignores writes.	R/O	1
1.0.5:2	Speed Selection	The block always returns '0s' for these bits and ignores writes.	R/O	All 0s
1.0.1	Reserved	The block always returns '0' for this bit and ignores writes.	R/O	All 0s
1.0.0	Loopback	1 = Enable PMA loopback mode 0 = Disable PMA loopback mode Virtex-6 FPGAs: The 10GBASE-R/KR block will loop the transmit signal inside the GTH transceiver back into the receiver. The vendor-specific register bits 1.32788.1:0 take precedence over this bit.	R/W	0

MDIO Register 1.1: PMA/PMD Status 1

Figure 2-6 shows the MDIO Register 1.1: PMA/PMD Status 1.

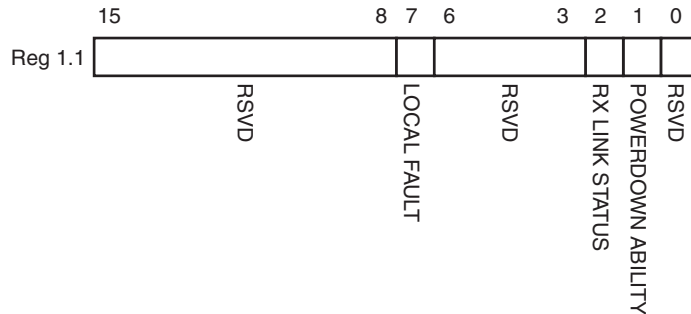

Figure 2-6: PMA/PMD Status 1 Register

Table 2-19 shows the PMA/PMD Status 1 register bit definitions.

Table 2-19: PMA/PMD Status 1 Register Bit Definitions

Bit(s)	Name	Description	Attributes	Default Value
1.1.15:8	Reserved	The block always returns '0' for this bit.	R/O	0
1.1.7	Local Fault	Virtex-6: The block always returns '0' for this bit. Virtex-7/Kintex-7: 1 = Local Fault detected	R/O	0
1.1.6:3	Reserved	The block always returns '0' for this bit.	R/O	0
1.1.2	Receive Link Status	Virtex-6: The block always returns '1' for this bit Virtex-7/Kintex-7: 1 = Receive Link UP	R/O V7/K7: Latches Low	1
1.1.1	Power Down Ability	The block always returns '1' for this bit.	R/O	1
1.1.0	Reserved	The block always returns '0' for this bit.	R/O	0

MDIO Register 1.4: PMA/PMD Speed Ability

Figure 2-7 shows the MDIO Register 1.4: PMA/PMD Speed Ability.

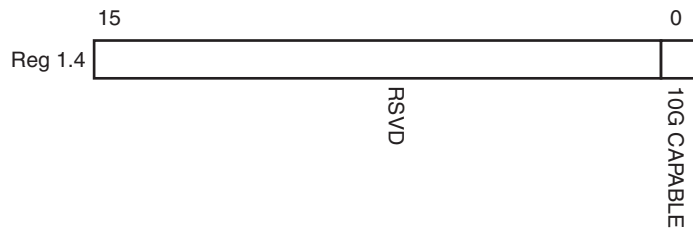

Figure 2-7: PMA/PMD Speed Ability Register

Table 2-20 shows the PMA/PMD Speed Ability register bit definitions.

Table 2-20: PMA/PMD Speed Ability Register Bit Definitions

Bit(s)	Name	Description	Attribute	Default Value
1.4.15:1	Reserved	The block always returns '0' for these bits and ignores writes.	R/O	All 0s
1.4.0	10G Capable	The block always returns '1' for this bit and ignores writes.	R/O	1

MDIO Registers 1.5 and 1.6: PMA/PMD Devices in Package

Figure 2-8 shows the MDIO Registers 1.5 and 1.6: PMA/PMD Devices in Package.

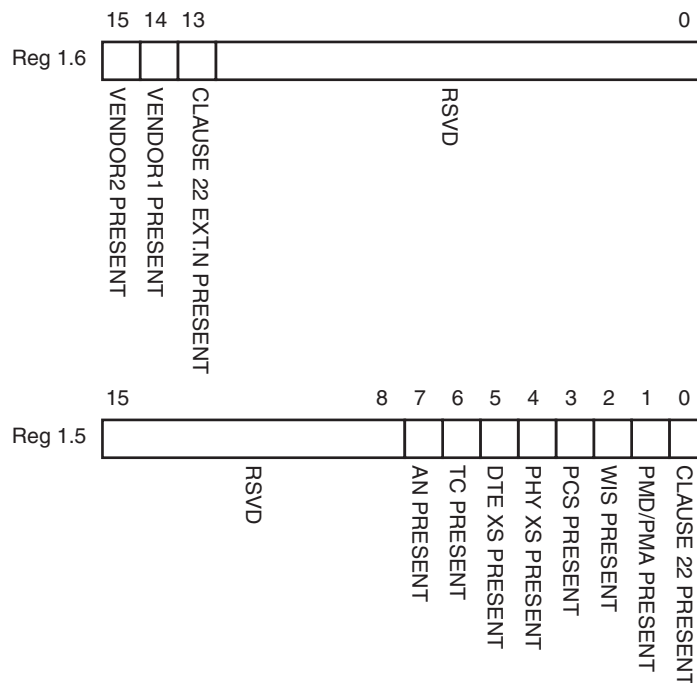

Figure 2-8: PMA/PMD Devices in Package Registers

Table 2-21 shows the PMA/PMD Device in Package registers bit definitions.

Table 2-21: PMA/PMD Devices in Package Registers Bit Definitions

Bit(s)	Name	Description	Attributes	Default Value
1.6.15	Vendor- specific Device 2 Present	The block always returns '0' for this bit.	R/O	0
1.6.14	Vendor-specific Device 1 Present	The block always returns '0' for this bit.	R/O	0
1.6.13	Clause 22 Extension Present	The block always returns '1' for this bit.	R/O	1
1.6.12:0	Reserved	The block always returns '0' for these bits.	R/O	All 0s
1.5.15:8	Reserved	The block always returns '0' for these bits.	R/O	All 0s
1.5.7	Autonegotiation present	Virtex-6: The block always returns '1' for this bit. Virtex-7/Kintex-7: 1 = optional AN block is included	R/O	1
1.5.6	TC Present	The block always returns '0' for this bit	R/O	0

Table 2-21: PMA/PMD Devices in Package Registers Bit Definitions (Cont'd)

Bit(s)	Name	Description	Attributes	Default Value
1.5.5	DTE XS Present	The block always returns '0' for this bit.	R/O	0
1.5.4	PHY XS Present	The block always returns '0' for this bit.	R/O	0
1.5.3	PCS Present	The block always returns '1' for this bit.	R/O	1
1.5.2	WIS Present	The block always returns '0' for this bit.	R/O	0
1.5.1	PMA/PMD Present	The block always returns '1' for this bit.	R/O	1
1.5.0	Clause 22 Device Present	The block always returns '0' for this bit.	R/O	0

MDIO Register 1.7: 10G PMA/PMD Control 2

Figure 2-9 shows the MDIO Register 1.7: 10G PMA/PMD Control 2.

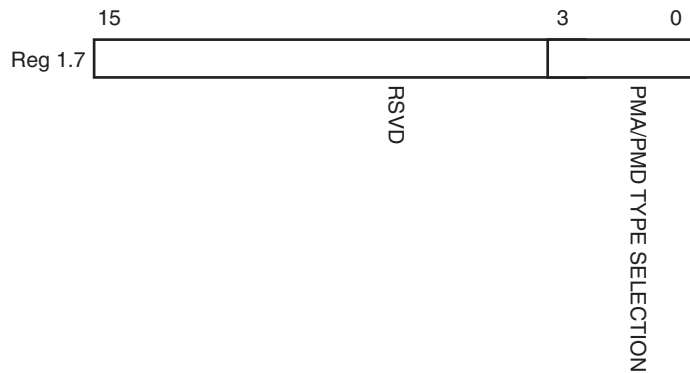

Figure 2-9: 10G PMA/PMD Control 2 Register

Table 2-22 shows the PMA/PMD Control 2 register bit definitions.

Table 2-22: 10G PMA/PMD Control 2 Register Bit Definitions

Bit(s)	Name	Description	Attributes	Default Value
1.7.15:4	Reserved	The block always returns '0' for these bits and ignores writes.	R/O	All 0s
1.7.3:0	PMA/PMD Type Selection	Virtex-7/Kintex-7 FPGAs: This returns the value '0xyz', where 'xyz' is set from the top level core port pma_pmd_type vector. Virtex-6 FPGAs: The block returns a code for the 10GBASE-*R PMA/PMD and ignores written values which do not correspond to the PCS_ABILITY register settings (1.8.7:1). '0111' denotes 10GBASE-SR, '0110' denotes -LR and '0101' denotes -ER.	R/W	Virtex-7/Kintex-7 FPGAs: Base-R: Set from pma_pmd_type port. BASE-KR: returns 0xB Virtex-6 FPGAs: Set from GTH transceiver attribute.

MDIO Register 1.8: 10G PMA/PMD Status 2

Figure 2-10 shows the MDIO Register 1.8: 10G PMA/PMD Status 2.

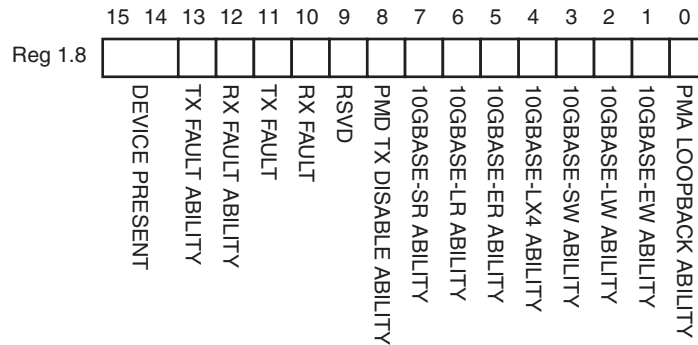

Figure 2-10: 10G PMA/PMD Status 2 Register

Table 2-23 shows the PMA/PMD Status 2 register bit definitions.

Table 2-23: 10G PMA/PMD Status 2 Register Bit Definitions

Bit(s)	Name	Description	Attributes	Default Value
1.8.15:14	Device Present	The block always returns '10' for these bits.	R/O	'10'
1.8.13	Transmit Local Fault Ability	Virtex-6: The block always returns '0' for this bit. Virtex-7/Kintex-7: The block always returns a '1' for this bit.	R/O	Virtex-6: 0 Virtex-7/Kintex-7: 1
1.8.12	Receive Local Fault Ability	Virtex-6: The block always returns '0' for this bit Virtex-7/Kintex-7: The block always returns a '1' for this bit.	R/O	Virtex-6: 0 Virtex-7/Kintex-7: 1
1.8.11	Transmit Fault	Virtex-6: The block always returns '0' for this bit. Virtex-7/Kintex-7: 1 = Transmit Fault detected	R/O V7/K7: Latches High	0
1.8.10	Receive Fault	Virtex-6: The block always returns '0' for this bit. Virtex-7/Kintex-7: 1 = Receive Fault detected	R/O V7/K7: Latches High	0
1.8.9	Extended abilities	The block always returns '1' for this bit.	R/O	1
1.8.8	PMD Transmit Disable Ability	The block always returns '1' for this bit.	R/O	1
1.8.7	10GBASE-SR Ability	Virtex-7/Kintex-7 FPGAs: Base-R only: Returns a '1' if pma_pmd_type port is set to '111' Virtex-6 FPGAs: The block always returns '1' for this bit.	R/O	Virtex-7/Kintex-7: Depends on pma_pmd_type port Virtex-6 FPGAs: 1

Table 2-23: 10G PMA/PMD Status 2 Register Bit Definitions (Cont'd)

Bit(s)	Name	Description	Attributes	Default Value
1.8.6	10GBASE-LR Ability	Virtex-7/Kintex-7 FPGAs: Base-R only: Returns a '1' if pma_pld_type port is set to '110' Virtex-6 FPGAs: The block always returns '1' for this bit.	R/O	Virtex-7/Kintex-7: Returns a '1' if pma_pld_type port is set to '110' Virtex-6 FPGAs: 1
1.8.5	10GBASE-ER Ability	Virtex-7/Kintex-7 FPGAs: Base-R only: Returns a '1' if the pma_pmd_type port is set to '101' Virtex-6 FPGAs: The block always returns '1' for this bit.	R/O	Virtex-7/Kintex-7: Depends on pma_pmd_type port Virtex-6 FPGAs: 1
1.8.4	10GBASE-LX4 Ability	The block always returns '0' for this bit.	R/O	0
1.8.3	10GBASE-SW Ability	The block always returns '0' for this bit.	R/O	0
1.8.2	10GBASE-LW Ability	The block always returns '0' for this bit.	R/O	0
1.8.1	10GBASE-EW Ability	The block always returns '0' for this bit.	R/O	0
1.8.0	PMA Loopback Ability	The block always returns '1' for this bit.	R/O	1

MDIO Register 1.9: 10G PMD Transmit Disable

Figure 2-11 shows the MDIO 1.9 Register: 10G PMD Transmit Disable.

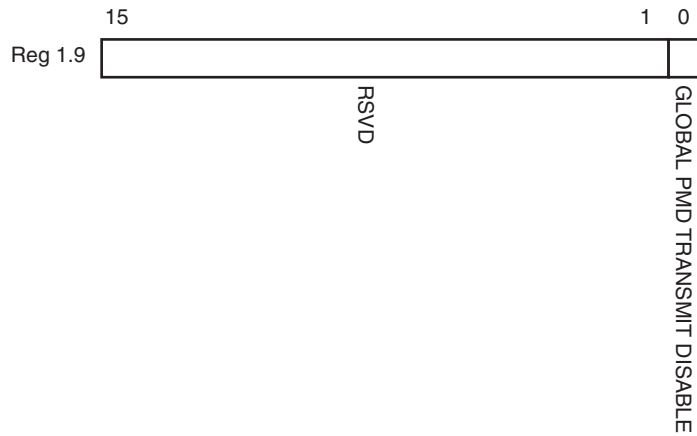

Figure 2-11: 10G PMD Transmit Disable Register

Table 2-24: 10G PMD Transmit Disable Register Bit Definitions

Bit(s)	Name	Description	Attributes	Default Value
1.9.15:1	Reserved	The block always returns '0' for these bits and ignores writes.	R/O	All 0s
1.9.0	Global PMD Transmit Disable	1 = Disable Transmit path (also sets transmit_disable pin) 0 = Enable Transmit path	Virtex-6: R/W V7/K7: R/W	Virtex-6: Set from GTH attribute. V7/K7: 0

MDIO Register 1.10: 10G PMD Signal Receive OK

Figure 2-12 shows the MDIO 1.10 Register: 10G PMD Signal Receive OK.

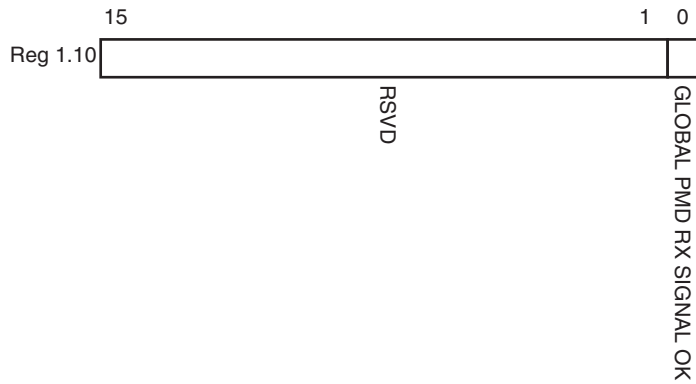

Figure 2-12: 10G PMD Signal Receive OK Register

Table 2-23 shows the PMD Signal Receive OK register bit definitions.

Table 2-25: 10G PMD Signal Receive OK Register Bit Definitions

Bit(s)	Name	Description	Attributes	Default Value
1.10.15:1	Reserved	The block always returns '0' for these bits.	R/O	0s
1.10.0	Global PMD receive signal detect	1 = Signal detected on receive 0 = Signal not detected on receive	R/O	n/a

MDIO Register 1.150: 10GBASE-KR PMD Control

Figure 2-13 shows the MDIO Register 1.150: 10GBASE-KR PMD Control.

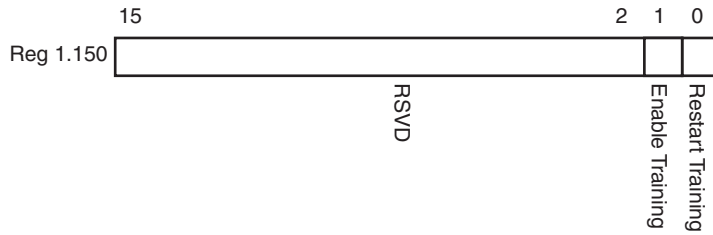

Figure 2-13: 10GBASE-KR PMD Control Register

Table 2-26 shows the 10GBASE-KR PMD Control register bit definitions.

Table 2-26: 10GBASE-KR PMD Control Register Bit Definitions

Bit(s)	Name	Description	Attributes	Default Value
1.150.15:2	Reserved	The block always returns '0' for this bit and ignores writes.	R/O	0
1.150.1	Training enable	1 = Enable the 10GBASE-KR start-up protocol 0 = Disable	R/W	0
1.150.0	Restart Training	1 = Reset the 10GBASE-KR start-up protocol 0 = Normal operation	R/W Self-clearing	0

MDIO Register 1.151: 10GBASE-KR PMD Status

Figure 2-14 shows the MDIO Register 1.151: 10GBASE-KR PMD Status.

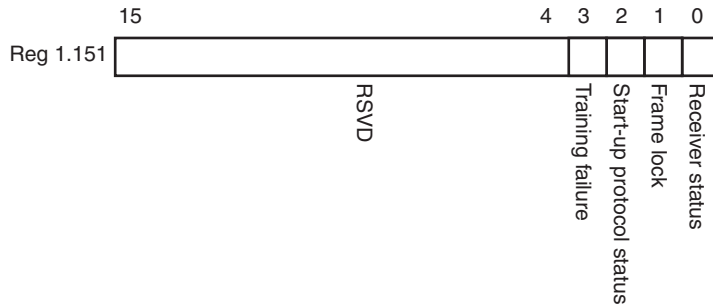

Figure 2-14: 10GBASE-KR PMD Status Register

Table 2-27 shows the 10GBASE-KR PMD Status register bit definitions.

Table 2-27: 10GBASE-KR PMD Status Register Bit Definitions

Bit(s)	Name	Description	Attributes	Default Value
1.151.15:4	Reserved	The block always returns '0' for this bit and ignores writes.	R/O	0
1.151.3	Training Failure	1 = Training Failure has been detected 0 = Not detected	R/O	0
1.151.2	Start-up Protocol status	1 = Start-up protocol in progress 0 = Protocol complete	R/O	0
1.151.1	Frame Lock	1 = Training frame delineation detected 0 = Not detected	R/O	0
1.151.0	Receiver status	1 = Receiver trained and ready to receive data 0 = Receiver training	R/O	0

MDIO Register 1.152: 10GBASE-KR LP Coefficient Update

Figure 2-15 shows the MDIO Register 1.152: 10GBASE-KR LP Coefficient Update.

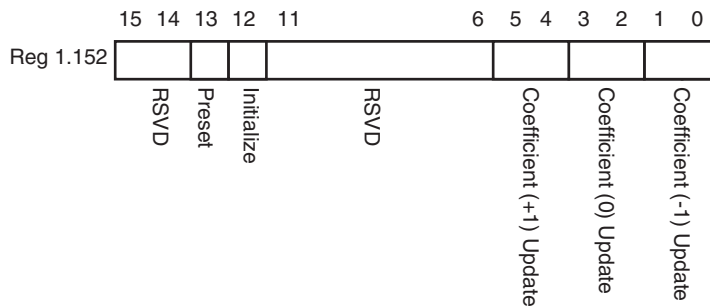

Figure 2-15: 10GBASE-KR LP Coefficient Update Register

Table 2-28 shows the 10GBASE-KR LP coefficient update register bit definitions.

Table 2-28: 10GBASE-KR LP Coefficient Update Register Bit Definitions

Bit(s)	Name	Description	Attributes	Default Value
1.152.15:14	Reserved	The block always returns '0' for this bit and ignores writes.	R/O	0
1.152.13	Preset	1 = Preset coefficients 0 = Normal operation	R/W ^a	0
1.152.12	Initialize	1 = Initialize coefficients 0 = Normal operation	R/W ^a	0
1.152.11:6	Reserved	The block always returns '0' for this bit and ignores writes.	R/O	0's
1.152.5:4	Coefficient (+1) update	5:4 = 11 = reserved 10 = decrement 01 = increment 00 = hold	R/W ^a	00
1.152.3:2	Coefficient (0) update	3:2 = 11 = reserved 10 = decrement 01 = increment 00 = hold	R/W ^a	00
1.152.1:0	Coefficient (-1) update	1:0 = 11 = reserved 10 = decrement 01 = increment 00 = hold	R/W ^a	00

a. Writable only when register 1.150.1 = 0

MDIO Register 1.153: 10GBASE-KR LP Status

Figure 2-16 shows the MDIO Register 1.153: 10GBASE-KR LP status.

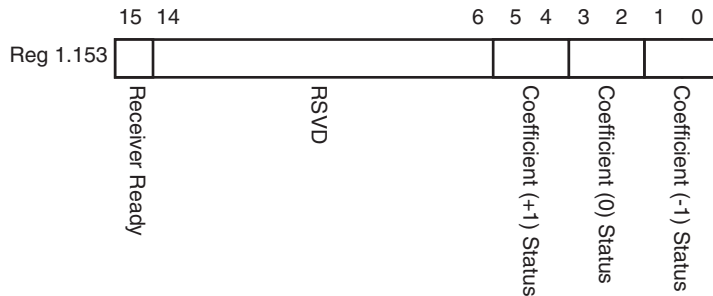

Figure 2-16: 10GBASE-KR LP Status Register

Table 2-29 shows the 10GBASE-KR LP status register bit definitions.

Table 2-29: 10GBASE-KR LP Status Register Bit Definitions

Bit(s)	Name	Description	Attributes	Default Value
1.153.15:14	Receiver Ready	1 = The LP receiver has determined that training is complete and is prepared to receive data 0 = The LP receiver is requesting that training continue	R/O	0
1.153.14:6	Reserved	The block always returns '0' for this bit and ignores writes.	R/O	0's
1.153.5:4	Coefficient (+1) status	5:4 = 11 = maximum 10 = minimum 01 = updated 00 = not updated	R/O	00
1.153.3:2	Coefficient (0) status	3:2 = 11 = maximum 10 = minimum 01 = updated 00 = not updated	R/O	00
1.153.1:0	Coefficient (-1) status	1:0 = 11 = maximum 10 = minimum 01 = updated 00 = not updated	R/O	00

MDIO Register 1.154: 10GBASE-KR LD Coefficient Update

Figure 2-17 shows the MDIO Register 1.154: 10GBASE-KR LD coefficient update.

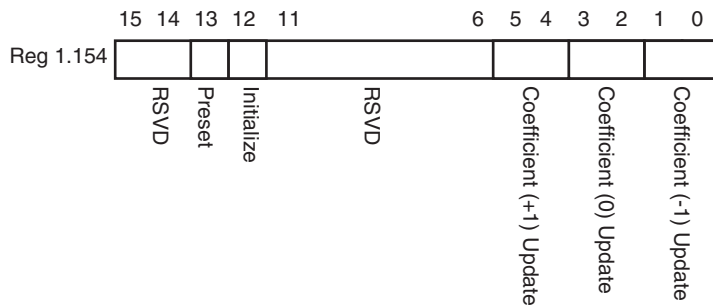

Figure 2-17: 10GBASE-KR LD Coefficient Update Register

Table 2-30 shows the 10GBASE-KR LD coefficient update register bit definitions.

Table 2-30: 10GBASE-KR LD Coefficient Update Register Bit Definitions

Bit(s)	Name	Description	Attributes	Default Value
1.154.15:14	Reserved	The block always returns '0' for this bit and ignores writes.	R/O	0
1.154.13	Preset	1 = Preset coefficients 0 = Normal operation	R/O ^a	0
1.154.12	Initialize	1 = Initialize coefficients 0 = Normal operation	R/O ^a	0
1.154.11:6	Reserved	The block always returns '0' for this bit and ignores writes.	R/O	0's
1.154.5:4	Coefficient (+1) update	5:4 = 11 = reserved 10 = decrement 01 = increment 00 = hold	R/O ^a	00
1.154.3:2	Coefficient (0) update	3:2 = 11 = reserved 10 = decrement 01 = increment 00 = hold	R/O ^a	00
1.154.1:0	Coefficient (-1) update	1:0 = 11 = reserved 10 = decrement 01 = increment 00 = hold	R/O ^a	00

a. These registers are programmed by writing to register 1.65520

MDIO Register 1.155: 10GBASE-KR LD Status

Figure 2-18 shows the MDIO Register 1.155: 10GBASE-KR LD status.

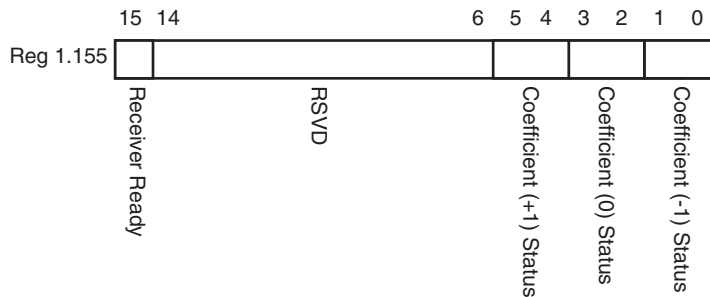

Figure 2-18: 10GBASE-KR LD Status Register

Table 2-31 shows the 10GBASE-KR LD status register bit definitions.

Table 2-31: 10GBASE-KR LD Status Register Bit Definitions

Bit(s)	Name	Description	Attributes	Default Value
1.155.15	Receiver Ready	1 = The LD receiver has determined that training is complete and is prepared to receive data 0 = The LD receiver is requesting that training continue	R/O	0
1.155.14:6	Reserved	The block always returns '0' for this bit and ignores writes.	R/O	0's
1.155.5:4	Coefficient (+1) status	5:4 = 11 = maximum 10 = minimum 01 = updated 00 = not updated	R/O	00
1.155.3:2	Coefficient (0) status	3:2 = 11 = maximum 10 = minimum 01 = updated 00 = not updated	R/O	00
1.155.1:0	Coefficient (-1) status	1:0 = 11 = maximum 10 = minimum 01 = updated 00 = not updated	R/O	00

MDIO Register 1.170: 10GBASE-R FEC Ability

Figure 2-19 shows the MDIO Register 1.170: 10GBASE-R FEC Ability.

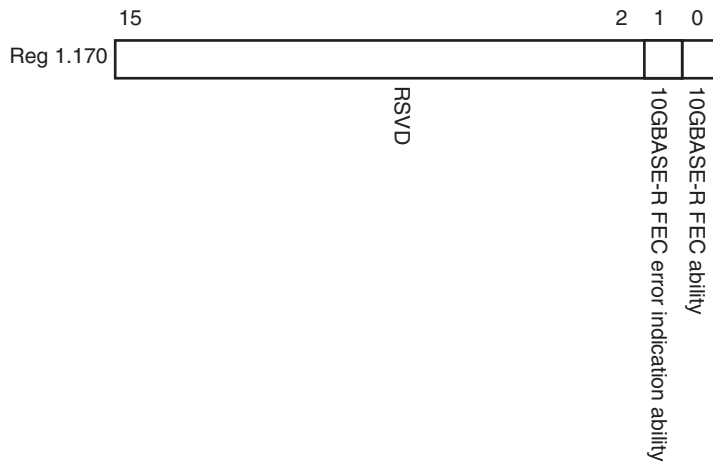

Figure 2-19: 10GBASE-R FEC Ability Register

Table 2-32 shows the 10GBASE-R FEC Ability register bit definitions.

Table 2-32: 10GBASE-R FEC Ability Register Bit Definitions

Bit(s)	Name	Description	Attributes	Default Value
1.170.15:2	Reserved	The block always returns '0' for this bit and ignores writes.	R/O	0's
1.170.1	10GBASE-R FEC error indication ability	1 = the PHY is able to report FEC decoding errors to the PCS layer	R/O	1
1.170.0	10GBASE-R FEC ability	1 = the PHY supports FEC	R/O	1

MDIO Register 1.171: 10GBASE-R FEC Control

Figure 2-20 shows the MDIO Register 1.170: 10GBASE-R FEC Control.

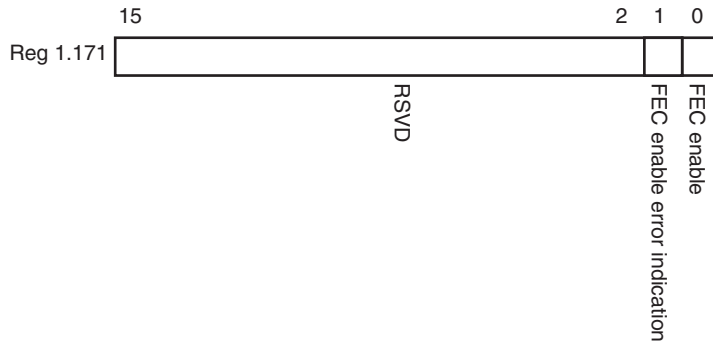

Figure 2-20: 10GBASE-R FEC Control Register

Table 2-33 shows the 10GBASE-R FEC Control register bit definitions.

Table 2-33: 10GBASE-R FEC Control Register Bit Definitions

Bit(s)	Name	Description	Attributes	Default Value
1.171.15:2	Reserved	The block always returns '0' for this bit and ignores writes.	R/O	0's
1.171.1	10GBASE-R FEC error indication ability	1 = Configure the PHY to report FEC decoding errors to the PCS layer	R/W	0
1.171.0	10GBASE-R FEC ability	1 = enable FEC 0 = disable FEC	R/W	0

MDIO Register 1.172: 10GBASE-R FEC Corrected Blocks (Lower)

Figure 2-21 shows the MDIO Register 1.172: 10GBASE-R FEC Corrected Blocks (lower).

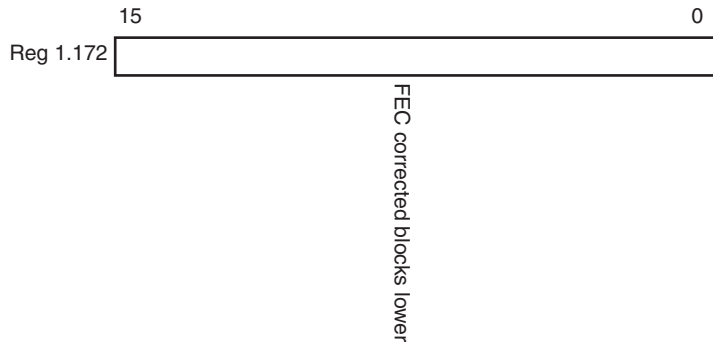

Figure 2-21: 10GBASE-R FEC Corrected Blocks (Lower) Register

Table 2-34 shows the 10GBASE-R FEC Corrected Blocks (lower) register bit definitions.

Table 2-34: 10GBASE-R FEC Corrected Blocks (Lower) Register Bit Definitions

Bit(s)	Name	Description	Attributes	Default Value
1.172.15:0	FEC corrected blocks	Bits 15:0 of the Corrected Blocks count	R/O	0's

MDIO Register 1.173: 10GBASE-R FEC Corrected Blocks (Upper)

Figure 2-22 shows the MDIO Register 1.173: 10GBASE-R FEC Corrected Blocks (upper).

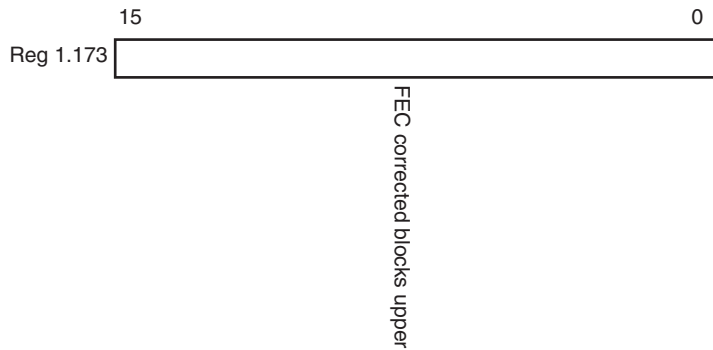

Figure 2-22: 10GBASE-R FEC Corrected Blocks (Upper) Register

Table 2-35 shows the 10GBASE-R FEC Corrected Blocks (upper) register bit definitions.

Table 2-35: 10GBASE-R FEC Corrected Blocks (Upper) Register Bit Definitions

Bit(s)	Name	Description	Attributes	Default Value
1.172.15:0	FEC corrected blocks	Bits 31:16 of the Corrected Blocks count	R/O	0's

MDIO Register 1.174: 10GBASE-R FEC Uncorrected Blocks (Lower)

Figure 2-23 shows the MDIO Register 1.174: 10GBASE-R FEC Uncorrected Blocks (lower).

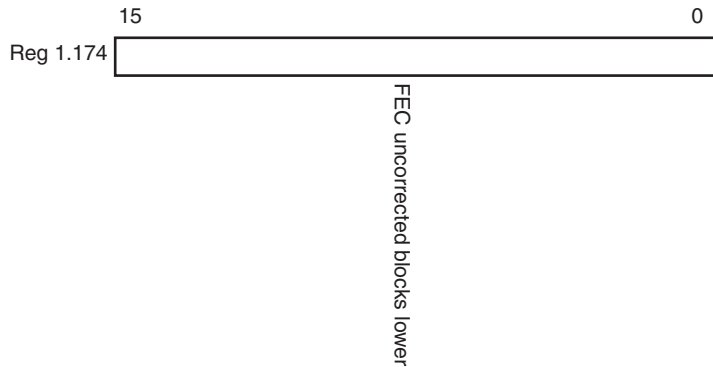

Figure 2-23: 10GBASE-R FEC Uncorrected Blocks (Lower) Register

Table 2-36 shows the 10GBASE-R FEC Uncorrected Blocks (lower) register bit definitions.

Table 2-36: 10GBASE-R FEC Uncorrected Blocks (Lower) Register Bit Definitions

Bit(s)	Name	Description	Attributes	Default Value
1.174.15:0	FEC Uncorrected blocks	Bits 15:0 of the Uncorrected Blocks count	R/O	0's

MDIO Register 1.175: 10GBASE-R FEC Uncorrected Blocks (Upper)

Figure 2-24 shows the MDIO Register 1.175: 10GBASE-R FEC Uncorrected Blocks (upper).

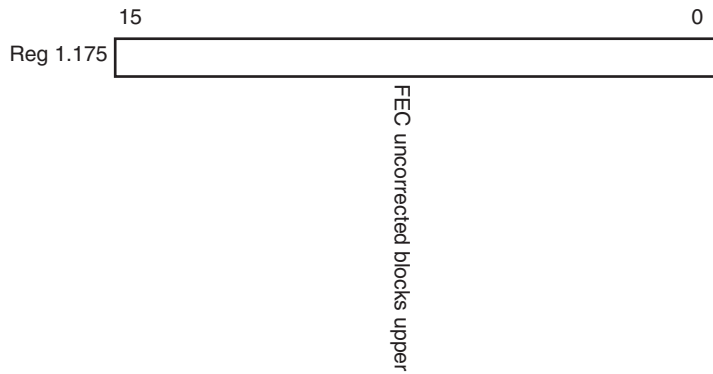

Figure 2-24: 10GBASE-R FEC Uncorrected Blocks (Upper) Register

Table 2-37 shows the 10GBASE-R FEC Uncorrected Blocks (upper) register bit definitions.

Table 2-37: 10GBASE-R FEC Uncorrected Blocks (Upper) Register Bit Definitions

Bit(s)	Name	Description	Attributes	Default Value
1.175.15:0	FEC Uncorrected blocks	Bits 31:16 of the Uncorrected Blocks count	R/O	0's

MDIO Register 1.32788: Vendor-Specific PMA Loopback Control (Virtex-6 FPGAs Only)

Figure 2-25 shows the MDIO 1.32788 Register: Vendor-Specific PMA Loopback Control.

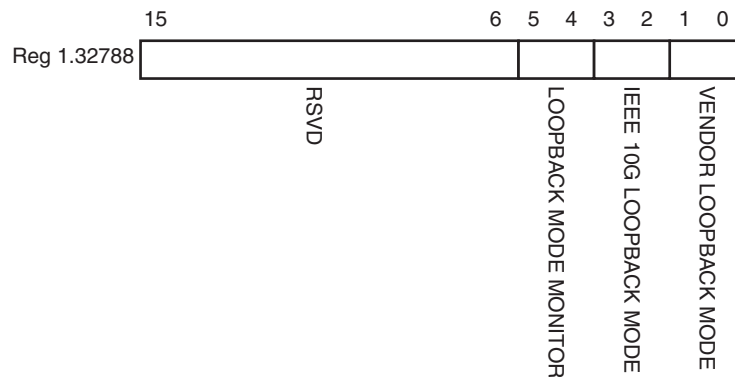

Figure 2-25: Vendor-Specific PMA Loopback Control Register

Table 2-38: Vendor-Specific PMA Loopback Control

Bit(s)	Name	Description	Attributes	Default Value
1.32788.15:6	Reserved	The block always returns '0' for these bits and writes are ignored	R/O	All '0'
1.32788.5:4	Loopback Mode Monitor	Bits reflect the current state of loopback control. If 1.32788.1:0 is set to '00' and register 1.0.0 is set to '1', then these bits are equal to 1.32788.3:2, otherwise these bits are equal to 1.32788.1:0. Consult the <i>Virtex-6 FPGA GTH Transceivers User Guide</i> for details.	R/O	'00'

Table 2-38: Vendor-Specific PMA Loopback Control (Cont'd)

Bit(s)	Name	Description	Attributes	Default Value
1.32788.3:2	IEEE 10G Loopback Mode	Configure the course of loopback to RX. These values are applicable only when 1.0.0 is asserted and the vendor config lane loopback mode is disabled. Encodings: '00': IEEE PMA loopback disabled '01': TX output '10': TX predriver '11': Reserved	R/W	'01'
1.32788.1:0	Vendor Specific Loopback Mode	Configure source of on-chip loopback connection to RX. Encodings: '00': Vendor loopback disabled '01': TX output '10': TX predriver '11': Reserved	R/W	'00'

MDIO Register: 1.65520: Vendor-Specific LD Training

Figure 2-26 shows the MDIO Register 1.65520: Vendor-specific LD Training.

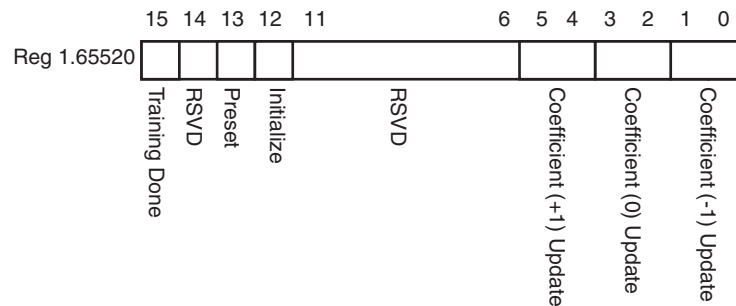

Figure 2-26: Vendor-specific LD Training Register

Table 2-39 shows the Vendor-specific LD Training register bit definitions.

Table 2-39: Vendor-Specific LD Training Register Bit Definitions

Bit(s)	Name	Description	Attributes	Default Value
1.65520.15	Training Done	1 = Training Algorithm has determined that the LP transmitter has been successfully trained.	R/W ^a	0
1.65520.14	Reserved	The block always returns '0' for this bit and ignores writes.	R/O	0
1.65520.13	Preset	1 = Preset coefficients 0 = Normal operation	R/O ^b	0
1.65520.12	Initialize	1 = Initialize coefficients 0 = Normal operation	R/O ^b	0
1.65520.5:4	Coefficient (+1) update	5:4 = 11 = reserved 10 = decrement 01 = increment 00 = hold	R/O ^b	00
1.65520.3:2	Coefficient (0) update	3:2 = 11 = reserved 10 = decrement 01 = increment 00 = hold	R/O ^b	00
1.65520.1:0	Coefficient (-1) update	1:0 = 11 = reserved 10 = decrement 01 = increment 00 = hold	R/O ^b	00

a. This register will be transferred automatically to register 1.155.15.

b. These registers will be transferred automatically to register 1.154.

MDIO Register 1.65535: Core Version Info - Virtex-7/Kintex-7 FPGAs Only

Figure 2-27 shows the MDIO 1.65535 Register: Core Version Info

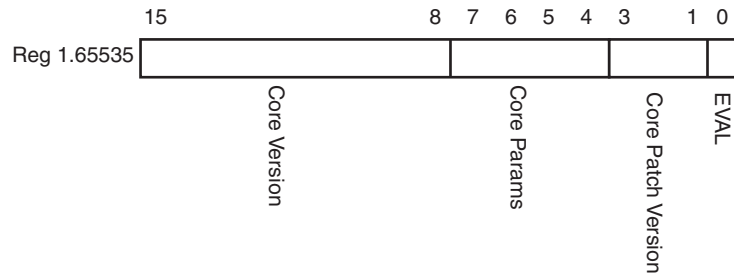

Figure 2-27: Core Version Info Register

Table 2-40: Core Version Information

Bit(s)	Name	Description	Attributes	Default Value
1.65535.15:8	Core Version	Bits 15..12 give the major core version and bits 11..8 give the minor core version	R/O	x'22' for version 2.3 of core
1.65535.7:4	Core parameters	Bit 7 = 1 = KR included Bit 6 - reserved Bit 5 = 1 = AN included Bit 4 = 1 = FEC included	R/O	Depends on core generation parameters
1.65535.3:1	Core Patch Version	Bits 3..1 give the patch number, if any, for the core.	R/O	'000'
1.65535.0	V7/K7 only: EVAL	1 = This core was generated using a Hardware Evaluation license	R/O	'0'

MDIO Register 3.0: PCS Control 1

Figure 2-28 shows the MDIO Register 3.0: PCS Control 1.

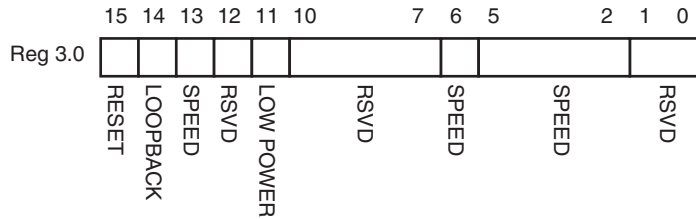

Figure 2-28: PCS Control 1 Register

Table 2-41 shows the PCS Control 1 register bit definitions.

Table 2-41: PCS Control 1 Register Bit Definitions

Bit(s)	Name	Description	Attributes	Default Value
3.0.15	Reset	1 = Block reset 0 = Normal operation The 10GBASE-R/KR block is reset when this bit is set to '1.' It returns to '0' when the reset is complete.	R/W Self-clearing	0
3.0.14	10GBASE-R/KR Loopback	1 = Use PCS Loopback 0 = Do not use PCS Loopback	R/W	0
3.0.13	Speed Selection	The block always returns '1' for this bit. 1 (and bit 6 = 1) = bits 5:2 select the speed	R/O	1
3.0.12	Reserved	The block always returns '0' for this bit and ignores writes.	R/O	0
3.0.11	Power down	This bit has no effect.	R/W	0
3.0.10:7	Reserved	The block always returns '0' for these bits and ignores writes.	R/O	All 0s
3.0.6	Speed Selection	The block always returns '1' for this bit.	R/O	1
3.0.5:2	Speed Selection	The block always returns "0000" = 10Gb/s	R/O	All 0s
3.0.1:0	Reserved	The block always returns '0' for this bit and ignores writes.	R/O	All 0s

MDIO Register 3.1: PCS Status 1

Figure 2-29 shows the MDIO Register 3.1: PCS Status 1.

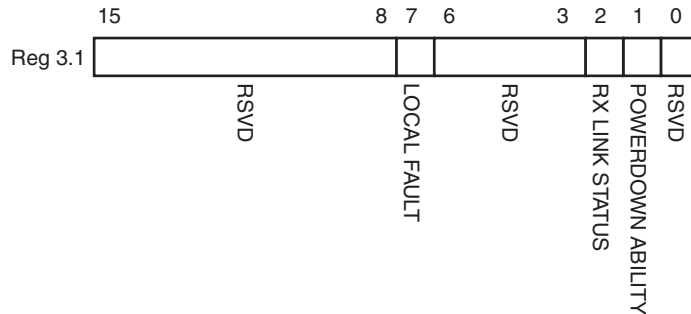

Figure 2-29: PCS Status 1 Register

Table 2-42 show the PCS 1 register bit definitions.

Table 2-42: PCS Status 1 Register Bit Definition

Bit(s)	Name	Description	Attributes	Default Value
3.1.15:8	Reserved	The block always returns '0s' for these bits and ignores writes.	R/O	All 0s
3.1.7	Local Fault	Virtex-6: The block always returns '0' for this bit. V7/K7: 1 = Local Fault detected	R/O	0
3.1.6:3	Reserved	The block always returns '0s' for these bits and ignores writes.	R/O	All 0s
3.1.2	PCS Receive Link Status	1 = The PCS receive link is up 0 = The PCS receive link is down This is a latching Low version of bit 3.32.12.	R/O Self-setting	-
3.1.1	Power Down Ability	The block always returns '1' for this bit.	R/O	1
3.1.0	Reserved	The block always returns '0' for this bit and ignores writes.	R/O	0

MDIO Registers 3.5 and 3.6: PCS Devices in Package

Figure 2-30 shows the MDIO Registers 3.5 and 3.6: PCS Devices in Package.

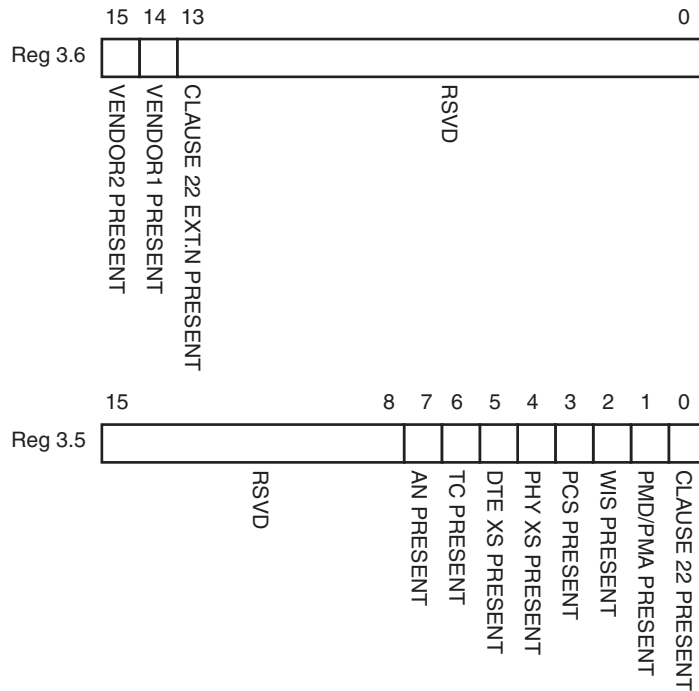

Figure 2-30: PCS Devices in Package Registers

Table 2-43 shows the PCS Devices in Package registers bit definitions.

Table 2-43: PCS Devices in Package Registers Bit Definitions

Bit(s)	Name	Description	Attributes	Default Value
3.6.15	Vendor-specific Device 2 Present	The block always returns '0' for this bit.	R/O	0
3.6.14	Vendor- specific Device 1 Present	The block always returns '0' for this bit.	R/O	0
3.6.13	Clause 22 extension present	Virtex-6:The block always returns '1' for this bit. V7/K7: The block always returns '0' for this bit.	R/O	1
3.6.12:0	Reserved	The block always returns '0' for these bits.	R/O	All 0s
3.5.15:8	Reserved	The block always returns '0' for these bits.	R/O	All 0s
3.5.7	Auto Negotiation Present	Virtex-6: The block always returns '1' for this bit. V7/K7: 1 = AN Block included	R/O	1

Table 2-43: PCS Devices in Package Registers Bit Definitions (Cont'd)

Bit(s)	Name	Description	Attributes	Default Value
3.5.6	TC present	The block always returns '0' for this bit.	R/O	0
3.5.5	PHY XS Present	The block always returns '0' for this bit.	R/O	0
3.5.4	PHY XS Present	The block always returns '0' for this bit.	R/O	0
3.5.3	PCS Present	The block always returns '1' for this bit.	R/O	1
3.5.2	WIS Present	The block always returns '0' for this bit.	R/O	0
3.5.1	PMA/PMD Present	The block always returns '1' for this bit.	R/O	1
3.5.0	Clause 22 device present	The block always returns '0' for this bit.	R/O	0

MDIO Register 3.7: 10G PCS Control 2

Figure 2-31 shows the MDIO Register 3.7: 10G PCS Control 2.

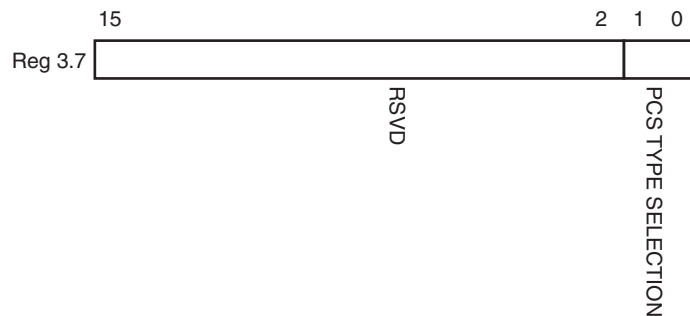

Figure 2-31: 10G PCS Control 2 Register

Table 2-44 shows the 10 G PCS Control 2 register bit definitions.

Table 2-44: 10G PCS Control 2 Register Bit Definitions

Bit(s)	Name	Description	Attributes	Default Value
3.7.15:2	Reserved	The block always returns '0' for these bits and ignores writes.	R/O	All 0s
3.7.1:0	PCS Type Selection	"00" = Select 10GBASE-R PCS type. Any other value written to this register are ignored.	R/W	00

MDIO Register 3.8: 10G PCS Status 2

Figure 2-32 shows the MDIO Register 3.8: 10G PCS Status 2.

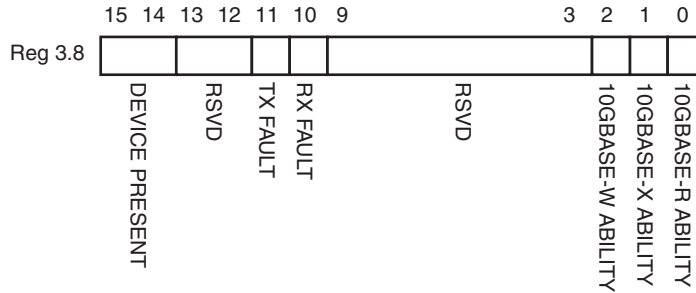

Figure 2-32: 10G PCS Status 2 Register

Table 2-45 shows the 10G PCS Status 2 register bit definitions.

Table 2-45: 10G PCS Status 2 Register Bit Definitions

Bit(s)	Name	Description	Attributes	Default Value
3.8.15:14	Device present	The block always returns "10."	R/O	"10"
3.8.13:12	Reserved	The block always returns '0' for these bits.	R/O	All 0s
3.8.11	Transmit local fault	Virtex-6: The block always returns '0' for this bit. V7/K7: 1 = Transmit Fault detected	R/O	0
3.8.10	Receive local fault	Virtex-6: The block always returns '0' for this bit. V7/K7: 1 = Receive Fault detected	R/O	0
3.8.9:3	Reserved	The block always returns '0' for these bits.	R/O	All 0s
3.8.2	10GBASE-W Capable	The block always returns '0' for this bit.	R/O	0
3.8.1	10GBASE-X Capable	The block always returns '0' for this bit.	R/O	0
3.8.0	10GBASE-R Capable	The block always returns '1' for this bit.	R/O	1

MDIO Register 3.32: 10GBASE-R Status 1

Figure 2-33 shows the MDIO Register 3.32: 10GBASE-R Status 1.

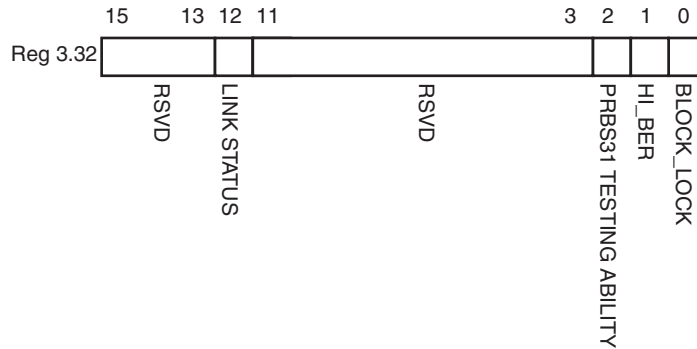

Figure 2-33: 10GBASE-R Status Register 1

Table 2-46 shows the 10GBASE-R Status register bit definitions.

Table 2-46: 10GBASE-R Status Register 1 Bit Definitions

Bit(s)	Name	Description	Attributes	Default Value
3.32.15:13	Reserved	The block always returns '0' for these bits.	R/O	All 0s
3.32.12	10GBASE-R Link Status	1 = 10GBASE-R receive is aligned; 0 = 10GBASE-R receive is not aligned.	RO	0
3.32.11:3	Reserved	The block always returns '0' for these bits.	R/O	0s
3.32.2	PRBS31 Pattern Testing Ability	The block always returns '1' for this bit.	R/O	1
3.32.1	Hi BER	1 = RX showing hi-ber 0 = RX not showing hi ber	R/O	0
3.32.0	Block Lock	1 = RX is synchronized; 0 = RX is not synchronized.	R/O	0

MDIO Register 3.33: 10GBASE-R Status 2

Figure 2-34 shows the MDIO Register 3.33: 10GBASE-R Status 2.

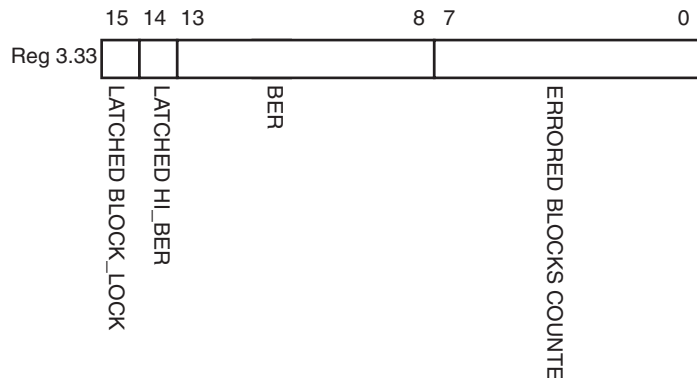

Figure 2-34: 10GBASE-R Status Register 2

Table 2-47 shows the 10GBASE-R Status register bit definition. All bits are cleared when read.

Table 2-47: 10GBASE-R Status Register 2 Bit Definitions

Bit(s)	Name	Description	Attributes	Default Value
3.33.15	Latched Block Lock	Latch-Low version of block lock	R/O	0
3.33.14	Latched HiBER	Latch-High version of Hi BER	R/O	1
3.33.13:8	BER	BER Counter	R/O	0s
3.33.7:0	Errored Blocks Count	Counter for Errored Blocks	R/O	0s

MDIO Register 3.34-37: 10GBASE-R Test Pattern Seed A0-3

Figure 2-35 shows the MDIO Register 3.34-37 10GBASE-R Test Pattern Seed A.

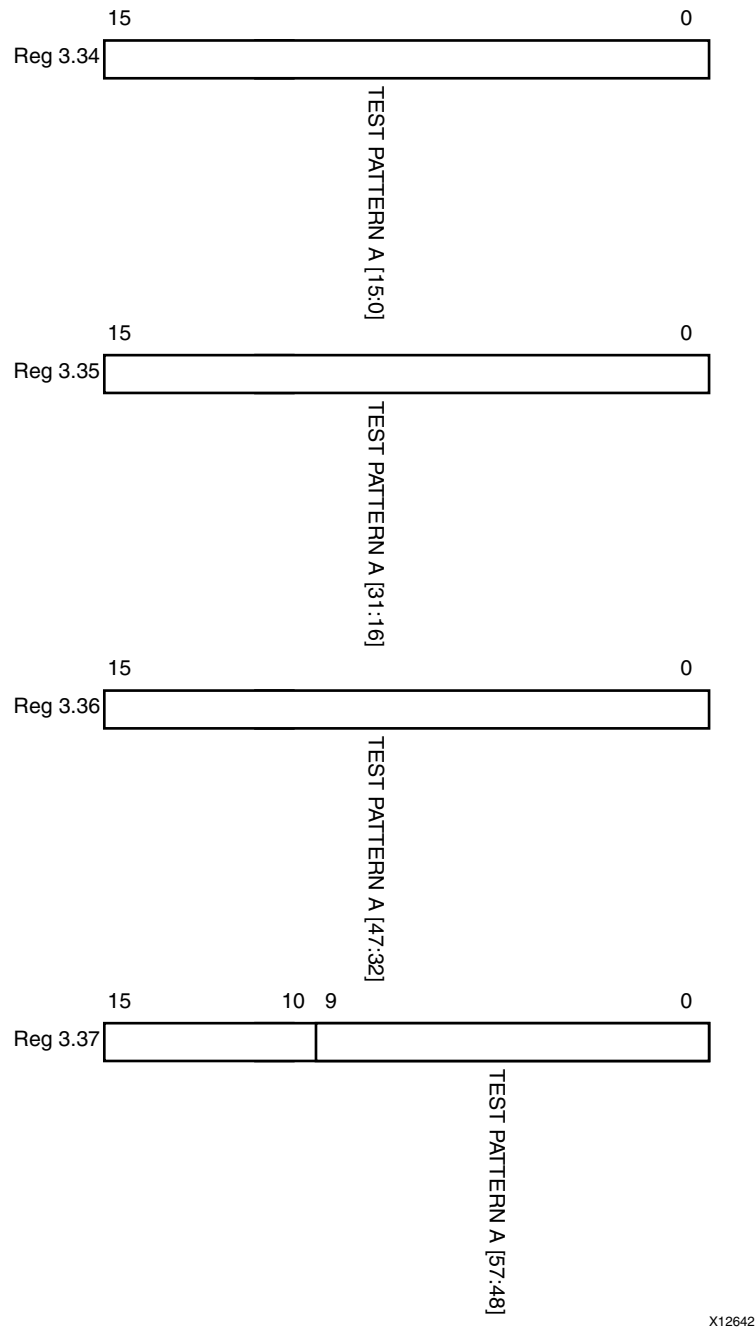

Figure 2-35: 10GBASE-R Test Pattern Seed A0-3 Registers

Table 2-48 shows the 10GBASE-R Test Pattern Seed A0-2 register bit definitions.

Table 2-48: 10GBASE-R Test Pattern Seed A0-2 Register Bit Definitions

Bit(s)	Name	Description	Attributes	Default Value
3.34-36.15:0 3.37.9:0	Seed A bits 15:0, 31:16, 47:32, 57:48 resp	Seed for PRBS testing	R/W	Virtex-6: 3.34.0 = 1, all other bits = 0 V7/K7: all '0's

MMDIO Register 3.38-41: 10GBASE-R Test Pattern Seed B0-3

Figure 2-36 shows the MDIO Register 3.38-41: 10GBASE-R Test Pattern Seed B.

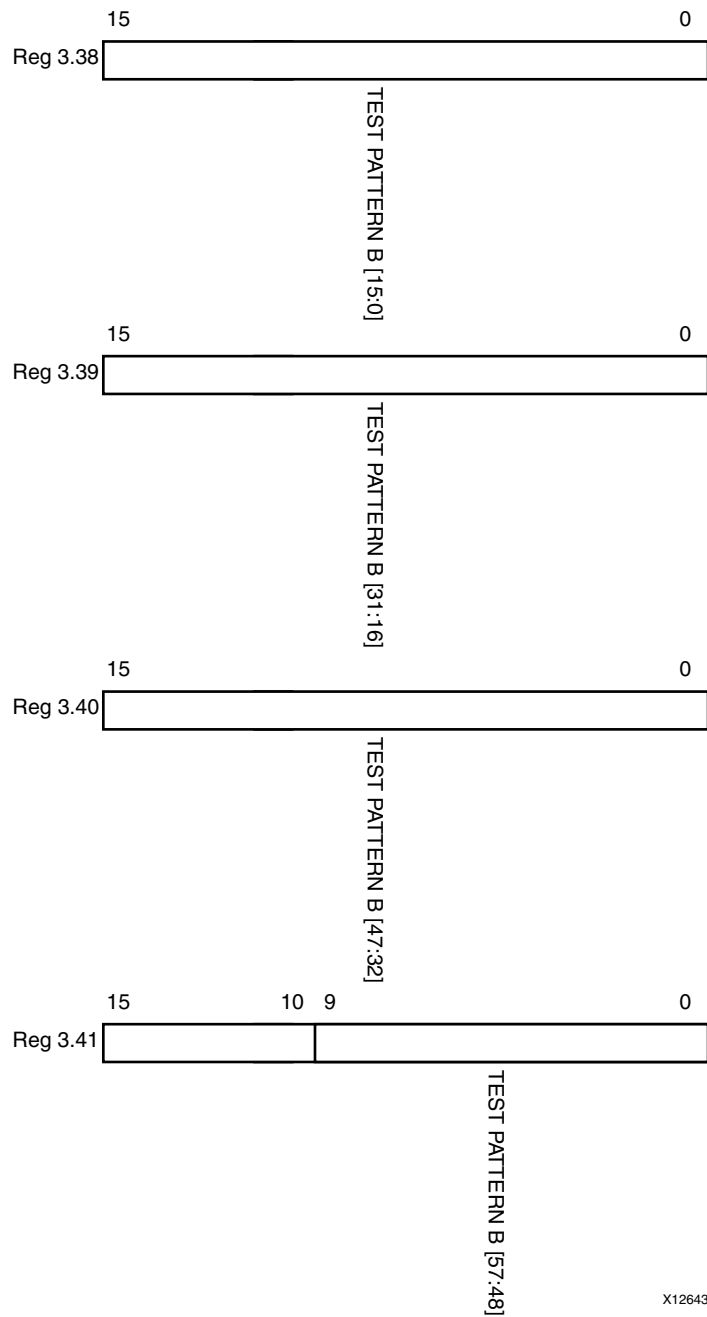

Figure 2-36: 10GBASE-R Test Pattern Seed B0-3 Registers

Table 2-49 shows the 10GBASE-R Test Pattern Seed B0-3 register bit definitions.

Table 2-49: 10GBASE-R Test Pattern Seed B0-3 Register Bit Definitions

Bit(s)	Name	Description	Attributes	Default Value
3.38-40.15:0 3.41.9:0	Seed B bits 15:0, 31:16, 47:32, 57:48 resp	Seed for PRBS testing	R/W	Virtex-6: 3.38.0 = 1, all other bits = 0 V7/K7: all '0's

MDIO Register 3.42: 10GBASE-R Test Pattern Control

Figure 2-37 shows the MDIO Register 3.42: 10GBASE-R Test Pattern Control.

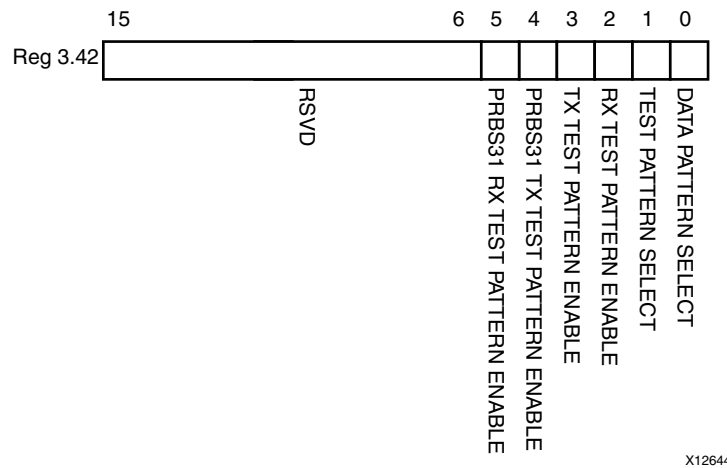

Figure 2-37: 10GBASE-R Test Pattern Control Register

Table 2-50 shows the 10GBASE-R Test Pattern Control register bit definitions.

Table 2-50: 10GBASE-R Test Pattern Control Register Bit Definitions

Bit(s)	Name	Description	Attributes	Default Value
3.42.15:6	Reserved	The block always returns '0's for these bits.	R/O	All 0s
3.42.5	PRBS31 RX test pattern enable	1 = Enable PRBS RX tests 0 = Disable PRBS RX tests	R/W	0
3.42.4	PRBS31 TX test pattern enable	1 = Enable PRBS TX tests 0 = Disable PRBS TX tests	R/W	0
3.42.3	TX test pattern enable	Enables the TX Test Pattern which has been selected with bits [1:0].	R/W	0
3.42.2	RX test pattern enable	Enables the RX Test Pattern Checking which has been selected with bits [1:0]	R/W	0

Table 2-50: 10GBASE-R Test Pattern Control Register Bit Definitions (Cont'd)

Bit(s)	Name	Description	Attributes	Default Value
3.42.1	Test pattern select	1 = Square wave 0 = Pseudo-Random	R/W	0
3.42.0	Data pattern select	1 = Zeros pattern 0 = LF Data pattern	R/W	0

MDIO Register 3.43: 10GBASE-R Test Pattern Error Counter

Figure 2-38 shows the MDIO Register 3.43: 10GBASE-R Test Pattern Error Counter.

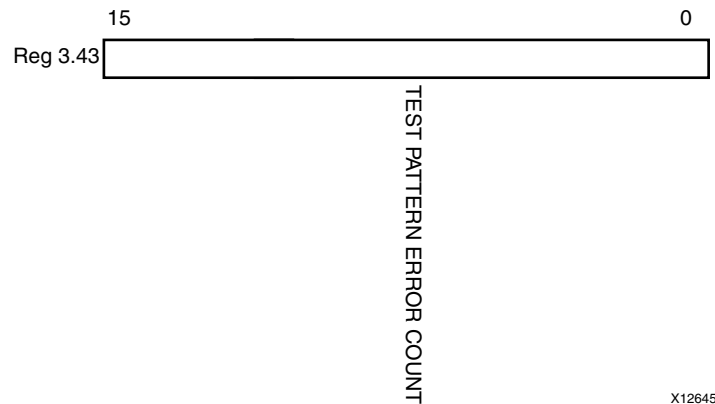

Figure 2-38: 10GBASE-R Test Pattern Error Counter Register

Table 2-51 shows the 10GBASE-R Test Pattern Error Counter register bit definitions. This register is cleared when read.

Table 2-51: 10GBASE-R Test Pattern Error Counter Register Bit Definitions

Bit(s)	Name	Description	Attributes	Default Value
3.43.15:0	Test pattern error counter	Count of errors	R/O	All 0s

MDIO Register 3.32768: Vendor-Specific PCS Loopback Control - Virtex-6 FPGAs Only

Figure 2-39 shows the MDIO 3.32768 Register: Vendor-Specific PCS Loopback Control. Consult UG371, *Virtex-6 FPGA GTH Transceivers User Guide* for details.

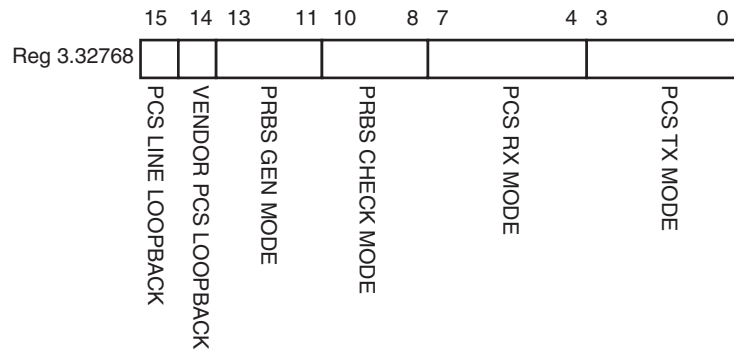

Figure 2-39: Vendor-Specific PCS Loopback Control Register

Table 2-52: Vendor-Specific PCS Loopback Control

Bit(s)	Name	Description	Attributes	Default Value
3.32768.15	PCS Line Loopback	1 = Loopback SerDes RX to SerDes TX	R/W	'0'
3.32768.14	Vendor PCS Loopback	1 = Loopback PCS TX to PCS RX	R/W	'0'
3.32768.13:11	PRBS Gen Mode	000: None 001: PRBS7 010: PRBS9 011: PRBS11 100: PRBS23 101: PRBS31 110: PPAT 111: Reserved	R/W	'000' Values other than '000' and '101' have no effect.
1.32768.10:8	PRBS Check Mode	000: None 001: PRBS7 010: PRBS9 011: PRBS11 100: PRBS23 101: PRBS31 110: PPAT 111: Reserved	R/W	'000' Values other than '000' and '101' have no effect.

Table 2-52: Vendor-Specific PCS Loopback Control (Cont'd)

Bit(s)	Name	Description	Attributes	Default Value
3.32768.7:4	PCS RX Mode	0000: Zero 0001: 64/66b 0010: XAUI 0011: Reserved 0100: PCIE® 0101: PCIE-500 (fixed PCLK 500MHz) 0110: 8B/10B 8-bit 0111: 8B/10B 16-bit 1000: 8-bit raw data 1001: 10-bit raw data 1010: 16-bit raw data 1011: 20-bit raw data 1100: PRBS 1101: Reserved 1110: 1000 Base-KX 1111: 802.3ap	R/W	Set from GTH transceiver PCS_MODE Attribute = '0001' Do not write any other values to these bits.
3.32768.3:0	PCS TX Mode	0000: Zero 0001: 64/66b 0010: XAUI 0011: Reserved 0100: PCIE 0101: PCIE-500 (fixed PCLK 500MHz) 0110: 8B/10B8-bit 0111: 8B/10B8 16-bit 1000: 8-bit raw data 1001: 10-bit raw data 1010: 16-bit raw data 1011: 20-bit raw data 1100: PRBS 1101: Reserved 1110: 1000 Base-KX 1111: 802.3ap	R/W	Set from GTH PCS_MODE Attribute = '0001' Do not write any other values to these bits.

MDIO Register 3.65535: 125 μ s Timer Control - Virtex-7/Kintex-7 FPGAs Only

Figure 2-40 shows the MDIO 3.65535 Register: 125 μ s timer control.

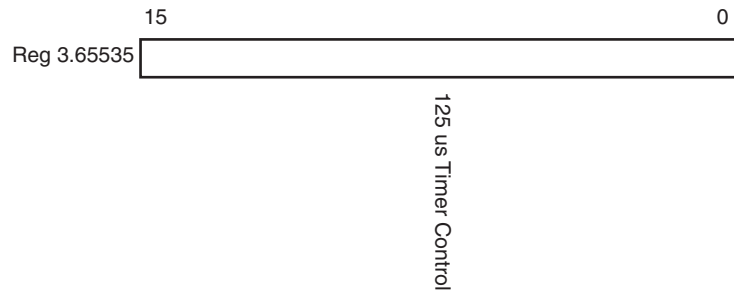

Figure 2-40: 125 μ s Timer Control Register

Table 2-53: 125 μ s Timer Control

Bit(s)	Name	Description	Attributes	Default Value
3.65535.15:0	125 μ s timer control	Bits 15..0 set the number of clock cycles at 156.25MHz to be used to measure the 125 μ s timer in the BER monitor state machine. Useful for debug purposes (simulation speedup).	R/W	x'4C4B'

MDIO Register 7.0: AN Control

Figure 2-41 shows the MDIO Register 7.0: AN Control.

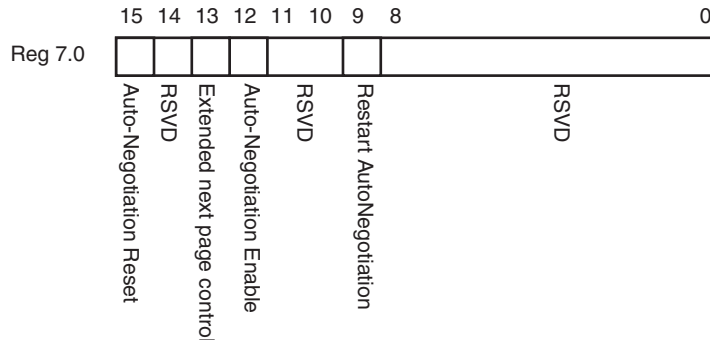

Figure 2-41: AN Control Register

Table 2-54 shows the AN Control register bit definitions.

Table 2-54: AN Control Register Bit Definitions

Bit(s)	Name	Description	Attributes	Default Value
7.0.15	AN Reset	1 = AN Reset 0 = AN normal operation	R/W Self-clearing	0
7.0.14	Reserved	The block always returns '0' for this bit and ignores writes.	R/O	0
7.0.13	Extended Next Page control	1 = Extended Next Pages are supported 0 = Not supported	R/W	0
7.0.12	AN Enable	1 = Enable AN Process 0 = Disable	R/W ^a	1
7.0.11:10	Reserved	The block always returns '0' for this bit and ignores writes.	R/O	00
7.0.9	Restart AN	1 = Restart AN process 0 = Normal operation	R/W Self-clearing	0
7.0.8:0	Reserved	The block always returns '0' for this bit and ignores writes.	R/O	0's

a. For simulation purposes only, to disable AN at start-up, the external core pin 'an_enable' should be tied low.

MDIO Register 7.1: AN Status

Figure 2-42 shows the MDIO Register 7.1: AN Status.

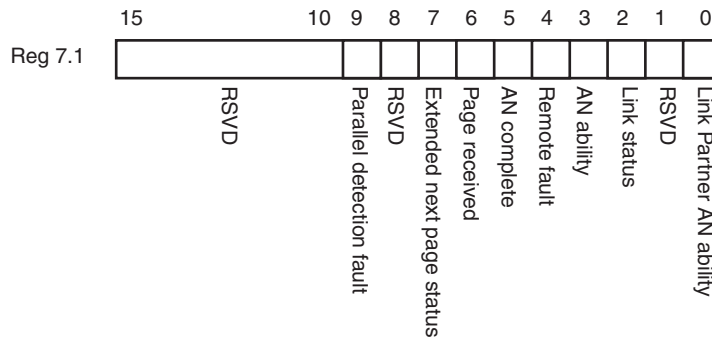

Figure 2-42: AN Status Register

Table 2-55 shows the AN Status register bit definitions.

Table 2-55: AN Status Register Bit Definitions

Bit(s)	Name	Description	Attributes	Default Value
7.1.15:10	Reserved	The block always returns '0' for this bit and ignores writes.	R/O	0's
7.1.9	Parallel Detection Fault	1 = A fault has been detected through the parallel detection function 0 = no fault detected	R/O Latches High	0
7.1.8	Reserved	The block always returns '0' for this bit and ignores writes.	R/O	0
7.1.7	Extended Next Page status	1 = XNP format is used 0 = XNP format is not allowed	R/O	0
7.1.6	Page Received	1 = A page has been received 0 = No page received	R/O Latches High	0
7.1.5	AN Complete	1 = AN process has completed 0 = not completed	R/O	0
7.1.4	Remote fault	1 = remote fault condition detected 0 = not detected	R/O Latches High	0
7.1.3	AN ability	1 = PHY supports auto-negotiation 0 = PHY does not support auto-negotiation	R/O	1
7.1.2	Link status	1 = Link is up 0 = Link is down	R/O Latches Low	0

Table 2-55: AN Status Register Bit Definitions (Cont'd)

Bit(s)	Name	Description	Attributes	Default Value
7.1.1	Reserved	The block always returns '0' for this bit and ignores writes.	R/O	0
7.1.0	LP AN ability	1 = LP is able to perform AN 0 = not able	R/O	0

MDIO Register 7.16:17:18: AN Advertisement

Figure 2-43 shows the MDIO Register 7.16: AN Advertisement.

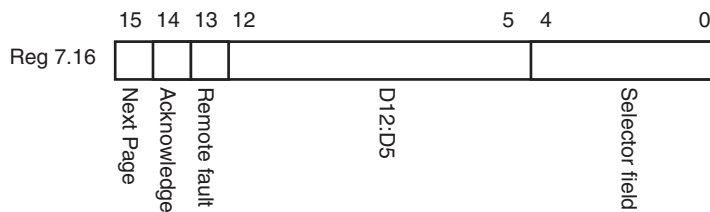

Figure 2-43: AN Advertisement Register 0

Table 2-56 shows the AN Advertisement register bit definitions.

Table 2-56: AN Advertisement Register 0 Bit Definitions

Bit(s)	Name	Description	Attributes	Default Value
7.16.15	Next Page	Consult IEEE802.3	R/W	0
7.16.14	Acknowledge	The block always returns '0' for this bit and ignores writes.	R/O	0
7.16.13	Remote Fault	Consult IEEE802.3	R/W	0
7.16.12:5	D12:D5	Consult IEEE802.3	R/W	0's
7.16.4:0	Selector Field	Consult IEEE802.3	R/W	0's

Figure 2-44 shows the MDIO Register 7.17: AN Advertisement.

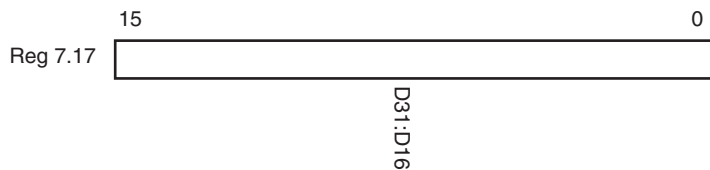

Figure 2-44: AN Advertisement Register 1

Table 2-57 shows the AN Advertisement register bit definitions.

Table 2-57: AN Advertisement Register 1 Bit Definitions

Bit(s)	Name	Description	Attributes	Default Value
7.17.15:0	D31:D16	Consult IEEE802.3	R/W	0

Figure 2-45 shows the MDIO Register 7.18: AN Advertisement.

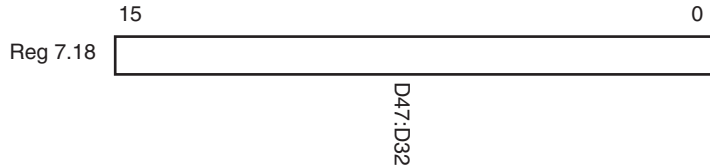

Figure 2-45: AN Advertisement Register 2

Table 2-58 shows the AN Advertisement register bit definitions.

Table 2-58: AN Advertisement Register 2 Bit Definitions

Bit(s)	Name	Description	Attributes	Default Value
7.18.15:0	D47:D32	Consult IEEE802.3	R/W	0

MDIO Register 7.19, 20, 21: AN LP Base Page Ability

Figure 2-46 shows the MDIO Register 7.19: AN LP Base Page Ability.

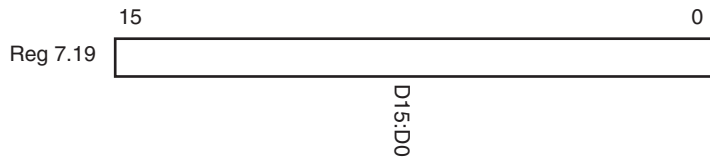

Figure 2-46: AN LP Base Page Ability Register 0

Table 2-59 shows the AN LP Base Page Ability register bit definitions.

Table 2-59: AN LP Base Page Ability Register 0 Bit Definitions

Bit(s)	Name	Description	Attributes	Default Value
7.19.15:0	D15:D0	Consult IEEE802.3	R/O	0

Figure 2-47 shows the MDIO Register 7.20: AN LP Base Page Ability.

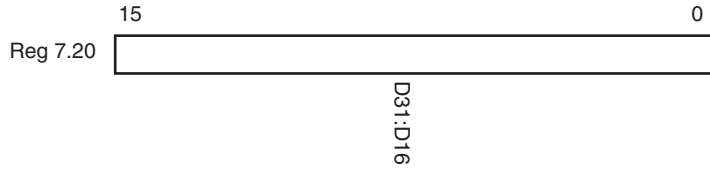

Figure 2-47: AN LP Base Page Ability Register 1

Table 2-60 shows the AN LP Base Page Ability register bit definitions.

Table 2-60: AN LP Base Page Ability Register 1 Bit Definitions

Bit(s)	Name	Description	Attributes	Default Value
7.20.15:0	D31:D16	Consult IEEE802.3	R/W	0

Figure 2-48 shows the MDIO Register 7.21: AN LP Base Page Ability.

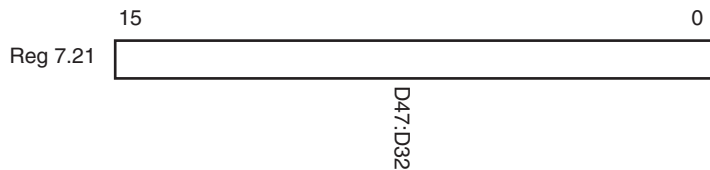

Figure 2-48: AN LP Base Page Ability Register 2

Table 2-61 shows the AN LP Base Page Ability register bit definitions.

Table 2-61: AN LP Base Page Ability Register 2 Bit Definitions

Bit(s)	Name	Description	Attributes	Default Value
7.21.15:0	D47:D32	Consult IEEE802.3	R/W	0

MDIO Register 7.22, 23, 24: AN XNP Transmit

Figure 2-49 shows the MDIO Register 7.22: AN XNP Transmit.

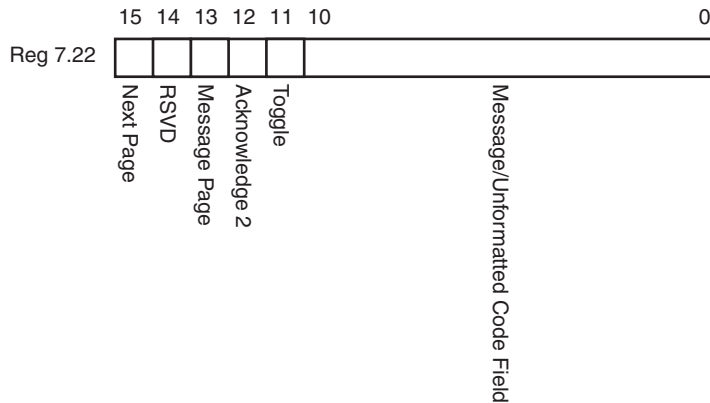

Figure 2-49: AN XNP Transmit Register 0

Table 2-62 shows the AN XNP Transmit register bit definitions.

Table 2-62: AN XNP Transmit Register 0 Bit Definitions

Bit(s)	Name	Description	Attributes	Default Value
7.22.15	Next Page	Consult IEEE802.3	R/W	0
7.22.14	Reserved	The block always returns '0' for this bit and ignores writes.	R/O	0
7.22.13	Message Page	Consult IEEE802.3	R/W	0
7.22.12	Acknowledge 2	Consult IEEE802.3	R/W	0
7.22.11	Toggle	Consult IEEE802.3	R/O	0
7.22.10:0	Message/Unformatted Code Field	Consult IEEE802.3	R/W	0's

Figure 2-50 shows the MDIO Register 7.23: AN XNP Transmit.

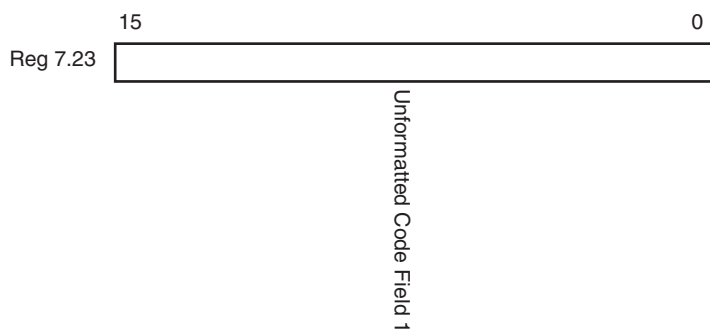

Figure 2-50: AN XNP Transmit Register 1

Table 2-63 shows the AN XNP Transmit register bit definitions.

Table 2-63: AN XNP Transmit Register 1 Bit Definitions

Bit(s)	Name	Description	Attributes	Default Value
7.23.15:0	Unformatted Code Field 1	Consult IEEE802.3	R/W	0's

Figure 2-51 shows the MDIO Register 7.24: AN XNP Transmit.

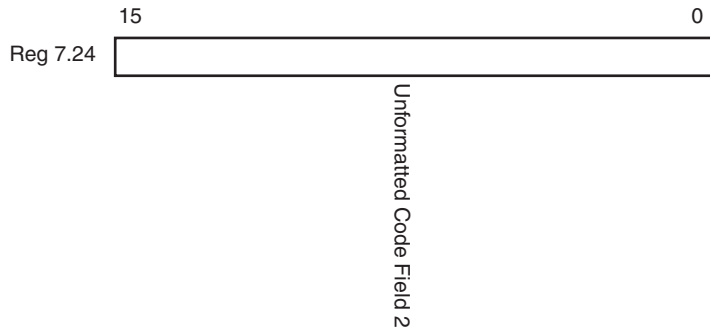

Figure 2-51: AN XNP Transmit Register 2

Table 2-64 shows the AN XNP Transmit register bit definitions.

Table 2-64: AN XNP Transmit Register 2 Bit Definitions

Bit(s)	Name	Description	Attributes	Default Value
7.24.15:0	Unformatted Code Field 2	Consult IEEE802.3	R/W	0's

MDIO Register 7.25, 26, 27: AN LP XNP Ability

Figure 2-52 shows the MDIO Register 7.25: AN LP XNP Ability.

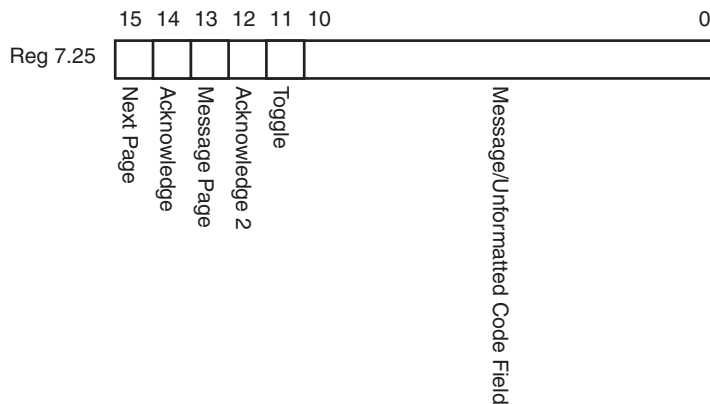

Figure 2-52: AN LP XNP Ability Register 0

Table 2-65 shows the AN LP XNP Ability register bit definitions.

Table 2-65: AN LP XNP Ability Register 0 Bit Definitions

Bit(s)	Name	Description	Attributes	Default Value
7.25.15	Next Page	Consult IEEE802.3	R/O	0
7.25.14	Acknowledge	Consult IEEE802.3	R/O	0
7.25.13	Message Page	Consult IEEE802.3	R/O	0
7.25.12	Acknowledge 2	Consult IEEE802.3	R/O	0
7.25.11	Toggle	Consult IEEE802.3	R/O	0
7.25.10:0	Message/ Unformatted Code Field	Consult IEEE802.3	R/O	0's

Figure 2-53 shows the MDIO Register 7.26: AN LP XNP Ability.

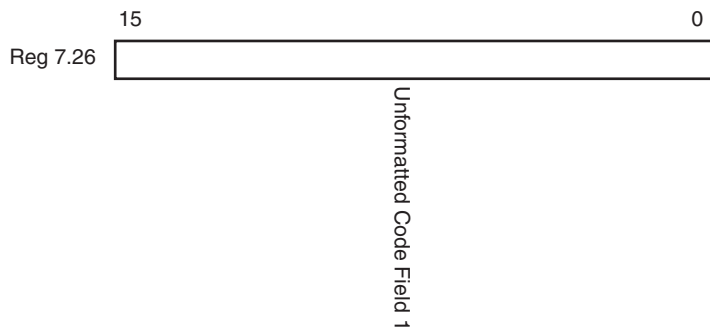

Figure 2-53: AN LP XNP Ability Register 1

Table 2-66 shows the AN LP XNP Ability register bit definitions.

Table 2-66: AN LP XNP Ability Register 1 Bit Definitions

Bit(s)	Name	Description	Attributes	Default Value
7.26.15:0	Unformatted Code Field 1	Consult IEEE802.3	R/O	0's

Figure 2-54 shows the MDIO Register 7.27: AN LP XNP Ability.

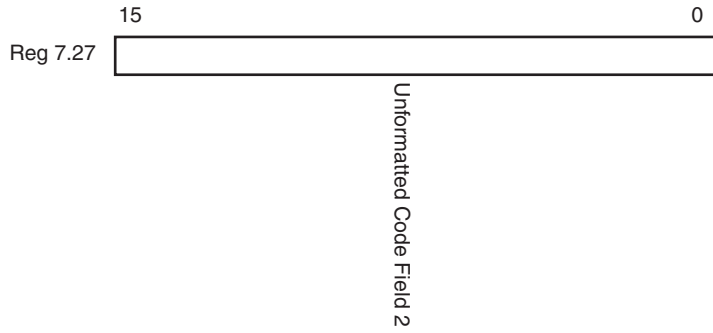

Figure 2-54: AN LP XNP Ability Register 2

Table 2-67 shows the AN LP XNP Ability register bit definitions.

Table 2-67: AN LP XNP Ability Register 2 Bit Definitions

Bit(s)	Name	Description	Attributes	Default Value
7.27.15:0	Unformatted Code Field 2	Consult IEEE802.3	R/O	0's

MDIO Register 7.48: Backplane Ethernet Status

Figure 2-55 shows the MDIO Register 7.48: Backplane Ethernet Status.

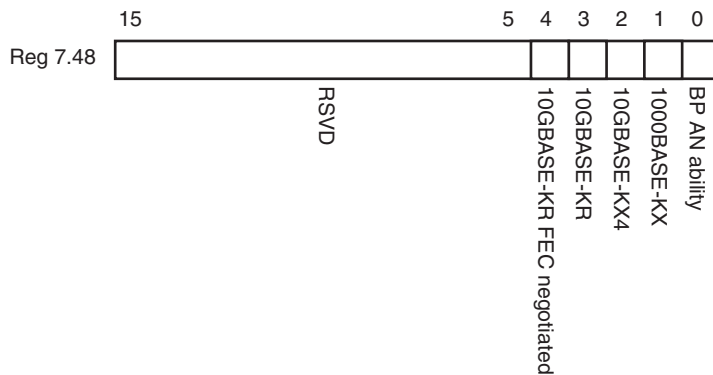

Figure 2-55: Backplane Ethernet Status Register

Table 2-68 shows the Backplane Ethernet Status register bit definitions.

Table 2-68: Backplane Ethernet Status Register Bit Definitions

Bit(s)	Name	Description	Attributes	Default Value
7.48.15:5	Reserved	The block always returns '0' for this bit and ignores writes.	R/O	0
7.48.4	10GBASE-KR FEC negotiated	1 = PMA/PMD is negotiated to perform 10GBASE-KR FEC 0 = not negotiated	R/O	0
7.48.3	10GBASE-KR	1 = PMA/PMD is negotiated to perform 10GBASE-KR 0 = not negotiated	R/O	0
7.48.2	10GBASE-KX4	1 = PMA/PMD is negotiated to perform 10GBASE-KX4 0 = not negotiated	R/O	0
7.48.1	1000GBASE-KX	1 = PMA/PMD is negotiated to perform 1000GBASE-KX 0 = not negotiated	R/O	0
7.48.0	BP AN ability	1 = PMA/PMD is able to perform one of the preceding protocols 0 = not able	R/O	1

Designing with the Core

This chapter provides a general description of how to use the 10GBASE-R/KR core in your designs as well as describing specific core interfaces.

This chapter also describes the steps required to turn a 10GBASE-R/KR core into a fully-functioning design with user-application logic. It is important to realize that not all implementations require all of the design steps listed in this chapter. Follow the logic design guidelines in this manual carefully.

General Design Guidelines

Use the Example Design as a Starting Point

Each instance of the 10GBASE-R/KR core created by the CORE Generator™ tool is delivered with an example design that can be implemented in an FPGA and simulated. This design can be used as a starting point for your own design or can be used to sanity-check your application in the event of difficulty.

See [Chapter 9, Detailed Example Design](#), for information about using and customizing the example designs for the 10GBASE-R/KR core.

Know the Degree of Difficulty

10GBASE-R/KR designs are challenging to implement in any technology, and the degree of difficulty is further influenced by:

- Maximum system clock frequency
- Targeted device architecture
- Nature of your application

All 10GBASE-R/KR implementations need careful attention to system performance requirements. Pipelining, logic mapping, placement constraints, and logic duplication are all methods that help boost system performance.

Keep It Registered

To simplify timing and increase system performance in an FPGA design, keep all inputs and outputs registered between your application and the core. This means that all inputs and outputs from your application should come from, or connect to a flip-flop. While registering signals cannot be possible for all paths, it simplifies timing analysis and makes it easier for the Xilinx tools to place and route the design.

Recognize Timing Critical Signals

The timing constraint file that is provided with the example design for the core identifies the critical signals and the timing constraints that should be applied. See [Chapter 5, Constraining the Core](#) (Vivado™ tools) and [Chapter 8, Constraining the Core](#) (ISE® tools) for further information.

Use Supported Design Flows

See [Chapter 4, Customizing and Generating the Core](#) (Vivado design tools) and [Chapter 7, Customizing and Generating the Core](#) (ISE design tools) for more information.

Make Only Allowed Modifications

The 10GBASE-R/KR core is not user-modifiable. Do not make modifications as they can have adverse effects on system timing and protocol compliance. Supported user configurations of the 10GBASE-R/KR core can only be made by selecting the options from within the CORE Generator tool or Vivado IP Catalog when the core is generated. See [Chapter 4, Customizing and Generating the Core](#) (Vivado tools) and [Chapter 7, Customizing and Generating the Core](#) (CORE Generator tool).

Interfacing to the Core

Data Interface: Internal Interfaces

Internal 64-bit SDR Client-side Interface

The 64-bit single-data rate (SDR) client-side interface is based upon the 32-bit XGMII interface. The bus is demultiplexed from 32-bits wide to 64-bits wide on a single rising clock edge. This demultiplexing is done by extending the bus upwards so that there are now eight lanes of data numbered 0-7; the lanes are organized such that data appearing on lanes 4-7 is transmitted or received *later* in time than that in lanes 0-3.

The mapping of lanes to data bits is shown in [Table 3-1](#). The lane number is also the index of the control bit for that particular lane; for example, `xgmii_txc[2]` and `xgmii_txd[23:16]` are the control and data bits respectively for lane 2.

Table 3-1: XGMII_TXD, XGMII_RXD Lanes for Internal 64-bit Client-Side Interface

Lane	XGMII_TXD, XGMII_RXD Bits
0	7:0
1	15:8
2	23:16
3	31:24
4	39:32
5	47:40
6	55:48
7	63:56

Definitions of Control Characters

Reference is regularly made to certain XGMII control characters signifying Start, Terminate, Error, and so forth. These control characters all have in common that the control line for that lane is '1' for the character and a certain data byte value. The relevant characters are defined in the *IEEE Std. 802.3-2008* and are reproduced in [Table 3-2](#) for reference.

Table 3-2: Partial list of XGMII Characters

Data (Hex)	Control	Name, Abbreviation
00 to FF	'0'	Data (D)
07	'1'	Idle (I)
FB	'1'	Start (S)
FD	'1'	Terminate (T)
FE	'1'	Error (E)

Interfacing to the Transmit Client Interface

Internal 64-bit Client-Side Interface

The timing of a data frame transmission through the internal 64-bit client-side interface is shown in [Figure 3-1](#). The beginning of the data frame is shown by the presence of the Start character (the /S/ codegroup in lane 4 of [Figure 3-1](#)) followed by data characters in lanes 5, 6, and 7. Alternatively the start of the data frame can be marked by the occurrence of a Start character in lane 0, with the data characters in lanes 1 to 7.

When the frame is complete, it is completed by a Terminate character (the T in lane 1 of Figure 3-1). The Terminate character can occur in any lane; the remaining lanes are padded by XGMII idle characters.

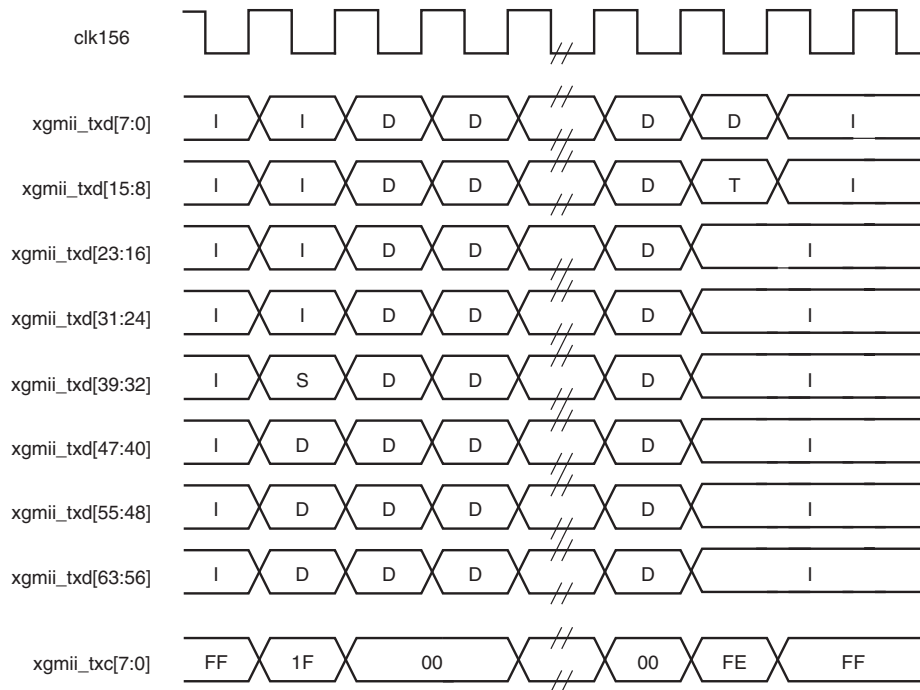

Figure 3-1: Normal Frame Transmission Across the Internal 64-bit Client-Side I/F

Figure 3-2 depicts a similar frame to that in Figure 3-1, with the exception that this frame is propagating an error. The error code is denoted by the letter E, with the relevant control bits set.

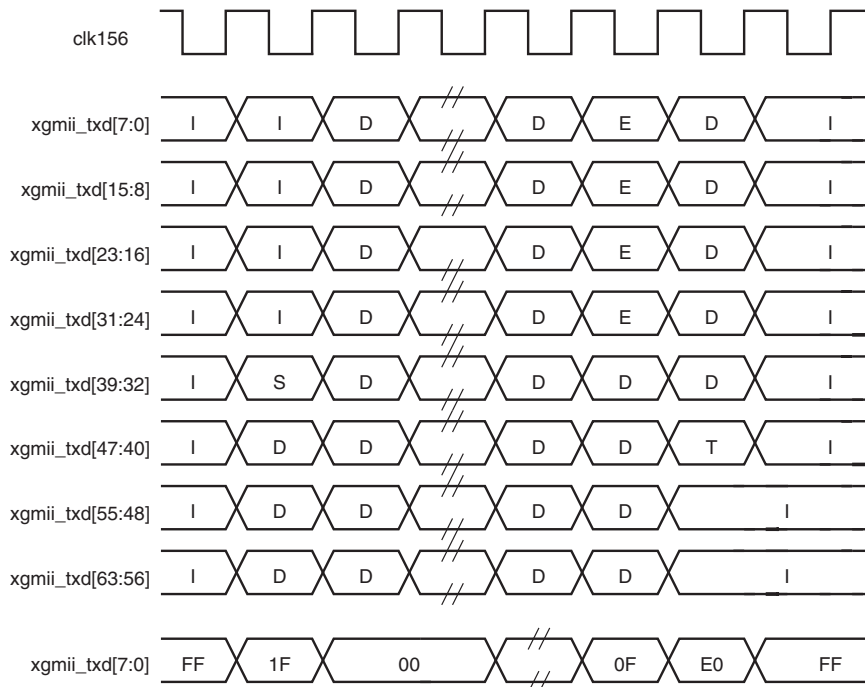

Figure 3-2: Frame Transmission with Error Across Internal 64-bit Client-Side I/F

Interfacing to the Receive Client Interface

Internal 64-bit Client-Side Interface

The timing of a normal inbound frame transfer is shown in [Figure 3-3](#). As in the transmit case, the frame is delimited by a Start character (S) and by a Terminate character (T). The Start character in this implementation can occur in either lane 0 or in lane 4. The Terminate character, T, can occur in any lane.

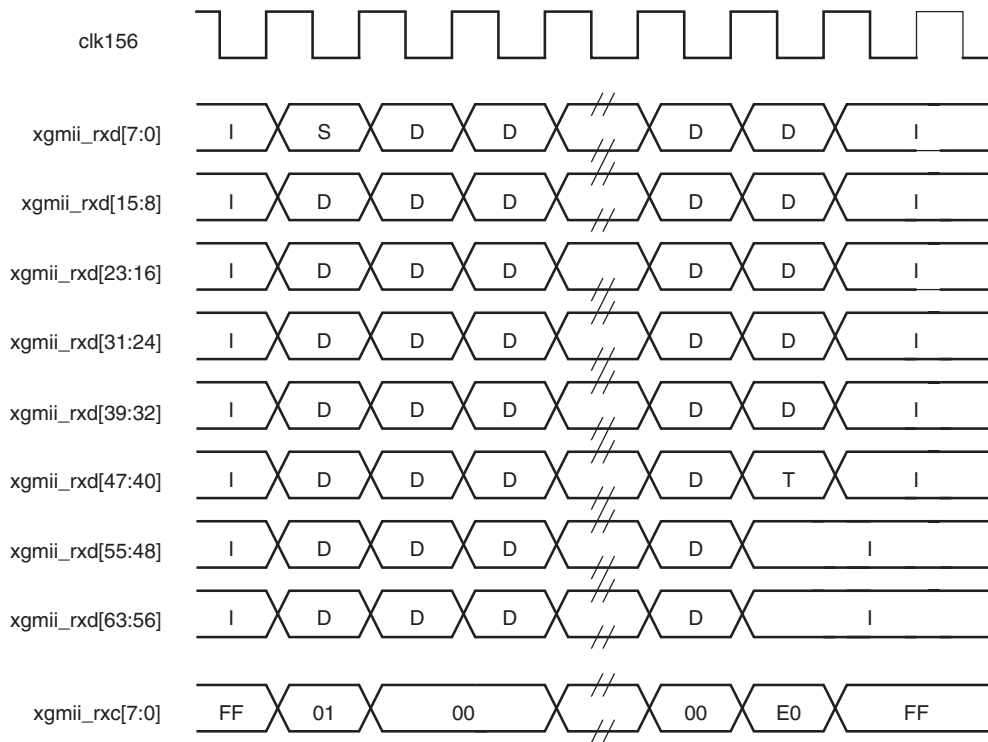

Figure 3-3: Frame Reception Across the Internal 64-bit Client Interface

Figure 3-4 shows an inbound frame of data propagating an error. In this instance, the error is propagated in lanes 4 to 7, shown by the letter E.

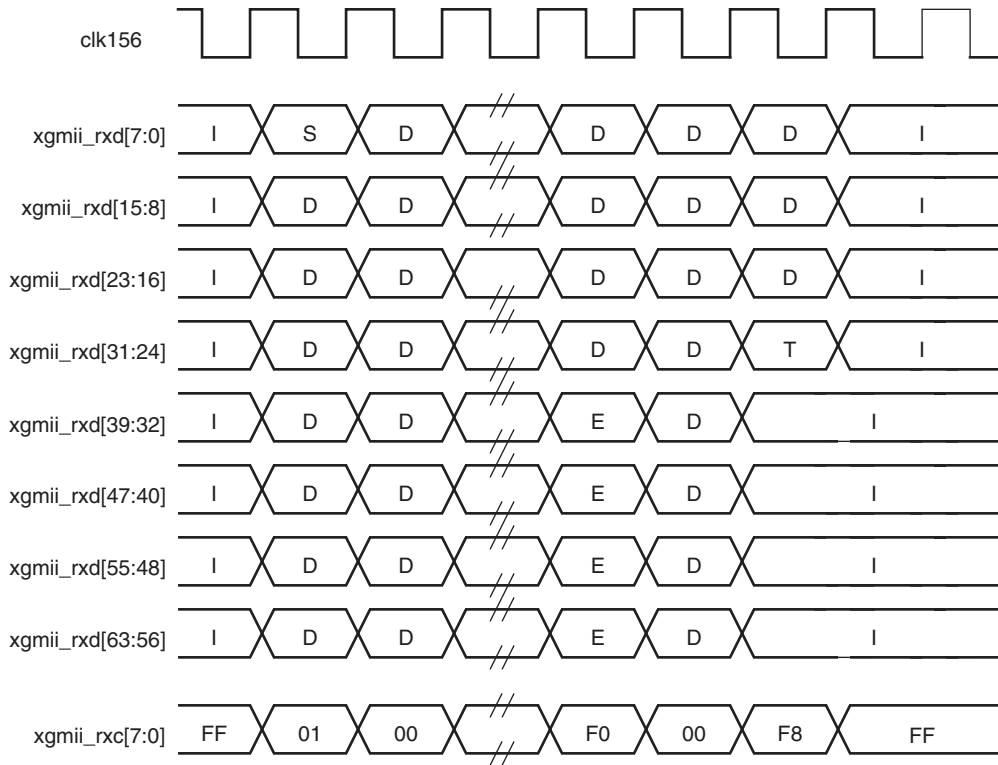

Figure 3-4: Frame Reception with Error Across the Internal 64-bit Client Interface

Interfacing to the Transceivers

Virtex-7/Kintex-7 FPGAs

Table 3-3: Transceiver Interface Ports for Virtex-7/Kintex-7 FPGA GTX/GTH Transceivers

Signal Name	Direction	Description
gt_txd[31:0]	Out	64-bit transmit data word
gt_txc[1:0]	Out	2-bit transmit sync header
gt_txc[7:2]	Out	6-bit TXSEQUENCE count (0..32)
gt_rxd[31:0]	In	64-bit receive data word
gt_rxc[1:0]	In	2-bit receive sync header
gt_rxc[2]	In	RXDATAVALID (high for 64 in 66 rxusrclk2 cycles)
gt_rxc[3]	In	RXHEADERVALID (high on alternate cycles of rxusrclk2, when RXDATAVALID is high)
gt_rxc[7:4]	In	Not Used
gt_slip	In	RXGEARBOXSLIP on transceiver
tx_prbs31_en	Out	Transmit PRBS31 pattern enable
rx_prbs31_en	Out	Enable Receive PRBS31 pattern checking
clear_rx_prbs_err_count	Out	Signal to transceiver to clear the RX PRBS31 error counter.
loopback_ctl[2:0]	Out	Control for transceiver internal loopback
resetdone	In	Signal from the transceiver wrapper logic
drp_req	Out	Request access to the transceiver DRP port (not connected in example design)
drp_gnt	In	Access to transceiver DRP port is granted (not connected in example design)
drp_den	Out	Enable DRP
drp_dwe	Out	DRP Write Enable
drp_daddr[15:0]	Out	DRP address
drp_di[15:0]	Out	DRP Write data
drp_drdy	In	DRP Data Ready
drp_drpdo[15:0]	In	DRP Read data

The remainder of the device-specific transceiver ports are not connected to the netlist, but are connected in the core source code (block-level and transceiver wrapper files) or are wired to static values.

No timing diagrams are presented here for the device-specific transceiver signals. You should treat this interface as a black box. If customization of this interface is required, see *7 Series Transceiver User Guide* (UG476) for detailed descriptions of the transceiver ports.

Virtex-6 HXT FPGAs

Table 3-4: Transceiver Interface Ports for Virtex-6 FPGA GTH Transceivers

Signal Name	Direction	Description
gt_txd[63:0]	OUT	Transceiver transmit data
gt_txc[7:0]	OUT	Transceiver transmit control signals
gt_rxd[63:0]	IN	Transceiver receive data
gt_rxc[7:0]	IN	Transceiver receive control signals

The remainder of the device-specific transceiver ports are not connected to the netlist, but are connected in the core source code (block-level and transceiver wrapper files) or are wired to static values.

No timing diagrams are presented here for the device-specific transceiver signals. You should treat this interface as a black box. If customization of this interface is required, see the *Virtex-6 FPGA GTH Transceivers User Guide* for detailed descriptions of the transceiver ports.

The following sections describe the interfaces available for dynamically setting the configuration and obtaining the status of the 10GBASE-R/KR core. There are two interfaces for configuration; depending on the core customization, only one is available in a particular core instance.

Configuration and Status Interfaces

This section describes the interfaces available for dynamically setting the configuration and obtaining the status of the 10GBASE-R/KR core. There are two interfaces for configuration; depending on the core customization, only one is available in a particular core instance. The interfaces are:

- [MDIO Interface](#)
- [Configuration and Status Vectors](#)

MDIO Interface

The Management Data Input/Output (MDIO) interface is a simple, low-speed 2-wire interface for management of the 10GBASE-R/KR core consisting of a clock signal and a bidirectional data signal. It is defined in clause 45 of *IEEE Standard 802.3-2008*.

An MDIO bus in a system consists of a single Station Management (STA) master management entity and several MDIO Managed Device (MMD) slave entities. [Figure 3-5](#) illustrates a typical system. All transactions are initiated by the STA entity. The 10GBASE-R/KR core implements an MMD.

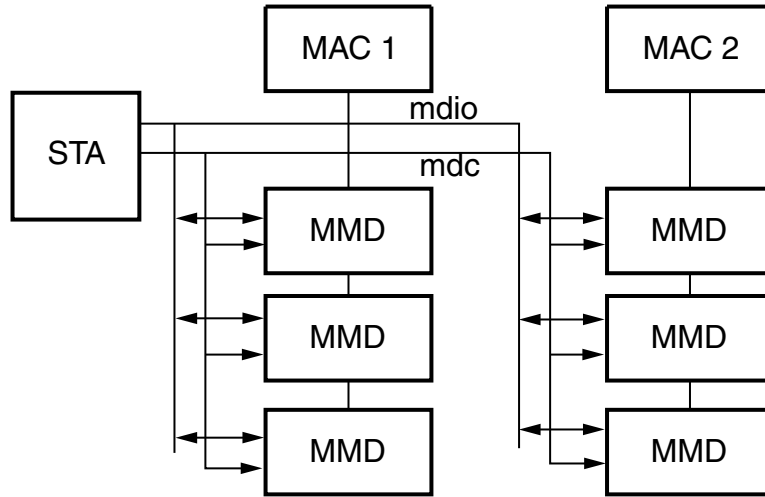

Figure 3-5: A Typical MDIO-Managed System

MDIO Ports

The core ports associated with MDIO are shown in Table 3-5.

Table 3-5: MDIO Management Interface Port Description

Signal Name	Direction	Description
mdc	IN	Management clock
mdio_in	IN	MDIO input
mdio_out	OUT	MDIO output
mdio_tri	OUT	MDIO 3-state. '1' disconnects the output driver from the MDIO bus.
prtad[4:0]	IN	MDIO port address

If implemented, the MDIO interface is implemented as four unidirectional signals. These can be used to drive a 3-state buffer either in the FPGA SelectIO™ interface buffer or in a separate device.

The `prtad[4:0]` port sets the port address of the core instance. Multiple instances of the same core can be supported on the same MDIO bus by setting the `prtad[4:0]` to a unique value for each instance; the 10GBASE-R/KR core ignores transactions with the PRTAD field set to a value other than that on its `prtad[4:0]` port.

MDIO Transactions

The MDIO interface should be driven from a STA master according to the protocol defined in *IEEE Std. 802.3-2008*. An outline of each transaction type is described in the following sections. In these sections, these abbreviations apply:

- PRE: preamble
- ST: start
- OP: operation code
- PRTAD: port address
- DEVAD: device address
- TA: turnaround

DEVAD

Virtex-6 FPGAs

The device address in this case will be either "00001" for the PMA device or "00011" for the PCS device, both of which are implemented in the GTH transceiver. MDIO transactions with a DEVAD other than those two values are ignored.

Virtex-7/Kintex-7 FPGAs

The device address in this case will be either "00001" for the PMA device or "00011" for the PCS device. For BASE-KR cores that include the optional Autonegotiation block, a DEVAD of "00111" should be used to access the associated registers.

Set Address Transaction

Figure 3-6 shows an Address transaction defined by OP='00.' Set Address is used to set the internal 16-bit address register which is particular to the given DEVAD, for subsequent data transactions (called the "current address" in the following sections). The core contains two such address registers, one for PCS and one for PMA.

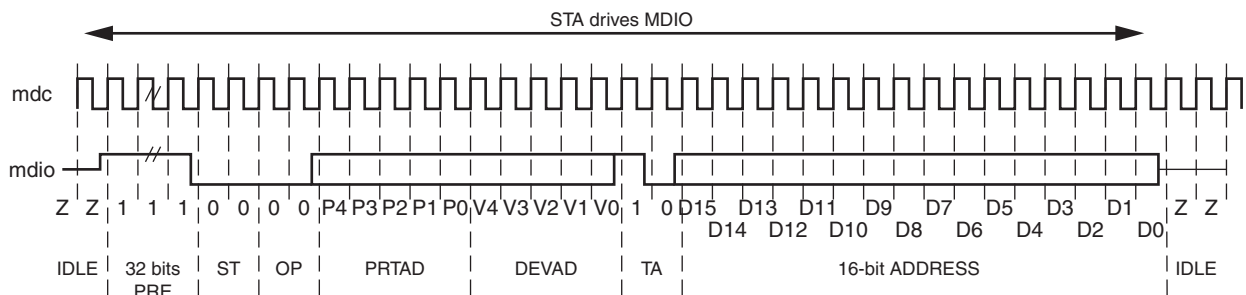

Figure 3-6: MDIO Set Address Transaction

Write Transaction

Figure 3-7 shows a Write transaction defined by OP='01.' The 10GBASE-R/KR core takes the 16-bit word in the data field and writes it to the register at the current address.

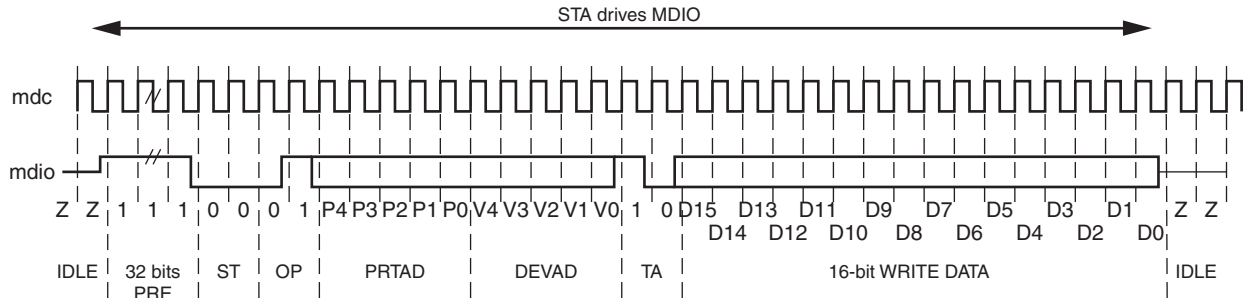

Figure 3-7: MDIO Write Transaction

Read Transaction

Figure 3-8 shows a Read transaction defined by OP='11.' The 10GBASE-R/KR core returns the 16-bit word from the register at the current address.

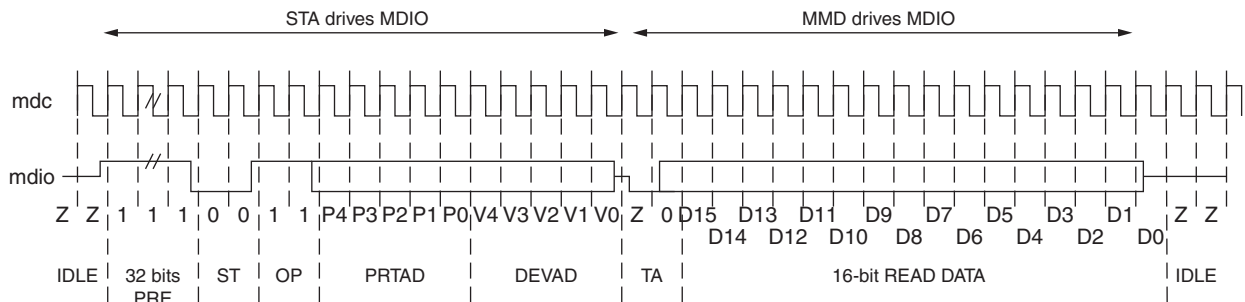

Figure 3-8: MDIO Read Transaction

Post-Read-increment-address Transaction

Figure 3-9 shows a Post-read-increment-address transaction, defined by OP='10.' The 10GBASE-R/KR core returns the 16-bit word from the register at the current address for the given DEVAD then increments that current address. This allows sequential reading or writing by a STA master of a block of contiguous register addresses.

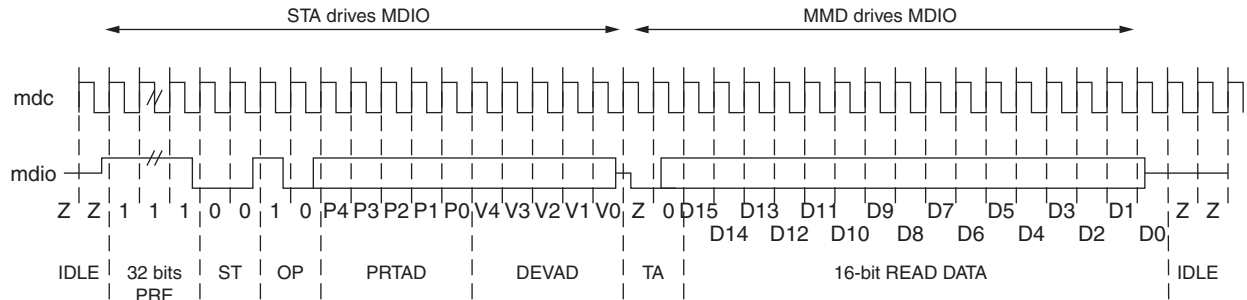

Figure 3-9: MDIO Read-and-increment Transaction

Configuration and Status Vectors

If the 10GBASE-R/KR core is generated without an MDIO interface, the key configuration and status information is carried on simple bit vectors, which are:

- configuration_vector[535:0]
- status_vector[447:0]

These vectors have changed after v1.2 of the core. Legacy-core shims are provided to ensure backward-compatibility.

BASE-R

Table 3-6 shows the breakdown of the 10GBASE-R-specific configuration vector and Table 3-7 shows the breakdown of the status vector. Any bits not mentioned are assumed to be '0's.

Table 3-6: Configuration Vector - BASE-R

Bit	IEEE Register	Description
0	1.0.0	PMA Loopback Enable
15	1.0.15	PMA Reset ⁽¹⁾
16	1.9.0	Global PMD Tx Disable
83:80	1.32788.3:0	PMA Vendor Specific Loopback Mode (HXT only)
110	3.0.14	PCS Loopback Enable
111	3.0.15	PCS Reset ⁽¹⁾
169:112	3.37-3.34	10G PCS Test Pattern Seed A
233:176	3.41-3.38	10G PCS Test Pattern Seed B
240	3.42.0	Data Pattern Select
241	3.42.1	Test Pattern Select
242	3.42.2	Rx Test Pattern Checking Enable
243	3.42.3	TX Test Pattern Enable

Table 3-6: Configuration Vector - BASE-R (Cont'd)

Bit	IEEE Register	Description
244	3.42.4	PRBS31 Tx Test Pattern Enable
245	3.42.5	PRBS31 RX Test Pattern Checking Enable
271:270	3.32768.15:14	PCS Loopback Type (Virtex-6 HXT FPGA only)
399:384	3.65535	125 μ s timer control (Virtex-7/Kintex-7 FPGAs only)
512	(1.1.2) ⁰	Set PMA Link Status
513	(1.8.11:10)	Clear PMA/PMD Link Faults (Virtex-7/Kintex-7 FPGAs only)
516	(3.1.2)	Set PCS Link Status
517	(3.8.11:10)	Clear PCS Link Faults (K7/V7 only)
518	(3.33)	Clear PCS Status 2
519	(3.43)	Clear Test Pattern Error Count

1. These reset signals should be asserted for a single clock tick only.

2. Reset controls for the given registers

Table 3-7: Status Vector - BASE-R

Bit	IEEE Register	Description
15	1.0.15	PMA Reset ⁽²⁾
18	1.1.2	PMA/PMD Rx Link Status (Latching Low) ⁽¹⁾
23	1.1.7	PMA/PMD Fault ⁽²⁾
42	1.8.10	PMA/PMD Rx Fault (Latching High) ⁽²⁾
43	1.8.11	PMA/PMD Tx Fault (Latching High) ⁽²⁾
48	1.10.0	Global PMD RX Signal Detect
207:192	1.65535	Core Info (Virtex-7/Kintex-7 FPGAs only)
223	3.0.15	PCS Reset (Virtex-7/Kintex-7 FPGAs only)
226	3.1.2	PCS Rx Link Status (Latching Low)
231	3.1.7	PCS Fault ⁽¹⁾
250	3.8.10	PCS Rx Fault (Latching High) ⁽²⁾
251	3.8.11	PCS Tx Fault (Latching High) ⁽²⁾
256	3.32.0	10GBASE-R PCS Rx Locked ⁽³⁾
257	3.32.1	10GBASE-R PCS High BER
268	3.32.12	10GBASE-R PCS Rx Link Status ⁽³⁾
279:272	3.33.7:0	10GBASE-R PCS Errored Blocks Counter
285:280	3.33.13:8	10GBASE-R PCS BER Counter
286	3.33.14	Latched High Rx High BER
287	3.33.15	Latched Low Rx Block Lock

Table 3-7: Status Vector - BASE-R (Cont'd)

Bit	IEEE Register	Description
303:228	3.43.15:0	10GBASE-R Test Pattern Error Counter

1. This is tied to '1' for Virtex-6 FPGA BASE-R core.
2. This is tied to '0' for Virtex-6 FPGA BASE-R core.
3. For Virtex-6 devices this signal does not provide an instantaneous status value, but rather the value most recently captured from the equivalent latching register in the GTH transceiver.

BASE-KR

Table 3-8 shows the additional signals in the configuration vector which are specific to BASE-KR functionality.

Table 3-8: Configuration Vector - BASE-KR Specific

Bit	IEEE Register	Description
32	1.150.0	Restart Training
33	1.150.1	Enable Training
53:48	1.152.5:0	LP Training Coefficient Update (valid when 1.150.1 = '0')
60	1.152.12	LP Coefficient Initialize (valid when 1.150.1 = '0')
61	1.152.13	LP Coefficient Preset (valid when 1.150.1 = '0')
64	1.171.0	Enable FEC ⁽¹⁾
65	1.171.1	FEC signal errors to PCS ⁽¹⁾
281	7.0.9	Restart Autonegotiation ⁽²⁾
284	7.0.12	Enable Autonegotiation ⁽²⁾
285	7.0.13	Extended Next Page Support ⁽²⁾
287	7.0.15	Reset Autonegotiation ⁽²⁾
300:293	7.16.12:5	AN Advertisement Data D12..D5
301	7.16.13	AN Advertisement Data - Remote fault
303	7.16.15	AN Advertisement Data - Next Page
319:304	7.17.15:0	AN Advertisement Data - D31..D16
335:320	7.18.15:0	AN Advertisement Data - D47..D32
346:336	7.22.10:0	AN XNP - Message Unformatted Code Field
348	7.22.12	AN XNP Acknowledge 2
349	7.22.13	AN XNP Message Page
351	7.22.15	AN XNP Next Page
367:352	7.23.15:0	AN XNP Unformatted Code Field 1
383:368	7.24.15:0	AN XNP Unformatted Code Field 2
405:400	1.65520.5:0	LD Training Coefficient Update
412	1.65520.12	LD Training Initialize

Table 3-8: Configuration Vector - BASE-KR Specific (Cont'd)

Bit	IEEE Register	Description
413	1.65520.13	LD Training Preset
415	1.65520.15	Training Done
514	(1.173:172)	Clear FEC Corrected Blocks Counter
515	(1.175:174)	Clear FEC Uncorrected Blocks Counter
520	(7.1.2)	Set AN Link Up/Down
521	(7.1.4)	Clear AN Remote Fault
522	(7.1.6)	Clear AN Page Received
523	(7.18:16)	Clear AN Adv Data Valid
524	(7.24:22)	Clear AN XNP Data Valid

1. Only valid when the optional FEC block is included
2. Only valid when the optional AN block is included

Table 3-9 shows the additional signals in the status vector which are specific to BASE-KR functionality.

Table 3-9: Status Vector - BASE-KR Specific

Bit	IEEE Register	Description
67:64	1.151.3:0	PMD Status
85:80	1.153.5:0	LP Status Report Coeff Status
95	1.153.15	LP Status Report Training Complete
101:96	1.152.5:0	LP Coefficient Update
108	1.152.12	LP Coefficient Initialize
109	1.152.13	LP Coefficient Preset
117:112	1.155.5:0	LD Status Report Coefficient Status
127	1.155.15	LD Status Report Training Complete
159:128	1.173:172	FEC Corrected Blocks Count ⁽¹⁾
191:160	1.175:174	FEC Uncorrected Blocks Count ⁽¹⁾
319	7.0.15	AN Reset ⁽²⁾
320	7.1.0	LP AN Capable ⁽²⁾
322	7.1.2	AN Link Up/Down (latching low) ⁽²⁾
323	7.1.3	AN Ability ⁽²⁾
324	7.1.4	AN Remote Fault ⁽²⁾
325	7.1.5	AN Complete ⁽²⁾
326	7.1.6	AN Page Received (latching high) ⁽²⁾
327	7.1.7	AN Extended Next Page Used ⁽²⁾
383:336	7.21:19	AN LP Base Page Ability ⁽²⁾

Table 3-9: Status Vector - BASE-KR Specific (Cont'd)

Bit	IEEE Register	Description
394:384	7.25.10:0	AN LP XNP - Message Unformatted Code Field ⁽²⁾
395	7.25.11	AN LP XNP - Toggle ⁽²⁾
396	7.25.12	AN LP XNP - Acknowledge2 ⁽²⁾
397	7.25.13	AN LP XNP - Message Page ⁽²⁾
399	7.25.15	AN LP XNP - Next Page ⁽²⁾
415:400	7.26.15:0	AN LP XNP - Unformatted Code Field 1 ⁽²⁾
431:416	7.27.15:0	AN LP XNP - Unformatted Code Field 2 ⁽²⁾
432	7.48.0	Backplane AN Ability
435	7.48.3	Backplane Ethernet Status - KR negotiated
436	7.48.4	Backplane Ethernet Status - FEC negotiated

1. Only valid when the optional FEC block is included
2. Only valid when the optional AN block is included

Bit 286 of the Status Vector is latching-high and is cleared low by bit 518 of the configuration_vector port. Figure 3-10 shows how the status bit is cleared.

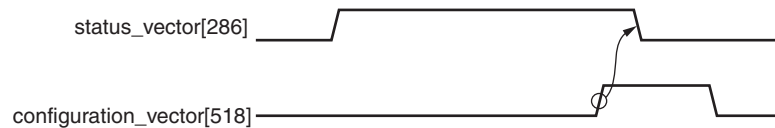

Figure 3-10: Clearing the Latching-High Bits

Bits 18, 226 and 287 of the status_vector port are latching-low and set high by bits 512, 516 and 518 of the configuration vector. Figure 3-11 shows how the status bits are set.

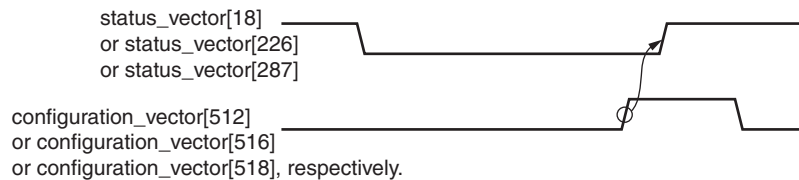

Figure 3-11: Setting the Latching-Low Bits

Similarly for Virtex®-7/Kintex™-7 FPGA designs, Latching High Status Vector bits 42 and 43 can be reset with Configuration Vector bit 513, and bits 250 and 251 can be reset with Configuration Vector bit 517.

Clocking

Virtex-7/Kintex-7 FPGAs

The clocking schemes in this section are illustrative only and can require customization for a specific application.

Reference Clock

For Virtex®-7/Kintex™-7 FPGA transceivers, the reference clock must be running at 156.25 MHz.

Transceiver Placement

A single IBUFDS_GTE2 block is used to feed the reference clocks for all GTXE2_CHANNEL and GTHE2_CHANNEL transceivers, through a GTXE2_COMMON or GTHE2_COMMON block.

For details about Virtex®-7/Kintex™-7 FPGA transceiver clock distribution, see the section on Clocking in the *7 Series Transceivers User Guide* (UG476).

Internal Client-Side Interface

The clocking scheme for the internal client interface is shown in [Figure 3-12](#).

The GTXE2_CHANNEL and GTHE2_CHANNEL primitives require a 156.25 MHz reference clock, as well as 322.26 MHz TX and RX user clocks. The latter must be created from the 322.26 MHz TXOUTCLK and RXOUTCLK outputs from that block.

The 156.25 MHz user-logic clock `c1k156` must be created from the transceiver reference clock to keep the user logic and transceiver interface synchronous.

A dedicated management/configuration clock, `dc1k`, is used by the user logic and the transceiver and must be created from the `c1k156`, at half the rate; that is: 78.125 MHz.

[Figure 3-12](#) shows a possible clocking architecture with a single GTXE2_CHANNEL or GTHE2_CHANNEL block.

The GTH transceiver primitives require a 156.25 MHz clock. The 156.25 MHz clock sourced by the GTH transceiver is used as the clock for the netlist part of the 10GBASE-R/KR core and is typically also used for your logic.

A dedicated management/configuration clock is used by the GTH transceiver tiles. The example design uses a 50 MHz clock. Choosing a different frequency is possible. See *Virtex-6 FPGA GTH Transceivers User Guide* for details about this clock. (UG371).

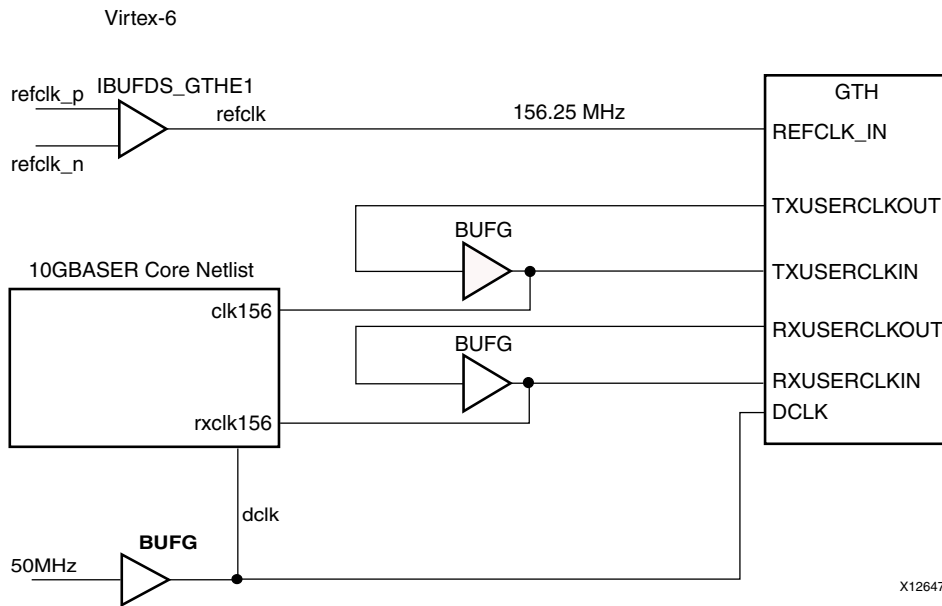

Figure 3-13: Clock Scheme for Internal Client-Side Interface: Virtex-6 HXT FPGAs

Resets

All register resets within the 10GBASE-R/KR core netlist are synchronized to the relevant clock port.

Receiver Termination

Virtex-7/Kintex-7 FPGAs

The receiver termination must be set correctly. See the *7 Series FPGA Transceivers User Guide* (UG476).

Virtex-6 FPGAs

The receiver termination must be set correctly. See *Virtex-6 FPGA GTH Transceivers User Guide* (UG371)

SECTION II: VIVADO DESIGN SUITE

Customizing and Generating the Core

Constraining the Core

Detailed Example Design

Customizing and Generating the Core

This chapter includes information on using Xilinx tools to customize and generate the core using the Vivado™ design tools.

GUI

Figure 4-1 displays the main screen for customizing the 10GBASE-R/KR core.

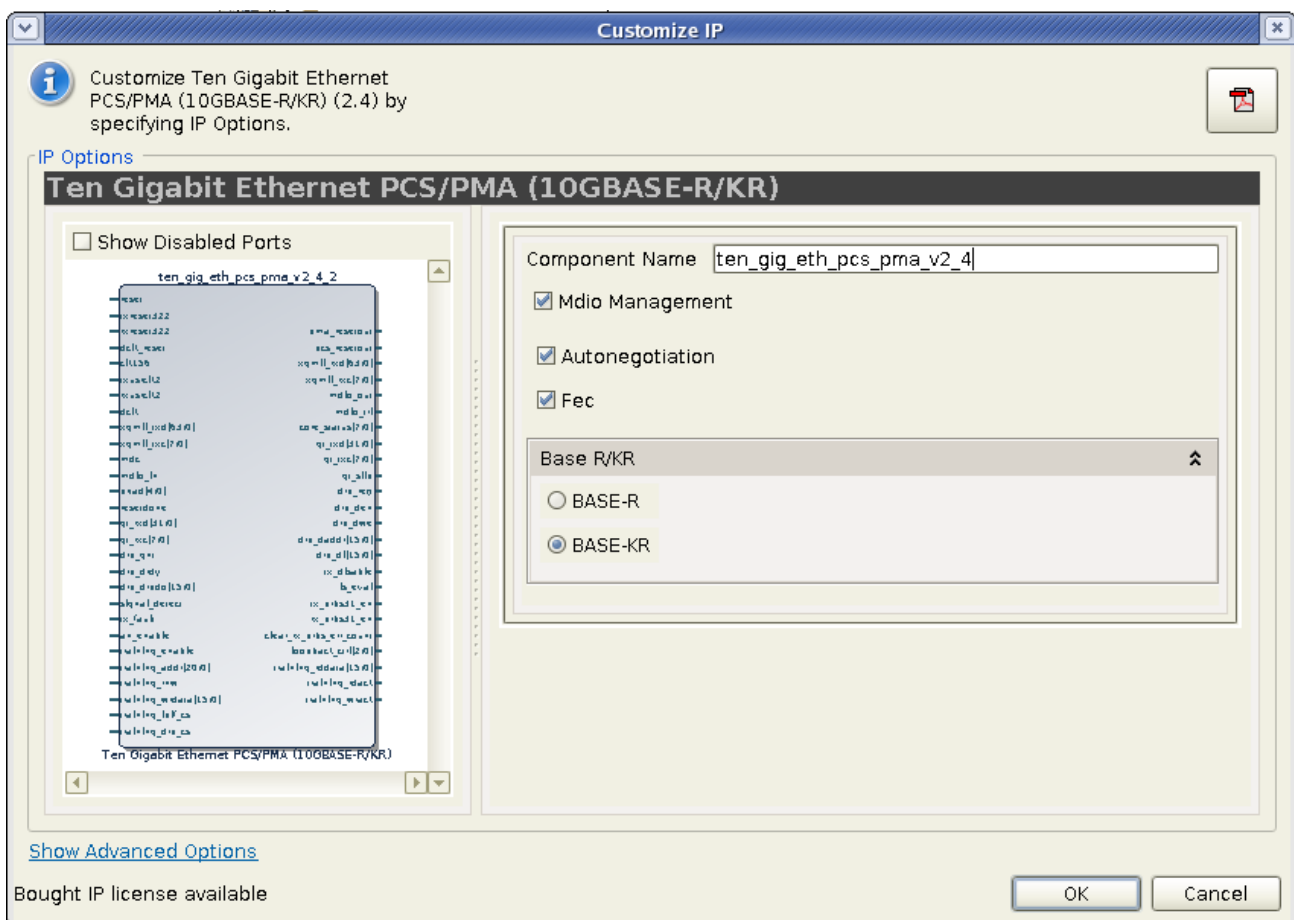

Figure 4-1: Vivado IP Catalog 10GBASE-R/KR Main Screen

Component Name

The component name is used as the base name of the output files generated for the core. Names must begin with a letter and must be composed from the following characters: a through z, 0 through 9 and "_" (underscore).

MDIO Management

Select this option to implement the MDIO interface for managing the core. Deselect the option to remove the MDIO interface and expose a simple bit vector to manage the core.

The default is to implement the MDIO interface.

BASE-R or BASE-KR

Select the Base-KR option to get a Base-KR core and have access to the following two options.

AN Support

Select this option to include the Autonegotiation (AN) block in the Base-KR core.

FEC Support

Select this option to include the FEC block in the Base-KR core.

Output Generation

The core has various selectable output products. These can be generated by right-clicking on the customized piece of IP in the **Sources** window.

- **Examples** - Source HDL and constraints for the example project
- **Simulation** - Simulation source files
- **Synthesis** - Synthesis source files
- **Examples Simulation** - Test bench for the example design
- **Instantiation Template** - Example instantiation template for the core level module.
- **Miscellaneous** - Simulation scripts and support files required for running netlist based functional simulation. The files delivered as part of this filegroup are not used or understood by Vivado tools. These files are delivered into the project source directory.

Constraining the Core

Required Constraints

This section defines the constraint requirements for the core. Constraints are provided in an XDC file which is provided with the HDL example design to give a starting point for constraints for the user design.

The required constraints are shown in the following sections.

Device, Package, and Speed Grade Selections

You are only able to generate the core for supported device, package and speed grade combinations; -1 speed grades are not supported for this core.

Clock Frequencies

The core requires a 156.25 MHz reference clock:

```
create_clock -name Q1_CLK0_GTREFCLK -period 6.400 [get_ports refclk_p]

set clk156name [get_clocks -of_objects [get_pins ten_gig_eth_pcs_pma_block/clkgen_i/CLKOUT0]]
set dclkname [get_clocks -of_objects [get_pins ten_gig_eth_pcs_pma_block/clkgen_i/CLKOUT1]]
```

The transceiver creates 322.26 MHz clocks that must be constrained. These constraints are required for devices with GTXE2 transceivers:

```
create_clock -name RXOUTCLK_OUT -period 3.103 [get_pins -of_objects [get_cells *
-hierarchical -filter {REF_NAME=~ GTXE2_CHANNEL}] -filter {NAME =~ *RXOUTCLK}]
create_clock -name TXOUTCLK_OUT -period 3.103 [get_pins -of_objects [get_cells *
-hierarchical -filter {REF_NAME=~ GTXE2_CHANNEL}] -filter {NAME =~ *TXOUTCLK}]
```

Alternatively, these constraints are required for devices with GTHE2 transceivers:

```
create_clock -name RXOUTCLK_OUT -period 3.103 [get_pins -of_objects [get_cells *
-hierarchical -filter {REF_NAME=~ GTXE2_CHANNEL}] -filter {NAME =~ *RXOUTCLK}]
create_clock -name TXOUTCLK_OUT -period 3.103 [get_pins -of_objects [get_cells *
-hierarchical -filter {REF_NAME=~ GTXE2_CHANNEL}] -filter {NAME =~ *TXOUTCLK}]
```

The following false paths must be declared, because Vivado™ tools consider all clocks related by default.

```
set_multicycle_path 2 -from [all_fanout -flat -endpoints_only -only_cells -from
[get_nets * -hierarchical -filter {NAME =~ *rxusrclk2_en156}]] -to
[all_fanout -flat -endpoints_only -only_cells -from [get_nets * -hierarchical
-filter {NAME =~ *rxusrclk2_en156}]]
set_multicycle_path -hold 1 -from [all_fanout -flat -endpoints_only -only_cells
-from [get_nets * -hierarchical -filter {NAME =~ *rxusrclk2_en156}]] -to [all_fanout
-flat -endpoints_only -only_cells -from [get_nets * -hierarchical -filter
{NAME =~ *rxusrclk2_en156}]]

set_false_path -from [get_clocks RXOUTCLK_OUT] -to [get_clocks Q1_CLK0_GTREFCLK]

set_false_path -from [get_clocks RXOUTCLK_OUT] -to [get_clocks TXOUTCLK_OUT]

set_false_path -from [get_clocks RXOUTCLK_OUT] -to [get_clocks $clk156name]

set_false_path -from [get_clocks RXOUTCLK_OUT] -to [get_clocks $dclkname]

set_false_path -from [get_clocks Q1_CLK0_GTREFCLK] -to [get_clocks TXOUTCLK_OUT]

set_false_path -from [get_clocks Q1_CLK0_GTREFCLK] -to [get_clocks RXOUTCLK_OUT]

set_false_path -from [get_clocks Q1_CLK0_GTREFCLK] -to [get_clocks $clk156name]

set_false_path -from [get_clocks Q1_CLK0_GTREFCLK] -to [get_clocks $dclkname]

set_false_path -from [get_clocks TXOUTCLK_OUT] -to [get_clocks Q1_CLK0_GTREFCLK]

set_false_path -from [get_clocks TXOUTCLK_OUT] -to [get_clocks RXOUTCLK_OUT]

set_false_path -from [get_clocks TXOUTCLK_OUT] -to [get_clocks $clk156name]

set_false_path -from [get_clocks TXOUTCLK_OUT] -to [get_clocks $dclkname]

set_false_path -from [get_clocks $clk156name] -to [get_clocks Q1_CLK0_GTREFCLK]

set_false_path -from [get_clocks $clk156name] -to [get_clocks RXOUTCLK_OUT]

set_false_path -from [get_clocks $clk156name] -to [get_clocks TXOUTCLK_OUT]

set_false_path -from [get_clocks $dclkname] -to [get_clocks Q1_CLK0_GTREFCLK]

set_false_path -from [get_clocks $dclkname] -to [get_clocks RXOUTCLK_OUT]

set_false_path -from [get_clocks $dclkname] -to [get_clocks TXOUTCLK_OUT]

set_false_path -through [get_nets * -hierarchical -filter
{NAME =~ *elastic_buffer_i?can_insert_wra}]
```

These constraints are only required if the optional MDIO interface is not included.

```
set_false_path -from [get_clocks $clk156name] -to [get_ports pcs_loopback]
set_false_path -from [get_ports pcs_loopback] -to [get_clocks $clk156name]
```

The example design contains a DDR register that can be used to forward the XGMII_RX clock off-chip.

```
create_generated_clock -name ddrclk -divide_by 1 -invert -source [get_pins
*rx_clk_ddr/C] [get_ports xgmii_rx_clk]
set_output_delay -max 1.500 -clock ddrclk [get_ports * -filter {NAME =~
*xgmii_rxd*}]
set_output_delay -min -1.500 -clock ddrclk [get_ports * -filter {NAME =~
*xgmii_rxd*}]
set_output_delay -max 1.500 -clock ddrclk [get_ports * -filter {NAME =~
*xgmii_rxc*}]
set_output_delay -min -1.500 -clock ddrclk [get_ports * -filter {NAME =~
*xgmii_rxc*}]
```

Some maximum delay paths must be defined:

```
set_max_delay -through [get_nets * -hierarchical -filter {NAME =~
*elastic_buffer_i*rd_truegray*}] 6.000
set_max_delay -through [get_nets * -hierarchical -filter {NAME =~ **wr_gray**}]
6.000
set_max_delay -through [get_nets * -hierarchical -filter {NAME =~ *rd_lastgray*}]
6.000
```

Clock Management

Any clock management tiles (MMCMs) are exposed in the source code in the example design files for the core, enabling sharing these resources with other cores and designs.

Clock Placement

Location constraints for MMCMs might be required depending on the rest of the system.

Banking

All ports should be given Location constraints appropriate to your design within Banking limits

Transceiver Placement

Transceivers should be given location constraints appropriate to your design.

I/O Standard and Placement

All ports should be given I/O Standard and Location constraints appropriate to your design.

These constraints are required if the optional MDIO interface is included:

```
set_property IOB TRUE [get_cells * -hierarchical -filter {NAME =~ *mdc_reg1*}]
set_property IOB TRUE [get_cells * -hierarchical -filter {NAME =~ *mdio_in_reg1*}]
set_property IOB TRUE [get_cells * -hierarchical -filter {NAME =~ *mdio_out*reg*}]
set_property IOB TRUE [get_cells * -hierarchical -filter {NAME =~ *mdio_tri*reg*}]
```

Detailed Example Design

Example Design

This section shows an example HDL wrapper for Virtex®-7/Kintex™-7 FPGAs.

In [Figure 6-1](#), the example HDL wrapper generated contains the following:

- The block-level instance containing the core, GT_USRCLK_SOURCE and GTWIZARD_10GBASER/GTWIZARD_GTH_10GBASER blocks
- Reset synchronizer registers
- User clock generation
- Double Data Rate (DDR) register on `xgmii_rx_clk`
- 10GBASEKR with no MDIO interface only: Simple Logic to preserve `configuration_vector` and `status_vector` through synthesis to avoid optimizing away logic (because there are not enough I/Os on some devices, to route these signals to and preserve the logic in that way)

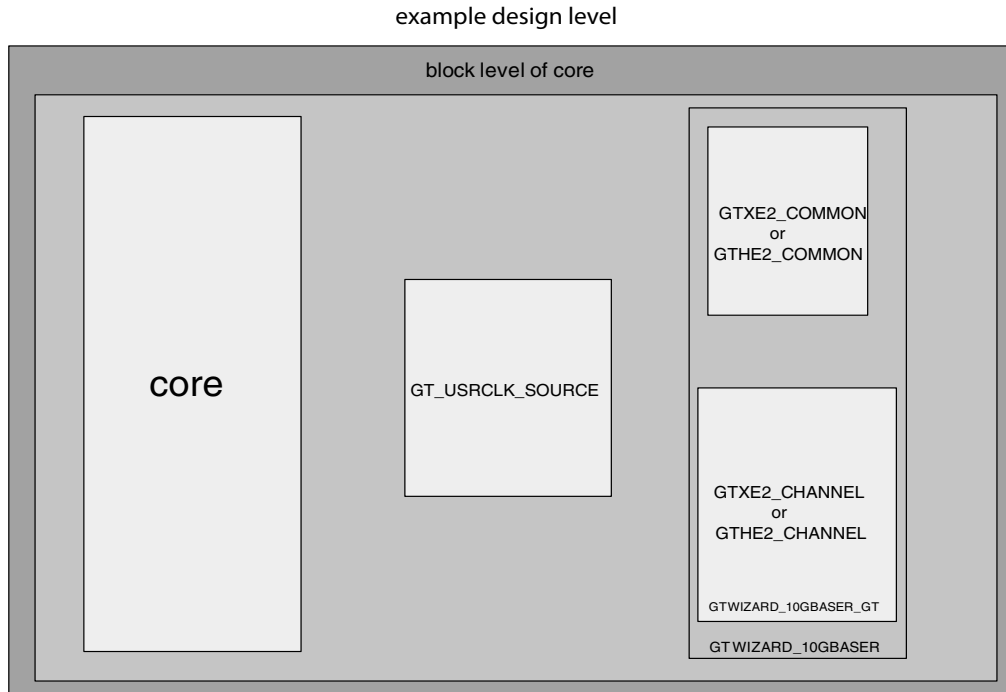

Figure 6-1: Example HDL Wrapper for 10GBASE-R (Virtex-7/Kintex-7 FPGAs)

Demonstration Test Bench

In Figure 6-2, the demonstration test bench is a simple VHDL or Verilog program to exercise the example design and the core itself. This test bench consists of transactor procedures or tasks that connect to the major ports of the example design, and a control program that pushes frames of varying length and content through the design and checks the values as they exit the core. The test bench is supplied as part of the Example Simulation output product group.

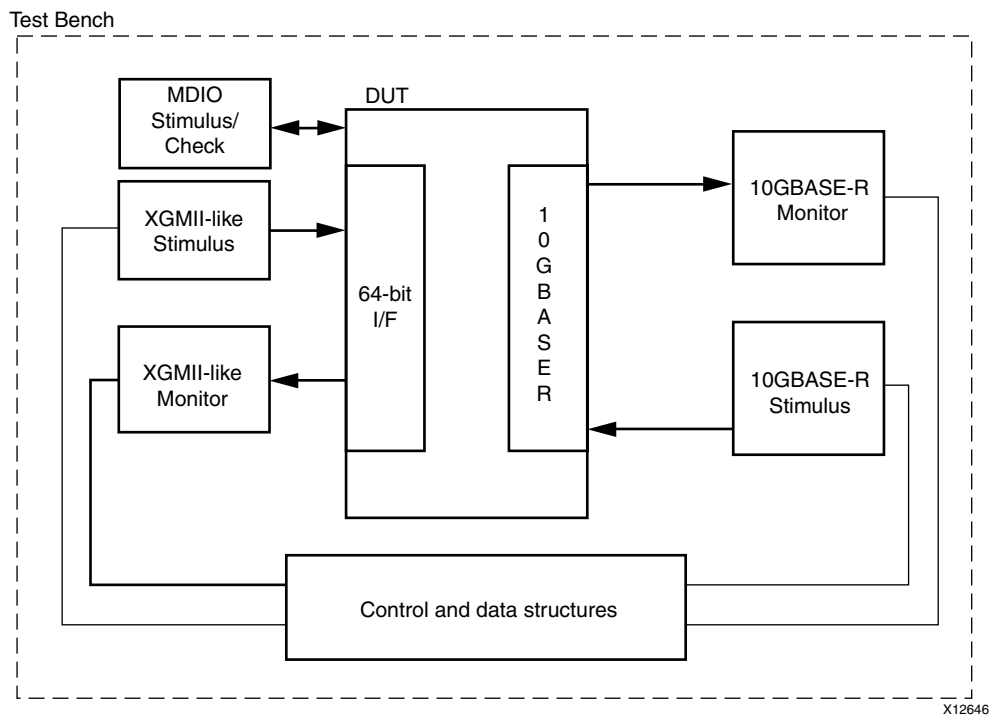

Figure 6-2: Demonstration Test Bench for 10GBASE-R

Implementation

See the [Vivado Design Suite - 2012.2 User Guides web page](#).

Simulation

See the [Vivado Design Suite - 2012.2 User Guides web page](#).

SECTION III: ISE DESIGN SUITE

Customizing and Generating the Core

Constraining the Core

Detailed Example Design

Customizing and Generating the Core

The 10GBASE-R/KR core is generated using the Xilinx CORE Generator™ tool. This chapter describes how to customize the 10GBASE-R/KR core to your requirements and then generate the core netlist.

GUI

Figure 7-1 displays the main screen for customizing the 10GBASE-R/KR core.

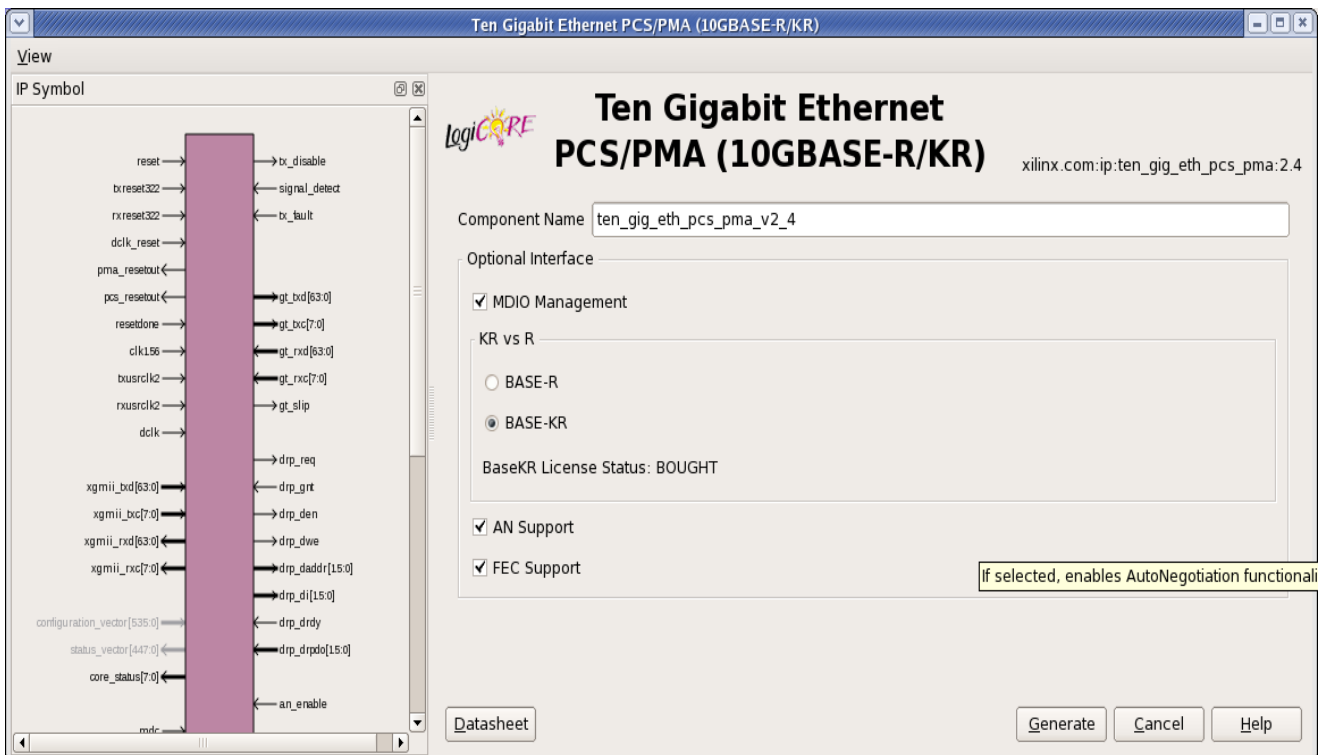

Figure 7-1: 10GBASE-R/KR Main Screen

For general help with starting and using the CORE Generator tool on your development system, see the documentation supplied with the ISE® tools.

Component Name

The component name is used as the base name of the output files generated for the core. Names must begin with a letter and must be composed from the following characters: a through z, 0 through 9 and "_" (underscore).

MDIO Management

Select this option to implement the MDIO interface for managing the core. Deselect the option to remove the MDIO interface and expose a simple bit vector to manage the core.

The default is to implement the MDIO interface.

BASE-R or BASE-KR

Select the Base-KR option to get a Base-KR core and have access to the following two options.

AN Support

Select this option to include the Autonegotiation (AN) block in the Base-KR core.

FEC Support

Select this option to include the FEC block in the Base-KR core.

Parameter Values in the XCO File

Xilinx CORE Generator core source files (XCO) contain parameterization information for an instance of a core; an XCO file is created when a core is generated and can be used to recreate a core. The text in an XCO file is case-insensitive.

Table 7-1 shows the XCO file parameters and values, and summarizes the Graphical User Interface (GUI) defaults. The following is an example extract from an XCO file:

```
# BEGIN Select
SELECT Ten_Gigabit_Ethernet_PCS/PMA_(10GBASE-R/KR)
xilinx.com:ip:ten_gig_eth_pcs_pma:2.4
# END Select
# BEGIN Parameters
CSET autonegotiation=true
CSET base_kr=BASE-KR
CSET component_name=ten_gig_eth_pcs_pma_v2_4
CSET fec=true
CSET mdio_management=true
# END Parameters
```

Table 7-1: XCO File Values and Defaults

Parameter	XCO File Values	Defaults
component_name	ASCII text starting with a letter and based upon the following character set: a...z, 0...9 and _	ten_gig_eth_pcs_pma_v2_4
mdio_management	TRUE, FALSE	TRUE
base_kr ⁽¹⁾	BASE-R, BASE-KR	BASE-KR
fec ⁽²⁾	TRUE, FALSE	TRUE
autonegotiation ⁽²⁾	TRUE, FALSE	TRUE









1. 7 series FPGAs only

2. Base-KR only

Output Generation

The output files generated from the CORE Generator tool are placed in the project directory. The list of output files includes:

- The netlist files for the core
- XCO files
- Release notes and documentation
- Hardware Description Language (HDL) example design
- Scripts to synthesize, implement and simulate the example design.

-  **<project directory>**
 Top-level project directory; name is user-defined
-  **<project directory>/<component name>**
 Core release notes readme file
-  **<component_name>/doc**
 Product documentation
-  **<component_name>/example_design**
 Verilog and VHDL design files
-  **<component name>/implement**
 Implementation script files
-  **implement/results**
 Contains implement script results
-  **<component_name>/simulation**
 Simulation script files
-  **simulation/functional**
 Functional simulation files

<project directory>

The `project` directory contains all the CORE Generator tool project files.

Table 7-2: Project Directory

Name	Description
<project_dir>	
<component_name>.ngc	A binary Xilinx implementation netlist. Describes how the core is to be implemented. Used as an input to the Xilinx implementation tools.
<component_name>.v[hd]	VHDL or Verilog structural simulation model. File used to support functional simulation of a core.
<component_name>.xco	As an output file, the XCO file is a log file which records the settings used to generate a particular core. An XCO file is generated by the CORE Generator tool for each core that it creates in the current project directory. An XCO file can also be used as an input to the CORE Generator tool.
<component_name>_flist.txt	List of files delivered with the core
<component_name>.{veo vho}	A VHDL or Verilog template for the core. This can be copied into your design.

[Back to Top](#)

<project_directory>/<component_name>

The `component_name` directory contains the release notes in the `readme` file provided with the core, which can include tool requirements, updates, and issue resolution.

Table 7-3: Component Name Directory

Name	Description
<project_dir>/<component_name>	
ten_gig_eth_pcs_pma_readme.txt	Core release notes file.

[Back to Top](#)

<component_name>/doc

The `doc` directory contains the PDF documentation provided with the core.

Table 7-4: Doc Directory

Name	Description
<project_dir>/<component_name>/doc	
pg068-ten-gig-eth-pcs-pma.pdf	10GBASER/KR Product Guide

[Back to Top](#)

<component_name>/example_design

The `example_design` directory contains the example design files provided with the core.

Table 7-5: Example Design Directory

Name	Description
<project_dir>/<component_name>/example_design	
<component_name>_block.v[hd]	Block entity containing the 10GBASE-R/KR core and transceiver wrappers.
<component_name>_example_design.v[hd]	Top-level entity for the example design containing the block level design and clocking circuitry.
<component_name>_example_design.ucf ^a	User constraints file for the core and example design.
<component_name>_mod.v	Wrapper file for the 10GBASE-R/KR core.
<component_name>_management_arbiter.v[hd] (Virtex®-6 FPGAs only)	Arbiter for multiple cores accessing GTH_QUAD.
<component_name>_legacy_config_shim.v[hd] (Virtex-6 FPGAs only)	Used to reproduce the original core configuration vector bit numbering.
<component_name>_legacy_status_shim.v[hd] (Virtex-6 FPGAs only)	Used to reproduce the original core status vector bit numbering.

[Back to Top](#)

a. Only generated for BASE-KR cores when an Evaluation or Full license is available

Virtex-7/Kintex-7 FPGAs

Only one of the following directories appears, depending on whether the selected device contains GTXE2 or GTHE2 transceivers.

<component_name>/example_design/gtx

The `gtx` directory contains the example GTX transceiver wrappers which are provided with the core.

Table 7-6: GTX Directory

Name	Description
<p data-bbox="527 657 1195 688" style="text-align: center;"><project_dir>/<component_name>/example_design/gtx</p> <p data-bbox="256 905 834 1037"> <component_name>_gt_usrclk_source.v[hd] <component_name>_gtwizard_10gbaser.v[hd] <component_name>_gtwizard_10gbaser_gt.v[hd] <component_name>_gtwizard_10gbaser.xco </p>	<p data-bbox="963 703 1377 762">Wrappers and support files for the transceivers.</p> <p data-bbox="963 770 1463 888">These can be regenerated from the latest GT_Wizard in the CORE Generator tool, using the 10GBASE-R/KR Protocol and the component name</p> <p data-bbox="963 896 1458 926">'<component_name>_gtwizard_10gbaser'</p> <p data-bbox="963 934 1386 1016">You can use the xco file provided to regenerate the latest version of the transceiver wrappers.</p> <p data-bbox="963 1024 1463 1234">When regenerating the GT_Wizard output, pay close attention to the <code>gt_usrclk_source</code> block generated. This needs to be altered to remove the BUFG for <code>dclk</code> generation because this core requires <code>dclk</code> generation from the reference clock, as illustrated in the example file provided with the core.</p>

[Back to Top](#)

<component_name>/example_design/gth

The `gth` directory contains the example GTH transceiver wrappers which are provided with the core.

Table 7-7: GTH Directory

Name	Description
<project_dir>/<component_name>/example_design/gth	
<p><component_name>_gtwizard_gth_10gbaser_gt_usrclk_source.v[hd] <component_name>_gtwizard_gth_10gbaser.v[hd] <component_name>_gtwizard_gth_10gbaser_gt.v[hd] <component_name>_gtwizard_gth_10gbaser.xco</p>	<p>Wrappers and support files for the transceivers. These can be regenerated from the latest GT_Wizard in the CORE Generator tool, using the 10GBASE-R/KR Protocol and the component name '<code><component_name>_gtwizard_gth_10gbaser</code>' You can use the xco file provided to regenerate the latest version of the transceiver wrappers. When regenerating the GT_Wizard output, pay close attention to the <code>gt_usrclk_source</code> block generated. This needs to be altered to remove the BUFG for <code>dclk</code> generation because this core requires <code>dclk</code> generation from the reference clock, as illustrated in the example file provided with the core.</p>

[Back to Top](#)

Virtex-6 FPGAs

<component_name>/example_design/gth

The `gth` directory contains the example GTH transceiver wrappers which are provided with the core.

Table 7-8: GTH Directory

Name	Description
<project_dir>/<component_name>/example_design/gth	

Table 7-8: GTH Directory (Cont'd)

Name	Description
<component_name>_v6gth_wrapper.v[hd] <component_name>_v6gth_wrapper_quad.v[hd] <component_name>_v6gth_wrapper_gth_init.v[hd] <component_name>_v6gth_wrapper_gth_reset.v[hd] <component_name>_v6gth_wrapper_gth_rx_pcs_cdr_reset.v[hd] <component_name>_v6gth_wrapper_gth_tx_pcs_reset.v[hd] <component_name>_v6gth_wrapper_pulse_synchronizer.v[hd] <component_name>_v6gth_wrapper.xco	Wrappers and support files for the transceivers. These can be (re-)generated at any time from the latest Virtex-6 FPGA GTH Wizard, using '<component_name>_v6gth_wrapper' as the component name. You can use the xco file provided to regenerate the latest version of the GTH transceiver wrappers.

[Back to Top](#)

<component name>/implement

This directory contains the support files necessary for implementation of the example design with the Xilinx tools. Execution of an implement script creates a `results` directory and an `xst` project directory.

Table 7-9: Implement Directory

Name	Description
<project_dir>/<component_name>/implement	
implement.bat	Windows batch file that process the example design through the Xilinx tool flow.
implement.sh	Linux shell script that processes the example design through the Xilinx tool flow.
xst.scr	XST script file for the example design.
xst.prj	XST project file for the example design.

[Back to Top](#)

implement/results

This directory is created by the implement scripts and is used to run the example design files and the <component_name>.ngc file through the Xilinx implementation tools. On completion of an implement script, this directory contains the following files which can be used for timing simulation. Output files from the Xilinx implementation tools can also be found in this directory.

Table 7-10: Results Directory

Name	Description
<project_dir>/<component_name>/implement/results	
routed.v[hd]	The back-annotated SIMPRIM-based VHDL or Verilog design. Can be used for timing simulation.
routed.sdf	Timing information for simulation.

[Back to Top](#)

<component_name>/simulation

The `simulation` directory and the subdirectories below it contain the files necessary to test a VHDL or Verilog implementation of the example design.

Table 7-11: Simulation Directory

Name	Description
<project_dir>/<component_name>/simulation	
demo_tb.v[hd]	The VHDL or Verilog demonstration test bench for the 10GBASE-R/KR core.

[Back to Top](#)

simulation/functional

The `functional` directory contains functional simulation scripts provided with the core.

Table 7-12: Functional Directory

Name	Description
<project_dir>/<component_name>/simulation/functional	
simulate_mti.do	ModelSim macro file that compiles the example design sources, the structural simulation model and the demonstration test bench then runs the functional simulation to completion.
simulate_ncsim.sh	Linux shell script that compiles the example design sources and the structural simulation model then runs the functional simulation to completion using the Cadence Incisive Enterprise Simulator (IES) simulator.
simulate_vcs.sh (verilog only)	Linux shell script that compiles the example design sources and the structural simulation model then runs the functional simulation to completion using Verilog Compiled Simulator (VCS).
ucli_commands.key (verilog only)	VCS command file. This file is called by the <code>simulate_vcs.sh</code> script.
vcs_session.tcl (verilog only)	VCS DVE tcl script that opens wave windows and adds interesting signals to it. This macro is used by the <code>simulate_vcs.sh</code> script.
wave_mti.do	ModelSim macro file that opens a wave window and adds interesting signals to it. This macro is called by the <code>simulate_mti.do</code> macro file.
wave_ncsim.sv	The Cadence IES simulator macro file that opens a wave windows and adds interesting signals to it. This macro is called by the <code>simulate_ncsim.sh</code> script.

[Back to Top](#)

Constraining the Core

This chapter describes how to constrain a design containing the 10GBASE-R/KR core. This is illustrated by the UCF delivered with the core at generation time.

Required Constraints

See [Chapter 9, Detailed Example Design](#), for a complete description of the CORE Generator™ tool output files and for details of the HDL example design.



CAUTION! *Not all constraints are relevant to specific implementations of the core; consult the UCF created with the core instance to see exactly which constraints are relevant.*

Device, Package, and Speed Grade Selections

The following subsections describe device, package, and speed grades for Virtex®-7, Kintex™-7, and Virtex-6 devices.

Virtex-7/Kintex-7 FPGAs

The 10GBASE-R/KR core can be implemented in many Virtex-7/Kintex-7 FPGA packages, as long as the package itself is a flip-chip package, and the GTX/GTH transceiver supports the 10.3125 Gb/s line-rate, which requires speed grades -2, -2L, or -3.

Virtex-6 FPGAs

The 10GBASE-R/KR core can be implemented in most Virtex-6 HXT devices with any speed grade. Only the FF1154 packages are not supported (no bonded-out GTH transceivers)

Clock Frequencies

Virtex-7/Kintex-7 FPGAs

This section specifies the main clock frequencies for the design.

- `txusrclk2` - 322.27 MHz derived from the `txoutclk` output of the Virtex-7/Kintex-7 FPGA transceiver.
- `rxusrclk2` - 322.27 MHz derived from the `rxoutclk` output of the Virtex-7/Kintex-7 FPGA transceiver.
- `dclk` - 78.125 MHz derived from the `clk156` clock. (General Clocking)

Virtex-6 FPGAs

Main Clock Frequencies

This section specifies the main clock frequencies for the design.

```
#####
# Clock frequencies and clock management #
#####
NET "*txuserclkkin" TNM_NET="clk156";
TIMESPEC "TS_clk156" = PERIOD "clk156" 6400 ps;

NET "*rxuserclkkin" TNM_NET="rxclk156";
TIMESPEC "TS_rxclk156" = PERIOD "rxclk156" 6400 ps;
```

The clock frequency by default is set for 10-Gigabit Ethernet.

General Clocking

```
NET "dclk" TNM_NET="dclk";
TIMESPEC TS_dclk = PERIOD "dclk" 50 MHz;
```

This constraint defines the frequency of DCLK that is supplied to the Virtex-6 FPGA transceivers. The example design uses a nominal 50 MHz clock.

Clock Management

Virtex-7/Kintex-7 FPGAs

The 10GBASE-R/KR core has one user clock domain:

- `clk156` - 156.25 MHz derived from the Virtex-7/Kintex-7 FPGA transceiver.

Virtex-6 FPGAs

The 10GBASE-R/KR core has one user clock domain:

- The `clk156` domain derived from the `refclk` input of the Virtex-6 FPGA GTH transceiver.

Clock Placement

Among other constraints you might find in the UCF, the following are required to control the routing between FFs on different clock domains.

```
NET "**elastic_buffer_i*rd_truegray*<?>" MAXDELAY = 6.0 ns;  
NET "**elastic_buffer_i?can_insert_wra" TIG;  
NET "**wr_gray*<?>" MAXDELAY = 6.0 ns;  
NET "**rd_lastgray*<?>" MAXDELAY = 6.0 ns;
```

Banking

Banking limitations might apply to the device selected and so you should take care not to break those limitations.

Transceiver Placement

Virtex-7/Kintex-7 FPGAs

No placement constraints have been introduced for the example design. Consult UG476, *7-Series Transceivers User Guide* for details.

Virtex-6 HXT FPGAs

No placement constraints have been introduced for the example design. Consult UG371, *Virtex-6 FPGA GTH Transceivers User Guide* for details.

I/O Standard and Placement

MDIO

```
#####
# MDIO-related constraints #
#####

INST "ten_gig_eth_pcs_pma_block/ten_gig_eth_pcs_pma_core/BU2/U0/*management_inst/
mdc_reg1" IOB=TRUE;
INST "ten_gig_eth_pcs_pma_block/ten_gig_eth_pcs_pma_core/BU2/U0/*management_inst/
mdio_in_reg1" IOB=TRUE;
INST "ten_gig_eth_pcs_pma_block/ten_gig_eth_pcs_pma_core/BU2/U0/*management_inst/
mdio_interface_1/mdio_out" IOB=TRUE;
INST "ten_gig_eth_pcs_pma_block/ten_gig_eth_pcs_pma_core/BU2/U0/*management_inst/
mdio_interface_1/mdio_tri" IOB=TRUE;
```

These constraints set the correct attributes for the registers at the edge of the MDIO block. The TIMESPEC constrains the MDIO interface to 2.5 MHz. If you wish to overclock the MDIO interface, you must alter this constraint.

Detailed Example Design

This chapter provides detailed information about the example design, including a description of the files and the directory structure generated by the Xilinx CORE Generator™ tool, the purpose and contents of the provided scripts, the contents of the example HDL wrappers, and the operation of the demonstration test bench.

Directory and File Contents

See [Output Generation in Chapter 7](#) for a detailed description of the directories and files.

Example Design

Example HDL Wrapper - Virtex-7/Kintex-7 FPGAs

In [Figure 9-1](#), the example HDL wrapper generated contains the following:

- The block-level instance containing the core, GT_USRCLK_SOURCE and GTWIZARD_10GBASER/GTWIZARD_GTH_10GBASER blocks
- Reset synchronizer registers
- User clock generation
- Double Data Rate (DDR) register on `xgmii_rx_clk`
- 10GBASEKR with no MDIO interface only: Simple Logic to preserve `configuration_vector` and `status_vector` through synthesis to avoid optimizing away logic (because there are not enough I/Os on some devices, to route these signals to and preserve the logic in that way)

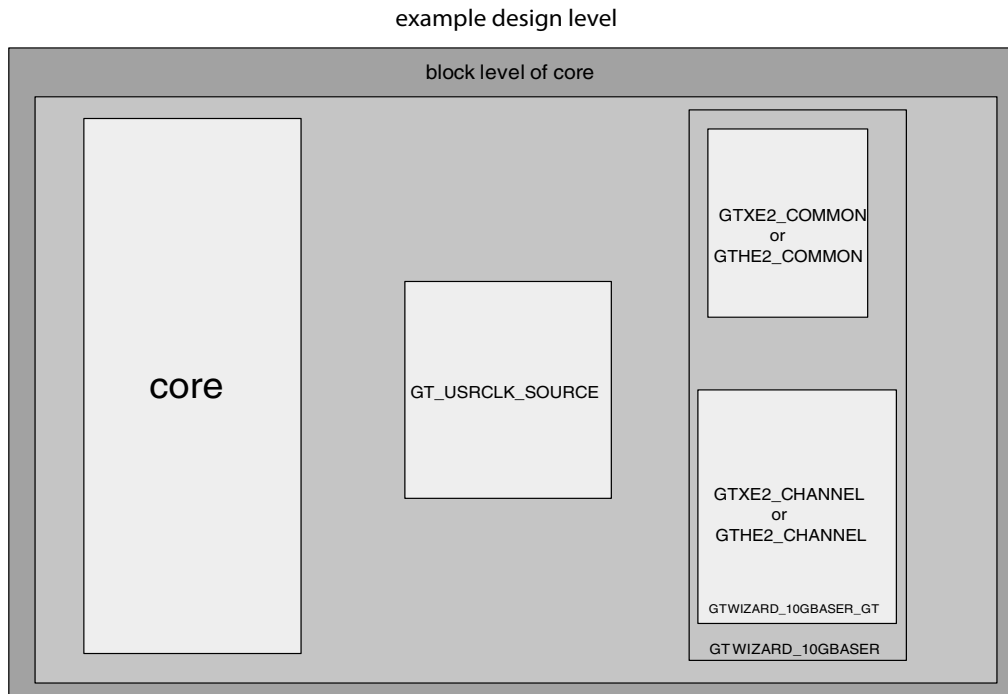

Figure 9-1: Example HDL Wrapper for 10GBASE-R (Virtex-7/Kintex-7 FPGAs)

Example HDL Wrapper (Virtex-6 FPGAs)

In [Figure 9-2](#), the example HDL wrapper generated contains the following:

- The block-level instance containing the core, clock buffers and the transceiver
- Clock Buffer instance for DCLK
- Clock buffer for GTH transceiver reference clock
- DDR register on `xgmii_rx_clk`

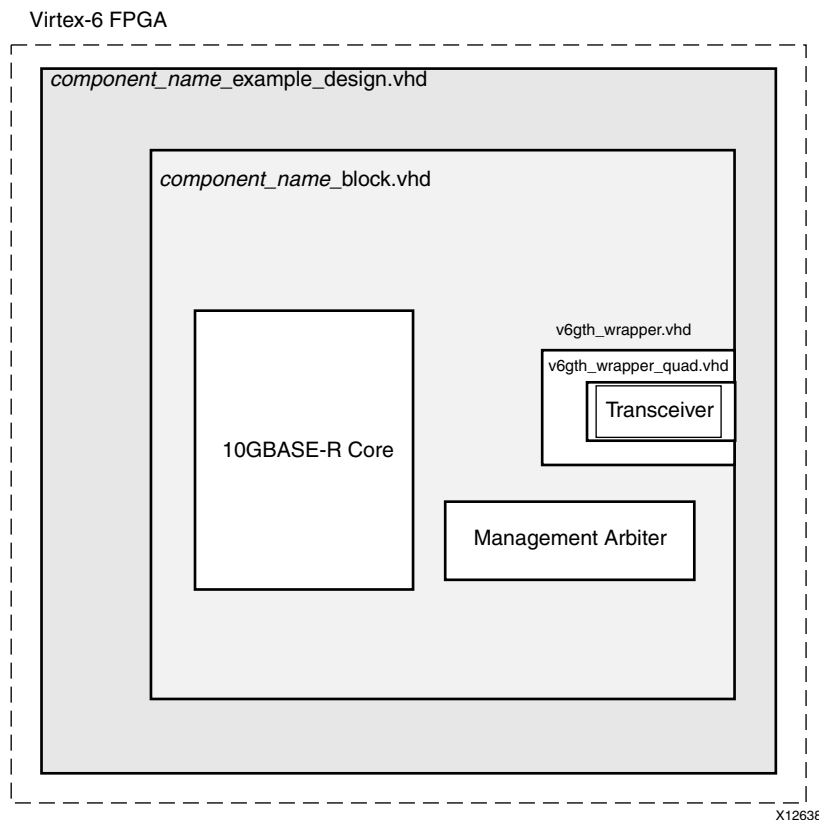

Figure 9-2: Example HDL Wrapper for 10GBASE-R/KR (Virtex-6 FPGAs)

Demonstration Test Bench

In [Figure 9-3](#), the demonstration test bench is a simple VHDL or Verilog program to exercise the example design and the core itself. This test bench consists of transactor procedures or tasks that connect to the major ports of the example design, and a control program that pushes frames of varying length and content through the design and checks the values as they exit the core.

When the DUT is generated without the MDIO interface, a change from the previous version of the core is to only connect the critical parts of the configuration and status vectors to suitably-named I/O signals, in the example design level. Also, for Virtex®-6 FPGA designs, the numbering of bits on the configuration and status vectors has changed from the original release. The rtl files `legacy_config_shim` and `legacy_status_shim` can be used to replicate the original bit numbering.

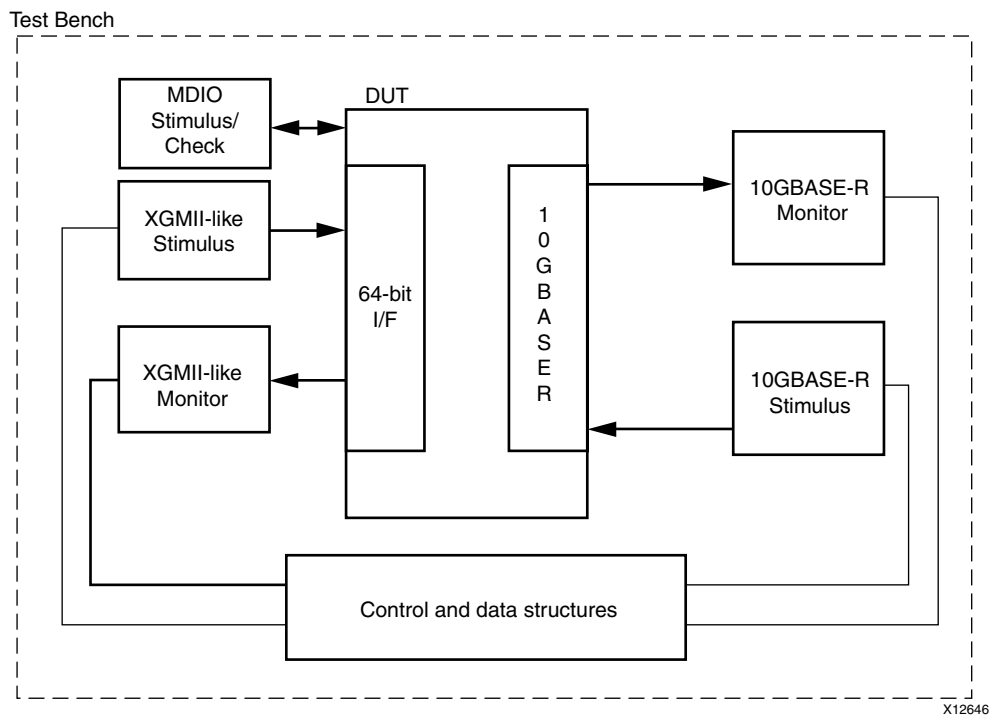

Figure 9-3: Demonstration Test Bench for 10GBASE-R

Implementation

The implementation script is either a shell script or batch file that processes the example design through the Xilinx tool flow. The script is located at:

Linux

```
<project_dir>/<component_name>/implement/implement.sh
```

Windows

```
<project_dir>/<component_name>/implement/implement.bat
```

The implement script performs these steps:

- The example HDL wrapper is synthesized using XST.
- `ngdbuild` is run to consolidate the core netlist and the wrapper netlist into the NGD file containing the entire design.
- The design is mapped to the target technology.
- The design is place-and-routed on the target device.

- Static timing analysis is performed on the routed design using `trce`.
- A bitstream is generated.
- `netgen` runs on the routed design to generate VHDL and Verilog netlists and timing information in the form of SDF files.

Virtex®-7/Kintex™-7 FPGAs: The implement script is only generated for a BASE-KR core when an Evaluation or Full license is available for the core.

Simulation

Setting up for Simulation

The Xilinx UNISIM library must be mapped into the simulator. If the library is not set up for your environment, go to [Answer Record 15338](#) for assistance compiling Xilinx simulation models and for setting up the simulator environment.

All Virtex FPGA designs require a Verilog LRM-IEEE 1364-2005 encryption-compliant simulator. For a Verilog LRM-IEEE 1364-2005 encryption-compliant simulator, the following simulators are supported.

- Mentor Graphics ModelSim version 10.1a
- Cadence Incisive Enterprise Simulator v11.1
- Synopsys VCS and VCS MX 2011.12

Simulation Scripts

Simulation macro files are provided for ModelSim and shell scripts are provided for the Cadence IES simulator and Synopsys VCS simulator. The scripts automate the simulation of the test bench and can be found in the following location:

Functional

```
<project_dir>/<component_name>/simulation/functional/simulate_mti.do  
<project_dir>/<component_name>/simulation/functional/simulate_ncsim.sh  
<project_dir>/<component_name>/simulation/functional/simulate_vcs.sh
```

The scripts perform these tasks:

- Compiles the gate level netlist
- Compiles the demonstration test bench
- Starts a simulation of the test bench
- Opens a Wave window and adds some interesting signals (`wave_mti.do/wave_ncsim.sv/vcs_session.tcl`)
- Runs the simulation to completion

Libraries

The user must ensure that any required simulation support files are created in the simulation/functional directories. These can include library-directory mappings such as those contained in the modelsim.ini file for ModelSim and cds.lib and hdl.var files for IES (NCSIM).

SECTION IV: APPENDICES

Verification, Compliance, and Interoperability

Debugging

Migrating

Special Design Considerations

Additional Resources

Verification, Compliance, and Interoperability

The 10GBASE-R/KR LogiCORE™ IP core has been verified in ISE® 14.2 and Vivado™ 2012.2 design tools with the production Virtex®-6 HXT FPGA and pre-production Virtex-7/Kintex™-7 FPGA speed files. Pre-production means that the speed files are still subject to change. The 10GBASE-R/KR LogiCORE IP core and example design are provided in Verilog and VHDL.

Simulation

A highly parameterizable transaction-based simulation test suite has been used to verify the core. Tests included:

- Register access over MDIO or Configuration/Status vectors
- Loss and re-gain of synchronization
- Loss and re-gain of alignment
- Frame transmission
- Frame reception
- Clock compensation
- Recovery from error conditions
- Autonegotiation phase
- Training phase
- FEC with correctable and uncorrectable errors

Hardware Testing

The 10GBASE-R core has been validated on Virtex-6 devices using a development/demonstration platform on a single development board that includes a 10 Gigabit Ethernet MAC, a processor and data generation and checking hardware, using near-end loopback in PMA, PCS and in optics. Hundreds of millions of Ethernet frames of varying lengths have been successfully transmitted and received on this platform.

The 10GBASE-R and 10GBASE-KR cores have been validated on Kintex-7 devices using the same development/demonstration platform, but on two separate development boards. Again, hundreds of millions of ethernet frames have been successfully transmitted and received on each board and other features such as hot-plugging, autonegotiation and FEC error correction have been tested with the setup.

For 10GBASE-KR, successful, uncorrectable-error-free reception across a backplane emulator of 36inches of '4000 13si' trace on a Nelco Quad Serial Loop (NQSL) board has been demonstrated.

Compliance Testing

The 10GBASE-R core has been validated on Virtex-6 devices at the University of New Hampshire Interoperability Lab.

Debugging

See the [Xilinx Solution Centers](#) for support on devices, software tools, and intellectual property at all stages of the design cycle.

Migrating

See *Vivado Design Suite Migration Methodology Guide* (UG911).

For a complete list of Vivado™ User and Methodology Guides, click [here](#).

Parameter Changes in the XCO File

None

Port Changes

None

Functionality Changes

None

Special Design Considerations

This appendix describes considerations that can apply in particular design cases.

Connecting Multiple Core Instances

The example design provided with the core shows the use of a single core but it is possible to use this and the block level code to create a design with multiple instances of the core.

It is not possible to simply replicate the block level multiple times since much of the clocking and reset logic will be shared between the multiple instances.

Also, multiple transceiver instances can often share the 'COMMON' blocks between them.

When creating a design with multiple core instances, you need to take care to replicate the correct items and not to replicate items which should be shared.

Virtex-7 FPGAs

To instance multiple cores, instantiate those in the 10GBASER/KR block-level component. The `clk156`, `dclk` and `txusrclk2` clocking resources in the block level and `gt_usrclk_source` blocks can be shared between multiple cores, while the `rxusrclk2` resources in the `gt_usrclk_source` block must be replicated for each core.

Replace the `gtwizard_10gbaser` (or `gtwizard_gth_10gbaser` for devices containing GTHE2 transceivers) instance with one with the same name but with up to four transceiver ports exposed (created in the CORE Generator™ tool) and then connect these to the multiple 10GBASER/KR cores and optionally a single MDIO bus.

Also shown in [Figure D-1](#) are several Ten Gigabit Ethernet MAC cores, to illustrate the simplicity of connecting those to the 10GBASE-R/KR cores, to the clock resources and to the MDIO bus. The MDIO 3-state controls are not required for on-chip MDIO connections – connect `mdio_in` on the 10GEMACs to `mdio_out` on the associated 10GBASE-R/KR cores, and vice versa. The 10GEMAC cores supply the MDC clock to the associated 10GBASE-R/KR cores.

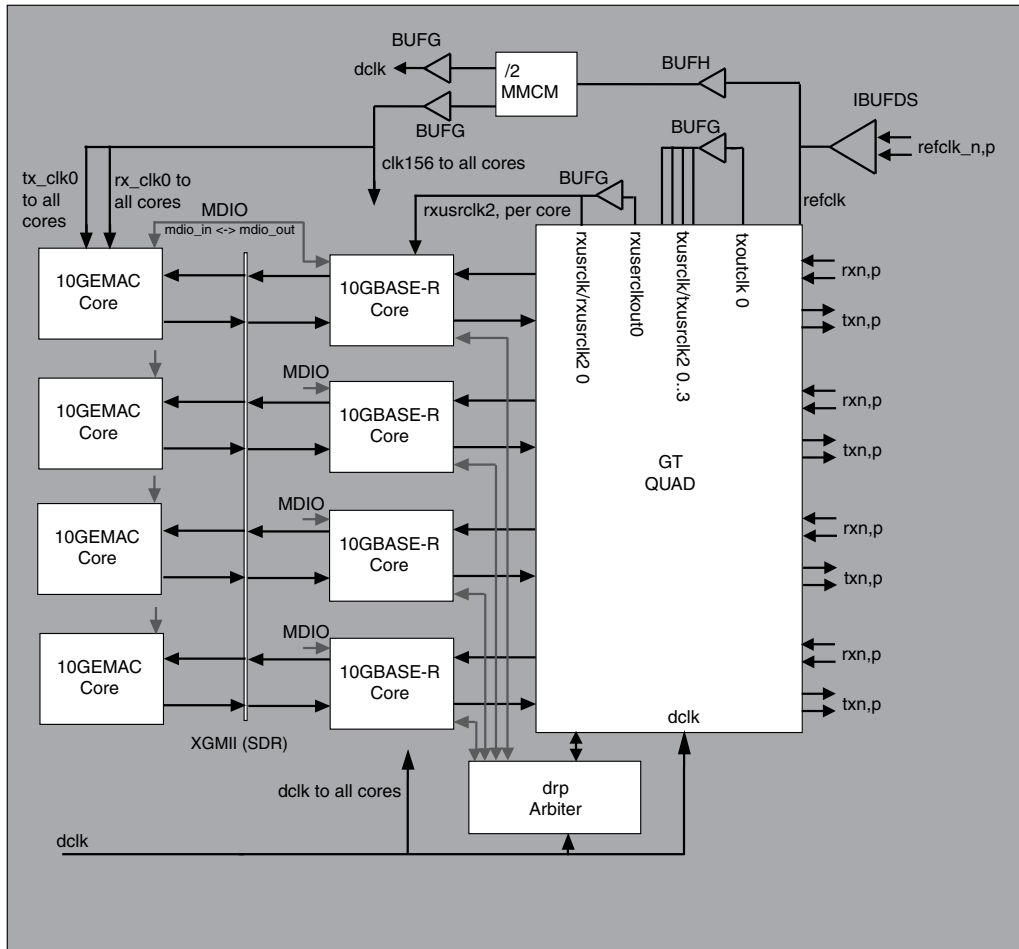

Figure D-1: Attaching Multiple Cores to a GT_QUAD Tile

Virtex-6 HXT FPGAs

To instantiate multiple cores, instantiate those in the 10GBASE-R/KR block-level component, multiple times. The clk156 clocking resources in the block level can be shared between multiple cores, while the rxclk156 resources must appear once for each core.

Replace the v6gth_wrapper by one with the same name but with up to 4 transceiver ports exposed and then connect these to the 10GBASE-R/KR cores and a single management arbiter block.

Also shown in the diagram are several Ten Gigabit Ethernet MAC cores, to illustrate the simplicity of connecting those to the 10GBASE-R/KR cores, to the clock resources and to the MDIO bus. The MDIO 3-state controls are not required for on-chip MDIO connections – connect mdio_in on the 10GEMACs to mdio_out on the associated 10GBASE-R/KR cores, and vice versa. The 10GEMAC cores supply the MDC clock to the associated 10GBASE-R/KR cores.

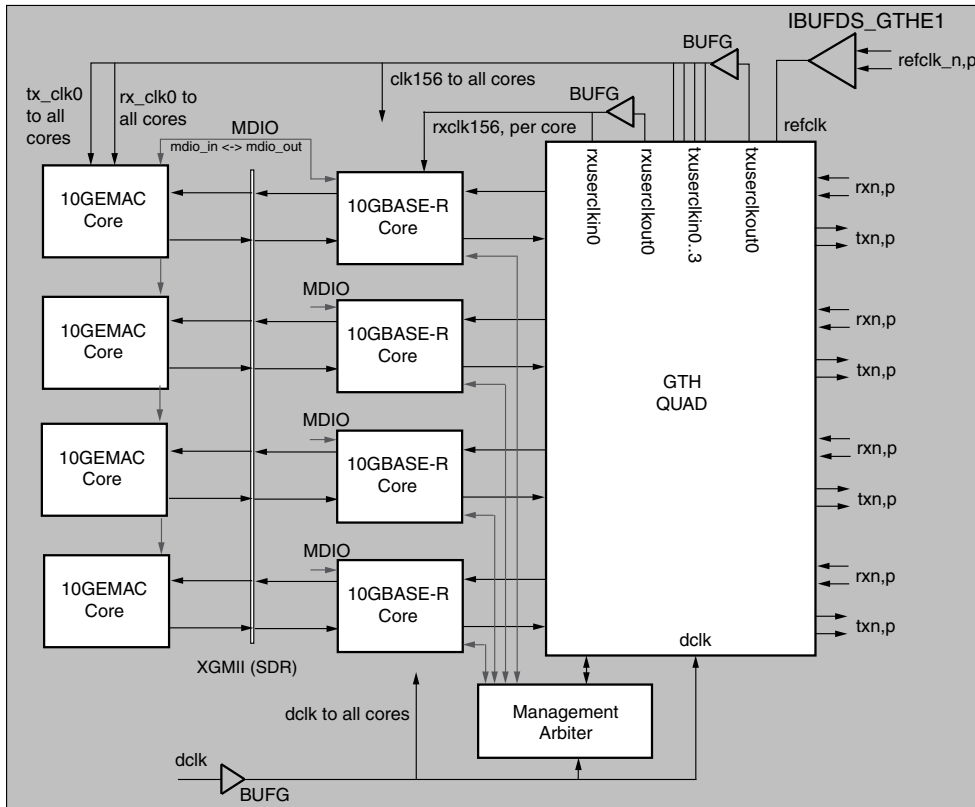

X12652

Figure D-2: Attaching Multiple Cores to a GTH_QUAD Tile

See *Virtex-6 FPGA GTH Transceivers User Guide (UG371)* for details on sharing the reference clock and any limitations.

Using the DRP in Virtex-6 HXT FPGAs

The core, combined with the management arbiter block, accesses the GTH transceiver internal registers through the MGMT interface to the GTH transceiver. To do this, the DRP interface to the GTH transceiver must be disabled. This happens automatically when the core wishes to access those registers.

Access to the DRP is still available to the user, by setting the `drp_req` pin on the management arbiter, and waiting for the `drp_gnt` signal to be asserted before starting any DRP access. This allows any MGMT interface accesses to complete before switching over to the DRP interface and disabling the MGMT interface. The DRP interface is used exclusively until `drp_req` is set low again.

Additional Resources

Xilinx Resources

For support resources such as Answers, Documentation, Downloads, and Forums, see the Xilinx Support website at:

www.xilinx.com/support.

For a glossary of technical terms used in Xilinx documentation, see:

www.xilinx.com/company/terms.htm.

Solution Centers

See the [Xilinx Solution Centers](#) for support on devices, software tools, and intellectual property at all stages of the design cycle. Topics include design assistance, advisories, and troubleshooting tips.

The Solution Center specific to the 10-Gigabit Ethernet PCS/PMA core is located at:

[Xilinx Ethernet IP Solution Center](#)

References

These documents provide supplemental material useful with this product guide:

1. *IEEE Std. 802.3-2008*, Carrier Sense Multiple Access with Collision Detection (CSMA/CD) Access Method and Physical Layer Specifications
2. *IEEE Std. 802.3-2008*, Media Access Control (MAC) Parameters, Physical Layers, and Management Parameters for 10-Gb/s Operation

Technical Support

Xilinx provides technical support at www.xilinx.com/support for this LogiCORE™ IP product when used as described in the product documentation. Xilinx cannot guarantee timing, functionality, or support of product if implemented in devices that are not defined in the documentation, if customized beyond that allowed in the product documentation, or if changes are made to any section of the design labeled DO NOT MODIFY.

See the IP Release Notes Guide ([XTP025](#)) for more information on this core. For each core, there is a master Answer Record that contains the Release Notes and Known Issues list for the core being used. The following information is listed for each version of the core:

- New Features
- Resolved Issues
- Known Issues

Revision History

The following table shows the revision history for this document.

Date	Version	Revision
07/25/12	1.0	Initial Xilinx product guide release. This document is based on ds739 and ug692.

Notice of Disclaimer

The information disclosed to you hereunder (the "Materials") is provided solely for the selection and use of Xilinx products. To the maximum extent permitted by applicable law: (1) Materials are made available "AS IS" and with all faults, Xilinx hereby DISCLAIMS ALL WARRANTIES AND CONDITIONS, EXPRESS, IMPLIED, OR STATUTORY, INCLUDING BUT NOT LIMITED TO WARRANTIES OF MERCHANTABILITY, NON-INFRINGEMENT, OR FITNESS FOR ANY PARTICULAR PURPOSE; and (2) Xilinx shall not be liable (whether in contract or tort, including negligence, or under any other theory of liability) for any loss or damage of any kind or nature related to, arising under, or in connection with, the Materials (including your use of the Materials), including for any direct, indirect, special, incidental, or consequential loss or damage (including loss of data, profits, goodwill, or any type of loss or damage suffered as a result of any action brought by a third party) even if such damage or loss was reasonably foreseeable or Xilinx had been advised of the possibility of the same. Xilinx assumes no obligation to correct any errors contained in the Materials or to notify you of updates to the Materials or to product specifications. You may not reproduce, modify, distribute, or publicly display the Materials without prior written consent. Certain products are subject to the terms and conditions of the Limited Warranties which can be viewed at <http://www.xilinx.com/warranty.htm>; IP cores may be subject to warranty and support terms contained in a license issued to you by Xilinx. Xilinx products are not designed or intended to be fail-safe or for use in any application requiring fail-safe performance; you assume sole risk and liability for use of Xilinx products in Critical Applications: <http://www.xilinx.com/warranty.htm#critapps>.

© Copyright 2012 Xilinx, Inc. Xilinx, the Xilinx logo, Artix, ISE, Kintex, Spartan, Virtex, Vivado, Zynq, and other designated brands included herein are trademarks of Xilinx in the United States and other countries. All other trademarks are the property of their respective owners.