

# **Aurora 64B/66B v11.1**

## ***LogiCORE IP Product Guide***

**Vivado Design Suite**

**PG074 October 5, 2016**

# Table of Contents

## IP Facts

### Chapter 1: Overview

Applications .....	6
Unsupported Features.....	7
Licensing and Ordering Information.....	7

### Chapter 2: Product Specification

Performance.....	9
Resource Utilization.....	11
Port Descriptions .....	11

### Chapter 3: Designing with the Core

General Design Guidelines .....	54
Clocking.....	55
Reset and Power Down .....	58
Shared Logic .....	65
Using CRC .....	67
Hot Plug Logic.....	67
Clock Compensation Logic.....	68
Using Little Endian Support.....	69

### Chapter 4: Design Flow Steps

Customizing and Generating the Core .....	70
Constraining the Core .....	86
Simulation .....	90
Synthesis and Implementation .....	91

### Chapter 5: Example Design

Directory and File Contents.....	92
Quick Start Example Design .....	92
Detailed Example Design.....	94

Using Vivado Lab Tools .....	97
Implementing the Example Design.....	97
Hardware Reset FSM in the Example Design.....	97

**Chapter 6: Test Bench**

**Appendix A: Verification, Compliance, and Interoperability**

**Appendix B: Migrating and Upgrading**

Device Migration .....	104
Upgrading in the Vivado Design Suite .....	105
Migrating Legacy (LocalLink based) Aurora 64B/66B Cores to the AXI4-Stream Aurora 64B/66B Core 107	

**Appendix C: Debugging**

Finding Help on Xilinx.com .....	114
Vivado Design Suite Debug Feature .....	116
Simulation Debug.....	116
Hardware Debug .....	118
Design Bring-Up on the KC705 Evaluation Board .....	124
Interface Debug .....	124

**Appendix D: Generating a GT Wrapper File from the Transceiver Wizard**

**Appendix E: Additional Resources and Legal Notices**

Xilinx Resources .....	126
References .....	126
Revision History .....	127
Please Read: Important Legal Notices .....	131

## Introduction

The Xilinx® LogiCORE™ IP Aurora 64B/66B core is a scalable, lightweight, high data rate, link-layer protocol for high-speed serial communication. The protocol is open and can be implemented using Xilinx device technology.

The Vivado® Design Suite produces source code for Aurora 64B/66B cores. The cores can be simplex or full-duplex, and feature one of two simple user interfaces and optional flow control.

## Features

- Enhanced with a line rate up to 25.7813 Gb/s for GTY transceivers
- General-purpose data channels with throughput range from 500 Mb/s to over 400 Gb/s
- Supports up to 16 consecutively bonded 7 series GTX/GTH, UltraScale™ GTH/GTY or UltraScale+™ GTH/GTY transceivers.
- Aurora 64B/66B protocol specification v1.3 compliant (64B/66B encoding)
- Low resource cost with very low (3%) transmission overhead
- Easy-to-use AXI4-Stream based framing and flow control interfaces
- Automatically initializes and maintains the channel
- Full-duplex or simplex operation
- 32-bit Cyclic Redundancy Check (CRC) for user data
- Added support for the Simplex Auto Link Recovery feature
- Supports RX polarity inversion
- Big endian/little endian AXI4-Stream user interface
- Fully compliant AXI4-Lite DRP interface
- Configurable DRP, INIT clock
- Single/Differential clocking option for GTREFCLK and core INIT\_CLK

LogiCORE IP Facts Table	
Core Specifics	
Supported Device Family <sup>(1)</sup>	UltraScale+™, UltraScale <sup>(2)</sup> , Zynq®-7000 All Programmable SoC Virtex-7 <sup>(3)</sup> , Kintex-7 <sup>(3)</sup>
Supported User Interfaces	AXI4-Stream
Resources <sup>(4)</sup>	<a href="#">Performance and Resource Utilization web page</a>
Provided with Core	
Design Files	register transfer level (RTL)
Example Design	Verilog <sup>(5)</sup>
Test Bench	Verilog
Constraints File	Xilinx Design Constraints (XDC)
Simulation Model	Not Provided
Supported S/W Driver	N/A
Tested Design Flows <sup>(6)</sup>	
Design Entry	Vivado® Design Suite
Simulation	For supported simulators, see the <a href="#">Xilinx Design Tools: Release Notes Guide</a> .
Synthesis	Vivado Synthesis
Support	
Provided by Xilinx at the <a href="#">Xilinx Support web page</a>	

### Notes:

1. For a complete list of supported devices, see the Vivado IP catalog.
2. For more information, see the *Virtex UltraScale FPGAs Data Sheet: DC and AC Switching Characteristics* (DS893) [Ref 1] and *Kintex UltraScale FPGAs Data Sheet: DC and AC Switching Characteristics* (DS892) [Ref 2]
3. For more information, see the *7 Series FPGAs Overview* (DS180) [Ref 3], and the *UltraScale Architecture and Product Overview* (DS890) [Ref 4]
4. For more complete performance data, see [Performance, page 9](#).
5. The core is delivered as open-source code and supports Verilog design environments. Each core comes with an example design and supporting modules.
6. For the supported versions of the tools, see the [Xilinx Design Tools: Release Notes Guide](#).

## Overview

This product guide describes the function and operation of the LogiCORE™ IP Aurora 64B/66B core and provides information about designing, customizing, and implementing the core.

Aurora 64B/66B is a lightweight, serial communications protocol for multi-gigabit links (Figure 1-1). It is used to transfer data between devices using one or many GTX or GTH transceivers. Connections can be *full-duplex* (data in both directions) or *simplex* (data in either one of the directions).

The Aurora 64B/66B core supports the AMBA® protocol AXI4-Stream user interface. It implements the Aurora 64B/66B protocol using the high-speed serial GTX, GTH or GTY transceivers in applicable UltraScale+, UltraScale™, Zynq®-7000, Virtex®-7, and Kintex®-7 devices. A single instance of Aurora 64B/66B core can use up to 16 valid consecutive lanes on GTX,GTH or GTY transceivers running at any supported line rate to provide a low-cost, general-purpose, data channel with throughput from 500 Mb/s to over 400 Gb/s.

Aurora 64B/66B cores are verified for protocol compliance using an array of automated simulation tests.

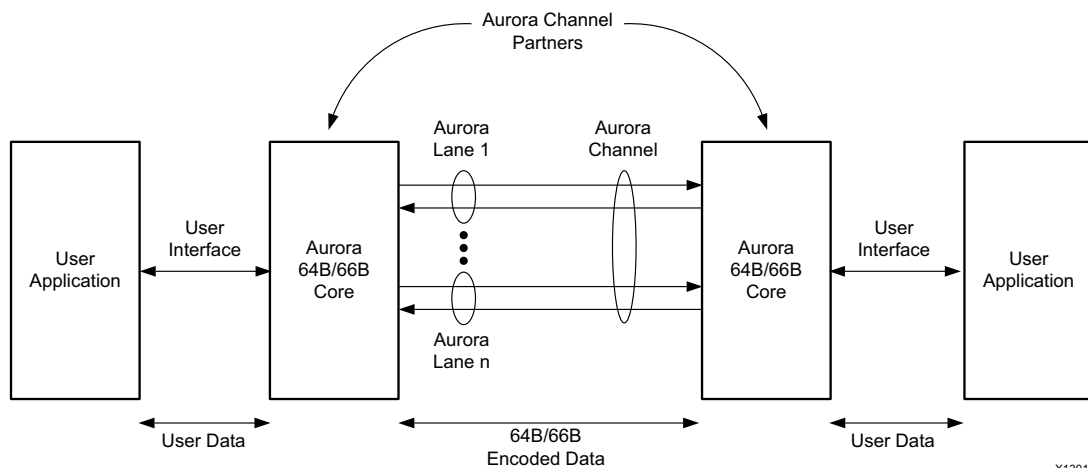

Figure 1-1: Aurora 64B/66B Channel Overview

X13011

Aurora 64B/66B cores automatically initialize a channel when they are connected to an Aurora 64B/66B channel partner. After initialization, applications can pass data across the channel as *frames* or *streams* of data. Aurora 64B/66B *frames* can be of any size, and can be interrupted any time by high priority requests. Gaps between valid data bytes are automatically filled with *idles* to maintain lock and prevent excessive electromagnetic interference. *Flow control* is optional in Aurora 64B/66B, and can be used to throttle the link partner transmit data rate, or to send brief, high-priority messages through the channel.

*Streams* are implemented in Aurora 64B/66B as a single, unending frame. Whenever data is not being transmitted, idles are transmitted to keep the link alive. Excessive bit errors, disconnections, or equipment failures cause the core to reset and attempt to initialize a new channel. The Aurora 64B/66B core can support a maximum of two symbols skew in the receipt of a multi-lane channel. The Aurora 64B/66B protocol uses 64B/66B encoding. The 64B/66B encoding offers theoretical improved performance because of its very low (3%) transmission overhead, compared to 25% overhead for 8B/10B encoding.



**RECOMMENDED:**

1. *Although the Aurora 64B/66B core is a fully-verified solution, the challenge associated with implementing a complete design varies depending on the configuration and functionality of the application. For best results, prior experience in building high-performance, pipelined FPGA designs using Xilinx implementation tools and Xilinx® Design Constraints (XDC) user constraints files is recommended.*
2. *Consult the PCB design requirements information in the UltraScale FPGAs GTH Transceivers User Guide (UG576) [Ref 5], UltraScale FPGAs GTY Transceivers User Guide (UG578) [Ref 6], and 7 Series FPGAs GTX/GTH Transceivers User Guide (UG476) [Ref 7]. Contact your local Xilinx representative for a closer review and estimation for your specific requirements.*

## Applications

Aurora 64B/66B cores can be used in a wide variety of applications because of their low resource cost, scalable throughput, and flexible data interface. Examples of Aurora 64B/66B core applications include:

- **Chip-to-chip links:** Replacing parallel connections between chips with high-speed serial connections can significantly reduce the number of traces and layers required on a PCB.
- **Board-to-board and backplane links:** Aurora 64B/66B uses standard 64B/66B encoding, which is the preferred encoding scheme for 10 Gigabit Ethernet, making it compatible with many existing hardware standards for cables and backplanes. Aurora 64B/66B can be scaled, both in line rate and channel width, to allow inexpensive legacy hardware to be used in new, high-performance systems.

- **Simplex connections (unidirectional):** The Aurora 64B/66B simplex protocol provides unidirectional channel initialization, making it possible to use the GTX, GTH and GTY transceivers when a back channel is not available, and to reduce costs due to unused full-duplex resources.

---

## Unsupported Features

AXI4-Stream non-strict aligned mode is not supported in the Aurora 64B/66B core. GTP and GTZ type transceivers of 7 series devices are not supported in the Aurora 64B/66B core. Aurora 64B/66B supports UFC feature only in GTYE3/GTYE4 devices up to 16.375G.

---

## Licensing and Ordering Information

This Xilinx LogiCORE IP module is provided at no additional cost with the Xilinx Vivado® Design Suite under the terms of the [Xilinx End User License](#). Information about this and other Xilinx LogiCORE IP modules is available at the [Xilinx Intellectual Property](#) page. For information about pricing and availability of other Xilinx LogiCORE IP modules and tools, contact your [local Xilinx sales representative](#).

For more information, visit the [Aurora 64B/66B product page](#).

# Product Specification

Figure 2-1 shows a block diagram of the Aurora 64B/66B core.

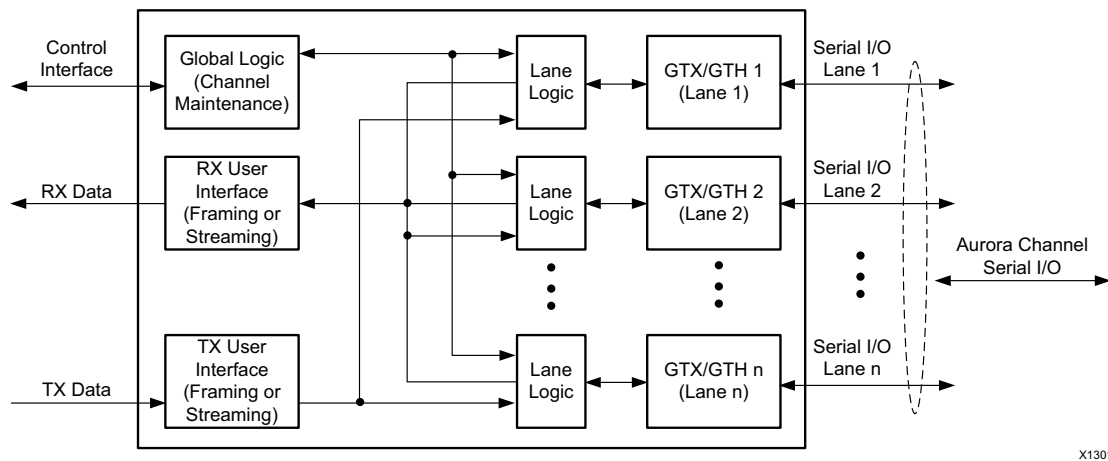

Figure 2-1: Aurora 64B/66B Core Block Diagram

The major functional modules of the Aurora 64B/66B core are:

- **Lane logic:** Each GTX and GTH transceiver is driven by an instance of the lane logic module which initializes each individual transceiver, handles the encoding and decoding of control characters, and performs error detection.
- **Global logic:** The global logic module in the core performs the channel bonding for channel initialization. During operation, the channel keeps track of the Not Ready idle characters defined by the Aurora 64B/66B protocol and monitors all the lane logic modules for errors.
- **RX user interface:** The AXI4-Stream receive (RX) user interface moves data from the channel to the application and also performs flow control functions.
- **TX user interface:** The AXI4-Stream transmit (TX) user interface moves data from the application to the channel and also performs flow control TX functions. The standard clock compensation module is embedded inside the core. This module controls periodic transmission of the clock compensation (CC) character.



## Performance

This section details the performance information for various core configurations.

### Maximum Frequencies

The maximum frequency of the core operation is dependent on the line rates supported and the speed grade of the devices.

### Latency

For a default single lane configuration, latency through an Aurora 64B/66B core is caused by pipeline delays through the protocol engine (PE) and through the GTX and GTH transceivers. The PE pipeline delay increases as the AXI4-Stream interface width increases. The transceiver delays are determined by the transceiver features.

This section outlines a method of measuring the latency for the Aurora 64B/66B core AXI4-Stream user interface in terms of `user_clk` cycles for UltraScale™, Zynq®-7000, Virtex®-7, and Kintex®-7 device GTX, GTH and GTY transceiver-based designs. For the purposes of illustrating latency, the Aurora 64B/66B modules are partitioned between logic in the GTX and GTH transceivers and protocol engine (PE) logic implemented in the FPGA.

Figure 2-2 illustrates the latency of the datapath.

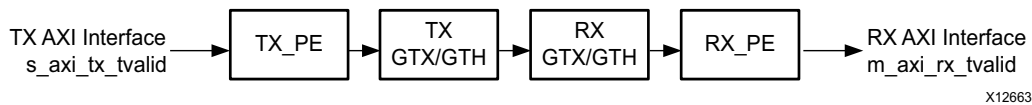
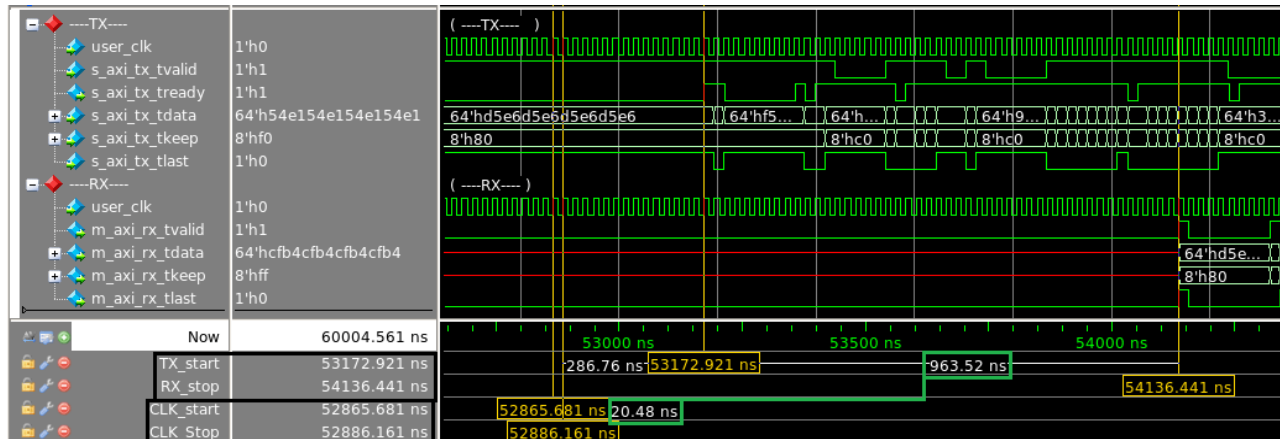

Figure 2-2: Latency of the Datapath

**Note:** Figure 2-2 does not include the latency incurred due to the length of the serial connection between each side of the Aurora 64B/66B channel.

The latency must be measured from the rising edge of the transmitter `user_clk` at the first assertion of `s_axi_tx_tvalid` and `s_axi_tx_tready` to the rising edge of the receiver `user_clk` at the first assertion of `m_axi_rx_tvalid`. **Figure 2-3** shows the transmitter and receiver path reference points between which the latency has been measured for the default core configuration.



**Figure 2-3: Latency Waveform with Reference Points**

**Table 2-1** shows the maximum latency and the individual latency values of the contributing pipeline components for the default core configuration on 7 series GTX, GTH and UltraScale GTH transceiver based devices. Latency can vary with the addition of flow controls.

**Table 2-1: Latency for the Default Aurora 64B/66B Core Configuration**

Latency Component	user_clk Cycles
Logic	46
Gearbox	1 or 2
Clock Compensation	7
Maximum (total)	54 or 55

The pipeline delays are designed to maintain the clock speed.

## Throughput

Aurora 64B/66B core throughput depends on the number of the transceivers and the target line rate of the transceivers selected. For GTH transceivers, the throughput varies from 0.48 Gb/s to 254.06 Gb/s for a single-lane design to a 16-lane design, respectively. The throughput was calculated using 3% overhead of Aurora 64B/66B protocol encoding and 0.5 Gb/s to 16.375 Gb/s line rate range. For GTY transceivers, the throughput varies from 0.455 Gb/s to 399.99 Gb/s with the supported line rate range of 0.5 Gb/s to 25.7813 Gb/s. The GTY transceiver transmission has approximately 8% to 9% overhead.

**Note:** Line rate value is restricted to four decimal digits for UltraScale with the exception of 25.78125 Gb/s for GTY devices.

## Resource Utilization

For full details about performance and resource utilization, visit the [Performance and Resource Utilization web page](#).

**Note:** UltraScale+ and UltraScale™ device utilization results are expected to be similar to 7 series devices.

## Port Descriptions

The parameters used to generate each Aurora 64B/66B core determine the interfaces available for that specific core. USER\_DATA\_S\_AXIS\_TX is an interface and the `s_axi_tx_*` ports are grouped into that interface. The interfaces are visible in the IP symbol as seen in [Figure 2-4](#). One can see the ports grouped in it. In this section, in general, the interface appears as a single row entry followed by the ports which are grouped in an interface by clicking on the + sign beside the interface. Aurora 64B/66B cores can have four to eight interfaces. [Figure 2-4](#) shows the Aurora 64B/66B IP symbol for the default core configuration with all flow control options and CRC enabled.

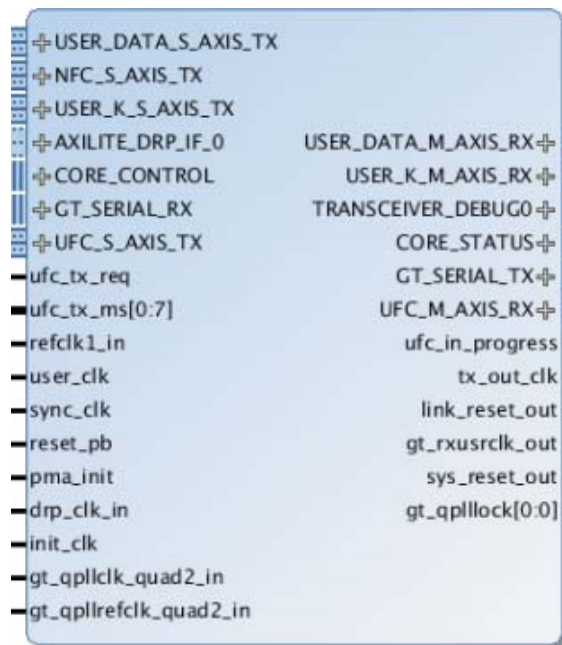

Figure 2-4: Aurora 64B/66B IP Symbol

## User Interface

The Aurora 64B/66B core can be generated with either a framing or streaming user data interface. Data port width depends on the number of lanes selected. Table 2-2 lists simplex/duplex port descriptions for the AXI4-Stream TX data ports.

Table 2-2: User Interface Ports

Name	Direction	Clock Domain	Description
<b>USER_DATA_S_AXIS_TX</b>			
s_axi_tx_tdata[0:(64n-1)] or s_axi_tx_tdata[(64n-1):0] <sup>(1)(2)</sup>	Input	user_clk	Outgoing data (ascending bit order).
s_axi_tx_tready <sup>(2)</sup>	Output	user_clk	Asserted when signals from the source are accepted. Deasserted when signals from the source are ignored.
s_axi_tx_tvalid <sup>(2)</sup>	Input	user_clk	Asserted when AXI4-Stream signals from the source are valid. Deasserted when AXI4-Stream control signals and/or data from the source should be ignored.
s_axi_tx_tlast <sup>(2)</sup>	Input	user_clk	Indicates the end of the frame. <i>This port is not available if the Streaming interface option is chosen.</i>
s_axi_tx_tkeep[0:(8n-1)] or s_axi_tx_tkeep[(8n-1):0] <sup>(1)(2)</sup>	Input	user_clk	Specifies the number of valid bytes in the last data beat (number of valid bytes = number of 1s in tkeep). s_axi_tx_tkeep is sampled only when s_axi_tx_tlast is asserted. The core supports continuous aligned and continuous unaligned data streams and expects data to be filled continuously from LSB to MSB. There cannot be invalid bytes interleaved with the valid s_axi_tx_tdata bus. <i>This port is not available if the Streaming interface option is chosen.</i>
<b>USER_DATA_M_AXIS_RX</b>			
m_axi_rx_tdata[0:(64n-1)] or m_axi_rx_tdata[(64n-1):0] <sup>(1)(3)</sup>	Output	user_clk	Incoming data from channel partner (ascending bit order).
m_axi_rx_tvalid <sup>(3)</sup>	Output	user_clk	Asserted when data from core is valid. Deasserted when data from the core should be ignored.
m_axi_rx_tlast <sup>(3)</sup>	Output	user_clk	Indicates the end of the incoming frame. <i>This port is not available if the Streaming interface option is chosen.</i>

**Table 2-2: User Interface Ports (Cont'd)**

Name	Direction	Clock Domain	Description
m_axi_rx_tkeep[0:(8n-1)] or m_axi_rx_tkeep[(8n-1):0] <sup>(1)(3)</sup>	Output	user_clk	Specifies the number of valid bytes in the last data beat. <i>This port is not available if the Streaming interface option is chosen.</i>

**Notes:**

1. *n* is the number of lanes.
2. This port is not available in RX-only simplex mode.
3. This port is not available in TX-only simplex mode

**Top-Level Interface**

The Aurora 64B/66B top-level (block level) file contains the top-level interface definition and is the starting point for a user design. The top-level file instantiates the Aurora 64B/66B lane module, the TX and RX AXI4-Stream modules, the global logic module, and the GTX, GTH or GTY transceiver wrapper. This top-level wrapper file is instantiated in the example design file together with the clock, reset circuit, and frame generator and checker modules.

Figure 2-5 shows the Aurora 64B/66B top level for a duplex configuration.

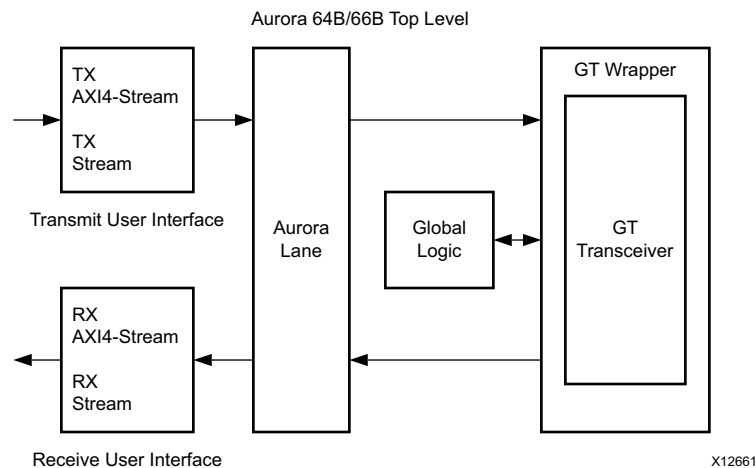

**Figure 2-5: Aurora 64B/66B Duplex Top-Level Architecture**

The timing requirements for the streaming and framing interfaces are described in [Framing Interface](#) and [Streaming Interface](#).

Figure 2-6 shows an  $n$ -byte example of the Aurora 64B/66B AXI4-Stream data interface bit ordering.

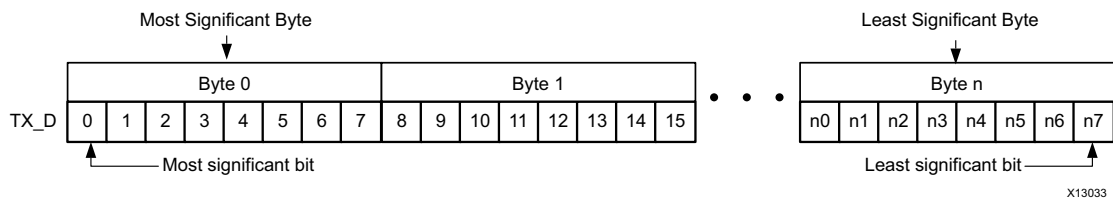

Figure 2-6: AXI4-Stream Interface Bit Ordering

### Framing Interface

The framing user interface (Figure 2-7) complies with the *AXI4-Stream Protocol Specification [Ref 8]* and comprises the signals necessary for transmitting and receiving framed user data. A detailed description of the framing interface follows.

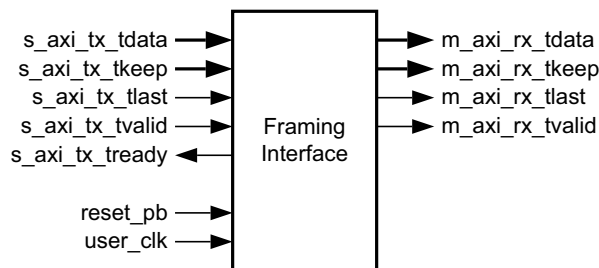

Figure 2-7: Aurora 64B/66B Framing User Interface (AXI4-Stream)

### Transmitting Data

The Aurora 64B/66B core samples the data only if both `s_axi_tx_tready` and `s_axi_tx_tvalid` are asserted. The user application can deassert `s_axi_tx_tvalid` on any clock cycle (Figure 2-9, page 17) to ignore the AXI4-Stream input for that cycle. If this occurs in the middle of a frame, idle symbols are sent through the Aurora 64B/66B channel.

The AXI4-Stream data is only valid when it is framed. Data outside of a frame is ignored. To end a frame, assert `s_axi_tx_tlast` while the last word (or partial word) of data is on the `s_axi_tx_tdata` port and use `s_axi_tx_tkeep` to specify the number of valid bytes in the last data beat.

High priority is assigned to these requests for any type of transfer:

- TXDATAVALID deasserted from the transceiver TX interface (1 cycle)
- CC transmission (8 cycles)

### Aurora 64B/66B Frames

All Aurora 64B/66B data is sent as part of a data block or a separator block. A separator block (SEP) consists of a count field indicating how many bytes are valid in that particular block. In framing, each frame begins with data blocks and ends with a separator block containing the last bytes of the frame. Idle blocks are inserted whenever data is not available. Blocks are eight bytes of scrambled data or control information with a two-bit control header (a total of 66 bits).

Table 2-3 shows a typical Aurora 64B/66B frame with an even number of data bytes.

Table 2-3: Typical Channel Frame

Data Byte 0	Data Byte 1	Data Byte 2	Data Byte 3	...	Data Byte $n-2$	Data Byte $n-1$	Data Byte $n$
SEP (1E)	Count (4)	Data Byte 0	Data Byte 1	Data Byte 2	Data Byte 3	x	x

To transmit data, the user application configures the control signals causing the core to perform these steps:

1. Accept data from the user application on the `s_axi_tx_tdata` bus.
2. Indicate the end of frame when `s_axi_tx_tlast` is asserted along with `s_axi_tx_tkeep` and stripe data across lanes in the Aurora 64B/66B channel.
3. Insert idle or pause cycles on the serial line when the user application deasserts `s_axi_tx_tvalid`.

When the core receives data, it performs these steps:

1. Detects and discards control bytes (idles, clock compensation).
2. Recovers data from the lanes.
3. Assembles data for presentation to the user application on the `m_axi_rx_tdata` bus including providing the number of valid bytes on `m_axi_rx_tkeep` and asserts `m_axi_rx_tvalid` during the `m_axi_rx_tlast` cycle.

**Example A: Simple Data Transfer**

Figure 2-8 shows an example of a simple  $n$  byte wide data transfer.  $3n$  bytes of data are sent requiring three data beats. `s_axi_tx_tready` is asserted indicating that the AXI4-Stream interface is ready to transmit data.

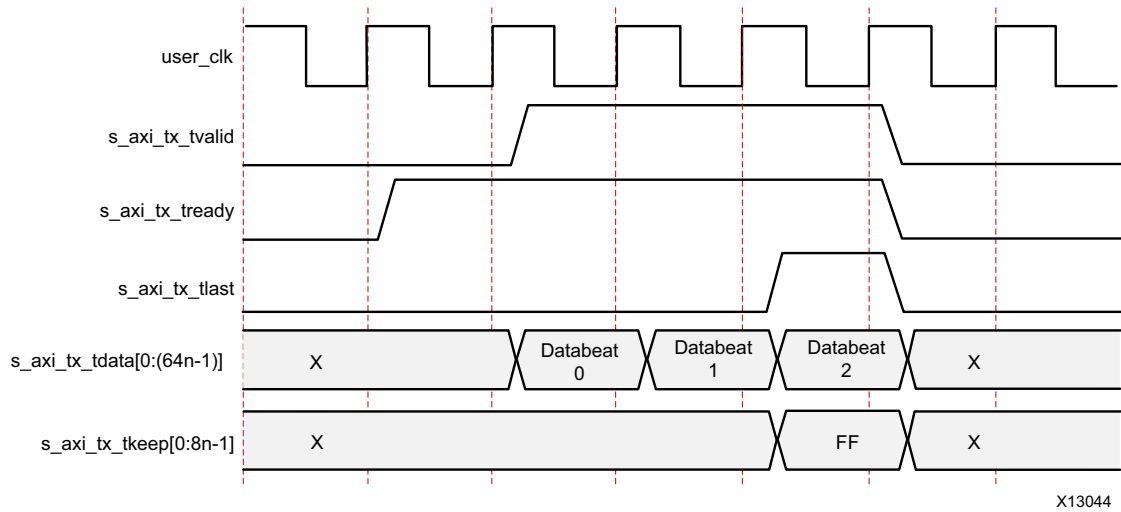

Figure 2-8: Simple Data Transfer

To begin the data transfer, the user application asserts `s_axi_tx_tvalid` and provides the first  $n$  bytes of the user frame. Because `s_axi_tx_tready` is already asserted, data transfer begins on the next clock edge. The data bytes are placed in data blocks and transferred through the Aurora 64B/66B channel.

To end the data transfer, the user application asserts `s_axi_tx_tlast`, `s_axi_tx_tvalid`, the last data bytes, and the appropriate `TKEEP` value (`0xFF`) on the `s_axi_tx_tkeep` bus. The core sends the final data word in blocks, and must send an empty separator block on the next cycle to indicate the end of the frame. `s_axi_tx_tready` is reasserted on the next cycle so that more data transfers can continue. If there is no new data, the Aurora 64B/66B core sends idles.



**Example B: Data Transfer with Pause**

Figure 2-9 shows the user application pausing data transmission during a frame transfer. The application sends  $3n$  bytes of data and pauses the data flow after the first  $n$  bytes. After the first data word, the application deasserts `s_axi_tx_tvalid` causing the TX to ignore all data on the bus and transmit idle blocks. The pause continues until `s_axi_tx_tvalid` is asserted.

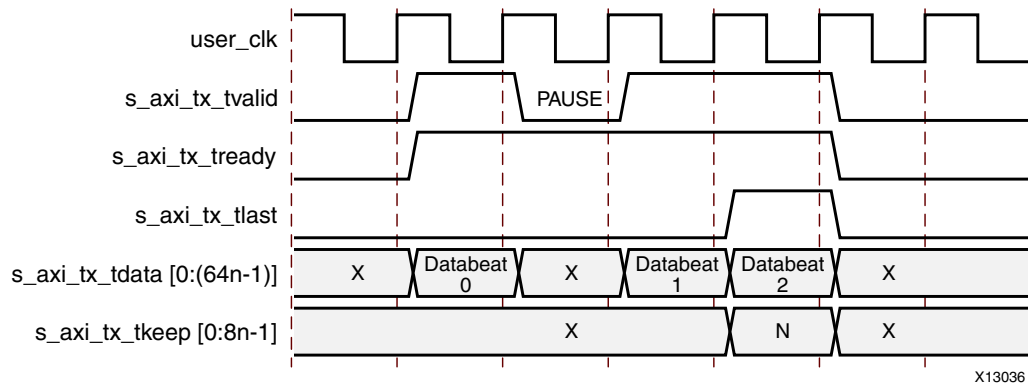
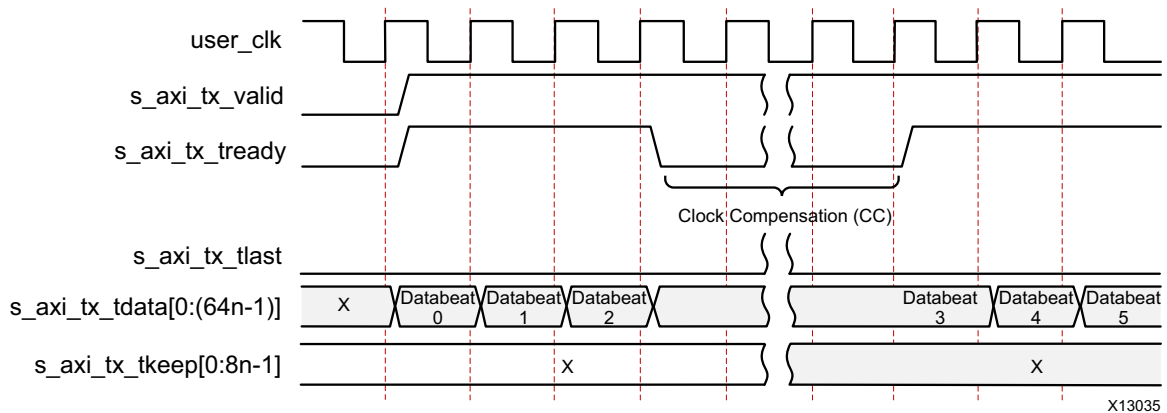

Figure 2-9: Data Transfer with Pause

**Example C: Data Transfer with Clock Compensation**

Figure 2-10 shows the core automatically interrupting data transmission when clock compensation sequences are sent.



**Notes:**

1. When clock compensation is transmitted, uninterrupted data transmission is not possible. See [Clock Compensation Logic](#) for more information about when clock compensation is required.

Figure 2-10: Data Transfer Paused by Clock Compensation

## Receiving Data

Because the core has no built-in buffer for user data, there is no `m_axi_rx_tready` signal on the RX AXI4-Stream interface. User application control of the flow of data from an Aurora 64B/66B channel is limited to one of the optional core flow control features.

The `m_axi_rx_tvalid` signal is asserted concurrently with the first word of each frame from the core. The `m_axi_rx_tlast` signal is asserted concurrently with the last word or partial word of each frame. The `m_axi_rx_tkeep` port indicates the number of valid bytes in the final word of each frame using the same byte indication procedure as `s_axi_tx_tkeep`. All bytes valid is indicated (all 1s) when `m_axi_rx_tlast` is not asserted and the exact number of bytes valid is specified when `m_axi_rx_tlast` is asserted.

If the CRC option is selected, the received data stream is computed for the expected CRC value. The CRC block re-calculates the `m_axi_rx_tkeep` value and correspondingly asserts `m_axi_rx_tlast`.

The core can deassert `m_axi_rx_tvalid` anytime, even during a frame.

### Example A: Data Reception with Pause

Figure 2-11 shows an example of  $3n$  bytes of received data interrupted by a pause. Data is presented on the `m_axi_rx_tdata` bus. When the first  $n$  bytes are placed on the bus, the `m_axi_rx_tvalid` output is asserted to indicate that data is ready for the user application.

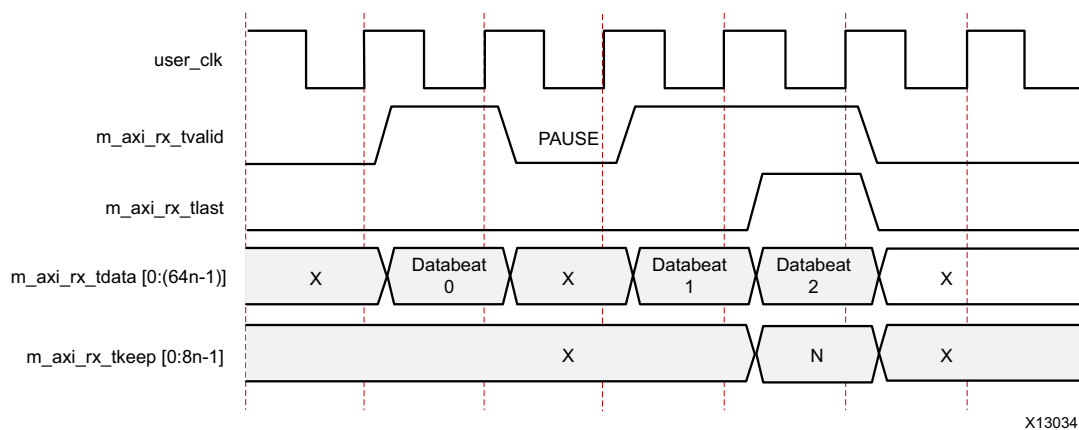

Figure 2-11: Data Reception with Pause

After the pause, the core asserts `m_axi_rx_tvalid` and continues to assemble the remaining data on the `m_axi_rx_tdata` bus. At the end of the frame, the core asserts `m_axi_rx_tlast`. The core also computes the value of the `m_axi_rx_tkeep` bus and presents it to the user application based on the total number of valid bytes in the final word of the frame.

### Framing Efficiency

There are two factors that affect framing efficiency in the Aurora 64B/66B core:

1. The size of the frame.
2. A data invalid request from the gearbox that occurs after every 32 `user_clk` cycles.

The clock compensation (CC) sequence, which uses three `user_clk` cycles on every lane every 10,000 `user_clk` cycles, consumes about 0.03% of the total channel bandwidth.

The gearbox in GTX and GTH transceivers requires a periodic pause to account for the clock divider ratio and 64B/66B encoding. This appears as a back pressure in the AXI4-Stream interface and the user data needs to be stopped for one cycle after every 32 cycles (Figure 2-12). The `s_axi_tx_tready` signal in the user interface from the Aurora 64B/66B core is deasserted for one cycle, once after every 32 cycles. The pause cycle is used to compensate the gearbox for the 64B/66B encoding.

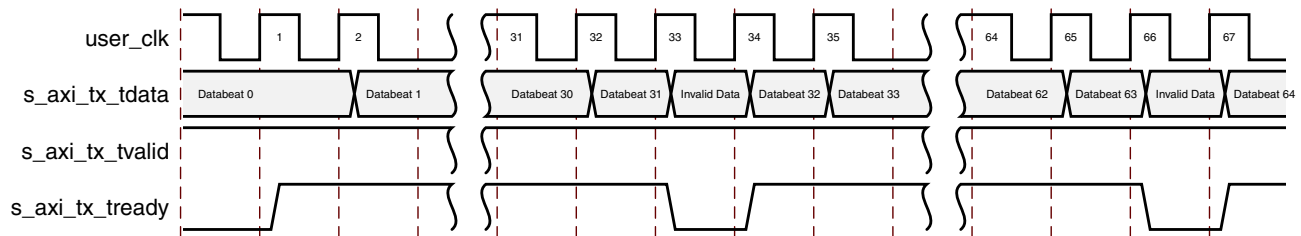

Figure 2-12: Framing Efficiency

For more information on gearbox pause in GTX/GTH/GTY transceivers, see the *7 Series FPGAs GTX/GTH Transceivers User Guide* (UG476) [Ref 7] or *UltraScale FPGAs GTH Transceivers User Guide* (UG576) [Ref 5] or *UltraScale Architecture GTY Transceivers User Guide* (UG578) [Ref 6], when applicable.

The Aurora 64B/66B core implements the Strict Aligned option of the Aurora 64B/66B protocol. No data blocks are placed after idle blocks or SEP blocks on a given cycle. Table 2-4 is an example calculated after including overhead for clock compensation and shows the efficiency for a single-lane channel while illustrating that the efficiency increases as frame length increases.

Table 2-4: Framing Efficiency Example

User Data Bytes	Percent Framing Efficiency
100	96.12
1,000	99.18
10,000	99.89

Table 2-5 shows the overhead in a single-lane channel when transmitting 256 bytes of frame data. The resulting data unit is 264 bytes long due to the end-of-frame SEP block. This results in a 3.03% transmitter overhead. Also, the clock compensation blocks must be transmitted for three cycles every 10,000 cycles resulting in an additional 0.03% overhead in the transmitter.

Table 2-5: Typical Overhead for Transmitting 256 Data Bytes

Lane	Clock	Function
[D0:D7]	1	Channel frame data
[D8:D15]	2	Channel frame data
	.	.
	.	.
	.	.
[D248:D255]	32	Channel frame data
Control block	33	SEP0 block

### Streaming Interface

The streaming interface (Figure 2-13) allows data transmission without frame delimiters thus making it simple to operate while using less resources than for the framing interface.

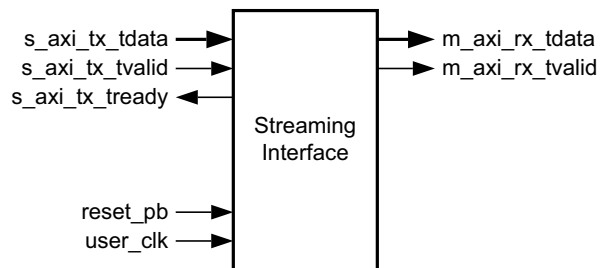

Figure 2-13: Aurora 64B/66B Streaming User Interface (AXI4-Stream)

### Transmitting and Receiving Data

In streaming, the Aurora 64B/66B channel is used as a pipe. The streaming Aurora 64B/66B interface expects data to be filled for the entire `s_axi_tx_tdata` port width (integral multiple of eight bytes). When `s_axi_tx_tvalid` is deasserted, gaps are created between words that are preserved except when clock compensation sequences are being transmitted.

When data arrives at the RX side of the Aurora 64B/66B channel, it must be read immediately or it is lost. If this is unacceptable, a buffer must be connected to the RX interface to hold the data until it can be used.

**Example A: TX Streaming Data Transfer**

Figure 2-14 shows a typical streaming data transfer beginning with neither of the ready signals asserted to indicate that both the user logic and the core are not ready to transfer data. During the next clock cycle, the core indicates that it is ready to transfer data by asserting `s_axi_tx_tready`. One cycle later, the user logic asserts the `s_axi_tx_tvalid` signal and places data on the `s_axi_tx_tdata` bus indicating that it is ready to transfer data. Because both signals are now asserted, data D0 is transferred from the user logic to the core. Data D1 is transferred on the following clock cycle. In this example, the core deasserts its ready signal, `s_axi_tx_tready`, and no data is transferred until the next clock cycle when, again, the `s_axi_tx_tready` signal is asserted. Then the user application deasserts `s_axi_tx_tvalid` on the next clock cycle and no data is transferred until both signals are asserted.

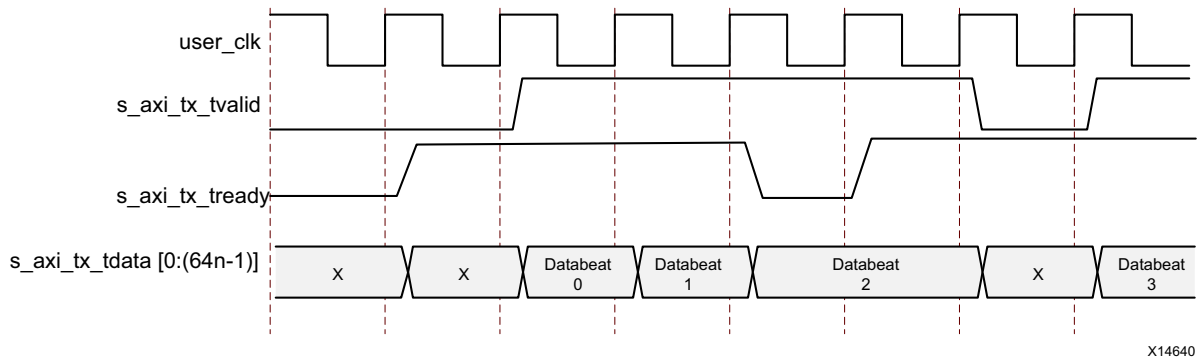

X14640

Figure 2-14: Typical Streaming Data Transfer

**Example B: RX Streaming Data Transfer**

Figure 2-15 shows a typical streaming data reception example.

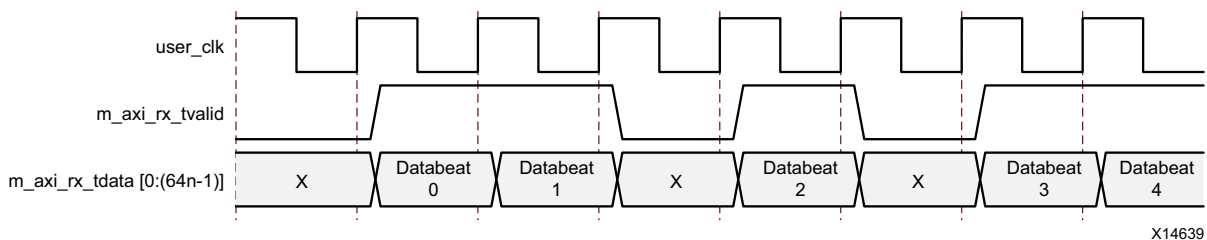

X14639

Figure 2-15: Typical Streaming Data Reception

## Clock Interface

Table 2-6 describes the core clock ports. In GTX and GTH transceiver designs, the reference clock can be taken from the GTXQ/GTHQ signal, which is a differential input clock for each GTX or GTH transceiver. The reference clock for GTX/GTH transceivers is provided through the `clkin` port. For more details on the clock interface, see [Clocking, page 55](#).



**IMPORTANT:** *This interface is most critical for correct Aurora 64B/66B core operation. The clock interface has ports for the reference clocks that drive the GTX or GTH transceivers and ports for the parallel clocks that the core shares with application logic.*

Table 2-6: Aurora 64B/66B Core Clock Ports

Name	Direction	Clock Domain	Description
init_clk/init_clk_p/init_clk_n	Input	-	<p>The init_clk signal is used to register and debounce the pma_init signal. The preferred init_clk range is 50 to 200 MHz. The default init_clk frequency set by the core is 50 MHz for 7 series designs and line_rate/64 for UltraScale architecture designs. init_clk frequency is a user-configurable parameter. With the <b>Include Shared Logic in core</b> option, the init_clk signal is differential. The <b>Single Ended INIT CLK</b> option provides single-ended init_clk input.</p> <p>For UltraScale architecture designs: The init_clk frequency should be <math>\leq</math> TXUSERCLK frequency and the value should not exceed 200 MHz. Refer to the <i>UltraScale Architecture GTH Transceivers User Guide</i> (UG576) [Ref 5] or <i>UltraScale Architecture GTY Transceivers User Guide</i> (UG578) [Ref 6], when applicable. for more details. init_clk is also connected to the DRPCLK port of the GTHE3/GTYE3/GTHE4/GTYE4 CHANNEL interface.</p>
init_clk_out <sup>(2)</sup>	Output	init_clk	Init clock output. Not available for <b>Single Ended INIT CLK</b> option.

Table 2-6: Aurora 64B/66B Core Clock Ports (Cont'd)

Name	Direction	Clock Domain	Description
mmcm_not_locked	Input	init_clk	If mixed-mode clock manager (MMCM) is used to generate clocks for the Aurora 64B/66B core, the mmcm_not_locked signal should be connected to the inverse of the serial transceiver phase-locked loop (PLL) locked signal. The clock modules provided with the core use the PLL for clock division. The mmcm_not_locked signal from the clock module should be connected to the core mmcm_not_locked signal. The mmcm_not_locked signal is available when shared logic is included in the example design.
mmcm_not_locked_out	Output	init_clk	For UltraScale devices: mmcm_not_locked is connected to gtwiz_userclk_tx_active_out driven from the <user_component_name>_ultrascale_tx_userclk module. The signal is driven based on the clocking helper core status and signifies that the helper core is out of reset. Active High signal. The mmcm_not_locked_out signal is available when shared logic is included in the core. The mmcm_not_locked is part of the CORE_CONTROL interface. mmcm_not_locked_out is part of the CORE_STATUS interface.
user_clk	Input		Parallel clock shared by the core and the user application. The user_clk signal is a BUFG output deriving its input from tx_out_clk. The clock generators are available in the <component name>_clock_module file. user_clk serves as the txusrclk2 input to the transceiver. See the related transceiver user guide/data sheet for rate-related information. user_clk is available when shared logic is included in the example design. user_clk_out is the user clock output which is available when shared logic is included in the core.
user_clk_out <sup>(2)</sup>	Output	user_clk	
tx_out_clk	Output	tx_out_clk	Generated from the GTX or GTH transceiver reference clock based on the transceiver PLL frequency setting. Should be buffered and used to generate the user clock for the logic connected to the core.
bufg_gt_clr_out <sup>(6)</sup>	Output	init_clk	This signal needs to be connected to the clock locked input of the clock module when using shared logic in the example design.

Table 2-6: Aurora 64B/66B Core Clock Ports (Cont'd)

Name	Direction	Clock Domain	Description
sync_clk	Input	-	Parallel clock used by the serial transceiver internal synchronization logic. Provided as the txusrclk signal to the transceiver interface. The sync_clk is twice the rate of user_clk. See the related transceiver user guide/data sheet for rate-related information. sync_clk is available when shared logic is included in the example design. sync_clk_out is the sync clock output. This port is not available in RX-only_Simplex mode.
sync_clk_out <sup>(2)</sup>	Output	sync_clk	
gt_refclk1_p/gt_refclk1_n gt_refclk2_p/gt_refclk2_n refclk1_in refclk2_in	Input	-	gt_refclk (clkp/clkn) is a dedicated external clock generated from an oscillator and fed through a dedicated IBUFDS. <ul style="list-style-type: none"> <li>gt_refclk1_p/gt_refclk1_n = Differential Transceiver Reference Clock 1<sup>(2)</sup>.</li> <li>gt_refclk2_p/gt_refclk2_n = Differential Transceiver Reference Clock 2<sup>(3)</sup></li> <li>refclk1_in = Single Ended Transceiver Reference Clock 1<sup>(4)</sup>.</li> <li>refclk2_in = Single Ended Transceiver Reference Clock 2<sup>(5)</sup>.</li> <li>gt_refclk1_out = Single Ended Transceiver Reference Clock 1<sup>(2)</sup>.</li> <li>gt_refclk2_out = Single Ended Transceiver Reference Clock 1<sup>(3)</sup>. Not available for the <b>Single Ended GT REFCLK</b> option.</li> </ul> For GTY transceivers the throughput varies from 0.48 Gb/s to 399.99 Gb/s with the supported line rate range of 0.5 Gb/s to 25.7813 Gb/s.
gt_refclk1_out gt_refclk2_out	Output	-	
gt_rxusrclk_out <sup>(7)</sup>	Output	rxoutclk	Receiver recovered clock from the master GT channel of the Aurora64b66b core. This output clock port is enabled only when Additional Transceiver Control and Status Ports option is enabled during the Aurora64b66b core customization.



Table 2-6: Aurora 64B/66B Core Clock Ports (Cont'd)

Name	Direction	Clock Domain	Description
gt_qpllclk_quad<quad_no>_in, gt_qpllrefclk_quad<quad_no>_in <sup>(1)</sup>	Input	-	Clock inputs generated by GTXE2_COMMON/GTHE2_COMMON/GTHE3_COMMON.
gt_qpllclk_quad<quad_no>_out, gt_qpllrefclk_quad<quad_no>_out <sup>(1)</sup>	Output	-	Clock outputs generated by GTXE2_COMMON/GTHE2_COMMON/GTHE3_COMMON. If the line rate is < 6.6 Gb/s in the GTX transceivers and < 8.0 Gb/s in 7 series and UltraScale FPGAs GTH transceivers, the gt_qpllclk_quad<quad_no>_out signal is tied High.

**Notes:**

1. In 7 series, *quad\_no* varies from 1 to the number of active transceiver quads –1. In UltraScale FPGAs, varies from 1 to the number of active transceiver quads.
2. Enabled when **Include Shared Logic in Core** is selected.
3. Enabled when **Include Shared Logic in Core** is selected and more than one reference clock is required.
4. Enabled when **Include Shared Logic in Example Design** is selected or enabled when **Include Shared Logic in Core** is selected and if the single-ended option is selected.
5. Enabled when **Include Shared Logic in Example Design** is selected and more than one reference clock is required or enabled when **Include Shared Logic in Core** is selected and more than one reference clock is required and if the single-ended option is selected.
6. Enabled when **Include Shared Logic in Example Design** is selected for UltraScale architecture based designs.
7. gt\_rxusrclk\_out is the output from BUFGCE which has the input source clock as rxoutclk from the GT in 7 series devices. In UltraScale, It is the output from UltraScale GT RX clocking helper module.

## Flow Control Interface

The flow control interface consists of three configurations: the native flow control, the user flow control, and the USER-K flow control interfaces.

### Native Flow Control Interface

The Aurora 64B/66B protocol includes Native Flow Control (NFC) allowing receivers to control the rate at which data is sent by specifying the number of cycles during which the channel partner cannot send data. The data flow can even be turned off completely (XOFF) by requesting that the transmitter temporarily send only idles. NFC is typically used to prevent FIFO overflow conditions. [Figure 2-16](#) and [Table 2-7](#) detail the NFC port interface.

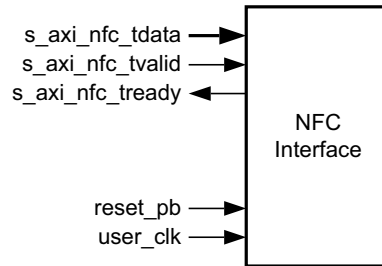

Figure 2-16: NFC Port Interface

Table 2-7: Native Flow Control (NFC) Interface Ports

Name	Direction	Clock Domain	Description
<b>NFC_S_AXIS_TX</b>			
s_axi_nfc_tx_tvalid	Input	user_clk	Asserted (High) to request sending an NFC message to the channel partner. Must be held until s_axi_nfc_tx_tready is asserted.
s_axi_nfc_tx_tready	Output	user_clk	Asserted (High) when an Aurora 64B/66B core accepts an NFC request.
s_axi_nfc_tx_tdata[0:15] or s_axi_nfc_tx_tdata[15:0]	Input	user_clk	Incoming NFC message data from the channel partner.

For a detailed explanation of NFC operation, see the *Aurora 64B/66B Protocol Specification* (SP011) [Ref 9].

**Note:** NFC completion mode is not applicable to streaming designs.

Figure 2-17 and Figure 2-18 show the NFC message format in big endian (default) and little endian modes.

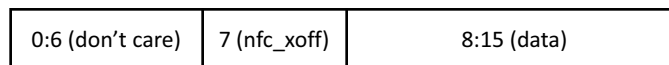

Figure 2-17: NFC Message in Default Big Endian Mode

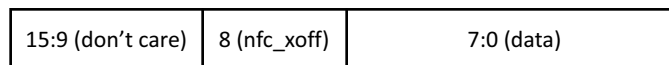

Figure 2-18: NFC Message in Little Endian Mode

**Note:**

- [n:0] bus format is used when the **Little Endian** support option is selected. [0:n] bus format is used when the **Big Endian** support option is selected. The core has an option to configure the AXI4-Stream User I/O as little endian from the Vivado IDE. The default is big endian.
- Ports are active-High unless specified otherwise.

### NFC Message in Default Mode

To send an NFC message to a channel partner, the user application asserts `s_axi_nfc_tx_tvalid` and writes an 8-bit pause count to `s_axi_nfc_tx_tdata[8:15]`. The pause code indicates the minimum number of cycles the channel partner must wait after receiving an NFC message prior to resuming data send. The number of `user_clk` cycles without data is equal to `s_axi_nfc_tx_tdata + 1`.

When asserted, the `s_axi_nfc_tx_tdata[7]` signal indicates `nfc_xoff`, requesting that the channel partner stop sending data until it receives a non-XOFF NFC message or reset. When a request is transmitted with PAUSE and XOFF both set to 0, NFC is set to XON mode. To cancel XOFF mode, all 0s (XON) should be transmitted. After reception of this XON request, any new NFC request is honored by the core. The user application must hold `s_axi_nfc_tx_tvalid`, `s_axi_nfc_tx_tdata[8:15]`, and `s_axi_nfc_tx_tdata[7]` (`nfc_xoff`, if used) until `s_axi_nfc_tx_tready` is asserted on a positive `user_clk` edge indicating that the core can transmit the NFC message.

Aurora 64B/66B cores cannot transmit data while sending NFC messages. `s_axi_tx_tready` is always deasserted on the cycle following an `s_axi_nfc_tx_tready` assertion. NFC Completion mode is available only for the framing Aurora 64B/66B interface.

### Example A: Transmitting an NFC Message

Figure 2-19 shows an example of the transmit timing when the user application sends an NFC message to a channel partner using an AXI4-Stream interface.

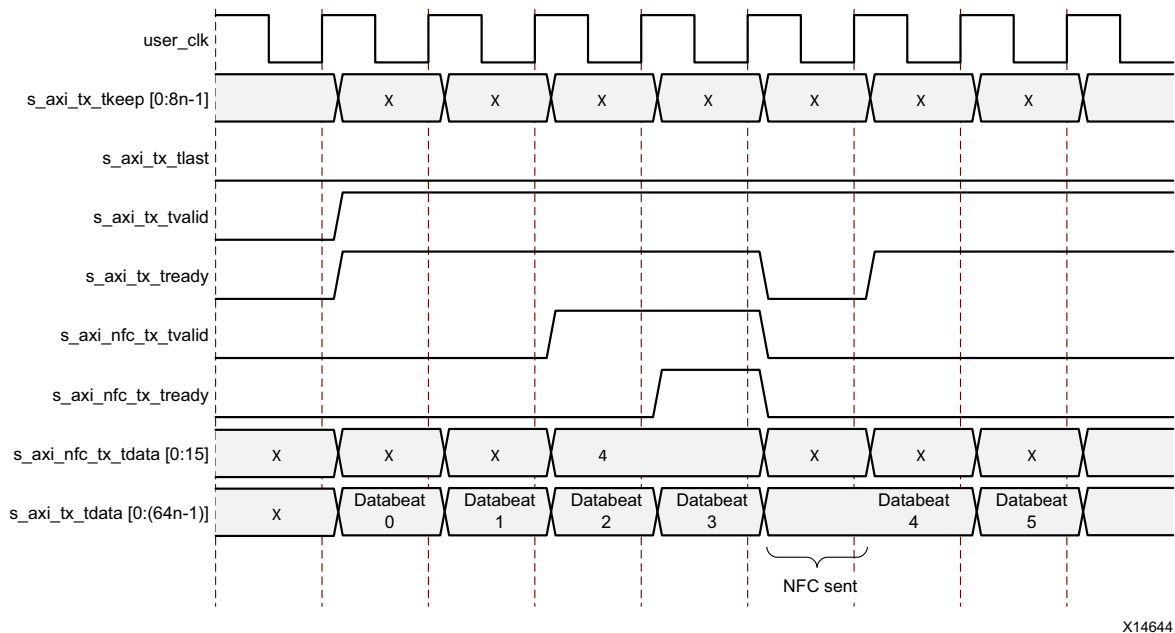

Figure 2-19: Transmitting an NFC Message

**Note:** Signal `s_axi_tx_tready` is deasserted for one cycle to create the gap in the data flow in which the NFC message is placed.

**Example B: Receiving a Message with NFC Idles Inserted**

Figure 2-20 shows an example of the TX user interface signals in immediate NFC mode when an NFC message is received. The NFC message sends `8'b01`, requesting two cycles without data transmission. The core deasserts `s_axi_tx_tready` to prevent data transmission for two cycles.

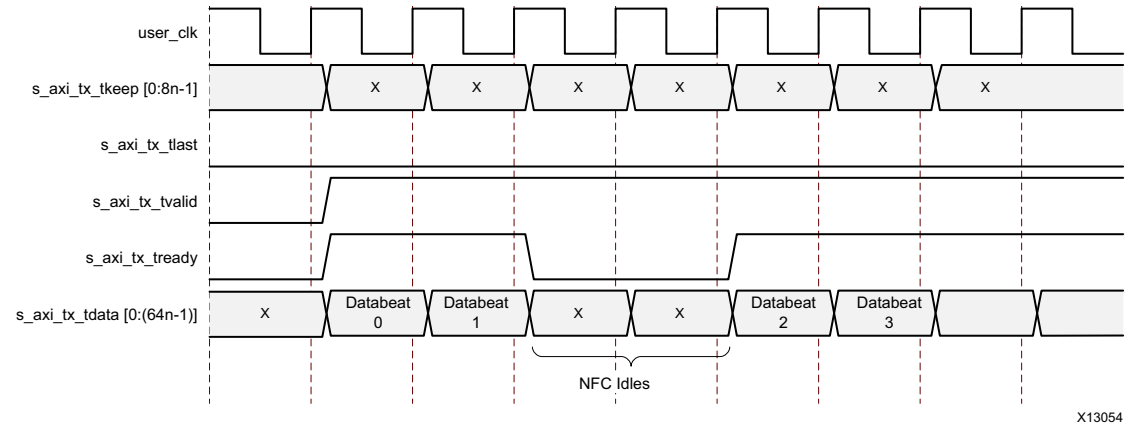

Figure 2-20: Transmitting a Message with NFC Idles Inserted

Aurora 64B/66B cores can also operate in completion mode where NFC idles are only inserted before the first data bytes of a new frame. If a completion mode core receives an NFC message while it is transmitting a frame, the core finishes transmitting the frame before deasserting `s_axi_tx_tready` to insert idles.

**User Flow Control Interface**

The Aurora 64B/66B protocol includes user flow control (UFC) to allow channel partners to send control information using a separate in-band channel. Applications send short UFC messages to the channel partner without waiting for the frame in progress to end. The higher priority UFC message shares the channel with lower-priority regular frame data. UFC messages are interruptible by high-priority control blocks such as Clock Compensation (CC)/Not Ready Idles (NR)/Channel Bonding (CB)/NFC blocks. UFC message interruption is visible when the UFC option is selected.

Figure 2-21 shows the UFC port interface. Table 2-8 describes the UFC interface ports.

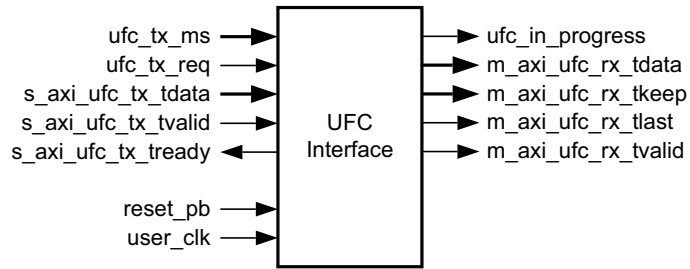

Figure 2-21: UFC Port Interface

Table 2-8: User Flow Control (UFC) Interface Ports

Name	Direction	Clock Domain	Description
<b>UFC_S_AXIS_TX</b>			
ufc_tx_req <sup>(2)</sup>	Input	user_clk	ufc_tx_req indicates a UFC message request to send by the channel partner. After a request, the s_axi_ufc_tx_tdata bus is ready to send data after two cycles unless interrupted by a higher priority event. The s_axi_ufc_tx_tvalid must be asserted when you want to send a UFC request.
ufc_tx_ms[0:7] or ufc_tx_ms[7:0] <sup>(2)</sup>	Input	user_clk	Specifies the number of bytes in the UFC message (message size). The maximum UFC message size is 256 bytes. The value specified is one less than the actual number of bytes transferred (a value of 3 transmits 4 bytes of data).
s_axi_ufc_tx_tready	Output	user_clk	Indicates the Aurora 64B/66B core is ready to accept UFC data on s_axi_ufc_tx_tdata. This signal is asserted two clock cycles after ufc_tx_req when no high-priority requests are in progress. s_axi_ufc_tx_tready continues to be asserted while the core waits for data for the most recently requested UFC message. The signal is deasserted for CC, CB, and NFC requests which are higher priority. While s_axi_ufc_tx_tready is asserted, s_axi_tx_tready is deasserted.
s_axi_ufc_tx_tdata[0:(64n-1)] or s_axi_ufc_tx_tdata[(64n-1):0] <sup>(1)</sup>	Input	user_clk	Input bus for Aurora 64B/66B channel UFC message data. Sampled only if s_axi_ufc_tx_tvalid and s_axi_ufc_tx_tready are asserted. If the number of message bytes is not an integer multiple of the bus width in bytes, the only bytes used are those needed on the last cycle to finish the message starting from the leftmost byte of the bus.

Table 2-8: User Flow Control (UFC) Interface Ports (Cont'd)

Name	Direction	Clock Domain	Description
s_axi_ufc_tx_tvalid	Input	user_clk	Indicates valid UFC data on s_axi_ufc_tx_tdata. If deasserted while s_axi_ufc_tx_tready is asserted, Idle blocks are sent in the UFC message.
<b>UFC_M_AXIS_RX</b>			
m_axi_ufc_rx_tdata[0:(64n-1)] or m_axi_ufc_rx_tdata[(64n-1):0] <sup>(1)</sup>	Output	user_clk	Incoming UFC message data from the channel partner.
m_axi_ufc_rx_tvalid	Output	user_clk	Indicates valid UFC data on the m_axi_ufc_rx_tdata port. When not asserted, all values on the m_axi_ufc_rx_tdata port should be ignored.
m_axi_ufc_rx_tlast	Output	user_clk	Indicates the end of the incoming UFC message.
m_axi_ufc_rx_tkeep[0:(8n-1)] or m_axi_ufc_rx_tkeep[(8n-1):0] <sup>(1)</sup>	Output	user_clk	Specifies the number of valid data bytes presented on the m_axi_ufc_rx_tdata port on the last word of a UFC message. Valid only when m_axi_ufc_rx_tlast is asserted. Each bit indicates one valid byte. Maximum size of the UFC message is 256 bytes.
ufc_in_progress <sup>(3)</sup>	Output	user_clk	Specifies the status of the current UFC transmission. This is an active-Low signal. A Low on this port indicates that UFC reception is in progress.

**Notes:**

1.  $n$  is the number of lanes.
2. ufc\_tx\_req and ufc\_tx\_ms are available just below the UFC\_S\_AXIS\_TX interface.
3. ufc\_in\_progres is available just below the UFC\_M\_AXIS\_RX interface.

**Transmitting UFC Messages**

To send a UFC message, the application asserts ufc\_tx\_req while driving ufc\_tx\_ms with the desired SIZE code for a single cycle. After a request, a new request cannot be made until s\_axi\_ufc\_tx\_tready is asserted for the final cycle of the previous request. The UFC message data must be placed on s\_axi\_ufc\_tx\_tdata and the s\_axi\_ufc\_tx\_tvalid signal must be asserted whenever the bus contains valid message data.

The core deasserts s\_axi\_tx\_tready while sending UFC data and keeps s\_axi\_ufc\_tx\_tready asserted until it has enough data to complete the requested message. If s\_axi\_ufc\_tx\_tvalid is deasserted during a UFC message, idles are sent, s\_axi\_tx\_tready remains deasserted, and s\_axi\_ufc\_tx\_tready remains asserted. If a CC, CB, or NFC request is made, s\_axi\_ufc\_tx\_tready is deasserted while the requested operation is performed because CC, CB, and NFC requests have higher priority.

**Note:** The `s_axi_tx_tready` and `s_axi_ufc_tx_tready` signals are deasserted for one cycle before the core accepts message data to allow the UFC header to be sent.

**Example A: Transmitting a Single-Cycle UFC Message**

Figure 2-22 shows the procedure for transmitting a single-cycle UFC message. This example shows a 4-byte message being sent on an 8-byte interface.

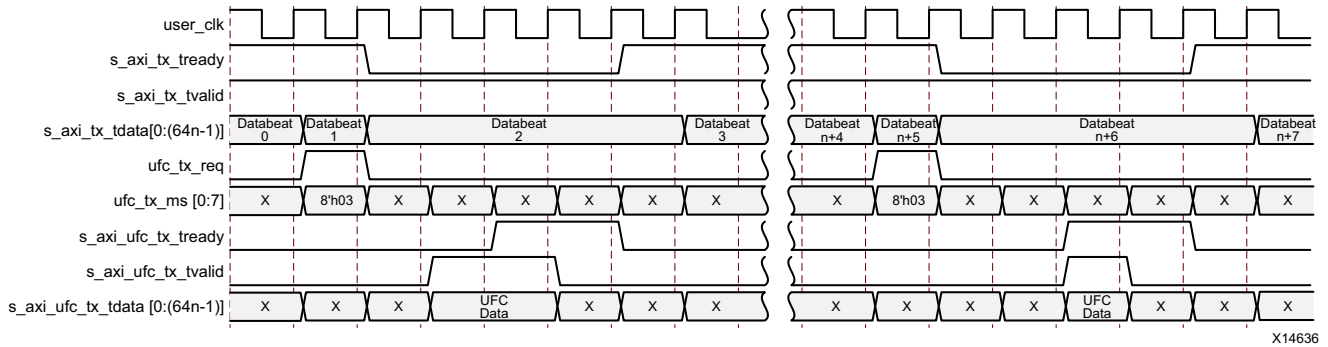

Figure 2-22: Transmitting a Single-Cycle UFC Message

**Example B: Transmitting a Multicycle UFC Message**

Figure 2-23 shows the procedure for transmitting a two-cycle UFC message. This example shows a 16-byte message being sent on an 8-byte interface.

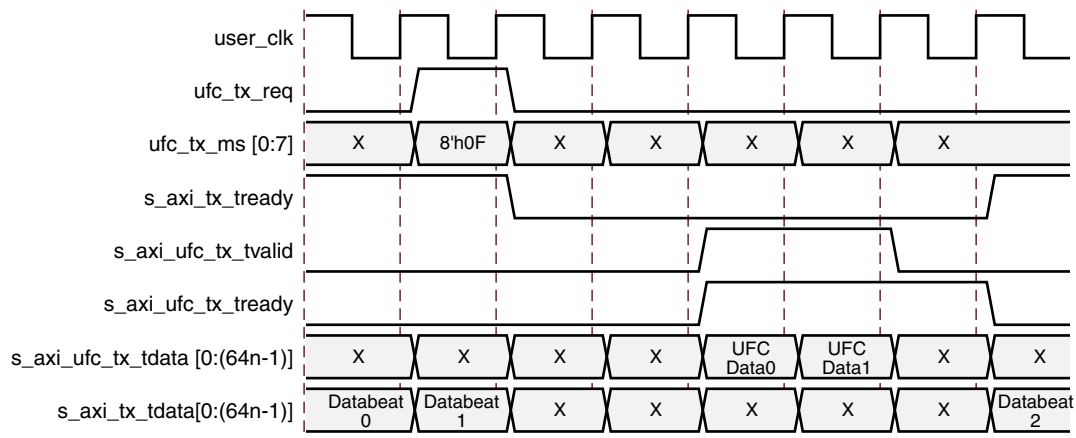

Figure 2-23: Transmitting a Multi-Cycle UFC Message

**Example C: Receiving a Single-Cycle UFC Message**

Figure 2-24 shows an Aurora 64B/66B core with an 8-byte data interface receiving a 4-byte UFC message. The core presents this data to the application by asserting `m_axi_ufc_rx_tvalid` and `m_axi_ufc_rx_tlast` indicating a single-cycle frame. The `m_axi_ufc_rx_tkeep` bus is set to `0xF`, indicating only the four most significant interface bytes are valid (each bit in `TKEEP` indicates a valid byte in the UFC data).

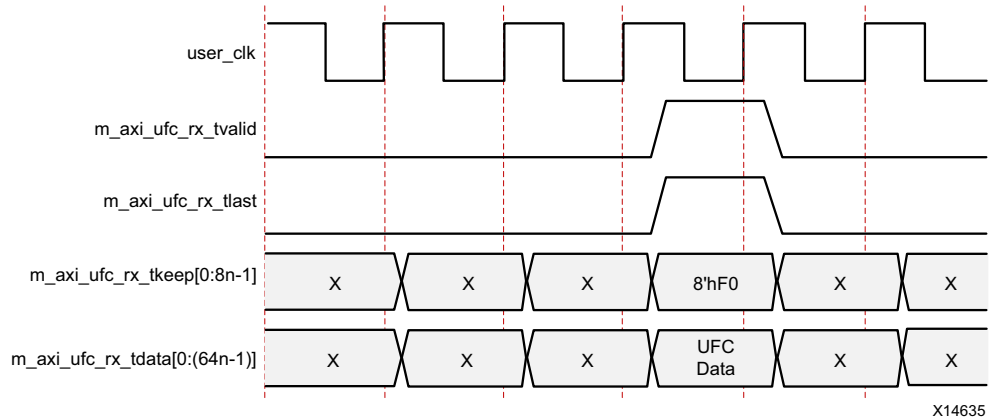

Figure 2-24: Receiving a Single-Cycle UFC Message

**Example D: Receiving a Multicycle UFC Message**

Figure 2-25 shows an Aurora 64B/66B core with an 8-byte interface receiving a 15-byte message. The resulting frame is two cycles long, with `m_axi_ufc_rx_tkeep` set to `8'hFF` for the first cycle indicating that all bytes are valid and `8'hFE` for the second cycle indicating that seven of the bytes are valid.

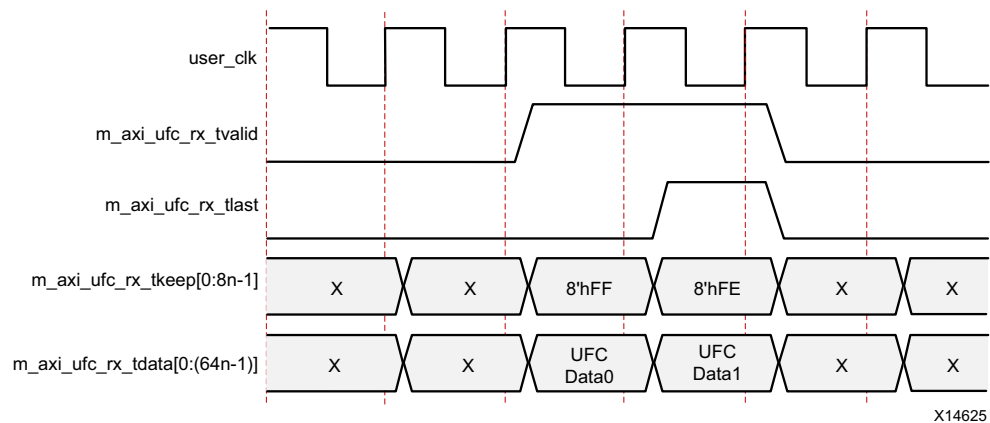

Figure 2-25: Receiving a Multi-Cycle UFC Message



## USER-K Block Interface

Figure 2-26 shows the USER-K interface ports for a single-lane design with the USER-K interface enabled.

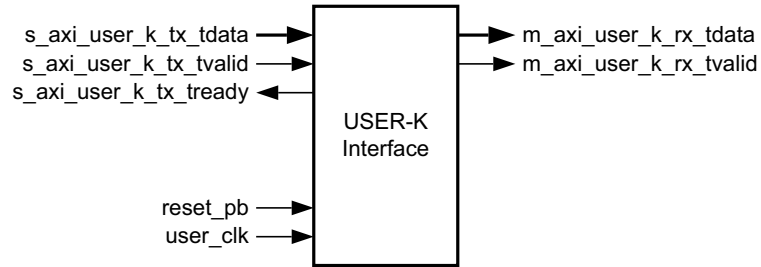

Figure 2-26: USER-K Port Interface

USER-K blocks are special, single-block codes that include control blocks passed directly to the user application without being decoded by the Aurora 64B/66B interface. These blocks can be used to implement application-specific control functions and have a lower priority than UFC blocks but higher than user data blocks.

Table 2-9 lists the USER-K interface ports.

Table 2-9: USER-K Interface Ports

Name	Direction	Clock Domain	Description
<b>USER_K_S_AXIS_TX</b>			
s_axi_user_k_tx_tdata[0:(64n-1)] or s_axi_user_k_tx_tdata[(64n-1):0] <sup>(1)</sup>	Input	user_clk	USER-K block data is 64-bit aligned. Signal Mapping per lane: Default: s_axi_user_k_tx_tdata={{4'h0,user_k_blk_no[0:3],user_k_data[55:0]}*n} Little endian format: s_axi_user_k_tx_tdata={{user_k_data[55:0],4'h0,user_k_blk_no[3:0]}*n}.
s_axi_user_k_tx_tvalid	Input	user_clk	Indicates valid User-K data on the s_axi_user_k_tx_tdata port.
s_axi_user_k_tx_tready	Output	user_clk	Indicates the Aurora 64B/66B core is ready to accept data on the s_axi_user_k_tx_tdata interface.

Table 2-9: USER-K Interface Ports (Cont'd)

Name	Direction	Clock Domain	Description
<b>USER_K_M_AXIS_RX</b>			
m_axi_rx_user_k_tvalid	Output	user_clk	Indicates valid User-K data on the m_axi_user_k_tx_tdata port.
m_axi_rx_user_k_tdata or m_axi_rx_user_k_tdata[(64n-1):0] <sup>(1)</sup>	Output	user_clk	Received USER-K blocks from the Aurora 64B/66B lane are 64-bit aligned. Signal Mapping per lane: Default: m_axi_rx_user_k_tdata = {{4'h0,user_k_blk_no[0:3],user_k_data[55:0]}*n} Little endian format: m_axi_rx_user_k_tdata = {{user_k_data[55:0],4'h0,user_k_blk_no[3:0]}*n}.

**Notes:**

1.  $n$  is the number of lanes.

The USER-K block is not differentiated for streaming or framing designs. Each USER-K block is eight-bytes wide and is encoded with a USER-K BTF value as specified in Table 2-10. The BTF value is indicated by the user application in the s\_axi\_user\_k\_tx\_tdata port as a USER-K block number. The USER-K block is a single block code and is always delineated by a USER-K block number. Provide the USER-K block number as specified in Figure 2-27 and Figure 2-28. The USER-K block data is limited to the specified seven bytes of the s\_axi\_user\_k\_tx\_tdata port.

Table 2-10: USER-K Block Valid Block Type Field (BTF) Values

USER-K Block Number	USER-K Block BTF
USER-K Block 0	0xD2
USER-K Block 1	0x99
USER-K Block 2	0x55
USER-K Block 3	0xB4
USER-K Block 4	0xCC
USER-K Block 5	0x66
USER-K Block 6	0x33
USER-K Block 7	0x4B
USER-K Block 8	0x87

Figure 2-27 shows the USER-K format in default (big-endian) mode.

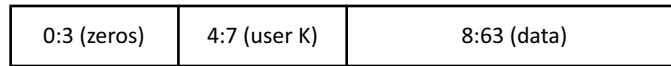

Figure 2-27: USER-K Format in Default Mode

Figure 2-28 shows the USER-K format in little-endian mode.



Figure 2-28: USER-K Format in Little-Endian Mode

### Transmitting USER-K Blocks

The `s_axi_user_k_tx_tready` signal is asserted by the core and is prioritized by CC, CB, NFC, and UFC messages. After asserting `s_axi_user_k_tx_tdata`, the USER-K block number and `s_axi_user_k_tx_tvalid` is asserted. If required, the user application can change `s_axi_user_k_tx_tdata` when `s_axi_user_k_tx_tready` is asserted (Figure 2-29). This action enables the Aurora 64B/66B core to select the appropriate USER-K BTF from the nine USER-K blocks. The data available during assertion of `s_axi_user_k_tx_tready` is always serviced.

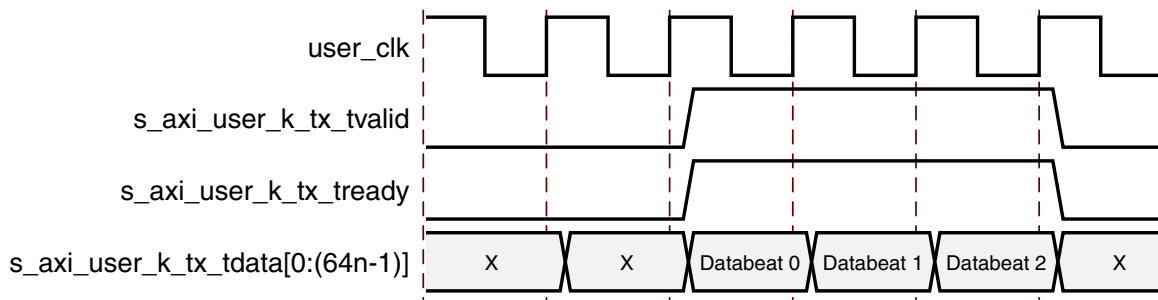

Figure 2-29: Transmitting USER-K Data and USER-K Block Number

### Receiving USER-K Blocks

The receive BTF is decoded and the block number for the corresponding BTF is passed to the user application (Figure 2-30). The user application can validate the data available on `m_axi_rx_user_k_tdata` when `m_axi_rx_user_k_tvalid` is asserted.

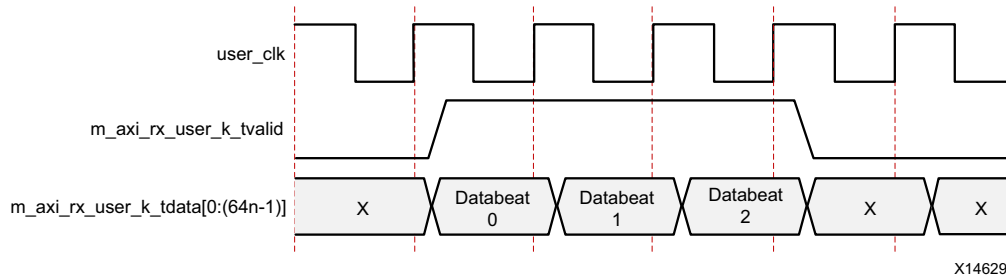

Figure 2-30: Receiving USER-K Data and USER-K Block Number

## Status, Control and the Transceiver Interface

The status and control ports of the Aurora 64B/66B core allow user applications to monitor the channel and use built-in features of the GTX and GTH transceivers. This section provides diagrams and port descriptions for the status and control interface, and the transceiver serial I/O interfaces.

### Status Control and Transceiver Ports

Table 2-11 describes the function of the Aurora 64B/66B core status and control ports allowing user applications to monitor the Aurora 64B/66B channel and access built-in features of the serial transceiver interface. The DRP interface allows reading and updating of the serial transceiver parameters and settings through the AXI4-Lite protocol-compliant or native dynamic reconfiguration port (DRP) interfaces.

Table 2-11: Transceiver Control and Status Interface Ports

Name	Direction	Clock Domain	Description
reset_pb/ tx_reset_pb/ rx_reset_pb	Input	async	Push Button Reset. The top-level reset input at the example design level. Required to drive the Support Reset logic inside the core. <ul style="list-style-type: none"> <li>• <i>reset_pb</i> is available in Duplex, TX-only_simplex and RX-only_simplex modes.</li> <li>• <i>tx_reset_pb</i> is available in TX/RX_simplex mode.</li> <li>• <i>rx_reset_pb</i> is available in TX/RX_simplex mode.</li> </ul>
gt_reset_out	Output	init_clk	Output of de-bouncer for gt_reset. Enabled when <b>Include Shared Logic in Core</b> is selected.
sys_reset_out/ tx_sys_reset_out/ rx_sys_reset_out	Output	user_clk	System reset output to be used by the example design level logic. <ul style="list-style-type: none"> <li>• <i>sys_reset_out</i> is available in Duplex, TX-only_simplex and RX-only_simplex modes.</li> <li>• <i>tx_sys_reset_out</i> is available in TX/RX_simplex mode.</li> <li>• <i>rx_sys_reset_out</i> is available in TX/RX_simplex mode.</li> </ul>
reset2fg	Output	user_clk	This port is used to reset the Frame generator in the example design only. <i>This port is available in the TX-only_Simplex and TX/RX_Simplex configurations only.</i>
reset2fc	Output	user_clk	This port is used to reset the Frame checker in the example design only. <i>This port is available in the RX-only_Simplex and TX/RX_Simplex configurations only.</i>
link_reset_out	Output	init_clk	Driven High if hot-plug count expires.
pma_init	Input	async	The transceiver pma_init reset signal is connected to the top level through a debouncer. Systematically resets all Physical Coding Sublayer (PCS) and Physical Medium Attachment (PMA) subcomponents of the transceiver. The signal is debounced using init_clk_in for at least six init_clk cycles. See the Reset section in the related transceiver user guide for more details.
<b>GT_SERIAL_RX</b>			
rxp[0:m-1] <sup>(1)</sup>	Input	RX serial clk	Positive differential serial data input pin. <i>This input is not available in the TX-only_simplex configuration.</i>
rxn[0:m-1] <sup>(1)</sup>	Input	RX serial clk	Negative differential serial data input pin. <i>This input is not available in the TX-only_simplex configuration.</i>

Table 2-11: Transceiver Control and Status Interface Ports (Cont'd)

Name	Direction	Clock Domain	Description
<b>GT_SERIAL_TX</b>			
txp[0:m-1] <sup>(1)</sup>	Output	TX serial clk	Positive differential serial data output pin. <i>This output is not available in the RX-only_simplex configuration.</i>
txn[0:m-1] <sup>(1)</sup>	Output	TX serial clk	Negative differential serial data output pin. <i>This output is not available in the RX-only_simplex configuration.</i>
<b>CORE_STATUS</b>			
channel_up/ tx_channel_up/ rx_channel_up	Output	user_clk	Asserted when the Aurora 64B/66B channel initialization is complete and the channel is ready to send/receive data. <ul style="list-style-type: none"> <li>channel_up is available in duplex mode.</li> <li>tx_channel_up is available in TX-only_simplex and TX/RX_simplex mode.</li> <li>rx_channel_up is available in RX-only_simplex and TX/RX_simplex mode.</li> </ul>
lane_up[0:m-1]/ tx_lane_up[0:m-1]/ rx_lane_up[0:m-1] <sup>(1)</sup>	Output	user_clk	Asserted for each lane upon successful lane initialization with each bit representing one lane. The Aurora 64B/66B core can only receive data after all lane_up signals are asserted. <ul style="list-style-type: none"> <li>lane_up is available in duplex mode.</li> <li>tx_lane_up is available in TX-only_simplex and TX/RX_simplex mode.</li> <li>rx_lane_up is available in RX-only_simplex and TX/RX_simplex mode.</li> </ul>
soft_err/ tx_soft_err/ rx_soft_err	Output	user_clk	Indicates that a soft error is detected in the incoming serial stream (asserted for a single user_clk period). <ul style="list-style-type: none"> <li>soft_err is available in duplex mode.</li> <li>tx_soft_err is available in TX-only_simplex and TX/RX_simplex mode.</li> <li>rx_soft_err is available in RX-only_simplex and TX/RX_simplex mode.</li> </ul>
hard_err/ tx_hard_err/ rx_hard_err	Output	user_clk	Hard error detected (asserted until the core resets). <ul style="list-style-type: none"> <li>hard_err is available in duplex mode.</li> <li>tx_hard_err is available in TX-only_simplex and TX/RX_simplex mode.</li> <li>rx_hard_err is available in RX-only_simplex and TX/RX_simplex mode.</li> </ul>
gt_to_common_qpllreset_out	Output	async	Quad phase-locked loop (QPLL) common reset output used by the slave partner shared logic.
gt_pll_lock	Output	init_clk	Asserted when tx_out_clk is stable. When deasserted (Low), circuits using tx_out_clk should be held in reset.

Table 2-11: Transceiver Control and Status Interface Ports (Cont'd)

Name	Direction	Clock Domain	Description
<b>CORE_CONTROL</b>			
loopback[2:0]	Input	async	See the 7 Series FPGAs GTX/GTH Transceivers User Guide (UG476) [Ref 7] or UltraScale Architecture GTH Transceivers User Guide (UG576) [Ref 5] or UltraScale Architecture GTY Transceivers User Guide (UG578) [Ref 6] for details about loopback.
gt_rxcdrovrden_in	Input	async	See the 7 Series FPGAs GTX/GTH Transceivers User Guide (UG476) [Ref 7] or UltraScale Architecture GTH Transceivers User Guide (UG576) [Ref 5] or UltraScale Architecture GTY Transceivers User Guide (UG578) [Ref 6] when applicable for details about gt_rxcdrovrden_in
power_down	Input	init_clk	Drives the Aurora 64B/66B core to reset.
<b>QPLL_CONTROL_IN</b>			
gt_qplllock_quad<quad_no>_in, gt_qpllrefclklost_quad<quad_no>_in <sup>(3)</sup>	Input	init_clk	QPLL lock and reference clock lost signal slave partner inputs. Should be connected to the master partner shared logic output ports gt_qplllock_quad<quad_no>_out and gt_qpllrefclklost_quad<quad_no>_out respectively.
<b>QPLL_CONTROL_OUT</b>			
gt_qplllock_quad<quad_no>_out, gt_qpllrefclklost_quad<quad_no>_out <sup>(3)</sup>	Output	init_clk	QPLL lock and reference clock lost signal master partner shared logic outputs.
<b>CHANNEL_DRP_IF<sup>(6)(17)(18)</sup></b>			
drp_clk_in	Input	-	A user-configurable parameter only applicable to 7 series FPGA designs. The default value is 100 MHz. The drp_clk frequency can be set from 50 MHz to x MHz where x is device and speed grade dependent. In UltraScale devices, init_clk is connected to the DRPCLK port of the GTHE3_CHANNEL DRP interface and in the axi_to_drp sub module.
drpaddr_in/ gt<lane>_drpaddr <sup>(14)(8)</sup>	Input	drp_clk_in	DRP address bus. The drpaddress bus is available on a per lane basis.
drpdi_in/ gt<lane>_drpdi <sup>(14)(8)</sup>	Input	drp_clk_in	Data bus for reading configuration data from the transceiver to the FPGA logic resources. The DRP data input bus is available on a per lane basis.

Table 2-11: Transceiver Control and Status Interface Ports (Cont'd)

Name	Direction	Clock Domain	Description
drpen_in_lane_<lane>/ gt<lane>_drpen <sup>(14)(8)</sup>	Input	drp_clk_in	DRP enable signal. <b>0</b> : No read or write operation performed. <b>1</b> : Enables a read or write operation. For write operations, drpwe and drpen should be driven High concurrently for one drp_clk_in cycle only. For read operations, drpen should be driven High for one drp_clk_in cycle. The DRP enable is available on a per lane basis.
drpwe_in_lane_<lane>/ gt<lane>_drpwe <sup>(8)(14)</sup>	Input	drp_clk_in	DRP write enable. <b>0</b> : Read operation when drpen is 1. <b>1</b> : Write operation when drpen is 1. For write operations, drpwe and drpen should be driven High for one drpclk cycle only. The DRP write enable is available on a per lane basis.
drpdo_out_lane_<lane>/ gt<lane>_drpdo <sup>(8)(14)</sup>	Output	drp_clk_in	Data bus for reading configuration data from the GTX or GTH transceiver to the FPGA logic resources. The DRP data out bus is available on a per lane basis.
drprdy_out_lane_<lane>/ gt<lane>_drprdy <sup>(8)(14)</sup>	Output	drp_clk_in	Indicates that the write operation is complete and read data is valid. The drprdy signal is available on a per lane basis.
<b>AXILITE_DRP_IF<sup>(6)</sup></b>			
s_axi_awaddr_lane_<lane_no> <sup>(2)(9)</sup>	Input	drp_clk_in	AXI4-Lite Write address for DRP.
s_axi_awvalid_lane_<lane_no> <sup>(2)(9)</sup>	Input	drp_clk_in	Write address valid.
s_axi_awready_lane_<lane_no> <sup>(2)(9)</sup>	Output	drp_clk_in	Write address ready.
s_axi_araddr_lane_<lane_no> <sup>(2)(9)</sup>	Input	drp_clk_in	AXI4-Lite Read address for DRP.
s_axi_arvalid_lane_<lane_no> <sup>(2)(9)</sup>	Input	drp_clk_in	Read address valid.
s_axi_arready_lane_<lane_no> <sup>(2)(9)</sup>	Output	drp_clk_in	Read address ready.
s_axi_wdata_lane_<lane_no> <sup>(2)(9)</sup>	Input	drp_clk_in	Write data for DRP.
s_axi_wvalid_lane_<lane_no> <sup>(2)(9)</sup>	Input	drp_clk_in	Write data valid.
s_axi_wready_lane_<lane_no> <sup>(2)(9)</sup>	Output	drp_clk_in	Write data ready.
s_axi_wstrb_lane_<lane_no> <sup>(2)(9)</sup>	Input	drp_clk_in	Write data strobe.



Table 2-11: Transceiver Control and Status Interface Ports (Cont'd)

Name	Direction	Clock Domain	Description
s_axi_bvalid_lane_<lane_no> <sup>(2)(9)</sup>	Output	drp_clk_in	Write response valid.
s_axi_bresp_lane_<lane_no> <sup>(2)(9)</sup>	Output	drp_clk_in	Write response.
s_axi_rdata_lane_<lane_no> <sup>(2)(9)</sup>	Output	drp_clk_in	Read data.
s_axi_rvalid_lane_<lane_no> <sup>(2)(9)</sup>	Output	drp_clk_in	Read data valid.
s_axi_rresp_lane_<lane_no> <sup>(2)(9)</sup>	Output	drp_clk_in	Read response.
s_axi_rready_lane_<lane_no> <sup>(2)(9)</sup>	Output	drp_clk_in	Read data ready.
s_axi_bready_lane_<lane_no> <sup>(2)(9)</sup>	Input	drp_clk_in	Write data ready.
<b>TRANSCEIVER_DEBUG<sup>(11)</sup></b>			
gt<lane>_cplllock_out/ gt_cplllock <sup>(4)(5)(10)(14)</sup>	Output	init_clk	Active-High PLL frequency lock signal indicating that PLL frequency is within the predetermined tolerance. The transceiver and its clock outputs are not reliable until this condition is met.
gt<lane>_dmonitorout_out[j:0]/ gt_dmonitorout <sup>(4)(5)(10)(12)(14)</sup>	Output	async	Digital Monitor Output Bus. j = 7 for GTX transceivers. j = 14 for GTH transceivers.
gt<lane>_eyescaerror_out/ gt_eyescaerror <sup>(4)(5)(10)(12)(14)</sup>	Output	async	Asserted High for one rec_clk cycle when an (unmasked) error occurs while in the COUNT or ARMED state.
gt<lane>_eyescareset_in/ gt_eyescareset <sup>(4)(5)(10)(12)(14)</sup>	Input	async	Driven High, then deasserted to start the EYESCAN reset process.
gt<lane>_eyescareset_in/ gt_eyescareset <sup>(4)(5)(10)(12)(14)</sup>	Input	user_clk	Causes a trigger event.
gt_pcsrsvdin <sup>(4)(10)(11)(13)(14)</sup>	Input	async	PCSRVDIN[2] is the DRP reset pin. For read-only registers, if a DRPRDY is not seen within 500 DRPCLK cycles after initiating a DRP transaction, reset the DRP interface using the port PCSRVDIN[2]. This is available only in UltraScale device-based designs
gt<lane>_rxbufreset_in/ gt_rxbufreset <sup>(4)(5)(10)(12)(14)</sup>	Input	async	Driven High, then deasserted to start the RX elastic buffer reset process. In either single or sequential mode, activating rxbufreset resets the RX elastic buffer only.

Table 2-11: Transceiver Control and Status Interface Ports (Cont'd)

Name	Direction	Clock Domain	Description
gt<lane>_rxbufstatus_out/ gt_rxbufstatus <sup>(4)(5)(10)(12)(14)</sup>	Output	rxoutclk	RX buffer status. <b>000b</b> : Nominal condition. <b>001b</b> : Number of bytes in the buffer are less than CLK_COR_MIN_LAT. <b>010b</b> : Number of bytes in the buffer are greater than CLK_COR_MAX_LAT. <b>101b</b> : RX elastic buffer underflow. <b>110b</b> : RX elastic buffer overflow.
gt<lane>_rxcdrhold_in/ gt_rxcdrhold <sup>(4)(5)(10)(12)(14)</sup>	Input	async	Holds the clock data recovery (CDR) control loop frozen.
gt<lane>_rxdfefagchold_in <sup>(5)(10)(12)(13)(14)</sup>	Input	rxoutclk	HOLD RX DFE (Decision Feedback Equalizer) <b>2'b00</b> : Automatic gain control (AGC) loop adapt. <b>2'b10</b> : Freeze current AGC adapt value. <b>2'bx1</b> : Override AGC value according to the attribute. RX_DFE_GAIN_CFG
gt<lane>_rxdfefagcovrden_in <sup>(5)(10)(12)(13)(14)</sup>	Input	rxoutclk	OVRDEN RX DFE <b>2'b00</b> : Automatic gain control (AGC) loop adapt. <b>2'b10</b> : Freeze current AGC adapt value. <b>2'bx1</b> : Override AGC value according to attribute. RX_DFE_GAIN_CFG
gt<lane>_rxdfelfhold_in <sup>(5)(10)(12)(13)(14)</sup>	Input	rxoutclk	When set to 1'b1, the current low-frequency boost value is held. When set to 1'b0, the low-frequency boost is adapted.
gt<lane>_rxdfelpmreset_in/ gt_rxdfelpmreset <sup>(4)(5)(10)(12)(14)</sup>	Input	async	Driven High, then deasserted to start the DFE reset process.
gt<lane>_rxlpmen_in/ gt_rxplmen <sup>(4)(5)(10)(12)(14)</sup>	Input	async	RX datapath <b>0</b> : DFE <b>1</b> : LPM (Low Power Mode)
gt<lane>_rxlpmhfovrden_in <sup>(5)(10)(12)(13)(14)</sup>	Input	rxoutclk	OVRDEN RX LPM <b>2'b00</b> : KH high frequency loop adapt value. <b>2'b10</b> : Freeze current adapt value. <b>2'bx1</b> : Override KH value according to the RXLPM_HF_CFG attribute.
gt<lane>_rxlpmflkloverden_in <sup>(5)(10)(12)(13)(14)</sup>	Input	rxoutclk	OVRDEN RX LPM <b>2'b00</b> : KL low frequency loop adapt value. <b>2'b10</b> : Freeze current adapt value. <b>2'bx1</b> : Override KL value according to the RXLPM_LF_CFG attribute.

Table 2-11: Transceiver Control and Status Interface Ports (Cont'd)

Name	Direction	Clock Domain	Description
gt<lane>_rxmonitorout_out(5)(10)(12)(13)(14)	Output	async	GTX transceiver: <ul style="list-style-type: none"> <li>• RXDFEVP[6:0] = RXMONITOROUT[6:0]</li> <li>• RXDFEUT[6:0] = RXMONITOROUT[6:0]</li> <li>• RXDFEAGC[4:0] = RXMONITOROUT[4:0]</li> </ul> GTH transceiver: <ul style="list-style-type: none"> <li>• RXDFEVP[6:0] = RXMONITOROUT[6:0]</li> <li>• RXDFEUT[6:0] = RXMONITOROUT[6:0]</li> <li>• RXDFEAGC[3:0] = RXMONITOROUT[4:1]</li> </ul>
gt<lane>_rxmonitorsel_in(5)(10)(12)(13)(14)	Input	async	Select signal for rxmonitorout[6:0] <ul style="list-style-type: none"> <li>2'b00: Reserved.</li> <li>2'b01: Select AGC loop.</li> <li>2'b10: Select UT loop.</li> <li>2'b11: Select VP loop.</li> </ul>
gt<lane>_rxpcsreset_in/ gt_rxpcsreset(4)(5)(10)(12)(14)	Input	async	Driven High, then deasserted to start the RX PMA reset process. The rxpcsreset signal does not start the reset process until rxuserddy is High.
gt<lane>_rxpmareset_in/ gt_rxpmareset(4)(5)(10)(12)(14)	Input	async	Driven High, then deasserted to start the RX PMA reset process.
gt<lane>_rxpmaresetdone_out/ gt_rxpmaresetdone(4)(5)(10)(12)(14)	Output	async	Indicates that the RX PMA reset is complete. Driven Low when GTRXRESET or RXPMARESET is asserted. Available for duplex and RX-only simplex configurations. <i>Available only with GTH transceivers.</i>
gt<lane>_rxprbscntreset_in/ gt_rxprbscntreset(4)(5)(10)(12)(14)	Input	rxoutclk	Resets the PRBS error counter.
gt<lane>_rxprbserr_out/ gt_rxprbserr(4)(5)(10)(12)(14)	Output	rxoutclk	Non-sticky status output indicates that PRBS errors have occurred.
gt<lane>_rxprbssel_in/ gt_rxprbssel(4)(5)(10)(12)(14)	Input	rxoutclk	Receiver PRBS checker test pattern control. Valid settings: <ul style="list-style-type: none"> <li>000: Standard operation (PRBS check off).</li> <li>001: PRBS-7.</li> <li>010: PRBS-15.</li> <li>011: PRBS-23.</li> <li>100: PRBS-31.</li> </ul> No checking is done for non-PRBS patterns. Single-bit errors cause bursts of PRBS errors because the PRBS checker uses data from the current cycle to generate expected data for the next cycle.
gt_rxrate(4)(10)(12)	Input	rxoutclk	Dynamic pins to automatically change effective PLL dividers in the GTH transceiver RX. These ports are used for PCI Express® and other standards. Available only with UltraScale FPGAs.

Table 2-11: Transceiver Control and Status Interface Ports (Cont'd)

Name	Direction	Clock Domain	Description
gt<lane>_rxresetdone_out/ gt_rxresetdone <sup>(4)(5)(10)(12)(14)</sup>	Output	rxoutclk	When asserted, indicates the GTX/GTH transceiver RX has finished reset and is ready for use. Driven Low when gtrxreset is driven High. Not driven High until rxuserddy goes High.
gt<lane>_txbufstatus_out/ gt_txbufstatus <sup>(4)(5)(10)(11)(14)</sup>	Output	user_clk	<b>txbufstatus [1]</b> : TX buffer overflow or underflow status. When txbufstatus[1] is set High, the signal remains High until the TX buffer is reset. <b>1</b> : TX FIFO has overflow or underflow. <b>0</b> : No TX FIFO overflow or underflow error. <b>txbufstatus [0]</b> : TX buffer fullness. <b>1</b> : TX FIFO is at least half full. <b>0</b> : TX FIFO is less than half full.
gt<lane>_txdiffctrl_in/ gt_txdiffctrl <sup>(4)(5)(10)(11)(14)</sup>	Input	async	Driver Swing Control. Available for duplex and TX-only simplex configurations.
gt<lane>_txinhibit_in/gt_txinhibit <sup>(4)(5)(10)(11)(14)</sup>	Input	user_clk	When High, this signal blocks transmission of TXDATA and forces the serial data output pin TXP to 0 and TXN to 1.
gt<lane>_txmaincursor_in <sup>(5)(10)(11)(13)(14)</sup>	Input	async	Allows the main cursor coefficients to be set directly if the TX_MAINCURSOR_SEL attribute is set to 1'b1.
gt<lane>_txpcsreset_in/ gt_txpcsreset <sup>(4)(5)(10)(11)(14)</sup>	Input	async	Resets the TX PCS. Driven High, then deasserted to start the PCS reset process. Activating this port only resets the TX PCS.
gt<lane>_txpmareset_in/ gt_txpmareset <sup>(4)(5)(10)(11)(14)</sup>	Input	async	Resets the TX PMA. Driven High, then deasserted to start the TX PMA reset process. Activating this port resets both the TX PMA and the TX PCS.
gt<lane>_txpolarity_in/ gt_txpolarity <sup>(4)(5)(10)(11)(14)</sup>	Input	user_clk	Inverts the polarity of outgoing data. <b>0</b> : Not inverted. TXP is positive, and TXN is negative. <b>1</b> : Inverted. TXP is negative, and TXN is positive.
gt<lane>_txpostcursor_in/ gt_txpostcursor <sup>(4)(5)(10)(11)(14)</sup>	Input	async	Transmitter post-cursor TX pre-emphasis control.
gt<lane>_txprbsforceerr_in/ gt_txprbsforceerr <sup>(4)(5)(10)(11)(14)</sup>	Input	user_clk	When driven High, errors are forced into the PRBS transmitter. While asserted, the output data pattern contains errors. When txprbsel is set to 000, this port does not affect TXDATA.

Table 2-11: Transceiver Control and Status Interface Ports (Cont'd)

Name	Direction	Clock Domain	Description
gt<lane>_txprbsel_in/ gt_txprbsel <sup>(4)(5)(10)(11)(14)</sup>	Input	user_clk	Transmitter PRBS generator test pattern control. For 7 series devices: <b>000</b> : Standard mode (pattern generation off). <b>001</b> : PRBS-7. <b>010</b> : PRBS-15. <b>011</b> : PRBS-23. <b>100</b> : PRBS-31. <b>101</b> : PCI Express compliance pattern. Only works with 20-bit and 40-bit modes. <b>110</b> : Square wave with 2 UI (alternating 0s/1s). <b>111</b> : Square wave with 16 UI, 20 UI, 32 UI, or 40 UI period (based on data width). For UltraScale devices: <b>4'b0000</b> : Standard mode (pattern generation off). <b>4'b0001</b> : PRBS-7. <b>4'b0010</b> : PRBS-9. <b>4'b0011</b> : PRBS-15. <b>4'b0100</b> : PRBS-23. <b>4'b0101</b> : PRBS-31. <b>4'b1000</b> : PCI Express compliance pattern. Only works with internal data width 20 bit and 40 bit modes. <b>4'b1001</b> : Square wave with 2 UI (alternating 0s/1s). <b>4'b1010</b> : Square wave with 16 UI, 20 UI, 32 UI, or 40 UI period (based on internal data width).
gt<lane>_txprecursor_in/ gt_txprecursor <sup>(4)(5)(10)(11)(14)</sup>	Input	async	Transmitter pre-cursor TX pre-emphasis control.
gt<lane>_txresetdone_out/ gt_txresetdone <sup>(4)(5)(10)(11)(14)</sup>	Output	user_clk	Indicates the GTX/GTH transceiver TX has finished reset and is ready for use. Driven Low when gtxreset goes High and not driven High until the GTX/GTH transceiver TX detects txuserdy High.

Table 2-11: Transceiver Control and Status Interface Ports (Cont'd)

Name	Direction	Clock Domain	Description
gt_qplllock_quad<quad_no>/ gt_qplllock <sup>(3)(4)(5)(11)(10)</sup>	Output	init_clk	Active-High PLL frequency lock signal. Indicates that the PLL frequency is within predetermined tolerance. The transceiver and its clock outputs are not reliable until this condition is met.

**Notes:**

1. *m* is the number of GTX or GTH transceivers.
2. *lane\_no* varies from 1 to (number of lanes –1).
3. In 7 series FPGAs, *quad\_no* varies from 1 to (number of active transceiver quads –1). In UltraScale FPGAs, *quad\_no* varies from 1 to the number of active transceiver quads.
4. Refer to the *UltraScale FPGAs GTH Transceivers User Guide* (UG576) [Ref 5] or *UltraScale Architecture GTY Transceivers User Guide* (UG578) [Ref 6] for more information about debug ports.
5. Refer to the *7 series FPGAs Transceivers User Guide* (UG476) [Ref 7] for more information about debug ports.
6. In UltraScale devices, all DRP and AXI4-Lite ports are sampled on *init\_clk*.
7. The Transceiver\_Debug ports are enabled if the **Additional transceiver control and status ports** option is selected in the Debug and Control section of the Vivado Integrated Design Environment (IDE) Core Options page. For designs using UltraScale devices, the prefixes of the optional transceiver debug ports for single-lane cores are changed from *gt<lane>* to *gt*, and the postfixes *\_in* and *\_out* are removed. For multi-lane cores, the prefixes of the optional transceiver debug ports *gt(n)* are aggregated into a single port.
8. This port is available if the **Native** option is selected in the DRP Mode section of the Vivado IDE Core Options page.
9. This port is available if the **AXI4LITE** option is selected in the DRP Mode section of the Vivado IDE Core Options page.
10. This port is available if the **Additional transceiver control and status ports** option is selected in the DRP Mode section of the Vivado IDE Core Options page.
11. Available for duplex, TX-Only simplex and TX/RX\_simplex configurations.
12. Available for duplex, RX-Only simplex and TX/RX\_simplex configurations.
13. Not available with UltraScale devices.
14. *lane* varies from 0 to (number of lanes –1).
15. *quad* varies from 0 to (number of active transceiver quads –1).
16. Not available in 7 series devices.
17. Refer to the relevant UG Transceiver guide for more information on DRP ports.
18. For GT Channel DRP access you can either select the AXI4-Lite interface or the native interface.
19. GT Common DRP access is not supported.



**IMPORTANT:** *The ports in the Transceiver Control and Status interface must be driven in accordance with the appropriate GT user guide. Using the input signals listed in Table 2-11 improperly might result in unpredictable behavior of the IP core.*

Figure 2-31 shows the status and control interface for an Aurora 64B/66B duplex core.

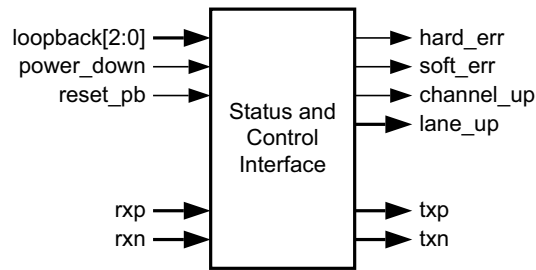

Figure 2-31: Aurora 64B/66B Duplex Status and Control Interface

Figure 2-32 shows the status and control interface for an Aurora 64B/66B TX-only simplex core.

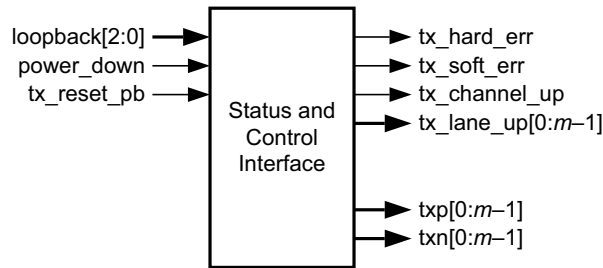

Figure 2-32: Aurora 64B/66B TX-Only Simplex Status and Control Interface

Figure 2-33 shows the status and control interface for an Aurora 64B/66B RX-only simplex core.

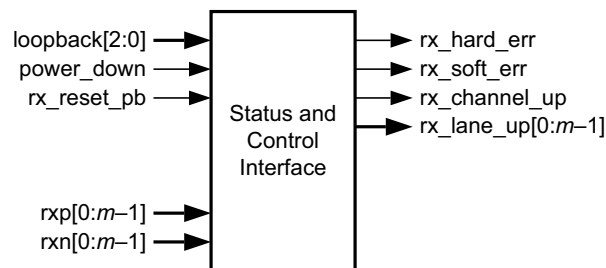

Figure 2-33: Aurora 64B/66B RX-Only Simplex Status and Control Interface

Figure 2-34 shows the status and control interface for an Aurora 64B/66B TX/RX Simplex core.

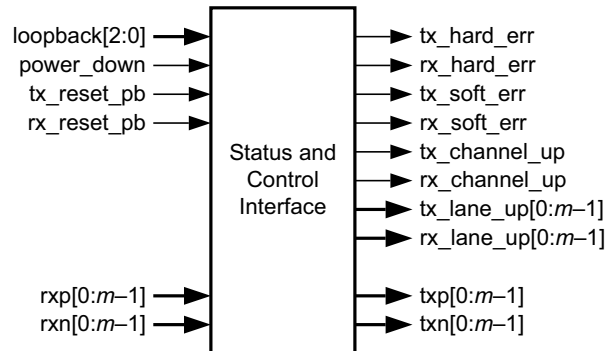

Figure 2-34: Aurora 64B/66B TX/RX Simplex Status and Control Interface

### Error Signals in Aurora 64B/66B Cores

Equipment problems and channel noise can cause errors during Aurora 64B/66B channel operation. The 64B/66B encoding method allows the Aurora 64B/66B core to detect some bit errors that can occur in the channel. The core reports these errors by asserting the `soft_err` signal on every cycle in which they are detected.

The core also monitors each high-speed serial GTX and GTH transceiver for hardware errors such as buffer overflow and loss of lock. Hardware errors are reported by asserting the `hard_err` signal. Catastrophic hardware errors can also manifest themselves as a burst of soft errors. The Block Sync algorithm described in the *Aurora 64B/66B Protocol Specification v1.3* (SP011) [Ref 9] determines whether to treat a burst of soft errors as a hard error.

Whenever a hard error is detected, the core automatically resets itself and attempts to re-initialize. In most cases, this permits reestablishing the Aurora 64B/66B channel when the hardware issue causing the hard error is resolved. Soft errors do not lead to a reset unless enough occur in a short period of time to trigger the block sync state machine.

Table 2-12 describes the core error signals.

Table 2-12: Aurora 64B/66B Core Error Signals

Signal	Description	TX	RX
hard_err	<b>TX Overflow/Underflow:</b> An overflow or underflow condition exists in the TX data elastic buffer. This condition can occur when the user clock and the reference clock sources are not operating at the same frequency.	X	
	<b>RX Overflow/Underflow:</b> An overflow or underflow condition exists in the RX data clock correction and channel bonding FIFO. This condition can occur when the clock source frequencies for the two channel partners are not within $\pm 100$ ppm.		X

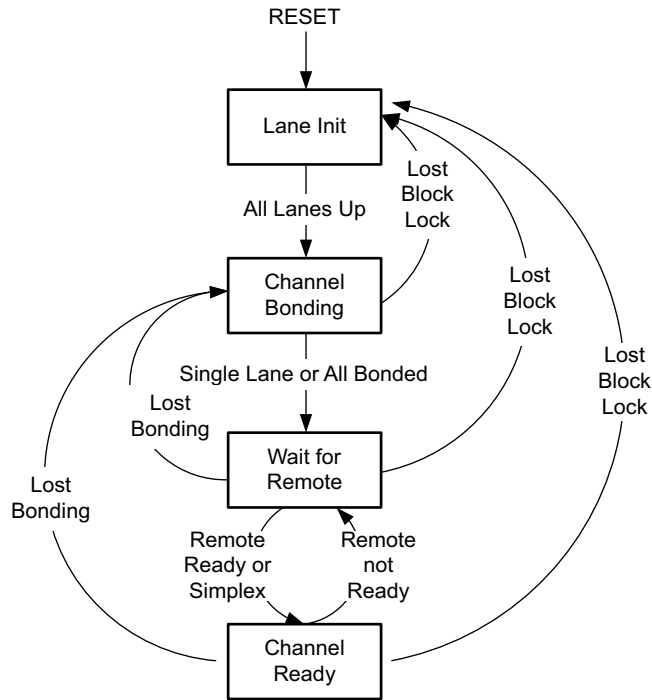

Table 2-12: Aurora 64B/66B Core Error Signals (Cont'd)

Signal	Description	TX	RX
soft_err	<b>Soft Errors:</b> Too many soft errors occurred within a short period of time. The alignment block sync state machine automatically attempts to realign if too many invalid sync headers are detected. Soft errors are not transformed into hard errors.		X
	<b>Invalid SYNC Header:</b> The 2-bit header on the 64-bit block was not a valid control or data header.		X
	<b>Invalid BTF:</b> The block type field (BTF) of a received control block contained an unrecognized value. This condition usually results from a bit error.		X

### Initialization

The cores initialize automatically after power-up, reset, or hard error (Figure 2-35). Core modules on each side of the channel perform the Aurora 64B/66B initialization procedure until the channel is ready for use. The lane\_up bus indicates which lanes in the channel have finished the lane initialization portion of the procedure. The lane\_up signal can be used to help debug equipment problems in a multi-lane channel. channel\_up is asserted only after the core completes the entire initialization procedure.



X13040

Figure 2-35: Initialization Overview

Aurora 64B/66B cores can receive data before `channel_up` is asserted. Only the user interface `m_axi_rx_tvalid` signal should be used to qualify incoming data. Because no transmission can occur until after `channel_up` is asserted, `channel_up` can be inverted and used to reset modules that drive the TX side of a full-duplex channel. If user application modules need to be reset before data reception, an inverted `lane_up` signal can be used for this purpose. Data cannot be received until all of the `lane_up` signals are asserted.

### ***Aurora 64B/66B Simplex Operation***

Simplex Aurora 64B/66B cores have no sideband connection and use timers to declare that the partner is out of initialization and, thus, ready for data transfer. Simplex TX/RX cores have both transmit and receive portions of the transceiver configured to operate independently. However, the simplex TX/RX cores have reset and `pma_init` signals in common between the transmit and receive path of the core.

The `BACKWARD_COMP_MODE3 TX/RX_simplex` core parameter can be used to prevent unintentional hot plug events from inhibiting channel up assertion. This parameter is available in the `<user_component_name>_core.v` file and is available for all core configurations.

- `BACKWARD_COMP_MODE3 = 0` clears the hot plug counter only on reception of CC characters
- `BACKWARD_COMP_MODE3 = 1` clears the hot plug counter on reception of any valid BTF characters



---

**RECOMMENDED:** *Follow the reset sequence given in Chapter 3.*

---

### ***Auto Link Recovery for Simplex***

The simplex Aurora 64b/66b core must follow a predefined reset sequence for the simplex cores to link up and work as expected. The simplex TX core needs to be in reset or should keep sending initialization sequences until the RX side is up.

The simplex auto link recovery feature in the core eliminates this requirement, thereby removing any reset sequence requirement between simplex TX and simplex RX cores.

Auto Link Recovery in Aurora 64b/66b simplex designs is based on the reception of Channel Bonding (CB) patterns. Reception of the pattern allows the RX simplex core to come up independently of the TX Simplex core bring-up. The parameter `PERIODIC_CB_COUNT` denotes in `user_clk` cycles the time from the start of one periodic CB pattern to the start of the next successive CB pattern. The minimum value is 6,080. The maximum value is 163,839. The periodic CB pattern includes transmission of CB-IDLE patterns with the appropriate spacing to help the receiver achieves channel up even if the link was down for some reason. Typically, these CB-IDLE patterns take up to 600 user-clk cycles. Spacing of these patterns are chosen to match the throughput of the earlier released core versions which were transmitting a Single CB character periodically.

Bandwidth occupancy = No. of user\_clk cycles required by CB pattern/ Total no. of user\_clk cycles)\*100.

You can increase the count based on the following formula:

$$\text{PERIODIC\_CB\_COUNT} = \text{Minimum} \{1048570, \text{INTEGER part of } \lceil \frac{16777215 * \text{INIT\_CLK\_PERIOD}}{4 * \text{USER\_CLK\_PERIOD}} \rceil \}$$

where,

INIT\_CLK\_PERIOD is `init_clk` time-period in ns

USER\_CLK\_PERIOD is `user_clk` time-period in ns.



---

**IMPORTANT:** Xilinx highly recommends that the maximum value be fixed at 163,839 and a change in the value should be performed with careful analysis and testing.

---

## DRP Interface

The DRP interface allows user applications to monitor and modify the transceiver status. The native interface provides the native transceiver DRP interface ports. The AXI4-Lite interface (fully compliant with the AXI4-Lite protocol) is the default interface.

For native DRP sequences, the read and write operations are as specified in the respective FPGA Transceivers User Guides. For AXI4-Lite DRP sequences, the read and write operations from the user interface are specified in the AXI4-Lite protocol. The Aurora 64B/66B core does not use the `wstrb` signal (refer to the *Vivado AXI Reference Guide*, (UG1037) [Ref 10]). The `axi_to_drp` module is used to translate between the transceiver DRP and AXI4-Lite protocols.

## Transceiver Debug Interface

Figure 2-36 and Figure 2-37 show the additional available transceiver debugging control and status ports when the TRANSCEIVER\_DEBUG interface is selected for 7 series and UltraScale devices, respectively.

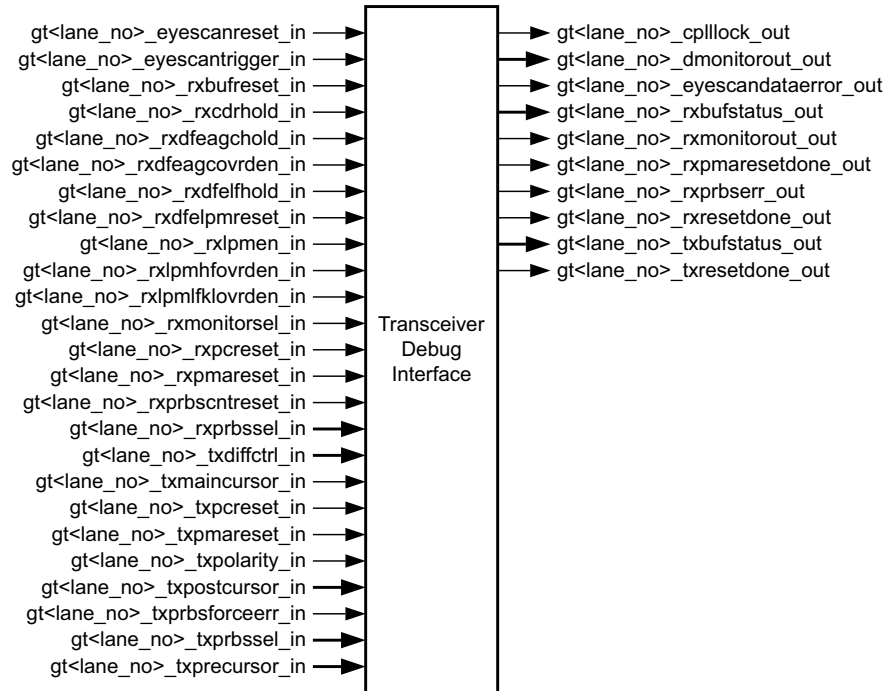

Figure 2-36: 7 Series Devices Transceiver Debug Interface Ports

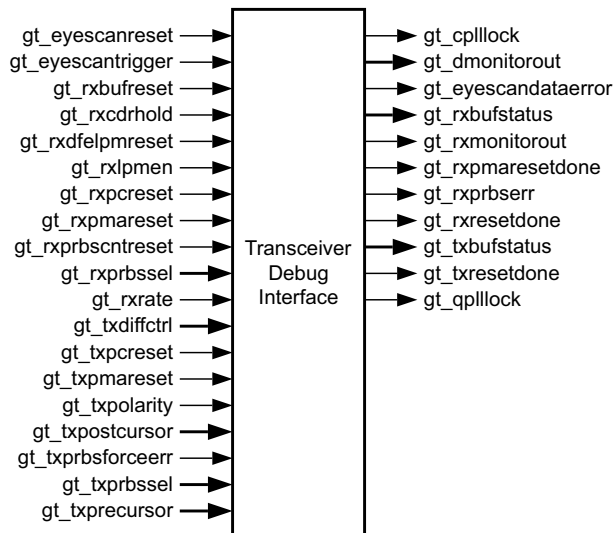

Figure 2-37: UltraScale Devices Transceiver Debug Interface Ports

## CRC Interface

CRC is an optional interface. The `crc_valid` and `crc_pass_fail_n` signals (Table 2-13) indicate the result of a received frame transmitted with CRC. See [Using CRC](#) for more information.

Table 2-13: CRC Interface Ports

Name	Direction	Clock Domain	Description
<b>CORE_STATUS</b>			
crc_valid	Output	user_clk	Samples the crc_pass_fail_n signal.
crc_pass_fail_n	Output	user_clk	The crc_pass_fail_n signal is asserted High when the received CRC matches the transmitted CRC. This signal is not asserted if the received CRC is not equal to the transmitted CRC. The crc_pass_fail_n signal should always be sampled with the crc_valid signal.

Figure 2-38 illustrates checking CRC at the core level. The figure shows  $6n$  bytes of received data of a frame. At the end of the frame, the core asserts `m_axi_rx_tlast` and `crc_valid`. In the same clock cycle the transmitted and computed CRCs are compared. If the values match, the `crc_pass_fail_n` signal is asserted.

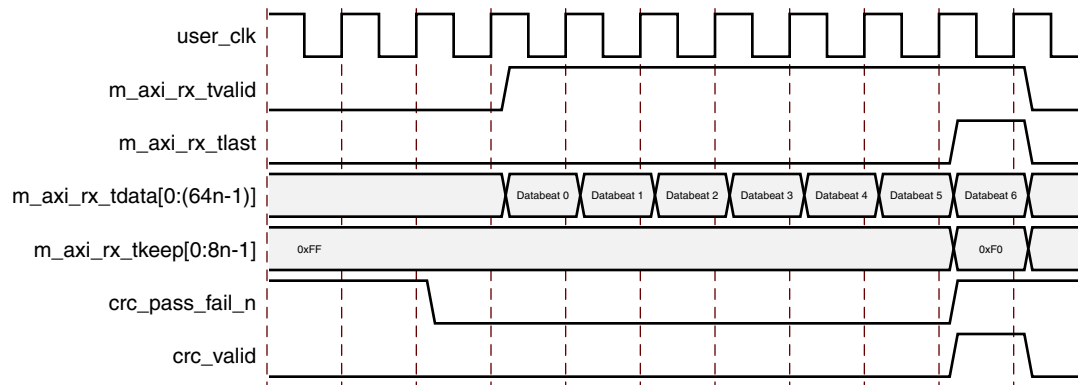

Figure 2-38: A  $6n$  Data Beats Frame with CRC

### CRC Functionality for a GTY Transceiver Based Core

CRC functionality is backward compatible for the line rates between 0.5 Gb/s and 16.375 Gb/s. For the line rates between 16.375 Gb/s and 25.7813 Gb/s, the CRC functionality is modified on a per lane basis to meet the stringent timing requirements at higher line rates. However, the user interface through `crc_pass_fail_n` and `crc_valid` signals carry the same meaning as that of other line rates of less than 16.375 Gb/s.

# Designing with the Core

This chapter includes guidelines and additional information to facilitate designing with the core.

---

## General Design Guidelines

All Aurora 64B/66B core implementations require careful attention to system performance requirements. Pipelining, logic mappings, placement constraints, and logic duplications are all methods that help boost system performance.

### Keep It Registered

To simplify timing and increase system performance in an FPGA design, keep all inputs and outputs registered with a flip-flop between the user application and the core. While registering signals might not be possible for all paths, it simplifies timing analysis and makes it easier for the Xilinx tools to place-and-route the design.

### Recognize Timing Critical Signals

The XDC file provided with the example design for the core identifies the critical signals and the timing constraints that should be applied.

### Make Only Allowed Modifications

The Aurora 64B/66B core is not user modifiable. Any modifications might have adverse effects on the system timings and protocol compliance. Supported user configurations of the Aurora 64B/66B core can only be made by selecting options from the IP catalog.

---

## Clocking

Good clocking is critical for the correct operation of the Aurora 64B/66B core. The core requires a low-jitter reference clock to drive the high-speed TX clock and clock recovery circuits in the GTX or GTH transceiver. The core also requires at least one frequency-locked parallel clock for synchronous operation with the user application.

Each Aurora 64B/66B core is generated in the `example_project` directory which includes a design called `aurora_example`. This design instantiates the generated core and demonstrates a working clock configuration for the core. First-time users should examine the Aurora 64B/66B example design for use as a template when connecting the clock interface.

## Aurora 64B/66B Clocking Architecture

Figure 3-1 shows the clocking architecture in the Aurora 64B/66B core for GTX or GTH transceivers.

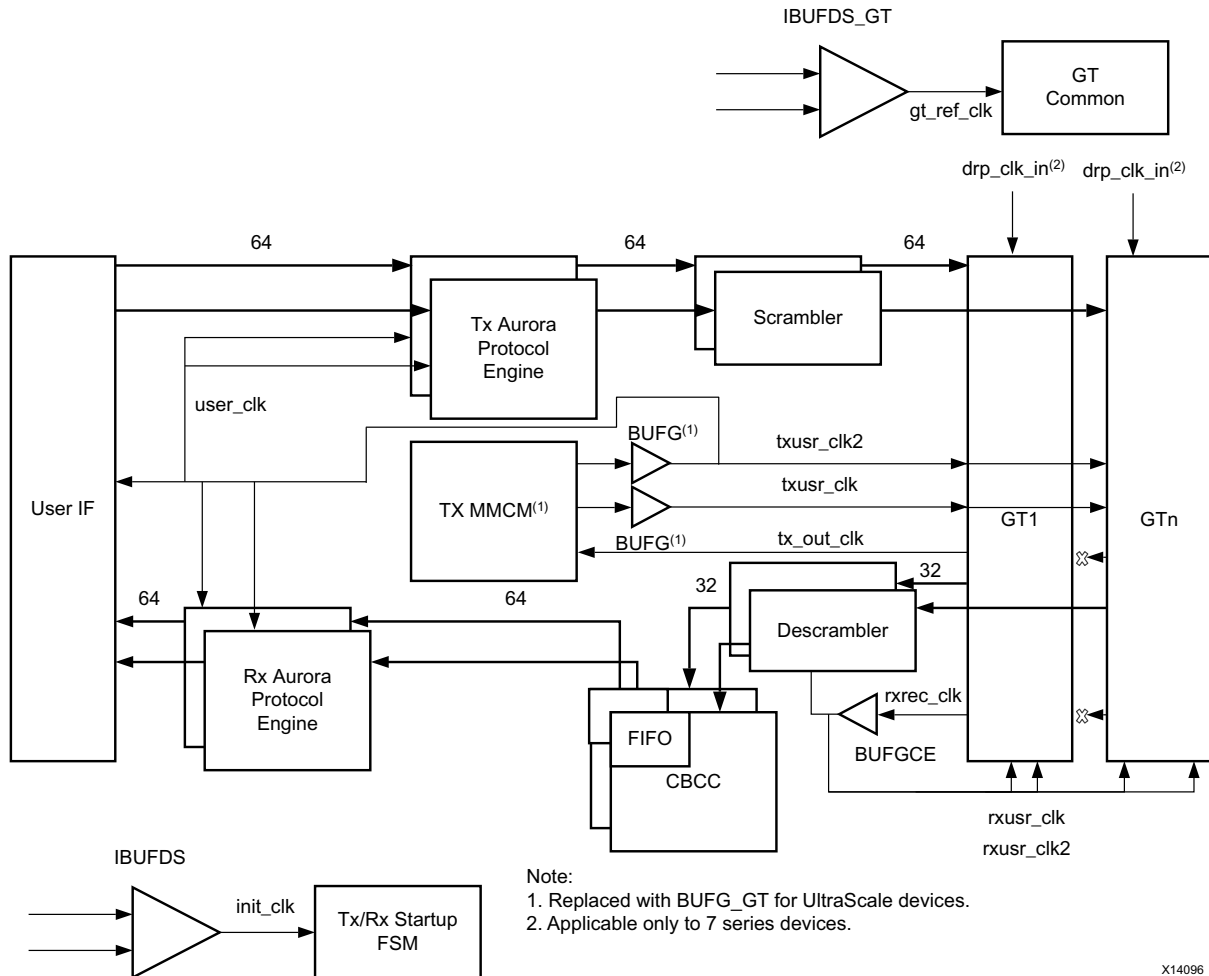

Figure 3-1: Aurora 64B/66B Clocking for GTX or GTH Transceivers

The following paragraphs describe connecting `user_clk`, `sync_clk`, and `tx_out_clk`.

The Aurora 64B/66B cores use three phase-locked parallel clocks. The first is `user_clk`, which synchronizes all signals between the core and the user application. All logic touching the core must be driven by `user_clk`, which in turn must be the output of a global clock buffer (BUFG).

The `user_clk` signal is used to drive the `txusrclk2` port of the serial transceiver. The `tx_out_clk` is selected such that the data rate of the parallel side of the module matches the data rate of the serial side of the module, taking into account 64B/66B encoding and decoding.



The third phase-locked parallel clock is `sync_clk`. This clock must also come from a BUFG and is used to drive `txusrclk` port of the serial transceiver. It is also connected to the Aurora 64B/66B core to drive the internal synchronization logic of the serial transceiver.

To make it easier to use the two parallel clocks, a clock module is provided in a subdirectory called `clock_module` under `example_design/support` or under `src` based on shared logic settings. The ports for this module are described in [Table 2-11](#). If the clock module is used, the `mmcm_not_locked` signal should be connected to the `mmcm_not_locked` output of the clock module; `tx_out_clk` should connect to the clock module `clk` port, and `pll_lock` should connect to the clock module `pll_not_locked` port. If the clock module is not used, connect the `mmcm_not_locked` signal to the inverse of the `locked` signal from any PLL used to generate either of the parallel clocks, and use the `pll_lock` signal to hold the PLLs in reset during stabilization if `tx_out_clk` is used as the PLL source clock. The `txusrclk` could be unreliable during assertion of `pma_init`; hence, the core uses a stable clock (`init_clk`) for MMCM synchronization. Using a stable clock to sample adds more robustness to the link.

If MMCM is used to generate a stable clock (`init_clk`), `pma_init` needs to be applied to the Aurora 64B/66B core until MMCM lock is established. This ensures that the core remains in a known state before a stable clock is available for the core.

## Usage of BUFG in the Aurora 64B/66B Core

The Aurora 64B/66B core uses four BUFGs as shown in [Figure 3-1](#) for a given core configuration using GTX or GTH transceivers. Aurora 64B/66B is an eight-byte-aligned protocol, and the datapath from the user interface is 8-bytes aligned. For GTX or GTH transceivers, the core configures the transmit path as eight bytes and the receive path as four bytes.

The CB/CC logic is internal to the core, which is primarily based on the received recovered clock from the serial transceiver. The BUFG usage is constant for any core configuration and does not increase with any core feature.

## Reference Clocks for FPGA Designs

Aurora 64B/66B cores require low-jitter reference clocks for generating and recovering high-speed serial clocks in the GTX and GTH transceivers. Each reference clock can be set to the reference clock input ports: `gtxq/gthq`. Reference clocks should be driven with high-quality clock sources whenever possible to decrease jitter and prevent bit errors. DCMs should never be used to drive reference clocks, because they introduce too much jitter.

For UltraScale™ architecture devices, the Xilinx implementation tools make necessary adjustments to the north-south routing and the pin swapping necessary to the GTH3 transceiver clock inputs to route clocks from one quad to another, when required.



**IMPORTANT:** *The following rules must be observed when sharing a reference clock to ensure that jitter margins for high-speed designs are met:*

1. In 7 series FPGAs, the total number of GTX or GTH transceiver quads sourced by an external clock pin pair must not exceed three quads (one quad above and one quad below), or 12

GTXE2\_CHANNEL/GTHE2\_CHANNEL transceivers. Designs in 7 series FPGAs with more than 12 transceivers or more than three quads should use multiple external clock pins.

See the 7 Series FPGAs GTX/GTH Transceivers User Guide (UG476) [Ref 7].

2. In UltraScale FPGAs, the total number of transceiver quads sourced by an external clock pin pair must not exceed five quads (two quads above and two quads below), or twenty

GTHE3/GTHE4\_CHANNEL transceivers. See the UltraScale FPGAs GTH Transceivers User Guide (UG576) [Ref 5]

3. For GTY core configuration and line rate > 16.375G, the Aurora 64b66b core will default to active transceiver Quads GTREFCLK. Each Quads GT Refclk should be individually fed. For more details, see UltraScale Architecture GTY Transceivers User Guide (UG578) [Ref 6]

*Manual editing of the transceiver attributes is not recommended but can be performed following the recommendations in the aforementioned GT user guides.*

4. Following are the clock relationship with the line rate in Aurora core.

$tx\_out\_clk = \text{Line rate} / (\text{internal data width})$ , internal data width is 32-bit for 7-series and UltraScale GTHE3/GTHE4 transceivers, 64-bit for GTYE3/GTYE4 transceivers

$txusr\_clk = rxusrclk2 = rxusrclk \text{ rate} = \text{Line rate} / (\text{internal data width})$

$txusr\_clk2 = user\_clk = \text{Line rate} / (\text{external data interface width})$ , where external data interface width is 64-bit for all transceivers

## Reset and Power Down

### Reset

The `reset_pb` signal is used to restore the Aurora 64B/66B core to a known starting state. Upon reset, the core stops the current operation and re-initializes the channel. It is expected that `user_clock` is stable when the `reset_pb` signal is applied. When the `reset_pb` signal to the Aurora 64B/66B channel partner1 is asserted, channel partner2 also loses lock. Channel partner2 regains lock when channel partner1 is out of reset and begins transmitting valid patterns. On full-duplex cores the `reset_pb` signal resets both the TX and RX sides of the channel. simplex Aurora 64B/66B cores have similar `reset_pb` ports for both partners and require a different reset sequence. Asserting `pma_init` resets the entire serial transceiver which eventually resets the Aurora 64B/66B core as well. Also, it is assumed `init_clk` is always stable and the `ref_clk` is stable at the time of deassertion of the `pma_init` signal.

## Reset Sequence

The following are recommended reset sequences for the Aurora 64B/66B core at the example design level for the available dataflow configurations.

**Note:** In the reset sequence diagrams the `init_clk` is added for illustration; both `reset_pb` and `pma_init` are asynchronous resets to the core.

### Aurora 64B/66B Duplex

During the board power-on sequence, both the `pma_init` and `reset_pb` signals are expected to be High. `INIT_CLK` and `GT_REFCLK` are expected to be stable during power-on for the proper functioning of the Aurora 64B/66B core. When both clocks are stable, `pma_init` is deasserted followed by the deassertion of `reset_pb`.

#### Aurora 64B/66B Duplex Power On Sequence

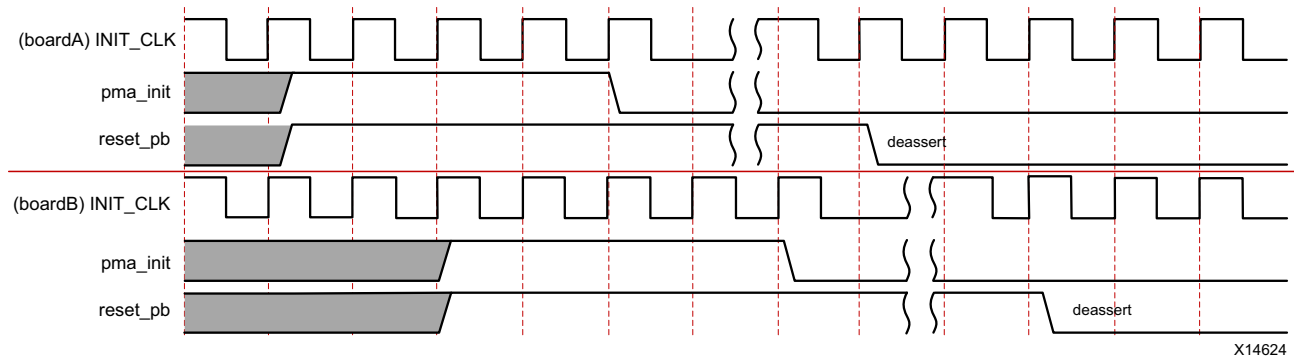

Figure 3-2: Aurora 64B/66B Duplex Power On Reset Sequence

#### Aurora 64B/66B Duplex Normal Operation Reset Sequence

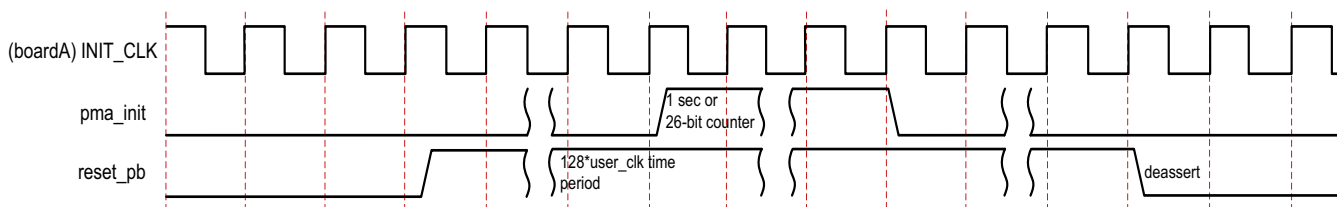

Figure 3-3: Aurora 64B/66B Duplex Normal Operation Reset Sequence

### Reset Sequencing

1. Assert reset. Wait for a minimum time equal to  $128 \times \text{user\_clk}$ 's time-period.
2. Assert `pma_init`. Keep `pma_init` and reset asserted for at least one second to prevent the transmission of CC characters and ensure that the remote agent detects a hot plug event.

3. Deassert `pma_init`.
4. Deassert `reset_pb`.

### Aurora 64B/66B Simplex

During power-on for both TX simplex and RX simplex cores, the `pma_init` and `reset_pb` signals are expected to be High. `INIT_CLK` and `GT_REFCLK` are expected to be stable during the power-on sequence. Due to the auto simplex recovery feature, both boards can be brought up independently. If the RX board is brought up first then when the TX board is brought up, data transmission can start immediately. However, if the TX board is brought up first then no data transmission should take place until the RX board comes up based on the periodic CB pattern sent by TX.

#### Aurora 64B/66B Simplex Power On Sequence

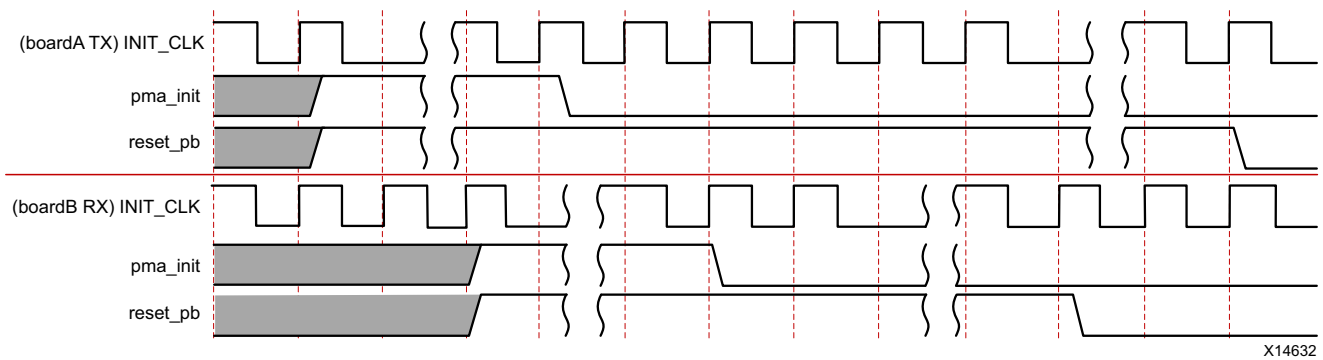

Figure 3-4: Aurora 64B/66B Simplex Power On Sequence

#### Aurora 64B/66B Simplex Normal Operation Reset Sequence

For simplex configurations, because the TX and RX can be powered on independently, data transmission must begin only after `rx_channel_up` is seen (that is, after a minimum of 45 ms of `tx_channel_up`), to avoid loss of data. Before asserting `pma_init`, the `reset_pb` must be asserted for a minimum time equal to  $128 * \text{user\_clk}$  time period to ensure that the portion of the core in programmable logic goes to a known reset state before the `user_clk` is held Low during `pma_init` assertion. The assertion time of `pma_init` must be a minimum of six `INIT_CLK` cycle time period to satisfy the requirements of the core de-bouncing circuit.

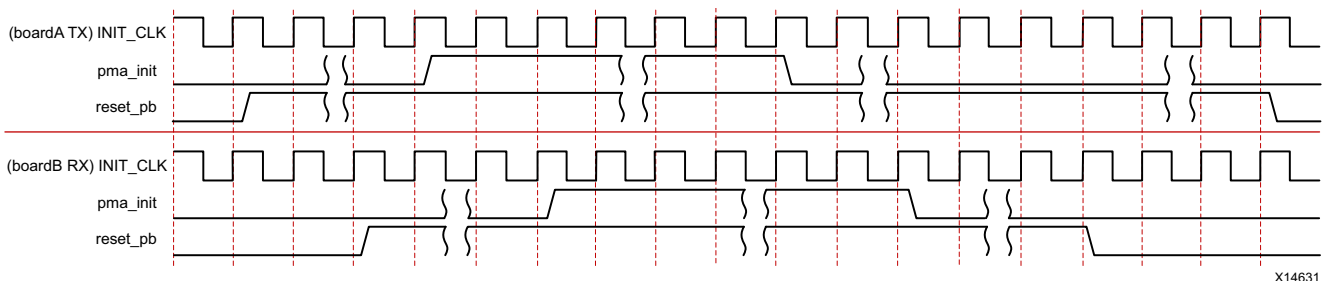

Figure 3-5: Aurora 64B/66B Simplex Normal Operation Reset Sequence

### Aurora 64B/66B Simplex TX and RX

After the `pma_init` signal is deasserted, both `tx_reset_pb` and `rx_reset_pb` can be deasserted at the same time. For proper functioning of the link, it is recommended that the data transmission must begin only after partner `rx_channel_up` is seen to avoid loss of data.

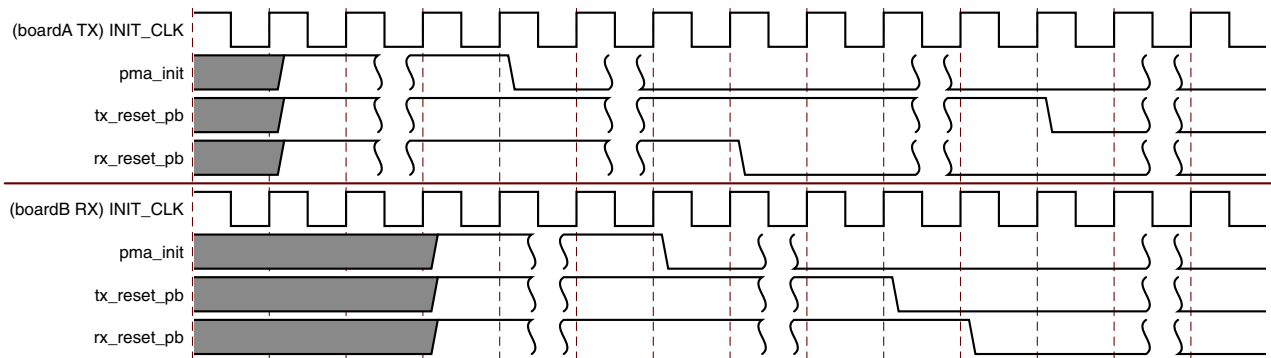

Figure 3-6: Aurora 64B/66B Simplex TX and RX Power On Sequence

For normal operation, follow the Aurora 64B/66B simplex normal operation reset sequence.

### pma\_init Staging in the Example Design

The top level `pma_init` input at the example design level is delayed for 128 `init_clk` cycles (`pma_init_stage`). This signal is pulse-stretched for the duration of a 24-bit counter (`pma_init_assertion`). An aggregate signal from the instantiating logic is provided to the core as the `pma_init` input. This ensures that the assertion of the `pma_init` signal to the core results in reset assertion to the entire core.

Inside the `<user_component_name>_support_reset_logic.v` source file, the debouncer logic (`reset_debounce_r`) remains in reset state until the `gt_reset_in` signal (`pma_init_assertion`) is High ensuring an internally generated reset whenever the top level `pma_init` is asserted. Figure 3-7 illustrates this behavior.

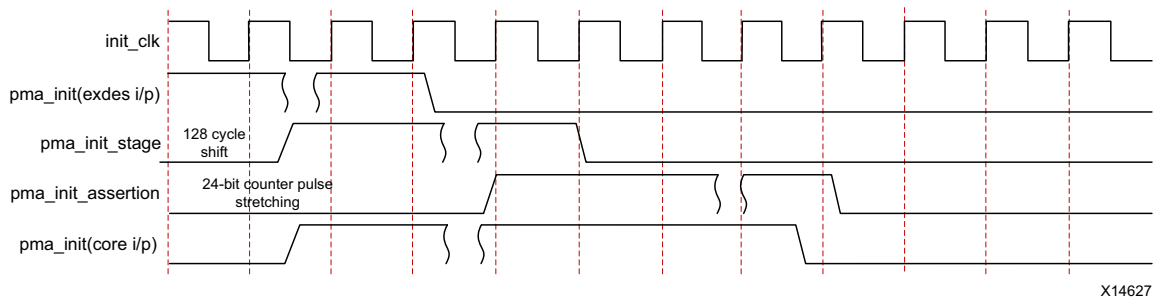

X14627

Figure 3-7: pma\_init Signal Staging

Assertion of the `pma_init` signal to the core results in hot-plug reset assertion in the channel partner core. The reset sequence after hot-plug reset assertion is shown in Figure 3-8.

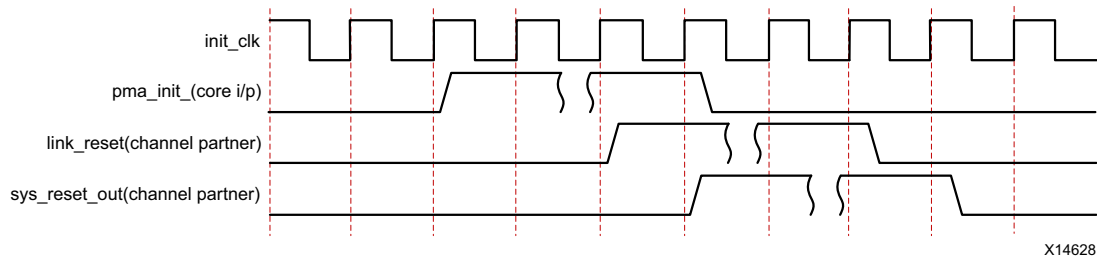

Figure 3-8: `pma_init` Signal Used to Reset Remote System

## Reset Flow

The top-level RESET input (example design level) is debounced and connected to the core (`reset_pb`). This signal is aggregated with the serial transceiver reset status and the hot-plug reset from within the core reset logic (`sys_reset_out`) to generate a reset to the core. This signal is expected to connect to the core reset input. Figure 3-9 illustrates this behavior.

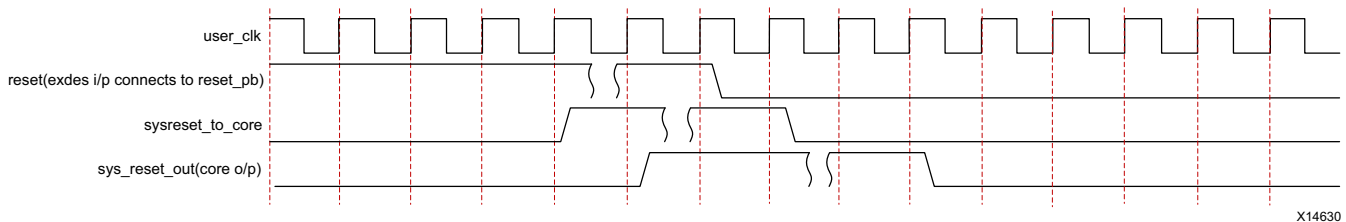

Figure 3-9: Reset Flow

## Single Reset Use Cases

### Use Case 1: `reset_pb` assertion in the duplex core

The reset assertion in the duplex core should be for a minimum time equal to  $128 * \text{user\_clk's time\_period}$ . As a result, `channel_up` is deasserted as shown in the Figure 3-10.

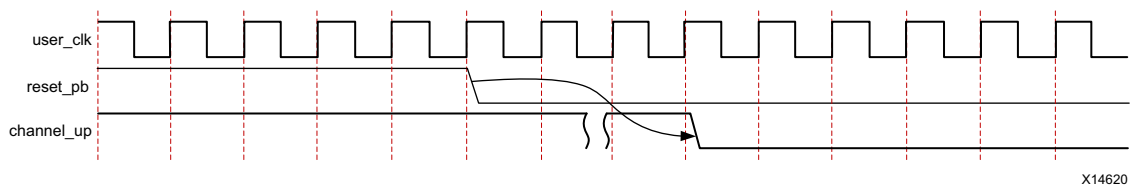

Figure 3-10: Assertion of reset in the Duplex Core

### Use Case 2: *pma\_init* Assertion in the Duplex Core

Figure 3-11 shows the `pma_init` assertion in the duplex core which should be a minimum of 128 `init_clk` cycles. As a result, `user_clk` is stopped after a few clock cycles because there is no `txoutclk` from the transceiver and `channel_up` is deasserted.

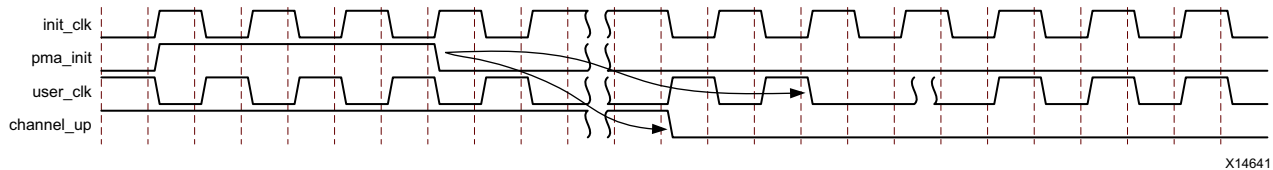

Figure 3-11: *pma\_init* Assertion in the Duplex Core

### Use Case 3: Assertion of *reset\_pb* in the Simplex Core

Figure 3-12 shows the simplex-TX core and simplex-RX core connected in a system. CONFIG1 and CONFIG2 can be in same or multiple device(s).

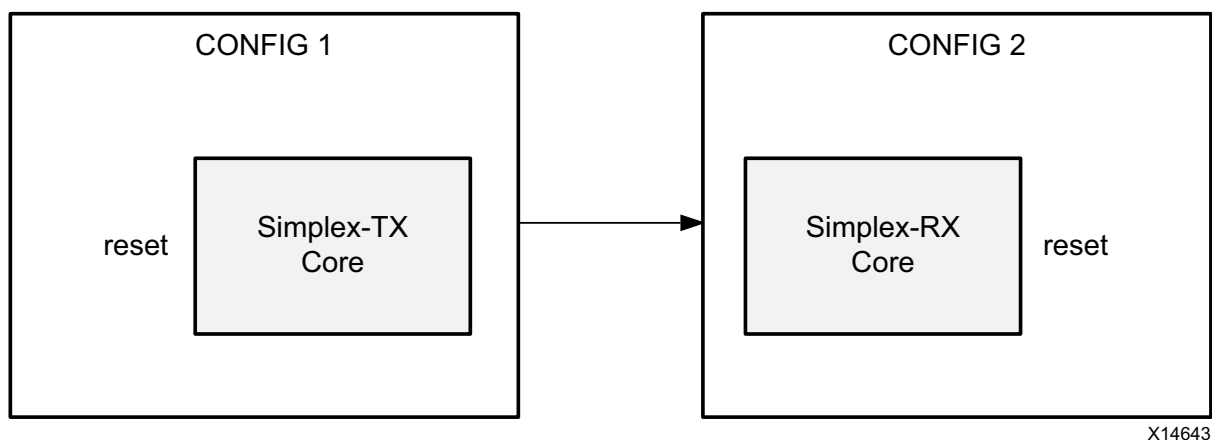
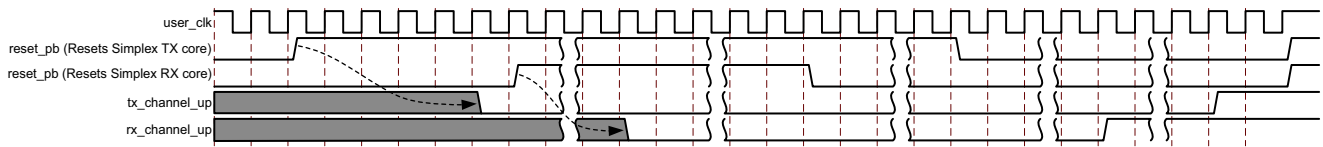

Figure 3-12: System with Simplex Cores

Following is the recommended procedure of TX cores reset and RX cores reset assertion in the simplex core (see Figure 3-13).

1. The TX cores `reset_pb` is asserted for a duration not less than  $128 * \text{user\_clk}$  time period followed by `reset_pb` on the RX simplex core asserted for a duration not less than  $128 * \text{user\_clk}$  time period.
2. `tx_channel_up` and `rx_channel_up` are deasserted after a minimum of five `user_clk` clock cycles.
3. The signal `reset_pb` in the RX simplex core is deasserted (or) released before `reset_pb` in the TX simplex core is deasserted. This sequence occurs because, while the auto simplex recovery feature allows both boards to be brought up independently, this ensures that TX transmits the Aurora 64B/66B initialization sequence when the simplex-RX core is ready.

4. `rx_channel_up` is asserted before `tx_channel_up` assertion. This condition must be satisfied by the simplex-RX core and the simplex timer parameters (`SIMPLEX_TIMER_VALUE`) in the simplex-TX core need to be adjusted to meet this criteria. The `SIMPLEX_TIMER_VALUE` parameter can be updated in `<user_component_name>_core.v`.
5. `tx_channel_up` is asserted after the simplex-TX core completes the Aurora 64B/66B protocol channel initialization sequence transmission for the configured time. Asserting `tx_channel_up` last ensures that the simplex-TX core transmits an Aurora 64B/66B initialization sequence when the simplex-RX core is ready.



X14633

Figure 3-13: Reset Assertion in Simplex Cores

6. For TX/RX simplex cores, the reset sequence in duplex cores for `reset_pb` and `pma_init` assertions can be followed. However, the `SIMPLEX_TIMER_VALUE` needs to be tuned based on the use model of the core.

## Power Down

When `power_down` is asserted, only the Aurora 64B/66B core logic is reset. This does not turn off the GTX, GTH or GTY transceivers used in the design.



**CAUTION!** Be careful when asserting this signal on cores that use `tx_out_clk` (see [Reference Clocks for FPGA Designs](#)). `tx_out_clk` stops when the GTX, GTH and GTY transceivers are powered down. See the [7 Series FPGAs GTX/GTH Transceivers User Guide \(UG476\) \[Ref 7\]](#), the [UltraScale Architecture GTH Transceivers User Guide \(UG576\) \[Ref 5\]](#) and the [UltraScale Architecture GTY Transceivers User Guide \(UG578\) \[Ref 6\]](#) for details.



## Timing

Figure 3-14 shows the timing for the reset signal. In a quiet environment,  $t_{CU}$  is generally less than 500 clock cycles. In a noisy environment,  $t_{CU}$  can be much longer.

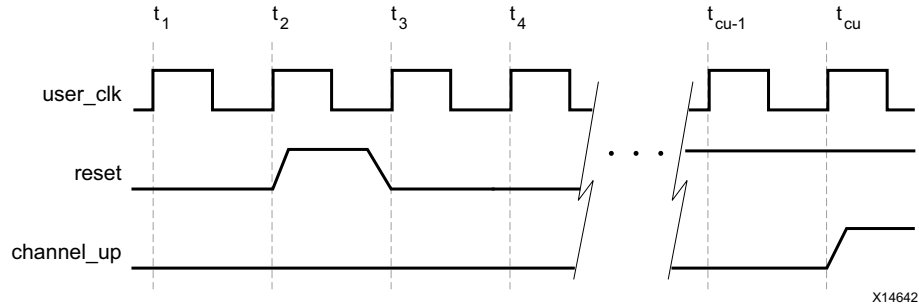

Figure 3-14: Reset and Power Down Timing

## Shared Logic

The **Include Shared Logic in core** option on the Vivado® Integrated Design Environment (IDE) Shared Logic page can be used to configure the core to include shareable resources such as the transceiver quad PLL (QPLL), the transceiver differential `refclk` buffer (IBUFDS\_GTE2), and including clocking and reset logic either in the core or in the example design. When the **Include Shared Logic in core** option is selected, all shareable resources are available to multiple instances of the core which might not include them. This minimizes the amount of HDL modifications required while retaining core flexibility.

**Note:** The **Single Ended** option when share logic is in the core will exclude respective differential clock buffers from the core.

The shared logic hierarchy is called `<user_component_name>_support`. Figure 3-15 and Figure 3-16 show two hierarchies where the shared logic block is contained either in the core or in the example design. In these figures, `<user_component_name>` is the name of the generated core. The difference between the two hierarchies is the boundary of the core. The hierarchy is controlled using the Shared Logic options in the Vivado IDE. (The `xci` top is highlighted in gray.)

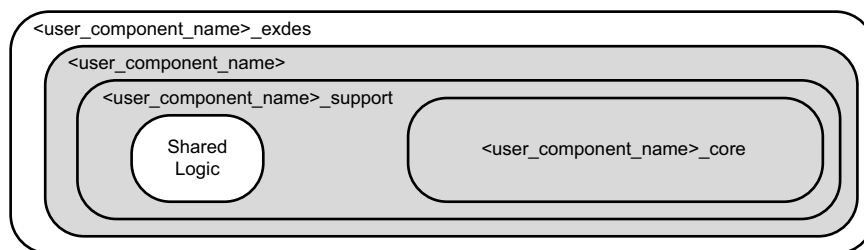

Figure 3-15: Shared Logic Included in Core

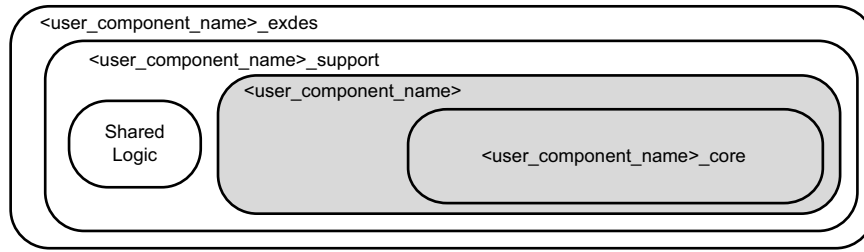

Figure 3-16: Shared Logic Included in Example Design

The contents of the shared logic depend upon the physical interface and the target device. Shared logic contains one or more instances of the transceiver differential buffer, support reset logic and instantiations of `<user_component_name>_clock_module`. Shared logic also contains either the `GTXE2_COMMON` or the `GTHE2_COMMON` block which is instantiated based on the selected transceiver type (GTX or GTH). Support reset logic contains the de-bouncer logic for the reset and `gt_reset` ports.

In the Vivado IP integrator, the connections between the two modes are shown for channel phase-locked loop (CPLL) based designs. As can be seen in Figure 3-17, the master `gt_reset` signal affects slave operation. For QPLL-based designs, `gt_qpllrefclklost` and `gt_qplllock` need to be connected. In Figure 3-17, the master core includes shared logic in the core and the slave core includes shared logic in the example design. If `dataflow_config` selected is TX/RX\_Simplex, then the master `tx_sys_reset_out`, `rx_sys_rest_out` should be connected to the slave `tx_reset_pb`, `rx_reset_pb` respectively.

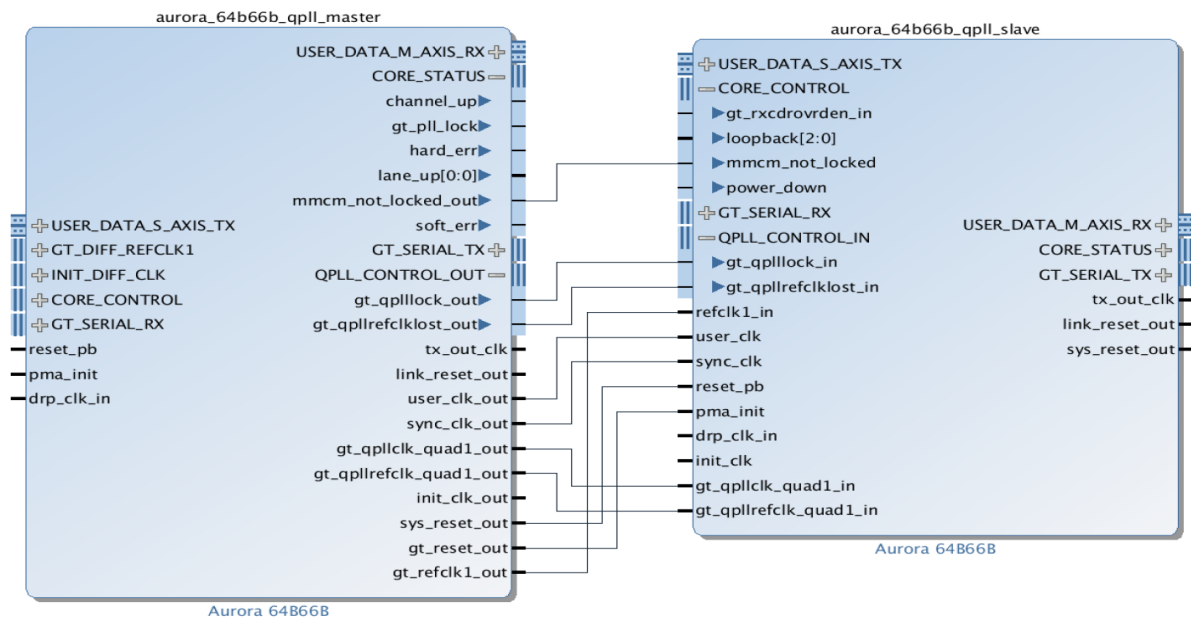

Figure 3-17: Shareable Resource Connection Example Using IP Integrator

See [Table 2-6, page 22](#) and [Table 2-11](#) for details about the port changes resulting from the setting of the shared logic option.

[Table 3-1](#) shows the available shared resources based on the transceiver type.

**Table 3-1: Aurora 64B/66B Core Available Shared Resources by Transceiver Type**

Transceiver Type	Available Shared Resources
Zynq-7000 and 7 series devices GTX/GTH transceivers	IBUFDS_GTE2: transceiver reference clock GTXE2_COMMON: GTX transceiver clocking GTHE2_COMMON: GTH transceiver clocking BUFG/MMCM: clocking IBUFDS: init_clk
UltraScale/UltraScale+ GTH/GTY Transceivers	IBUFDS_GTE3: transceiver reference clock IBUFDS_GTE4: transceiver reference clock GTHE3_COMMON: GTH transceiver clocking GTHE4_COMMON: GTH transceiver clocking GTYE3_COMMON: GTY transceiver clocking GTYE4_COMMON: GTY transceiver clocking BUFG_GT: clocking

## Using CRC

CRC is included in the core if the CRC mode option is selected. A framing user data interface with 32-bit CRC is available in the `<user_component_name>_crc_top.v` file. The `crc_valid` and `crc_pass_fail_n` signals (see [Table 2-13, page 53](#)) indicate the result of a received frame transmitted with [CRC Interface](#).

## Hot Plug Logic

Hot-plug logic in Aurora 64B/66B designs is based on the received clock compensation characters. Reception of clock compensation characters at the RX interface of Aurora 64B/66B infers that the communication channel is active and not broken. If clock compensation characters are not received in a predetermined time, the hot-plug logic resets the core and the transceiver. The clock compensation module must be used for Aurora 64B/66B designs.



**IMPORTANT:** *It is highly recommended to keep hot plug logic enabled for predictable operation of the link.*

The description of the hot-plug sequence follows.

1. Requirements: Before replacing the card, powering down a specific system, or reprogramming the bit file, it is required to assert `reset` before performing a hot plug sequence so that the remote agent channel goes down gracefully and gets ready when the link is removed and reconnected.
2. How it works: When `reset` is asserted for a time equal to  $128 * \text{user\_clk\_time\_period}$  before performing a hot plug sequence, enough `NA_IDLE`s are generated for the remote link to deassert Channel Up without errors.
3. Limitations: If the preceding sequence is not followed, `SOFT/DATA` errors are possible so that the link does not have a graceful shutdown.

## Clock Compensation Logic

The Aurora 64B/66B core includes a clock compensation module that is used to generate periodic clock compensation sequences in accordance with the *Aurora 64B/66B Protocol Specification* (SP011) [Ref 9].

The clock compensation feature allows up to  $\pm 100$  ppm difference in the reference clock frequencies used on each side of an Aurora 64B/66B channel.

To perform Aurora 64B/66B-compliant clock compensation, the clock compensation sequence is sent every 4,992 `user_clk` cycles. The CC sequence consists of a maximum of 8 CC characters. The signal `s_axi_tx_tready` is deasserted on the TX user interface while the channel is being used to transmit clock compensation sequences.

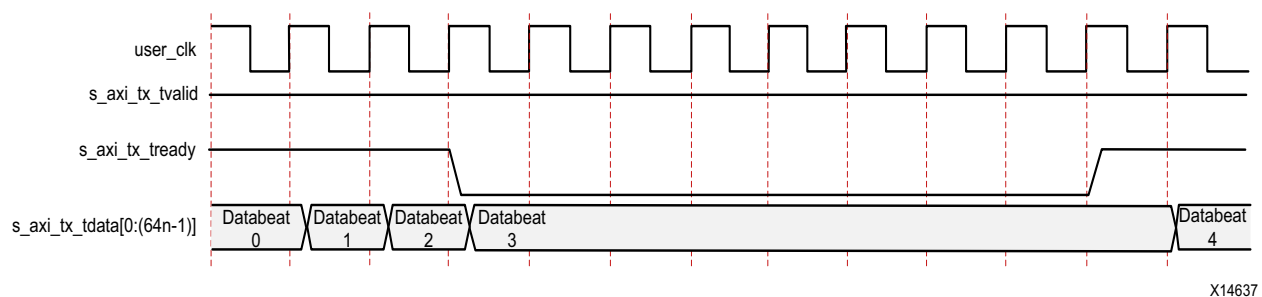

Figure 3-18: Streaming Data with Clock Compensation Inserted

X14637

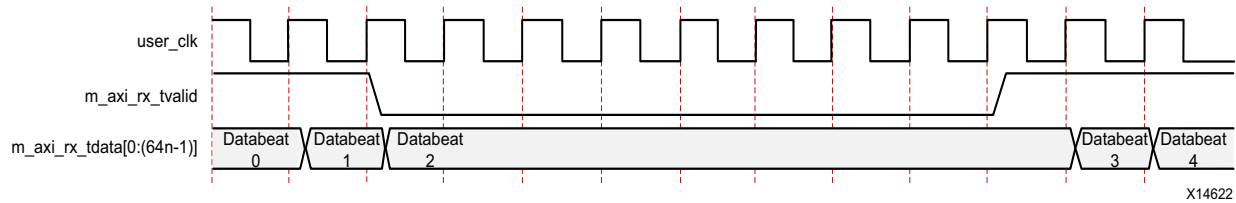

Figure 3-19: Data Reception Interrupted by Clock Compensation

The most common use of this feature is scheduling clock compensation events to occur outside of frames, or at specific times during a stream to avoid interrupting data flow.



**IMPORTANT:** The parameter *CC\_FREQ\_FACTOR* determines the frequency of the CC sequence. It is fixed at 24. Any attempt to increase or decrease this parameter should be done with careful analysis and testing.

Following are the clock compensation logic customizing guidelines:

- Ensure that the duration and period selected are sufficient to correct for the maximum difference between the frequencies of the clocks used.
- Do not perform multiple clock compensation sequences within eight cycles of one another.

## Using Little Endian Support

The Aurora 64B/66B core supports the user interfaces in big endian format by default. The core also supports little endian format allowing easy connection to AXI4-Stream compliant IP designs.

**Note:**

1.  $[n:0]$  bus format is used when the little endian support option is selected.  $[0:n]$  bus format is used when the big endian support option is selected. The core has an option to configure the AXI4-Stream User I/O as little endian from the Vivado IDE. The default is big endian.
2. Ports are active-High unless specified otherwise.

# Design Flow Steps

This chapter describes customizing and generating the core, constraining the core, and the simulation, synthesis and implementation steps that are specific to this IP core. More detailed information about the standard Vivado® design flows and the IP integrator can be found in the following Vivado Design Suite user guides:

- *Vivado Design Suite User Guide: Designing IP Subsystems using IP Integrator* (UG994) [Ref 11]
- *Vivado Design Suite User Guide: Designing with IP* (UG896) [Ref 12]
- *Vivado Design Suite User Guide: Getting Started* (UG910) [Ref 13]
- *Vivado Design Suite User Guide: Logic Simulation* (UG900) [Ref 14]

---

## Customizing and Generating the Core

This section includes information about using Xilinx tools to customize and generate the core in the Vivado Design Suite.

When customizing and generating the core in the Vivado IP integrator, see the *Vivado Design Suite User Guide: Designing IP Subsystems using IP Integrator* (UG994) [Ref 11] for detailed information. The IP integrator might auto-compute certain configuration values when validating or generating the design. To check whether the values change, see the description of the parameter in this chapter. To view the parameter value, run the `validate_bd_design` command in the Tcl Console.

Use the following steps to customize the IP for use in your design by specifying values for the various parameters associated with the IP core:

1. Select the IP from the Vivado IP catalog (**IP Catalog** -> **Aurora 64B66B**).
2. Double-click the selected IP or select **Customize IP** from the toolbar or right-click menu.

For details, see the *Vivado Design Suite User Guide: Designing with IP* (UG896) [Ref 12] and the *Vivado Design Suite User Guide: Getting Started* (UG910) [Ref 13].

The Aurora 64B/66B core can be customized to suit a wide variety of requirements using the IP catalog. This chapter details the customization parameters and how these parameters are specified within the Vivado Integrated Design Environment (IDE).

[Figure 4-1](#) through [Figure 4-5](#) show the features described in the corresponding sections. The left side displays a representative block diagram of the Aurora 64B/66B core as currently configured. The right side consists of user-configurable parameters.

[Figure 4-1](#) shows the Core Options tab of the Customize IP interface with the default options for Zynq®-7000 and 7 series devices.

[Figure 4-2](#) shows the Core Options tab for UltraScale™ devices. Details on the customizing options are provided in the following subsections, starting with [Component Name](#).

**Note:** Figures in this chapter are illustrations of the Vivado IDE. This layout depicted here might vary from the current version.

## Core Options Tab for 7 Series FPGAs

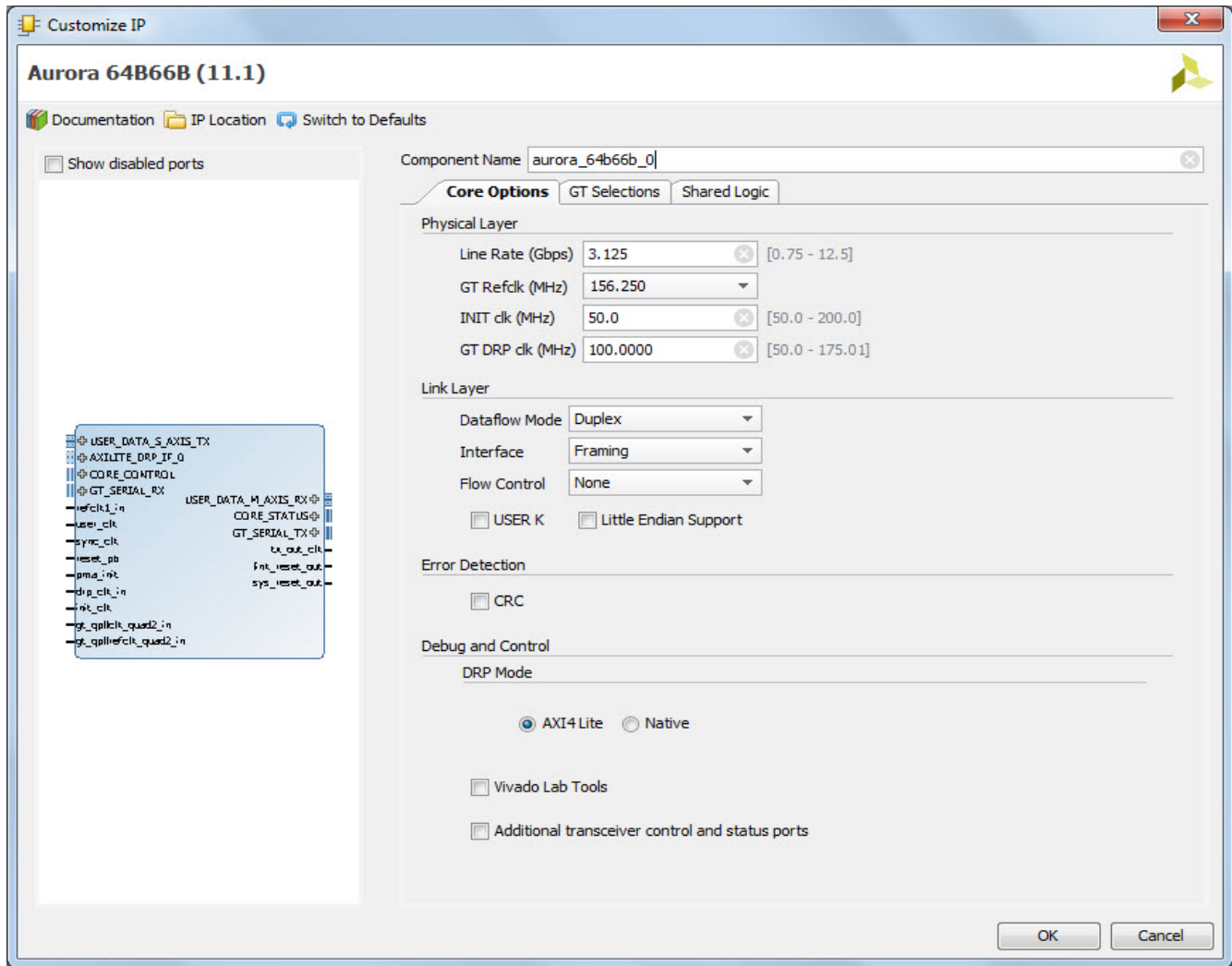

Figure 4-1: Aurora 64B/66B IP Catalog Core Options Tab for 7 Series FPGAs

### Component Name

Enter the top-level name for the core in this text box. Illegal names are highlighted in red until they are corrected. All files for the generated core are placed in a subdirectory using this name. The top-level module for the core also use this name.

Default: aurora\_64b66b\_0

### Line Rate

Enter the line rate value in gigabits per second. The value entered must be within the valid range shown. This value determines the unencoded bit rate at which data is transferred over the serial link. Calculations based on line rate use enhanced precision. Line rate value is



restricted to four decimal digits for UltraScale with the exception of 25.78125 Gb/s for GTY devices.

Default: 3.125 Gb/s for 7 series FPGA transceivers, 10.3125 Gb/s for UltraScale™ FPGA GTH and GTY transceivers and 25.78125 Gb/s for GTHE4/GTYE4 transceivers.

### ***GT Reference Clock Frequency***

Select a reference clock frequency in MHz from the list box which provides options based on the selected line rate. For best results, select the highest rate that can be practically applied to the reference clock input of the target device.

Default: 156.25 MHz

### ***INIT clk (MHz)***

Enter a valid INIT clock frequency in the text box.

Default: 50 MHz for 7 series FPGAs and Zynq® AP SoCs, line\_rate/datapath\_width for UltraScale™ devices.

### ***GT DRP clk (MHz)***

Enter a valid DRP clock frequency in the text box. Available only with 7 series FPGA transceivers.

Default: 100 MHz

### ***Dataflow Mode***

Select the options for the direction of the channel that the Aurora 64B/66B core supports. Simplex cores have a single, unidirectional serial port that connects to a complementary simplex core. Three simplex options are provided to select the channel direction supported by the core: **RX-only\_simplex**, **TX-only\_simplex** or **TX/RX\_simplex**.

**Duplex** or **TX/RX\_simplex** specify that the core has both TX and the corresponding RX communication channels.

Default: Duplex

### ***Interface***

Select the type of datapath interface used for the core. Select **Framing** to use a complete AXI4-Stream interface that allows encapsulation of data frames of any length. Select **Streaming** to use a simple AXI4-Stream interface to stream data through the Aurora 64B/66B channel.

Default: Framing

## ***Flow Control***

Select the required option to add flow control to the core. *User* flow control (UFC) allows applications to send each other brief, high-priority messages through the Aurora 64B/66B channel. *Native* flow control (NFC) allows full-duplex receivers to regulate the rate of the data sent to them. Immediate mode allows idle codes to be inserted within data frames while completion mode only inserts idle codes between complete data frames.

Available options are:

- None
- UFC only
- Immediate NFC
- Completion NFC
- UFC + Immediate NFC
- UFC + Completion NFC

For the streaming interface, only immediate mode is available. For the framing interface, both immediate and completion modes are available.

Default: None

## ***USER K***

Select to add a USER K interface to the core. USER-K blocks are special single-block codes passed directly to the user application. These blocks are used to implement application-specific control functions.

Default: Unchecked

## ***Little Endian Support***

Select to change all of the interface(s) to little endian format. See [Using Little Endian Support in Chapter 3](#) for more information, By default the core uses big endian format.

Default: Unchecked

## ***CRC***

Select the option to insert CRC32 in the data stream.

Default: Unchecked

### ***DRP Mode***

Select the required interface to control or monitor the transceiver interface using the DRP.

Available options are:

- Native
- AXI4\_Lite

Default: AXI4\_Lite

### ***Vivado Lab Tools***

Select to add Vivado lab tools to the Aurora 64B/66B core. (See [Using Vivado Lab Tools, page 97.](#)) This option provides a debugging interface that shows the core status signals.

Default: Unchecked

### ***Additional Transceiver Control and Status Ports***

Select to include transceiver control and status ports in core top level.

Default: Unchecked

## Core Options Tab for UltraScale Devices

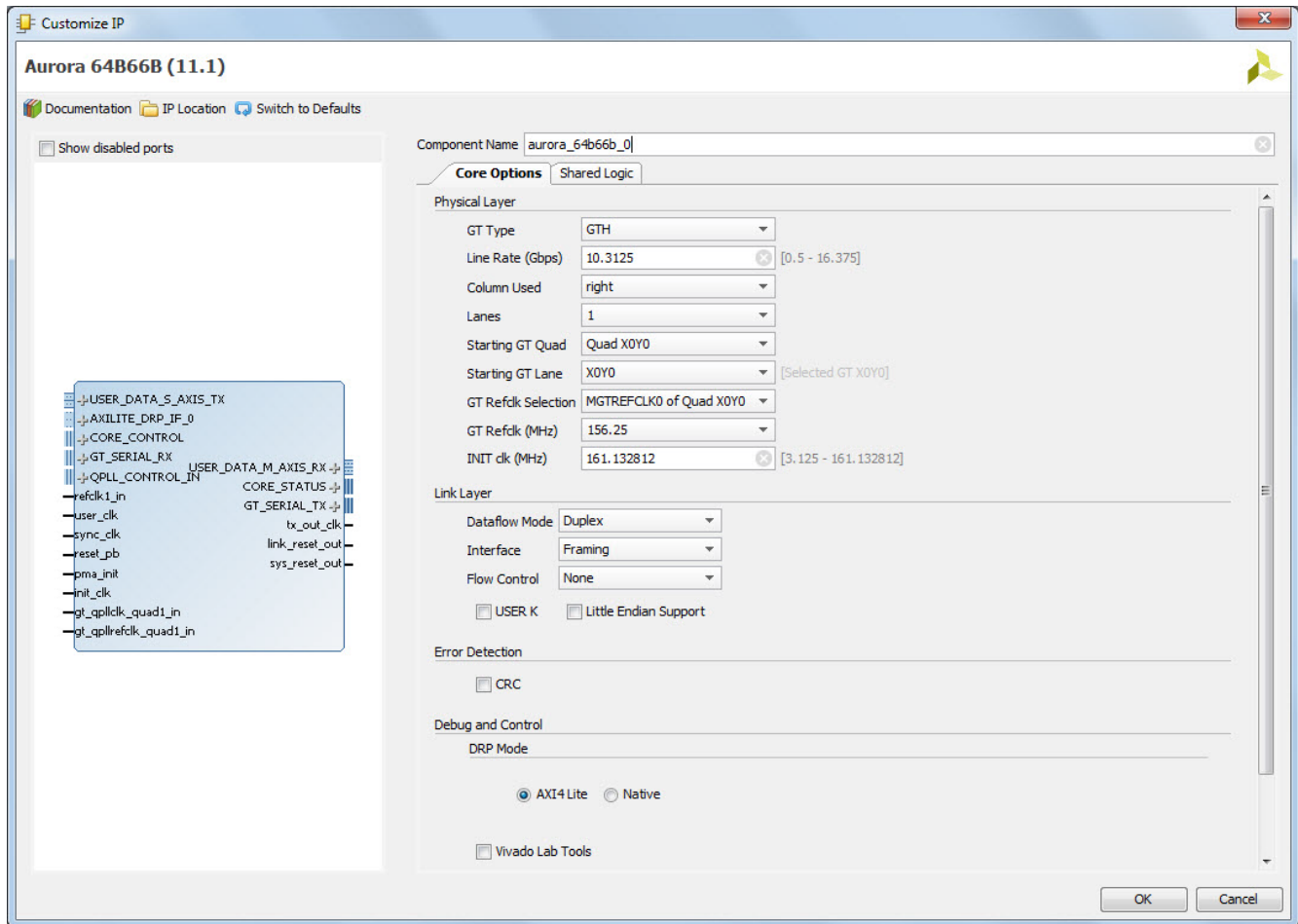

Figure 4-2: Aurora 64B/66B IP Catalog UltraScale Core Options Tab

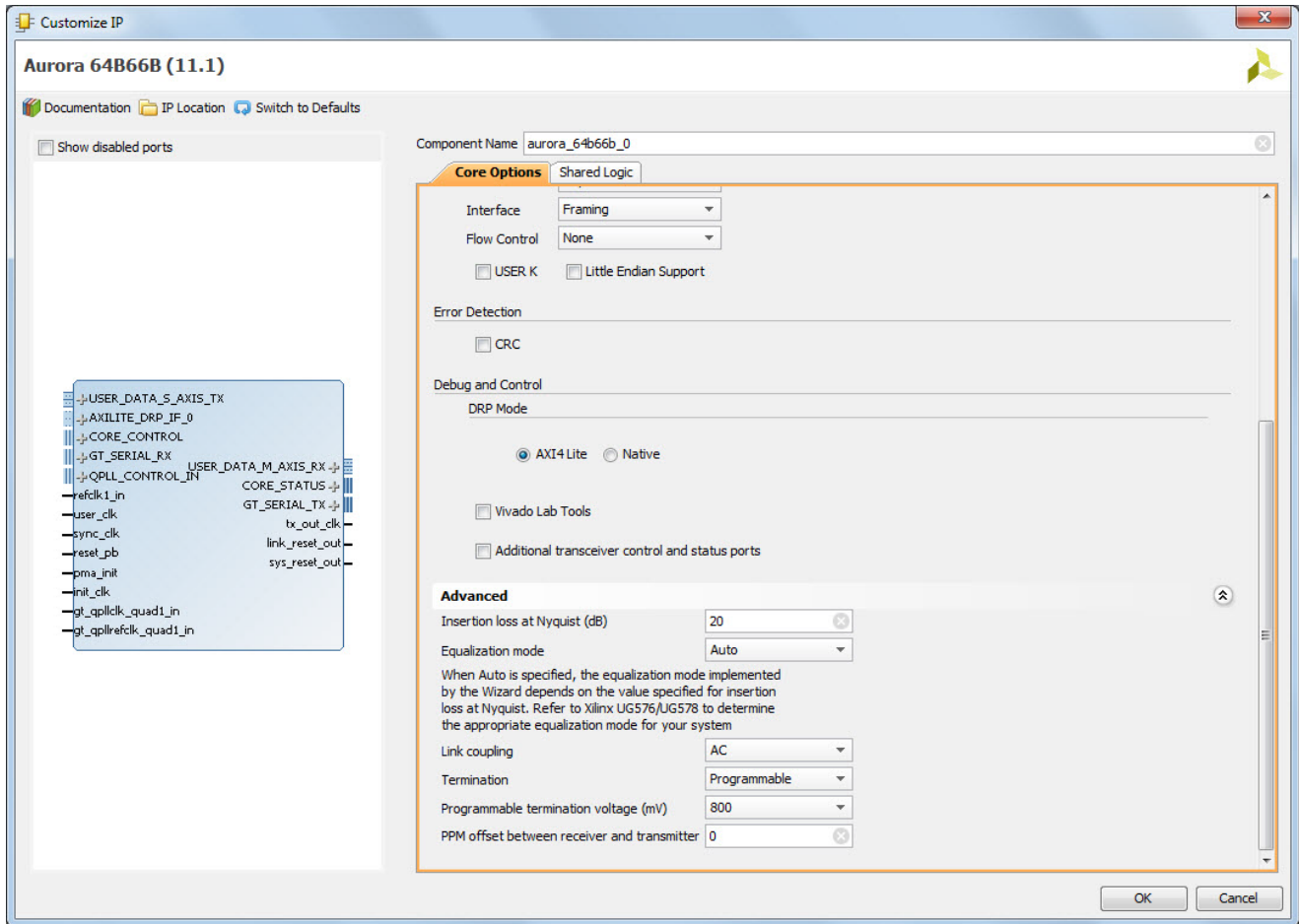

Figure 4-3: Aurora 64B/66B IP Catalog UltraScale Core Options Tab showing Advanced GT selection

The following four customization options are shown only in the Core Options tab for UltraScale devices. See *UltraScale FPGAs Transceivers Wizard* (PG182)[Ref 28] for additional details on the Advanced GT options selection. Figure 4-2 and Figure 4-3 shows the Core Options tab for UltraScale™ device.

### Lanes

Select the number of lanes (UltraScale device GTH transceivers) to be used in the core. The valid range depends on the target device selected.

Default: 1

### Starting GT Quad

Select the GT (also known as serial transceiver) Quad from the drop down list. The selected GT Quad has the starting lane from which the lane assignment begins.

Default: Quad X0Y0

### **GT Type**

Select the GT transceiver type from the drop-down menu. The options provided are GTH and GTY.

Default: GTH

### **Starting GT Lane**

Select the starting lane of the core from the drop-down list that is generated based on the selected GT Quad. With Lanes, Starting GT Quad and Starting GT lane, the core gets generated with a consecutive number of lanes.

Default: X0Y0

**Note:** Channel bonding across SLR boundaries is not supported by the core and restricted from the Vivado IDE.

### **GT Refclk Selection**

Select reference clock sources for the UltraScale transceivers from the drop-down list.

Default: MGTREFCLK0 of Quad X0Y0



---

**CAUTION!** For GTY core configuration and line rate > 16.375G, the GT Refclk selection option will not be available. The Aurora 64b66b core will default to active transceiver Quads GTREFCLK. Each Quads GT Refclk should be individually fed. For more details, see the UltraScale Architecture GTY Transceivers User Guide (UG578) [\[Ref 6\]](#)

---

## GT Selections Tab for 7 Series FPGA

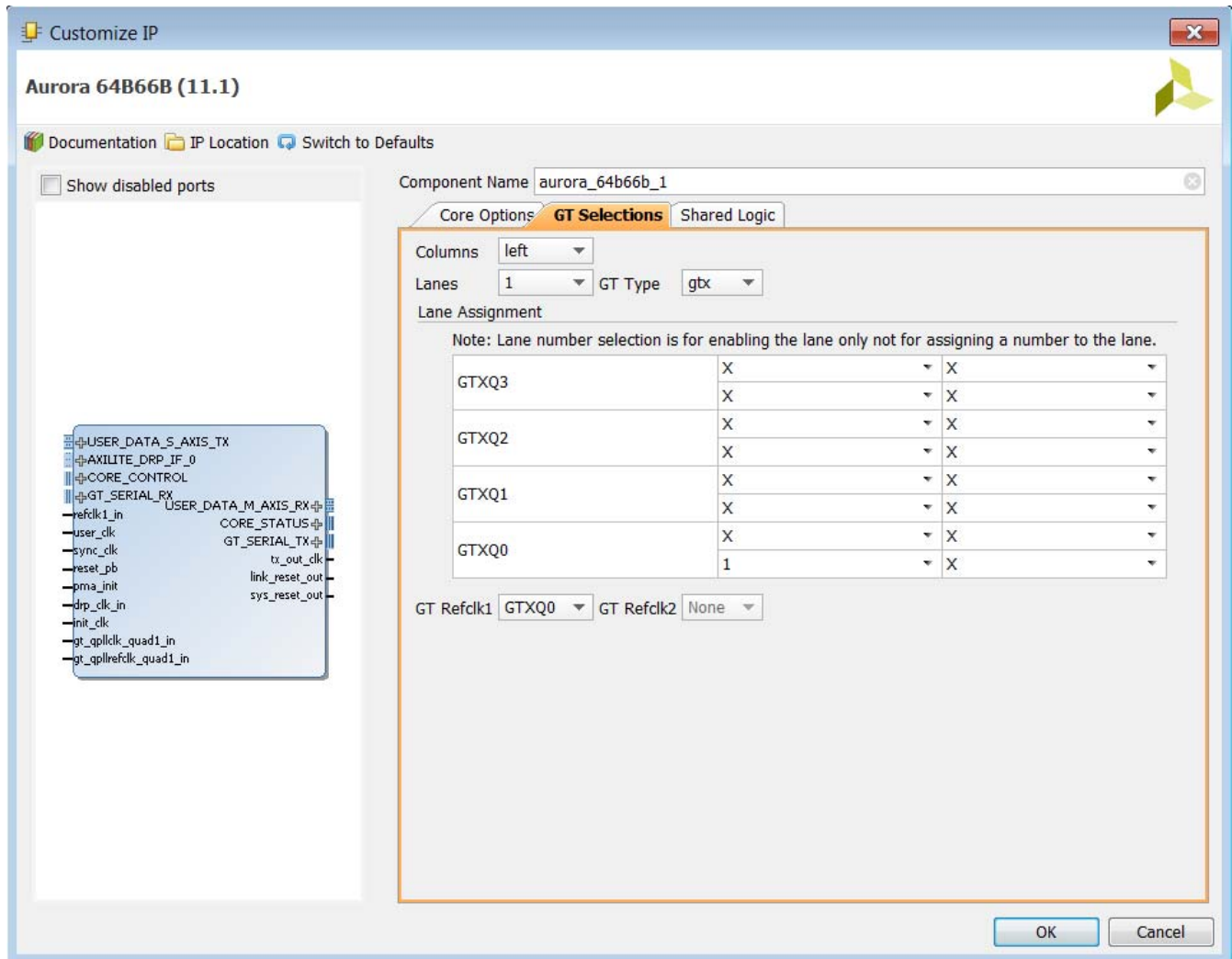

Figure 4-4: Aurora 64B/66B IP Catalog GT Selections Tab for 7 Series FPGAs

### Columns

Select appropriate GT column from the drop-down list.

Default: left

### Lanes

Select the number of lanes (GTX or GTH transceivers) to be used in the core. The valid range depends on the target device selected.

Default: 1

## GT\_TYPE

Select the type of serial transceiver from the drop-down list. This option is applicable only for Virtex®-7 XT devices. For other devices, the drop-down box is not visible.

Available options are:

- gtx
- v7gth

Default: gtx

## Lane Assignment

See the diagram in the information area in [Figure 4-4](#). Each numbered row represents a serial transceiver tile and each active box represents an available GTX or GTH transceiver. For each Aurora 64B/66B lane in the core, starting with Lane 1, select a GTX or GTH transceiver and place the lane by selecting its number in the GTX or GTH transceiver placement box.

- X in the drop-down menu means that lane is not selected.
- <1—16> selected from the drop-down menu means that particular lane is selected. It does not assign that number to the physical lane.



---

**RECOMMENDED:** *Always select consecutive/physically adjacent lanes for a multi-GT design.*

---

**Note:** The core generates transceiver placement (LOC) constraints in ascending fashion. Move the cursor in the Vivado IDE to see the transceiver being selected in the 7 series and Zynq®-7000 family-based design. Lane numbering serves only to enable the lanes and not to assign numbers to the lanes. The Lane Assignment is not available for UltraScale architecture-based designs. It is strongly recommended that lane selection should be continuous for timing closure.

## GT REFCLK1 and GT REFCLK2

Select reference clock sources for the GTX and GTH transceiver tiles from the drop-down list in this section.

Default: GT REFCLK Source 1: GTXQn/ GTHQn; GT REFCLK Source 2: None;

**Note:** *n* depends on the serial transceiver (GTX or GTH) position.



## Shared Logic

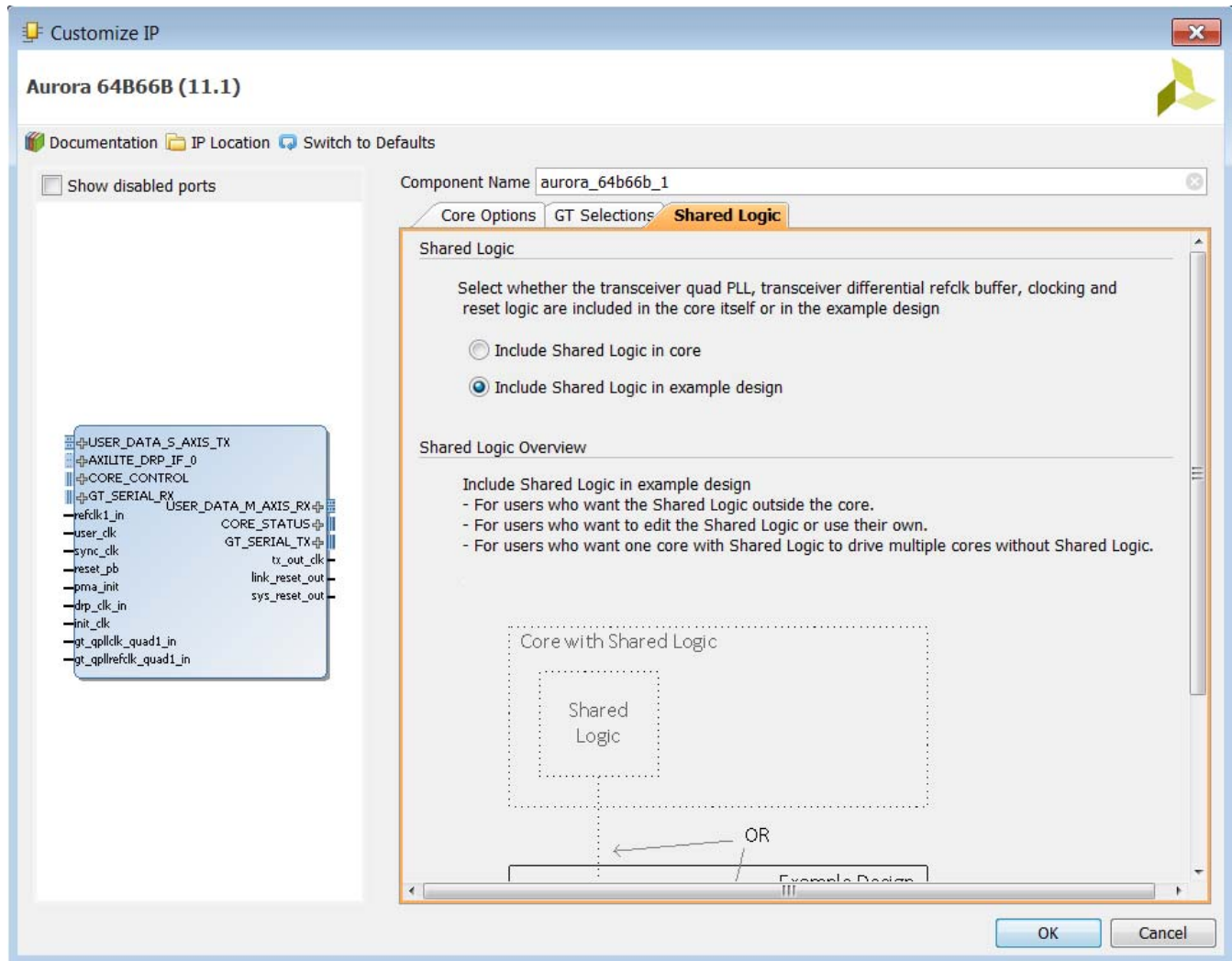

Figure 4-5: Aurora 64B/66B IP Catalog Shared Logic Tab for 7 Series FPGAs

Select to include transceiver common PLL and its logic in the IP core or in the example design.

Available options:

- Include Shared Logic in core
- Include Shared Logic in example design

Default: Include Shared Logic in example design

If the **Include Shared Logic in core** option is selected, two additional options are available:

- Single Ended INIT CLK - If selected, `init_clk` becomes a single-ended clock input. Available only in 7 series devices.

- Single Ended GTREF CLK - If selected, the GT reference clock becomes a single-ended clock input.

Click **OK** to generate the core. (See [Generating the Core with Quick Start, page 93.](#)) The modules for the Aurora 64B/66B core are written to the IP catalog tool project directory using the same name as the top level of the core.

**Notes:**

1. In the IP integrator the core gives the expected frequency values in long format as per the IP integrator guidelines; however, internally the precision is the same as shown in Vivado IDE.
2. In the IP integrator the clock and reset ports are grouped into the single-clock port and single-reset port interfaces respectively. Data and AXI4-Stream flow control ports are grouped into AXI4-Stream interfaces. The other input and output ports are grouped into display interfaces.
3. For the ports grouped in display interfaces the connections need to be made port-to-port.
4. The non-AXI UFC ports are listed below the UFC interfaces.
5. Based on the configuration chosen, the expected frequency values are shown for the clock inputs to the core.

## User Parameters

Table 4-1 shows the relationship between the fields in the Vivado IDE and the User Parameters in the XCI files (which can be viewed in the Tcl Console). Use the information in the tables for batch-driven Tcl flows to set Vivado IDE parameters and generate the Aurora 64B/66B core.

Table 4-1: Vivado IDE Parameter to User Parameter Mapping<sup>(1)</sup>

Vivado IDE Parameter/Value	User Parameter/Value	Default Value <sup>(1)</sup>
<b>Core Options</b>		
<b>Physical Layer</b>		
Line Rate (Gb/s)	C_LINE_RATE	3.125/ 10.3125
GT Type <sup>(11)</sup>	C_GT_TYPE	GTH/GTY
Column Used <sup>(11)</sup>	C_UCOLUMN_USED	right
Starting GT Quad <sup>(11)</sup>	C_START_QUAD	Quad X0Y0
Starting GT Lane <sup>(11)</sup>	C_START_Lane	X0Y0
GT Refclk Selection <sup>(11)</sup>	C_REFCLK_SOURCE	MGTREFCLK0 of Quad X0Y0
GT Refclk (MHz) <sup>(13)</sup>	C_REFCLK_FREQUENCY	156.250
INIT clk (MHz)	C_INIT_CLK	50.0/ 161.1328125
GT DRP clk (MHz) <sup>(9)</sup>	DRP_FREQ	100.0000
<b>Link Layer</b>		
Dataflow Mode	Dataflow_Config	Duplex
Interface	Interface_Mode	Framing

Table 4-1: Vivado IDE Parameter to User Parameter Mapping<sup>(1)</sup> (Cont'd)

Vivado IDE Parameter/Value	User Parameter/Value	Default Value <sup>(1)</sup>
Flow Control	Flow_Mode	None
USER-K	C_USER_K	false
Little Endian Support	C_USE_BYTESWAP	false
<b>Error Reduction</b>		
CRC	CRC_MODE	NONE
<b>DRP Mode</b>		
AXI4-Lite (default mode)	drp_mode	AXI4_LITE
Native		
Vivado lab tools	C_USE_CHIPSCOPE	false
Additional transceiver control and status ports	TransceiverControl	false
<b>GT Selections<sup>(9)</sup></b>		
Columns	C_COLUMN_USED	right <sup>(3)</sup>
Lanes <sup>(10)</sup>	C_AURORA_LANES	1
GT Type <sup>(10)</sup>	C_GT_TYPE	gtx <sup>(4)</sup>
<b>Lane Assignment</b>		
Select transceiver to include GTXE2_CHANNEL_X1Y4 in your design <sup>(5)</sup>	C_GT_LOC_5 <sup>(6)</sup>	1
Select transceiver to include GTXE2_CHANNEL_X1Y5 in your design	C_GT_LOC_6	X
Select transceiver to include GTXE2_CHANNEL_X1Y5 in your design	C_GT_LOC_7	X
Select transceiver to include GTXE2_CHANNEL_X1Y7 in your design	C_GT_LOC_8	X
Select transceiver to include GTXE2_CHANNEL_X1Y8 in your design	C_GT_LOC_9	X
Select transceiver to include GTXE2_CHANNEL_X1Y9 in your design	C_GT_LOC_10	X
Select transceiver to include GTXE2_CHANNEL_X1Y10 in your design	C_GT_LOC_11	X
Select transceiver to include GTXE2_CHANNEL_X1Y11 in your design	C_GT_LOC_12	X
Select transceiver to include GTXE2_CHANNEL_X1Y12 in your design	C_GT_LOC_13	X
Select transceiver to include GTXE2_CHANNEL_X1Y13 in your design	C_GT_LOC_14	X
Select transceiver to include GTXE2_CHANNEL_X1Y14 in your design	C_GT_LOC_15	X
Select transceiver to include GTXE2_CHANNEL_X1Y15 in your design	C_GT_LOC_16	X
Select transceiver to include GTXE2_CHANNEL_X1Y16 in your design	C_GT_LOC_17	X
Select transceiver to include GTXE2_CHANNEL_X1Y17 in your design	C_GT_LOC_18	X
Select transceiver to include GTXE2_CHANNEL_X1Y18 in your design	C_GT_LOC_19	X
Select transceiver to include GTXE2_CHANNEL_X1Y19 in your design	C_GT_LOC_20	X

Table 4-1: Vivado IDE Parameter to User Parameter Mapping<sup>(1)</sup> (Cont'd)

Vivado IDE Parameter/Value	User Parameter/Value	Default Value <sup>(1)</sup>
<b>GT Refclk (MHz)</b>		
GT Refclk1	C_GT_CLOCK_1	GTXQ1
GT Refclk2	C_GT_CLOCK_2	None
<b>Shared Logic</b>		
Include Shared Logic in core	SupportLevel <sup>(8)</sup>	0
Include Shared Logic in example design (default mode)		
Single Ended INIT CLK <sup>(9)(12)</sup>	SINGLEEND_INITCLK	false
Single Ended GTREF CLK <sup>(12)</sup>	SINGLEEND_GTREFCLK	false

**Notes:**

- The values in this table reflect the default device (xc7vx485tffg1157-1). Default values for UltraScale architecture devices are denoted with a slash (/) where appropriate.
- X0Y0 GT selection is based upon columns.
- If a device has transceivers on both sides, *left* is the default value.
- If a 7 series device has GTX transceivers, *gtx* is the default value. If GTH transceivers, *v7gth* is the default value.
- Numbering for the default device starts from GTXE2\_CHANNEL\_X1Y4. Otherwise, numbering starts from GTXE2\_CHANNEL\_X0Y0.
- C\_GT\_LOC\_i where *i* varies from 1 to 48.
- By default, the lowest *i* C\_GT\_LOC\_i is assigned.
- If **Shared Logic in Core** option is selected, SupportLevel is 1.
- Not available in UltraScale devices.
- The Lanes and GT Type options for UltraScale devices are available on the Core Options page in the Vivado IDE.
- Not available in 7 series devices.
- Available if **Include Shared Logic in core** option is selected.
- The GT Refclk selection option is not applicable for line rate > 16.375G core configuration. Defaulted to GTREFCLK0 of each active transceiver Quads reference clocks.

**RECOMMENDED:**

- Do not alter any default locations, unless otherwise absolutely needed after the design is generated, or else the design functionality cannot be guaranteed.
- For UltraScale devices based designs when a line rate of less than 8.0 Gb/s is chosen, the CPLL becomes part of the GT Wizard hierarchical core.

## Output Generation

The customized Aurora 64B/66B core is delivered as a set of HDL source modules in Verilog. These files are arranged in a predetermined directory structure under the project directory name provided to the IP catalog when the project is created. For details, see the *Vivado Design Suite User Guide: Designing with IP* (UG896) [Ref 12].

## Managing Shared Logic Files

You can preview the shared logic files when you select **Shared Logic in Example Design**. You can see this option in IP Sources tab in the Vivado Project Manager along with Synthesis, Simulation filesets, a new fileset for **Shared Logic Files**. These are read only files which can be optionally copied in to the project if you want to use them as part of the project. You can use these files directly instead of taking the additional step of opening example design and then using these additional files. In the IP sources tab, you can right click the Aurora IP which was configured as **Shared Logic in Example Design**, and then select the **Copy Shared Logic into Project...** option to copy these files in to the project hierarchy view.



---

**CAUTION!** *You are cautioned that these shared logic files are read only and when copying them into project view, an additional copy of the same is generated and the ownership is transferred to the project. While using these files, make sure to follow all the sharing guidelines as per the transceiver type.*

---

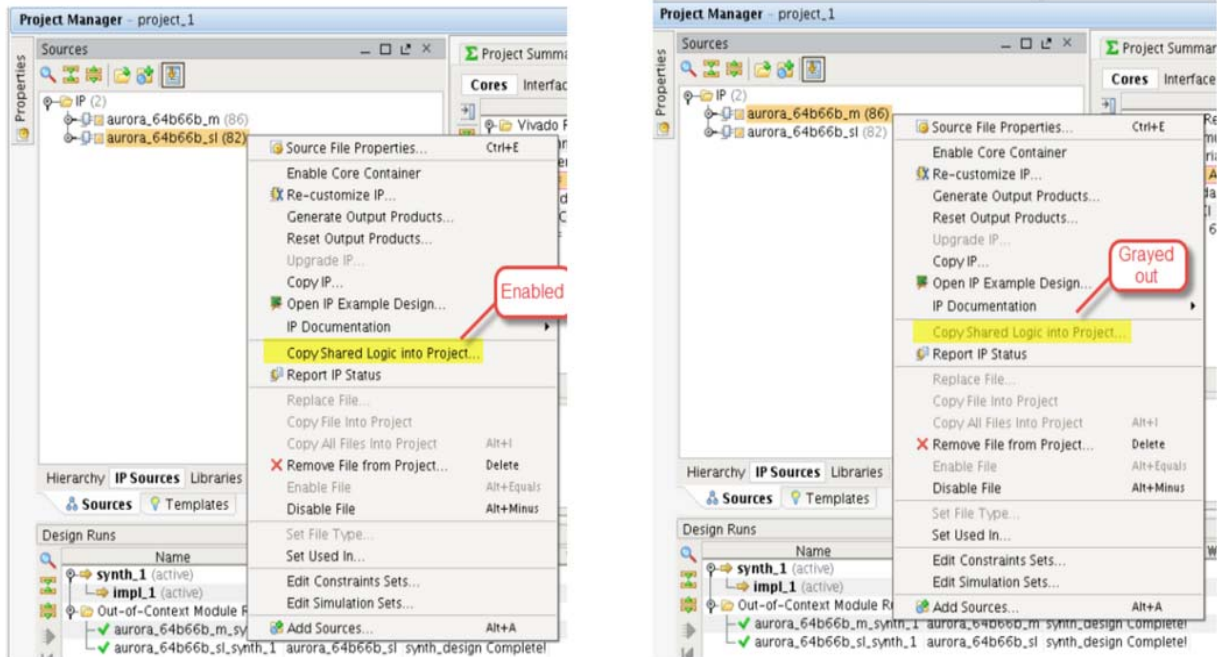

Figure 4-6: Aurora 64B/66B IP Hierarchy view showing Copy Shared Logic into Project

**Note:** Copying shared files in to the project is only for **Shared Logic in Example Design**.

## Constraining the Core

This section contains information about constraining the core in the Vivado Design Suite.

### Device, Package, and Speed Grade Selections

Not Applicable

### Clock Frequencies

Aurora 64B/66B example design clock constraints can be grouped into the following three categories:

- GT reference clock constraint

The Aurora 64B/66B core uses one minimum reference clock and two maximum reference clocks for the design. The number of GT reference clocks is derived based on transceiver selection (that is, lane assignment in the second page of the Vivado IDE). The GT REFCLK value selected in the first page of the Vivado IDE is used to constrain the GT reference clock.

**Note:** The GT reference clock location constraint should be added to the `<user_component_name>_example.xdc` file.

- CORECLK clock constraint

CORECLKs are the clock signals on which the core functions. CORECLKs such as USER\_CLK and SYNC\_CLK are derived from the TXOUTCLK signal which is generated by the transceiver based on the applied reference clock and the transceiver divider settings. The Aurora 64B/66B core calculates the USER\_CLK/SYNC\_CLK frequency based on the line rate and transceiver interface width. The `create_clock` XDC command is used to constrain all CORECLKs.

- INIT CLK constraint

The Aurora 64B/66B example design uses a debounce circuit to sample PMA\_INIT asynchronously clocked by the `init_clk` clock. The `create_clock` XDC command is used to constrain the `init_clk` clock. The `init_clk` frequency value in Vivado IDE is restricted to six decimal places.



---

**RECOMMENDED:** *It is recommended to have the system clock frequency lower than the transceiver reference clock frequency and in the range of 50 to 200 MHz for 7 series and Zynq devices. For UltraScale devices, the recommended range is 6.25 MHz to `line_rate/64` or 200 MHz whichever is less. See *UltraScale Architecture GTH Transceivers User Guide (UG576)* [Ref 5] and *UltraScale Architecture GTY Transceivers User Guide (UG578)* [Ref 6] for more information on valid use models for the free running system clock (`init_clk`).*

---

## Clock Management

Not Applicable

## Clock Placement

Not Applicable

## Banking

Not Applicable

## Transceiver Placement

The `set_property` XDC command is used to constrain the transceiver location. This is provided as a tooltip on the GT Selections tab of the Vivado IDE. A sample XDC is provided for reference.

## I/O Standard and Placement

The positive differential clock input pin (ends with \_P) and negative differential clock input pin (ends with \_N) are used as the transceiver reference clock. The `set_property` XDC command is used to constrain the transceiver reference clock pins.

### False Paths

The False Path constraint is defined on the first stage of the flip-flop of the clock domain crossing (CDC) module.

### Example Design

The generated example design including support logic has a 3.125 Gb/s line rate and a 156.25 MHz reference clock. The XDC file generated for `xc7vx485tffg1157-1`, the default device, follows:

```
##### CLOCK CONSTRAINTS #####
#User Clock Constraint: the value is selected based on the line rate of the module
#create_clock -period 20.48 [get_pins
aurora_64b66b_0_block_i/clock_module_i/user_clk_net_i/I]

# SYNC Clock Constraint
#create_clock -period 10.240 [get_pins
aurora_64b66b_0_block_i/clock_module_i/sync_clock_net_i/I]

##### IP LEVEL CONSTRAINTS START #####
# Following constraints present in aurora_64b66b_0.xdc
# Create clock constraint for TXOUTCLK from GT
#create_clock -period 10.240 [get_pins -hier -filter
{name=~*aurora_64b66b_0_wrapper_i*aurora_64b66b_0_multi_gt_i*aurora_64b66b_0_gtx_in
st/gtxe2_i/TXOUTCLK}]
# Create clock constraint for RXOUTCLK from GT
#create_clock -period 10.240 [get_pins -hier -filter
{name=~*aurora_64b66b_0_wrapper_i*aurora_64b66b_0_multi_gt_i*aurora_64b66b_0_gtx_in
st/gtxe2_i/RXOUTCLK}]
##### IP LEVEL CONSTRAINTS END #####
# Reference clock constraint for GTX
create_clock -period 6.400 [get_ports GTXQ1_P]
### DRP Clock Constraint
create_clock -period 10.000 [get_ports DRP_CLK_IN]

# 50MHz board Clock Constraint
create_clock -period 20.000 [get_ports INIT_CLK_P]

##### No cross clock domain analysis. Domains are not related #####
## set_false_path -from [get_clocks init_clk] -to [get_clocks user_clk]
## set_false_path -from [get_clocks user_clk] -to [get_clocks init_clk]
## set_false_path -from [get_clocks init_clk] -to [get_clocks sync_clk]
## set_false_path -from [get_clocks sync_clk] -to [get_clocks init_clk]

## ## set_false_path -from init_clk -to [get_clocks -of_objects [get_pins
aurora_64b66b_0_block_i/clock_module_i/mmc Adv_inst/CLKOUT0]]
##
```



```

## ## set_false_path -from [get_clocks -of_objects [get_pins
aurora_64b66b_0_block_i/clock_module_i/mmcadv_inst/CLKOUT0]] -to init_clk
##
## ## set_false_path -from init_clk -to [get_clocks -of_objects [get_pins
aurora_64b66b_0_block_i/clock_module_i/mmcadv_inst/CLKOUT1]]
##
## ## set_false_path -from [get_clocks -of_objects [get_pins
aurora_64b66b_0_block_i/clock_module_i/mmcadv_inst/CLKOUT1]] -to init_clk
##
## ## set_false_path -from [get_clocks -of_objects [get_pins
aurora_64b66b_0_block_i/clock_module_i/initclk_bufg_i/O]] -to [get_clocks
-of_objects [get_pins -hier -filter
{name=~*aurora_64b66b_0_i*inst*aurora_64b66b_0_wrapper_i*aurora_64b66b_0_multi_gt_i
*aurora_64b66b_0_gtx_inst/gtxe2_i/RXOUTCLK}]]
##
## ## set_false_path -from [get_clocks -of_objects [get_pins -hier -filter
{name=~*aurora_64b66b_0_i*inst*aurora_64b66b_0_wrapper_i*aurora_64b66b_0_multi_gt_i
*aurora_64b66b_0_gtx_inst/gtxe2_i/RXOUTCLK}]] -to [get_clocks -of_objects [get_pins
aurora_64b66b_0_block_i/clock_module_i/initclk_bufg_i/O]]
##
## ## set_false_path -from [get_clocks -of_objects [get_pins -hier -filter
{name=~*aurora_64b66b_0_i*inst*aurora_64b66b_0_wrapper_i*aurora_64b66b_0_multi_gt_i
*aurora_64b66b_0_gtx_inst/gtxe2_i/RXOUTCLK}]] -to [get_clocks -of_objects [get_pins
aurora_64b66b_0_block_i/clock_module_i/mmcadv_inst/CLKOUT0]]
##
## ## set_false_path -from [get_clocks -of_objects [get_pins
aurora_64b66b_0_block_i/clock_module_i/mmcadv_inst/CLKOUT0]] -to [get_clocks
-of_objects [get_pins -hier -filter
{name=~*aurora_64b66b_0_i*inst*aurora_64b66b_0_wrapper_i*aurora_64b66b_0_multi_gt_i
*aurora_64b66b_0_gtx_inst/gtxe2_i/RXOUTCLK}]]

## GT CLOCK Locations ##
# Differential SMA Clock Connection
set_property LOC AH6 [get_ports GTXQ1_P]
set_property LOC AH5 [get_ports GTXQ1_N]

set_property LOC GTXE2_CHANNEL_X1Y4 [get_cells
aurora_64b66b_0_block_i/aurora_64b66b_0_i/inst/aurora_64b66b_0_wrapper_i/aurora_64b
66b_0_multi_gt_i/aurora_64b66b_0_gtx_inst/gtxe2_i]

# false path constraints to the example design logic
set_false_path -to [get_pins -hier *aurora_64b66b_0_cdc_to*/D]

#####
#####
##Note: User should add LOC based upon the board
# Below LOC's are place holders and need to be changed as per the device and
board

#set_property LOC D17 [get_ports INIT_CLK_P]
#set_property LOC D18 [get_ports INIT_CLK_N]
#set_property LOC G19 [get_ports RESET]
#set_property LOC K18 [get_ports PMA_INIT]

#set_property LOC A20 [get_ports CHANNEL_UP]
#set_property LOC A17 [get_ports LANE_UP]
#set_property LOC Y15 [get_ports HARD_ERR]
#set_property LOC AH10 [get_ports SOFT_ERR]

```

```

#set_property LOC AD16 [get_ports DATA_ERR_COUNT[0]]
#set_property LOC Y19 [get_ports DATA_ERR_COUNT[1]]
#set_property LOC Y18 [get_ports DATA_ERR_COUNT[2]]
#set_property LOC AA18 [get_ports DATA_ERR_COUNT[3]]
#set_property LOC AB18 [get_ports DATA_ERR_COUNT[4]]
#set_property LOC AB19 [get_ports DATA_ERR_COUNT[5]]
#set_property LOC AC19 [get_ports DATA_ERR_COUNT[6]]
#set_property LOC AB17 [get_ports DATA_ERR_COUNT[7]]

#set_property LOC AG29 [get_ports DRP_CLK_IN]
#// DRP CLK needs a clock LOC

##Note: User should add IOSTANDARD based upon the board
# Below IOSTANDARDS are place holders and need to be changed as per the device
and board

#set_property IOSTANDARD DIFF_HSTL_II_18 [get_ports INIT_CLK_P]
#set_property IOSTANDARD DIFF_HSTL_II_18 [get_ports INIT_CLK_N]
#set_property IOSTANDARD LVCMOS18 [get_ports RESET]
#set_property IOSTANDARD LVCMOS18 [get_ports PMA_INIT]

#set_property IOSTANDARD LVCMOS18 [get_ports CHANNEL_UP]
#set_property IOSTANDARD LVCMOS18 [get_ports LANE_UP]
#set_property IOSTANDARD LVCMOS18 [get_ports HARD_ERR]
#set_property IOSTANDARD LVCMOS18 [get_ports SOFT_ERR]
#set_property IOSTANDARD LVCMOS18 [get_ports DATA_ERR_COUNT[0]]
#set_property IOSTANDARD LVCMOS18 [get_ports DATA_ERR_COUNT[1]]
#set_property IOSTANDARD LVCMOS18 [get_ports DATA_ERR_COUNT[2]]
#set_property IOSTANDARD LVCMOS18 [get_ports DATA_ERR_COUNT[3]]
#set_property IOSTANDARD LVCMOS18 [get_ports DATA_ERR_COUNT[4]]
#set_property IOSTANDARD LVCMOS18 [get_ports DATA_ERR_COUNT[5]]
#set_property IOSTANDARD LVCMOS18 [get_ports DATA_ERR_COUNT[6]]
#set_property IOSTANDARD LVCMOS18 [get_ports DATA_ERR_COUNT[7]]

#set_property IOSTANDARD LVCMOS18 [get_ports DRP_CLK_IN]
#// DRP CLK needs a clock IOSTDLOC
    
```

The preceding example XDC is for reference only. This XDC is created automatically when the core is generated from the Vivado design tools.

---

## Simulation

For comprehensive information about Vivado simulation components, as well as information about using supported third-party tools, see the *Vivado Design Suite User Guide: Logic Simulation* (UG900) [Ref 14].



---

**IMPORTANT:** For cores targeting 7 series, Zynq-7000, and UltraScale devices, UNIFAST libraries are not supported. Xilinx IP is tested and qualified with UNISIM libraries only.

---

The Aurora 64B/66B core provides a demonstration test bench for the example design. Simulation status is reported through messages. The TEST COMPLETED SUCCESSFULLY message signifies the completion of the example design simulation.

**Note:** The message `Reached max. simulation time limit` means that simulation was not successful. See [Appendix C, Debugging](#) for more information.

Simulating the duplex core is a single-step process after generating the example design. Simplex core simulation requires partner generation. The partner core is generated automatically and the synthesized netlist is available under the simulation file set when clicking **Open IP Example Design**. Due to the synthesizing of the partner core, opening an example design of a simplex core takes more time than the duplex example design generation.

## Simulation speed up

The `C_EXAMPLE_SIMULATION` parameter is introduced to speed up post synthesis/implementation netlist functional simulations:

1. During the IP Core generation, include the following tcl command to the dict as part of the core generation.

```
set c_example_simulation true
```

**Note:** This mode of IP core generation is only for Simulation purposes. If you intend to test on board, the above command should not be added as part of the IP core generation.

2. If you do not want to set tcl commands during IP core generation and instead edit the code to see the simulation speed up, then change the `EXAMPLE_SIMULATION` parameter in the generated RTL code to 1 in the following file to speed up functional simulations:

- `<USER_COMPONENT_NAME>_exdes.v`
- `<USER_COMPONENT_NAME>_core.v`

---

## Synthesis and Implementation

For information on generating a core and implementing an example design using Quick Start, see [Quick Start Example Design in Chapter 5](#).

For details about synthesis and implementation, see the *Vivado Design Suite User Guide: Designing with IP* (UG896) [\[Ref 12\]](#).

# Example Design

This chapter contains information about the quick start and detailed example designs provided in the Vivado® Design Suite.

---

## Directory and File Contents

See [Output Generation, page 85](#) for the directory structure and file contents of the example design.

---

## Quick Start Example Design

The quick start instructions provide a step-by-step procedure for generating an Aurora 64B/66B core, implementing the core in hardware using the accompanying example design, and simulating the core with the provided demonstration test bench (`demo_tb`). For detailed information about the example design provided with the Aurora 64B/66B core, see [Detailed Example Design](#).

The quick start example design consists of these components:

- An instance of the Aurora 64B/66B core generated using the default parameters
  - Full-duplex with a single GTX transceiver
  - AXI4-Stream user interface
- A top-level example design (`<user_component_name>_exdes`) with an XDC file to configure the core for simple data transfer operation
- A demonstration test bench to simulate two instances of the example design

The Aurora 64B/66B example design has been tested with the Vivado Design Suite for synthesis and the Mentor Graphics Questa Simulator (QuestaSim) for simulation.

## Generating the Core with Quick Start

To generate an Aurora 64B/66B core with default values using the Vivado design tools:

1. Launch the Vivado design tools. For help starting and using the Vivado design tools, see the *Vivado Design Suite User Guide: Designing with IP* (UG896) [Ref 12].
2. Under Quick Start, click **Create New Project** and click **Next**.
3. Enter the new project name and the project location, then Click **Next**.
4. Select **RTL Project** and click **Next**.
5. Click **Next** to accept the default part number (xc7vx485tffg1157-1).
6. Click **Finish**.
7. After creating the project, click **IP catalog** in the Project Manager panel.
8. Locate the Aurora 64B/66B core in the IP catalog.
9. Double-click the core name.
10. Click **OK**.
11. Click **Generate**.

For more detailed information on generating an Aurora 64B/66B core, see *Designing a System Using the Aurora 64B66B Core (Duplex) on the KC705 Evaluation Kit* (XAPP1192) [Ref 15]

## Implementing the Example Design

The example design must be generated from the IP core.

1. Under Sources, Right-click the generated Design Sources file and click **Open IP Example Design...**
2. Enter the path to the directory in which to create the example design and click **OK**.
3. To run synthesis followed by implementation, in the Flow Navigator panel under Implementation, click **Run Implementation**.
4. To generate a bitstream, under Program and Debug, click **Generate Bitstream**.

**Note:** LOC and IO standards must be specified in the XDC file for all input and output ports of the design. The XDC file contains standard LOC and IO constraints in the comments for reference.

For details about synthesis and implementation, see the *Vivado Design Suite User Guide: Designing with IP* (UG896) [Ref 12].

## Detailed Example Design

Each Aurora 64B/66B core includes an example design (<user\_component\_name>\_exdes) that uses the core in a simple data transfer system. For more details about the `example_design` directory, see [Output Generation in Chapter 4](#).

The example design based on the selected configurations consists of the following:

- Frame generator ([FRAME\\_GEN](#)) connected to the TX interface
- Frame checked ([FRAME\\_CHECK](#)) connected to the RX user interface
- VIO/ILA instance for debug and testing
- Hardware-based reset fsm to perform repeat reset and channel integrity testing (only for duplex mode)

[Figure 5-1](#) shows a block diagram of the example design for a full-duplex core. [Table 5-1, page 95](#) describes the ports of the example design.

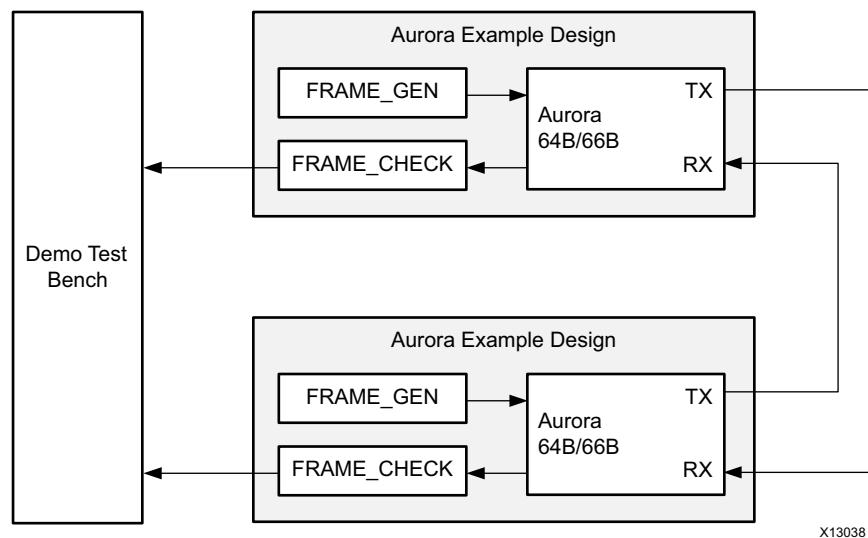

**Figure 5-1: Example Design**

The example design uses all the interfaces of the core. There are separate AXI4-Stream interfaces for optional flow control. Simplex cores without a TX or RX interface have no `FRAME_GEN` or `FRAME_CHECK` block, respectively.

## FRAME\_GEN

This module is used to generate user traffic to each of the AXI4-Stream data, UFC, NFC and USER-K interfaces. The module contains pseudo-random data generated using a linear feedback shift register (LFSR) with a known seed value. The FRAME\_CHECK module can use the same configuration to check the data integrity of the aurora channel. The inputs for this module are `user_clk`, `reset` and `channel_up`. The FRAME\_GEN module follows the AXI4-Stream protocol and transmits the user traffic.

## FRAME\_CHECK

This module is used to check the RX data integrity. As the FRAME\_GEN module uses an LFSR with a known seed value, the same LFSR and seed value are used in the FRAME\_CHECK module to compute the expected frame RX data. The received user data is validated against the expected data and any errors are reported as per the AXI4-Stream protocol. The FRAME\_CHECK module is applicable to the AXI4-Stream data, UFC, NFC and USER-K interfaces.

The design can also be used as a reference for connecting the more complex interfaces on the Aurora 64B/66B core, such as the clocking interface.

When using the example design on a board, be sure to edit the `<component name>_exdes` file in the `example_design` subdirectory to supply the correct pins and clock constraints. [Table 5-1](#) describes the ports available in the example design.

Table 5-1: Example Design I/O Ports

Port	Direction	Clock Domain	Description
<code>rxn[0:m-1]</code>	Input	Serial Clock	Negative differential serial data input pin.
<code>rxp[0:m-1]</code>	Input	Serial Clock	Positive differential serial data input pin.
<code>txn[0:m-1]</code>	Output	Serial Clock	Negative differential serial data output pin.
<code>txp[0:m-1]</code>	Output	Serial Clock	Positive differential serial data output pin.
<code>reset</code>	Input	<code>user_clk</code>	Reset signal for the example design.
<code>&lt;reference clock(s)&gt;</code>	Input	<code>user_clk</code>	The reference clocks for the Aurora 64B/66B core are brought to the top level of the example design. See <a href="#">Reference Clocks for FPGA Designs in Chapter 3</a> for details about the reference clocks.
<code>&lt;core error signals&gt;<sup>(1)</sup></code>	Output	<code>user_clk</code>	The error signals from the Aurora 64B/66B core Status and Control interface are brought to the top level of the example design and registered.

Table 5-1: Example Design I/O Ports (Cont'd)

Port	Direction	Clock Domain	Description
<core channel up signals> <sup>(1)</sup>	Output	user_clk	The channel up status signals for the core are brought to the top level of the example design and registered.
<core lane up signals> <sup>(1)</sup>	Output	user_clk	The lane up status signals for the core are brought to the top level of the example design and registered. Cores have a lane up signal for each GTX and GTH transceiver they use.
pma_init	Input	init_clk	The reset signal for the PCS and PMA modules in the GTX and GTH transceivers is connected to the top level through a debouncer. The signal is debounced using the init_clk. See the Reset section in the <i>7 Series FPGAs GTX/GTH Transceivers User Guide</i> (UG476) [Ref 7] for further details on GT RESET.
init_clk_p/ init_clk_n	Input	-	The init_clk signal is used to register and debounce the PMA_INIT signal. The init_clk signal must not come from a GTX or GTH transceiver, and should be set to a low rate, preferably lower than the reference clock. The init_clk port in the example design is differential-ended for UltraScale™ devices.
data_err_count[0:7]	Output	user_clk	Count of the number of frame data words received by the FRAME_CHECK that did not match the expected value.
ufc_err	Output	user_clk	Asserted (active-High) when UFC data words received by the FRAME_CHECK that did not match the expected value.
user_k_err	Output	user_clk	Asserted (active-High) when USER-K data words received by the FRAME_CHECK that did not match the expected value.

**Notes:**

1. See [Status, Control and the Transceiver Interface in Chapter 2](#) for details.



---

## Using Vivado Lab Tools

The integrated logic analyzer (ILA) and VIO cores aid in debugging and validating the design in the board and are provided with the Aurora 64B/66B core. The Aurora 64B/66B core connects the relevant signals to the VIO to facilitate easier bring-up or debug of the design. Select the **Vivado Lab Tools** option from the Core Options tab in the Vivado Integrated Design Environment (IDE) (see [Figure 4-1, page 72](#)) to include it as a part of the example design.

Cores generated with the Vivado lab tools option enabled have three VIO interfaces and one ILA interface.

- vio1\_inst – contains core Lane Up, Channel Up, Data Error count, Soft Error count, Channel Up transition count along with System Reset, GT Reset and Loopback ports
- vio2\_inst – contains status of reset quality counters
- vio3\_inst – contains test pass/fail status for repeat reset test
- i\_ila – contains core status signals like `hard_err`, `soft_err`, `channel_up`, `lane_up`, and `data_err` and the first 16 bits of tx and rx data.

---

## Implementing the Example Design

The example design must be generated from the IP core. See [Implementing the Example Design](#) earlier in this chapter.

---

## Hardware Reset FSM in the Example Design

The Aurora 64B/66B core example design for duplex mode incorporates a hardware reset FSM to perform repeated resets and monitoring robustness of the link. This FSM also contains an option to set different time periods between reset assertions. Also continuous `channel_up` and `link_reset` transition counters are monitored and the test status is reported through VIO.

The following signals are added in to the default ILA and VIOs for probing the link:

i\_ila:

- `tx_d_i[0:15]`: TX Data from the LocalLink Frame Gen module
- `rx_d_i[0:15]`: RX Data to the LocalLink Frame check module

- `data_err_count_o`: 8-bit Data error count value, it is expected to be 'd0 in normal operations
- `lane_up_vio_usrclk`: `lane_up` signal
- `channel_up_i`: `channel_up` signal
- `soft_err_i`: Soft error monitor
- `hard_err_i`: Hard error monitor

`vio1_inst`:

- `sysreset_from_vio_i`: Reset input to example design
- `gtreset_from_vio_i`: `pma_init` to example design
- `vio_probe_in2`: Quality counters for Link status
- `rx_cdovrden_i`: Used while enabling loopback mode
- `loopback_i`: Used while enabling loopback mode

`vio2_inst`:

- `reset_quality_cntrs`: Used to reset all the quality counters in the example design
- `reset_test_fsm_from_vio`: Used to reset the hardware reset test FSM
- `reset_test_enable_from_vio`: Used to enable/start the repeat reset test from the vio ports on the hardware.
- `iteration_cnt_sel_from_vio`: Number of repeat reset iterations to be initiated. This is a 4-bit encoded value for a fixed number of iterations that can be seen in the example design when Vivado lab tools is enabled.
- `lnk_reset_in_initclk`: Input probe to monitor the assertion of `link_reset`
- `soft_err_in_initclk`: Input probe to monitor the `soft_err` status
- `chan_up_transcnt_20bit_i [15:8]`: Number of `channel_up` transaction counts; this can be used to monitor the number of reset iterations that have been completed.

**Note:**

- a. `chan_up_transcnt_20bit_i` is probed only [15:8] bits; hence, this probe takes some time to update the status.
- b. To change the number of reset iterations, modify the respective value for `iteration_cnt_sel_from_vio` and correspondingly select `chan_up_transcnt_20bit_i` to probe the status.

vio3\_inst:

- `test_passed_r`: Test pass status is asserted after the respective iteration count if resets are done successfully.
- `test_failed_r`: Test fail status is asserted if there is either a lack of `channel_up` or some data errors have occurred.
- `lnkrst_cnt_20bit_vio_i`: Probe to monitor the number of times the `link_reset` is asserted.
- `reset_test_fsm_chk_time_sel`: 3-bit encoded value probe to select the hardware `reset_fsm` check time for `channel_up` assertions after reset is deasserted.

Hardware FSM Operation:

In the example design (`<user_component_name>_exdes.v`), a hardware initiated repeat reset FSM has been added to test the robustness of the link when subject to repeat reset. The FSM consists of IDLE, ASSERT\_RST, DASSERT\_RST, WAIT, WAIT1, CHECK, FAIL and DONE states.

1. In IDLE state, `test_passed_r` indicates reset test passed, `test_failed_r` indicates reset test fail, and `timer_r` provides an iteration count of resets. Defaults to 0.
2. When the `reset_test_enable_from_vio` signal is asserted, the hardware FSM traverses to the ASSERT\_RST state where `pma_init` is asserted for a pre-determined time (28-bit count time).
3. This `pma_init` assertion ensures that a hot plug sequence is detected by the link partner. The hardware FSM then traverses to the DEASSERT\_RST state where the `pma_init` is deasserted and the timer is loaded with a default value that can be configured using the `reset_test_fsm_chk_time_sel` vio signal.
4. The FSM then moves to the WAIT state until the selected time has expired. In this state, all checks such as for data errors and soft error occurrences are performed and the `channel_up` signal is verified to be asserted High and not toggled more than once for this iteration of `pma_init`.
5. If this condition is not met, the FSM moves to FAIL state and the repeat reset run is stopped. Otherwise, the FSM moves to WAIT1 state where a few data packets are transmitted and received.
6. The FSM then moves to the CHECK state, in which the `channel_up` transitions are checked again. If there is not more than one transition, the FSM returns to the IDLE state until the requested iterations are completed. This ensures that the link is robust and recovers reliably across multiple repeat resets of the link.

# Test Bench

The Aurora 64B/66B core delivers a demonstration test bench for the example design. This chapter describes the Aurora 64B/66B test bench and its functionality. The test bench consist of the following modules:

- Device Under Test (DUT)
- Clock and reset generator
- Status monitor

The Aurora 64B/66B test bench components can change based on the selected Aurora 64B/66B core configurations, but the basic functionality remains the same for all of the core configurations.

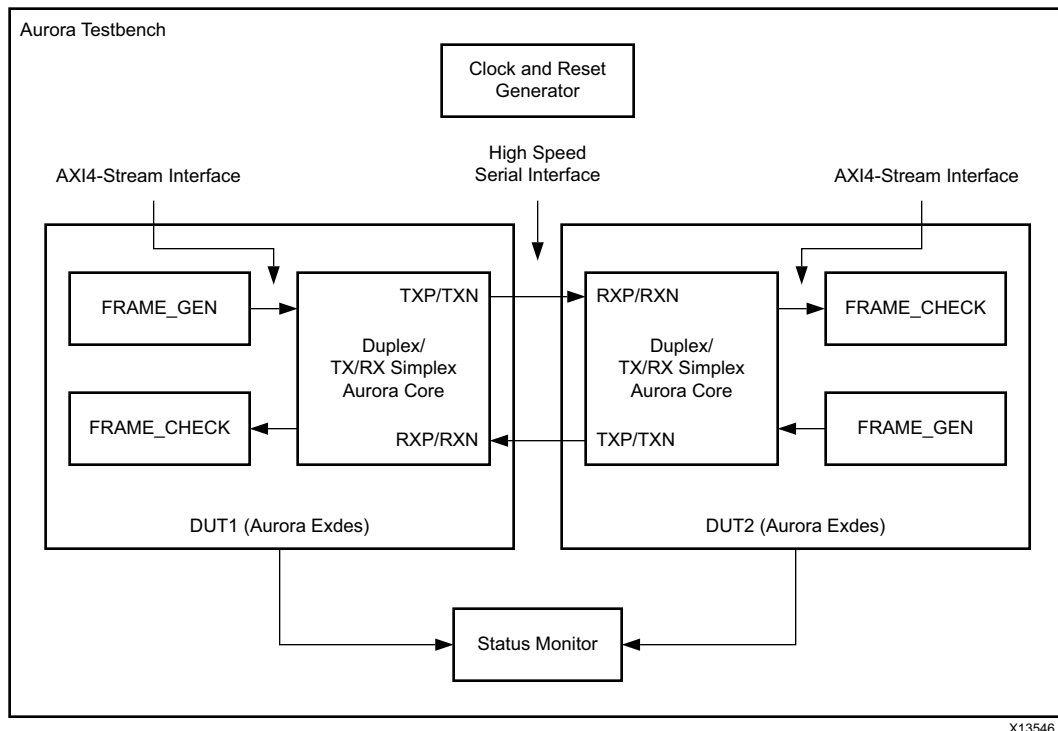

Figure 6-1: Aurora 64B/66B Test Bench for Duplex Configuration

The Aurora 64B/66B test bench environment connects the Aurora 64B/66B duplex/TX/RX simplex core in loopback using a high-speed serial interface. Figure 6-1 shows the Aurora 64B/66B test bench for the duplex/TX/RX simplex configuration.

The test bench looks for the state of the channel, then the integrity of the user data, UFC data, and user-K blocks for a predetermined simulation time. The `channel_up` assertion message indicates that link training and channel bonding (in case of multi-lane designs) are successful. The counter is maintained in the FRAME\_CHECK module to track the reception of erroneous data. The test bench flags an error when erroneous data is received.

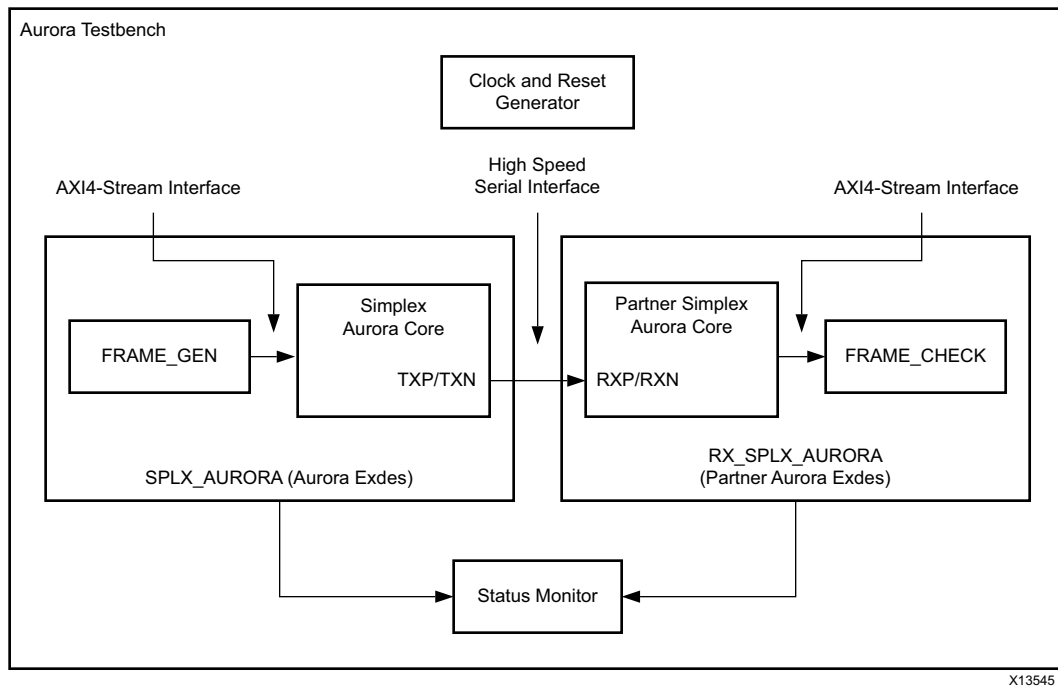

Figure 6-2: Aurora 64B/66B Test Bench for Simplex Configuration

The Aurora 64B/66B test bench environment connects the Aurora 64B/66B simplex core to the partner simplex Aurora 64B/66B core using the high-speed serial interface. Figure 6-2 shows the Aurora 64B/66B test bench for the simplex configuration where DUT1 is configured as TX-only simplex and DUT2 is configured as RX-only simplex.

The test bench looks for the state of the transmitter and receiver channels and then checks the integrity of the user data for a predetermined simulation time. The `tx_channel_up` and `rx_channel_up` assertion messages indicate that link training and channel bonding (in case of multi-lane designs) are successful.

## Verification, Compliance, and Interoperability

This appendix provides details about how this IP core was tested for compliance.

Aurora 64B/66B cores are verified for protocol compliance using an array of automated hardware and simulation tests. The core comes with an example design implemented using a linear feedback shift register (LFSR) for understanding and verification of the core features.

Aurora 64B/66B cores are tested in hardware for functionality, performance, and reliability using Xilinx evaluation boards. Aurora 64B/66B verification test suites for all possible modules are continuously being updated to increase test coverage across the range of possible parameters for each individual module.

A series of test scenarios are validated using various Xilinx development boards which are listed in [Table A-1](#). These boards can be used to prototype system designs and the core can be used to communicate with other systems.

**Table A-1: Xilinx Development Boards**

Target Device	Evaluation Boards	Characterization boards
7 series FPGAs	KC705, VC707, VC709, ZC706	KC724, VC7203, VC7215, ZC723
UltraScale™ architecture	KCU105, VCU108	UC1250, UC1283, UC1287

To achieve interoperability among different versions of Aurora 64B/66B cores for 7 series FPGA transceivers, a user-level parameter is provided which must be set to achieve proper interoperability between cores as shown in [Table A-2](#). [Table A-3](#) shows the interoperability between 2015.1 (7 series FPGAs) with 2015.1 (UltraScale™ FPGAs) of the Aurora 64B/66B core.

Table A-2: Aurora 64B/66B Interoperability

<b>2014.1 (7 series FPGAs) Interoperability with 2013.2 (7 series FPGAs) of Aurora 64B/66B</b>		
<b>2014.1\2013.2</b>	<b>2013.2 (7 series) GTX Transceivers</b>	<b>2013.2 (7 series) GTH Transceivers</b>
2014.1 (7 series) GTX transceivers	√	√
2014.1 (7 series) GTH transceivers	√	√
<b>2014.1 (7 series) Interoperability with ISE 14.7 (6 series) of Aurora 64B/66B</b>		
<b>2014.1\ISE 14.7</b>	<b>ISE 14.7 (6 series) GTX Transceivers</b>	<b>ISE 14.7 (6 series) GTH Transceivers</b>
2014.1 (7 series) GTX transceivers	√	x
2014.1 (7 series) GTH transceivers	√	x

To handle backward compatibility with earlier core versions, three parameters, BACKWARD\_COMP\_MODE1, BACKWARD\_COMP\_MODE2 and BACKWARD\_COMP\_MODE3 are included in the <user\_component\_name>\_core.v module. These parameters allow 2014.1 (7 series FPGAs) core versions to provide the characteristics and functionality of previous versions of the core. These parameters were created to conveniently handle the condition where updates to the previous core versions are not practical. Hence, the overall stability of the linked system (new <-> old) is equivalent to the stability of links achievable between previous core versions (old <-> old) as shown in [Table A-2](#).

#### BACKWARD\_COMP\_MODE1 /BACKWARD\_COMP\_MODE2

- Default value is 0. This ensures compatibility between 2014.1 (7 series FPGAs) core and 2013.4 (7 series FPGAs) core and between 2014.1 (7 series FPGAs) core and 2013.3 (7 series FPGAs) core.
- Set both these parameters to 1 to make the 2014.1 (7 series FPGAs) core compatible with the 2013.2 (7 series FPGAs) core or with the ISE 14.7 (6 series) core.

#### BACKWARD\_COMP\_MODE3

- Default value is 0. Set this parameter to 1 (from 2014.3 (7 series FPGAs) core) if the core needs to clear the hot plug counter on reception of any valid BTF. When this parameter is 0, the hot-plug counter is only cleared by reception of CC blocks.

Table A-3: 2015.1 Aurora 64B/66B Interoperability

<b>2015.1 (7-series FPGAs) Interoperability with 2015.1 (UltraScale FPGAs) of Aurora 64B66B</b>	
	<b>2015.1 GTH UltraScale Transceivers</b>
2015.1 (7-series) GTH Transceivers	√
2015.1 (7-series) GTX Transceivers	√

GTY transceiver based Aurora core is not interoperability tested with any other GT types in this version of the core release.

# Migrating and Upgrading

This appendix contains information about upgrading to a more recent version of the IP core and migrating legacy (LocalLink based) Aurora 64B/66B Cores to the AXI4-Stream Aurora 64B/66B Core.

For customers upgrading in the Vivado® Design Suite, important details (where applicable) about any port changes and other impacts to user logic are included.

---

## Device Migration

If migrating from a 7 series device with GTX or GTH transceivers to an UltraScale™ device with GTH transceivers, the prefixes of the optional transceiver debug ports for single-lane cores are changed from "gt0", "gt1" to "gt", and the suffix "\_in" and "\_out" are dropped. For multi-lane cores, the prefixes of the optional transceiver debug ports gt(n) are aggregated into a single port. For example: gt0\_gtrxreset and gt1\_gtrxreset now become gt\_gtrxreset [1:0]. This is true for all ports, with the exception of the DRP buses which follow the convention of gt (n) \_drpxyz.



**IMPORTANT:** *It is important that designs are updated to use the new transceiver debug port names. For more information about migration to UltraScale devices, see the UltraScale Architecture Migration Methodology Guide (UG1026) [Ref 16]*

---



## Upgrading in the Vivado Design Suite

This section provides information about any changes to the user logic or port designations that take place when you upgrade to a more current version of this IP core in the Vivado Design Suite.

In the latest revision of the core, there have been several changes which make the core pin-incompatible with previous versions. These changes were required as part of the general one-off hierarchical changes to enhance the customer experience.

### Shared Logic

As part of the hierarchical changes to the core, it is now possible to have the core itself include all of the logic which can be shared between multiple cores, which was previously exposed in the example design for the core.



**RECOMMENDED:** *If upgrading to a later core version with shared logic, there is no simple upgrade path and it is recommended that you consult the Shared Logic sections of this document for more guidance.*

### Changes from v11.0 to v11.1

Added GTYE4 transceiver support and also added `gt_rxusrclk_out` transceiver debug output.

### Changes from v10.0 to v11.0

Added GTYE3 transceiver support.

### Changes from v9.3 to v10.0

Table B-1 explains the interfaces and ports updating (addition and removal) in v10.0 of the Aurora 64B/66B core and provides guidance on the impact of these port additions on designs using pre cores.

Table B-1: New Ports Added to Aurora 64B/66B in 2015.1

Port	Direction	Clock Domain	Description
reset/ tx_reset/ rx_reset	Input	user_clk	This is used internally in the core.
reset2fg	Output	user_clk	Available in simplex cores. Used to reset the Frame Generator only.

Table B-1: New Ports Added to Aurora 64B/66B in 2015.1

Port	Direction	Clock Domain	Description
reset2fx	Output	user_clk	Available in simplex cores. Used to reset the Frame Checker only.
gt_pcsrsvdin	Input	async	Optional Transceiver Debug port added.
gt<lane>_txinhibit/ gt_txinhibit	Input	user_clk	Optional Transceiver Debug port added.
do_cc	Input	user_clk	This port is now removed because the standard CC module is part of the core.

**Notes:**

- Flow control AXI ports are grouped into respective AXI4-Stream interfaces; control and status ports are grouped into display interfaces.

When IP is upgraded, critical warnings occur due to these port additions. As Ease of Use enhancements to the core the `reset/ tx_reset/ rx_reset` ports are now connected inside the core. Similarly the `do_cc` port is removed because the standard `cc` module is now part of the core. The removal of these two ports does not interfere with basic functionality.

## Updates in the v9.0 Core

- In the TX Startup FSM, the prior counting mechanism for `mmcm_lock_count` was based on `txuserclk`. Limitations resulted because this was a recovered clock. `stable_clock` is now used for the MMCM Lock synchronization.
- The RX datapath is now 32 bits up to the CBCC module, thus avoiding width conversion logic and `clk_en` generation. These functions are handled in the CBCC module before writing data to the FIFO.
- Logic added to detect polarity inversion and to invert polarity while lane init is enabled.
- The core internally generates `tx_channel_up` for Aurora 64B/66B TX logic and `rx_channel_up` for Aurora 64B/66B RX logic. This action ensures that the RX logic is active and ready to receive before the TX logic begins sending. `rx_channel_up` is presented as `channel_up`.
- Reset and controls are common across all lanes.
- The RX CDR lock time was increased from 50 KUI to 37 MUI as suggested by the transceiver user guide.
- The Block Sync header max count was increased from 64 to 60,000 to improve the robustness of the link.
- Allowed transmission of more idle characters during channel initialization to improve robustness of the link.
- Removed the scrambler reset making it free running to achieve faster CDR lock. The default pattern sent by the scrambler is the scrambled value of NA idle character.

- Updated the GTH transceiver QPLL attributes - See AR [56332](#).
- Added shared logic and optional transceiver control and status debug ports.
- Updated clock domain crossing synchronizers to increase Mean Time Between Failures (MTBF) from meta-stability. Currently using a common synchronizer module and applying false path constraints only for the first stage of the flops.
- Added support for Cadence IES and Synopsys VCS simulators.
- Added Vivado lab tools support for debug.
- Added quality counters in the example design to increase the test quality.
- Added a hardware reset state machine in the example design to perform repeat reset testing.

---

## Migrating Legacy (LocalLink based) Aurora 64B/66B Cores to the AXI4-Stream Aurora 64B/66B Core

### Prerequisites

- Vivado design tools build containing the Aurora 64B/66B v9.x core supporting the AXI4-Stream protocol
- Familiarity with the Aurora 64B/66B directory structure
- Familiarity with running the Aurora 64B/66B example design
- Basic knowledge of the AXI4-Stream and LocalLink protocols
- Latest product guide (PG074) of the core with the AXI4-Stream updates
- Legacy documents: *LogiCORE IP Aurora 64B/66B 64B/66B v4.2 Data Sheet (DS528)* [[Ref 17](#)], *LogiCORE IP Aurora 64B/66B v4.1 Getting Started Guide (UG238)* [[Ref 18](#)], and *LogiCORE IP Aurora 64B/66B v4.2 User Guide (UG237)* [[Ref 19](#)] for reference.
- Migration guide (this Appendix)

### Overview of Major Changes

The major changes to the core is the addition of the AXI4-Stream interface:

- Max line rate support of 16.375G added for UltraScale GTHE3/GTHE4 transceivers.
- Extended the Max line rate support of up to 25.7813G for GTYE3/GTYE4 transceivers.
- Line rate value restricted to four decimal digits for UltraScale and UltraScale+ devices with the exception of 25.78125 Gb/s for GTY devices.
- GT location selection option for UltraScale device added to the core.

- Added support for simplex auto recovery.
- Flow control ports grouped into AXI4-Stream interfaces.
- Control and Status ports are grouped into display interfaces.
- Single-ended clock option added to the core for `init_clk` and `gt_refclk`.
- Both reset inputs `pma_init` and `reset_pb` made asynchronous. The `reset`, `tx_reset` and `rx_reset` input ports were removed.
- CRC resource utilization optimized.
- Standard CC module made part of the IP. The `do_cc` port was removed.
- INIT clock frequency value can take up to six decimal digits.

## Block Diagrams

Figure B-1 shows an example Aurora 64B/66B design using the legacy LocalLink interface.

Figure B-2 shows an example Aurora 64B/66B design using the AXI4-Stream interface.

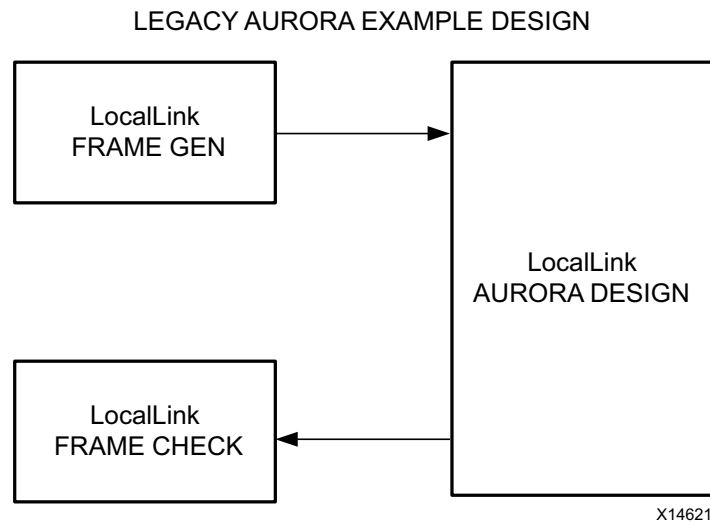

Figure B-1: **Legacy Aurora 64B/66B Example Design**

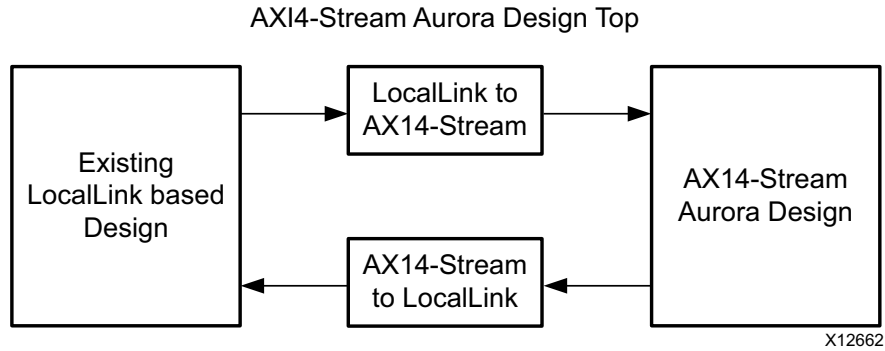

Figure B-2: AXI4-Stream Aurora 64B/66B Example Design

## Signal Changes

Table B-2: Interface Changes

LocalLink Name	AXI4-S Name	Difference
TX_D	s_axi_tx_tdata	Name change only
TX_REM	s_axi_tx_tkeep	Name change. For functional differences, see <a href="#">Table 2-2, page 12</a>
TX_SOF_N		Generated Internally
TX_EOF_N	s_axi_tx_tlast	Name change; Polarity
TX_SRC_RDY_N	s_axi_tx_tvalid	Name change; Polarity
TX_DST_RDY_N	s_axi_tx_tready	Name change; Polarity
UFC_TX_REQ_N	ufc_tx_req	Name change; Polarity
UFC_TX_MS	ufc_tx_ms	No Change
UFC_TX_D	s_axi_ufc_tx_tdata	Name change only
UFC_TX_SRC_RDY_N	s_axi_ufc_tx_tvalid	Name change; Polarity
UFC_TX_DST_RDY_N	s_axi_ufc_tx_tready	Name change; Polarity
NFC_TX_REQ_N	s_axi_nfc_tx_tvalid	Name change; Polarity
NFC_TX_ACK_N	s_axi_nfc_tx_tready	Name change; Polarity
NFC_PAUSE	s_axi_nfc_tx_tdata	Name change.
NFC_XOFF		For signal mapping, see <a href="#">Table 2-7, page 26</a>
USER_K_DATA	s_axi_user_k_tdata	Name change.
USER_K_BLK_NO		For signal mapping, see <a href="#">Table 2-9, page 33</a>
USER_K_TX_SRC_RDY_N	s_axi_user_k_tx_tvalid	Name change; Polarity
USER_K_TX_DST_RDY_N	s_axi_user_k_tx_tready	Name change; Polarity
RX_D	m_axi_rx_tdata	Name change only
RX_REM	m_axi_rx_tkeep	Name change. For functional difference, see <a href="#">Table 2-2, page 12</a>
RX_SOF_N		Removed
RX_EOF_N	m_axi_rx_tlast	Name change; Polarity

Table B-2: Interface Changes (Cont'd)

LocalLink Name	AXI4-S Name	Difference
RX_SRC_RDY_N	m_axi_rx_tvalid	Name change; Polarity
UFC_RX_DATA	m_axi_ufc_rx_tdata	Name change only
UFC_RX_REM	m_axi_ufc_rx_tkeep	Name change For functional difference, see <a href="#">Table 2-8, page 29</a>
UFC_RX_SOF_N		Removed
UFC_RX_EOF_N	m_axi_ufc_rx_tlast	Name change; Polarity
UFC_RX_SRC_RDY_N	m_axi_ufc_rx_tvalid	Name change; Polarity
RX_USER_K_DATA	m_axi_rx_user_k_tdata	Name change For functional difference, see <a href="#">Table 2-9, page 33</a>
RX_USER_K_BLK_NO		
RX_USER_K_SRC_RDY_N	m_axi_rx_user_k_tvalid	Name change; Polarity

## Migration Steps

Generate an AXI4-Stream Aurora 64B/66B core from the Vivado design tools.

### *Simulate the Core*

1. Run simulation from the Vivado IDE. Select simulation type to launch.
2. QuestaSim launches and compiles the modules.
3. The `wave_mti.do` file loads automatically and populates AXI4-Stream signals.
4. Allow the simulation to run. This might take some time.
  - a. Initially lane up is asserted.
  - b. Channel up is then asserted and the data transfer begins.
  - c. Data transfer from all flow control interfaces now begins.
  - d. Frame checker continuously checks the received data and reports for any data mismatch.
5. A 'TEST PASS' or 'TEST FAIL' status is printed on the QuestaSim console providing the status of the test.

### *Implement the Core*

1. Click **Run Implementation** to run synthesis and implementation consecutively.

### ***Integrate to an Existing LocalLink-based Aurora 64B/66B Design***

1. The Aurora 64B/66B core provides a lightweight 'shim' to interface to any existing LL based interface. The shims are delivered along with the core from the `aurora_64b66b_v8_0` version of the core.
2. See [Figure B-2, page 109](#) for the emulation of a LL Aurora 64B/66B core from a AXI4-Stream Aurora 64B/66B core.
3. Two shims `<user_component_name>_ll_to_axi.v` and `<user_component_name>_axi_to_ll.v` are provided in the `src` directory of the AXI4-Stream Aurora 64B/66B core.
4. Instantiate both the shims along with `<user_component_name>.v` in the existing LL based design top.
5. Connect the shim and AXI4-Stream Aurora 64B/66B design as shown in [Figure B-2, page 109](#).
6. The latest AXI4-Stream Aurora 64B/66B core is now usable in any existing LL design environment.

## Vivado IDE Changes

Figure B-3 shows the AXI4-Stream signals in the IP Symbol diagram.

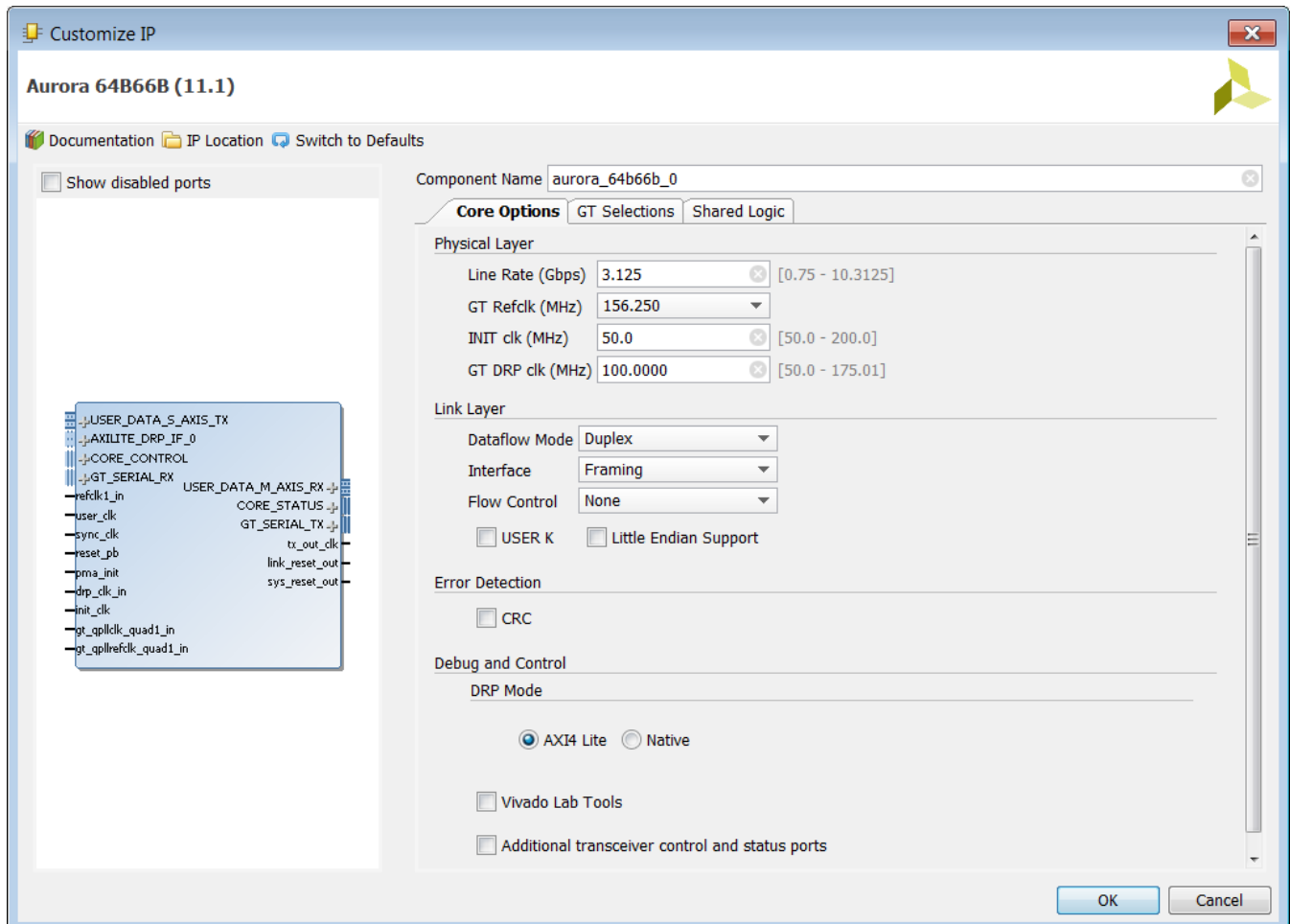

Figure B-3: AXI4-Stream Signals



## Limitations

This section outlines the limitations of the Aurora 64B/66B core for AXI4-Stream support.



---

**IMPORTANT:** *Be aware of the following limitations while interfacing the Aurora 64B/66B core with the AXI4-Stream compliant interface core.*

---

### **Limitation 1:**

The AXI4-Stream specification supports four types of data stream:

- Byte stream
- Continuous aligned stream
- Continuous unaligned stream
- Sparse stream

The Aurora 64B/66B core supports only continuous aligned stream and continuous unaligned stream. The position bytes are valid only at the end of packet.

### **Limitation 2:**

The AXI4-Stream protocol supports transfer with zero data at the end of packet, but the Aurora 64B/66B core expects at least one byte should be valid at the end of packet.

# Debugging

This appendix includes details about resources available on the Xilinx Support website and debugging tools.

---

## Finding Help on Xilinx.com

To help in the design and debug process when using the Aurora 64B/66B core, the [Xilinx Support web page](#) contains key resources such as product documentation, release notes, answer records, information about known issues, and links for obtaining further product support. Also see the [Aurora home page](#).

## Documentation

This product guide is the main document associated with the Aurora 64B/66B core. This guide, along with documentation related to all products that aid in the design process, can be found on the [Xilinx Support web page](#) or by using the Xilinx Documentation Navigator.

Download the Xilinx Documentation Navigator from the [Downloads page](#). For more information about this tool and the features available, open the online help after installation.

To see the available documentation by family, visit the [Xilinx Support web page](#).

To see the available documentation by solution:

1. Visit [the Xilinx Support web page](#).
2. Select the Documentation tab located at the top of the web page.

This is the Documentation Center where Xilinx documentation is sorted by Devices, Boards, IP, Design Tools, Doc Type, and Topic.

## Solution Centers

See the [Aurora Solutions Center](#) for support specific to the Aurora 64B/66B core. Also, see [GT\\_Debug\\_Flowchart](#) for transceiver debugging mentioned in the following Answer Record

AR: [57237](#)

## Answer Records

Answer Records include information about commonly encountered problems, helpful information on how to resolve these problems, and any known issues with a Xilinx product. Answer Records are created and maintained daily ensuring that users have access to the most accurate information available.

Answer Records for this core can be located by using the Search Support box on the main [Xilinx support web page](#). To maximize your search results, use proper keywords such as

- Product name
- Tool message(s)
- Summary of the issue encountered

A filter search is available after results are returned to further target the results.

To use the Answers Database Search:

3. Enter keywords in the provided search field and select Search.
  - Examples of searchable keywords are product names, error messages, or a generic summary of the issue encountered.
  - To see all answer records directly related to the Aurora 64B/66B core, search for the phrase "Aurora 64B66B"

### **Master Answer Record for the Aurora 64B/66B Core**

AR: [54368](#)

Xilinx provides premier technical support for customers encountering issues that require additional assistance.

## Technical Support

Xilinx provides technical support at the [Xilinx Support web page](#) for this LogiCORE™ IP product when used as described in the product documentation. Xilinx cannot guarantee timing, functionality, or support if you do any of the following:

- Implement the solution in devices that are not defined in the documentation.

- Customize the solution beyond that allowed in the product documentation.
- Change any section of the design labeled DO NOT MODIFY.

To contact Xilinx Technical Support, The XCI file created during Aurora 64B/66B core generation

## Vivado Design Suite Debug Feature

The Vivado Design Suite debug feature inserts logic analyzer and virtual I/O cores directly into your design. The debug feature also allows you to set trigger conditions to capture application and integrated block port signals in hardware. Captured signals can then be analyzed. This feature in the Vivado IDE is used for logic debugging and validation of a design running in Xilinx.

## Simulation Debug

### Lanes and Channel Do Not Come Up in Simulation

- The quickest way to debug this issue is to view the signals from one of the GTX or GTH transceiver instances that is not working.
- Ensure that the reference clock and user clocks are all toggling.
 

**Note:** Only one of the reference clocks should be toggling, The rest are tied Low.
- Check to see that `recclk` and `txoutclk` are toggling. If they are not toggling, it might be necessary to wait longer for the PMA to finish locking. Wait for lane up and channel up. It might be necessary to wait longer for simplex/7 series FPGA designs.
- Ensure that `txn` and `txp` are toggling. If they are not, make sure to wait long enough (see the previous bulleted item) and make sure that another signal is not driving the `txn/txp` signal.
- Check in the `<user_component_name>_support` module whether the `pll/mmcn_not_locked` signal and the `reset` signals are present in the design. If these are being held active, the Aurora 64B/66B module cannot initialize.
- Ensure that the `power_down` signal is not being asserted.
- Ensure that the `txn` and `txp` signals from each GTX or GTH transceiver are connected to the appropriate `rxn` and `rxp` signals from the corresponding GTX or GTH transceiver on the other side of the channel

- Instantiate the "glbl" module and use it to drive the `power_up` reset at the beginning of the simulation to simulate the reset that occurs after configuration. Hold this reset for a few cycles. The following code can be used as an example:

```
//Simulate the global reset that occurs after configuration at the beginning
//of the simulation.
assign glbl.GSR = gsr_r;
assign glbl.GTS = gts_r;

initial
begin
    gts_r = 1'b0;
    gsr_r = 1'b1;
    #(16*CLOCKPERIOD_1);
    gsr_r = 1'b0;
end
```

- If using a multilane channel, make sure all of the transceivers on each side of the channel are connected in the correct order.

## Channel Comes Up in Simulation But `s_axi_tx_tready` is Never Asserted (Never Goes High)

- If the module includes flow control but it is not being used, make sure the request signals are not currently driven High. `s_axi_nfc_tx_tvalid` and `ufc_tx_req` are active-High: if they are High, `s_axi_tx_tready` stays Low because the channel is allocated for flow control.
- If the module includes USER-K blocks but they are not being used, make sure the `s_axi_user_k_tx_tvalid` is not driven High. If it is High, `s_axi_tx_tready` stays Low as channel is allocated for USER-K Blocks.
- If NFC is enabled, make sure the design on the other side of the channel did not send an NFC XOFF message. This cuts off the channel for normal data until the other side sends an NFC XON message to turn the flow on again.

## Bytes and Words Are Being Lost As They Travel Through the Aurora 64B/66B Channel

- If using the AXI4-Stream interface, make sure to write data correctly. The most common mistake is to assume words are written without looking at `s_axi_tx_tready`. Also remember that the `s_axi_tx_tkeep` signal must be used to indicate which bytes are valid when `s_axi_tx_tlast` is asserted.
- Ensure to read correctly from the RX interface. Data and framing signals are only valid when `m_axi_rx_tvalid` is asserted.

## Problems While Compiling the Design

Ensure to include all the files from the `src` directory when compiling. Check if the simulator and libraries are set up properly. Check if the simulator language is set to **mixed**.

## Next Step

Open a support case to have the appropriate Xilinx expert assist with the issue.

To create a technical support case, see the [Xilinx Service Portal web page](#).

Items to include when opening a case:

- Detailed description of the issue
- Results of the steps listed previously
- Attach a value change dump (VCD) or wave log format (WLF) dump of the observation.
- Attach the XCI/XCO file from the IP.
- If any modifications are updated to the IP generated out of Vivado and reasons for doing the changes.
- The `.ila` dump of the Hardware captures optionally, if available.

---

## Hardware Debug

Most fields in the Vivado® Integrated Design Environment (IDE) have tool tips serving as guidelines to properly configure and generate the core.

Observe and follow all RECOMMENDED and IMPORTANT notes in product guides.

As the transceiver is the critical building block in the Aurora 64B/66B core, debugging and ensuring proper operation of the transceiver is extremely important. [Figure C-1](#) shows the steps involved for debugging transceiver-related issues.



**IMPORTANT:** *Ensure that the serial transceiver attributes are updated. See [Appendix D, Generating a GT Wrapper File from the Transceiver Wizard](#) for information regarding updating the serial transceiver attribute settings.*

This section provides a debug flow diagram for resolving some of the most common issues. See `GT_Debug_Flowchart` for transceiver debugging mentioned in the following Answer Record

AR: [57237](#)

The Transceiver Debug ports mentioned in [Table 2-11, page 37](#) are operational when you enable the Additional Transceiver Control and Status Ports option in Aurora 64B/66B interface. Refer to Aurora 64B/66B IP Example design for recommended connections for additional transceiver control and status ports in the following guides:

- *7 Series FPGAs GTX/GTH Transceivers User Guide (UG476)*[\[Ref 7\]](#)
- *UltraScale Architecture GTH Transceivers User Guide (UG576)*[\[Ref 5\]](#)
- *UltraScale Architecture GTY Transceivers User Guide (UG578)*[\[Ref 6\]](#)

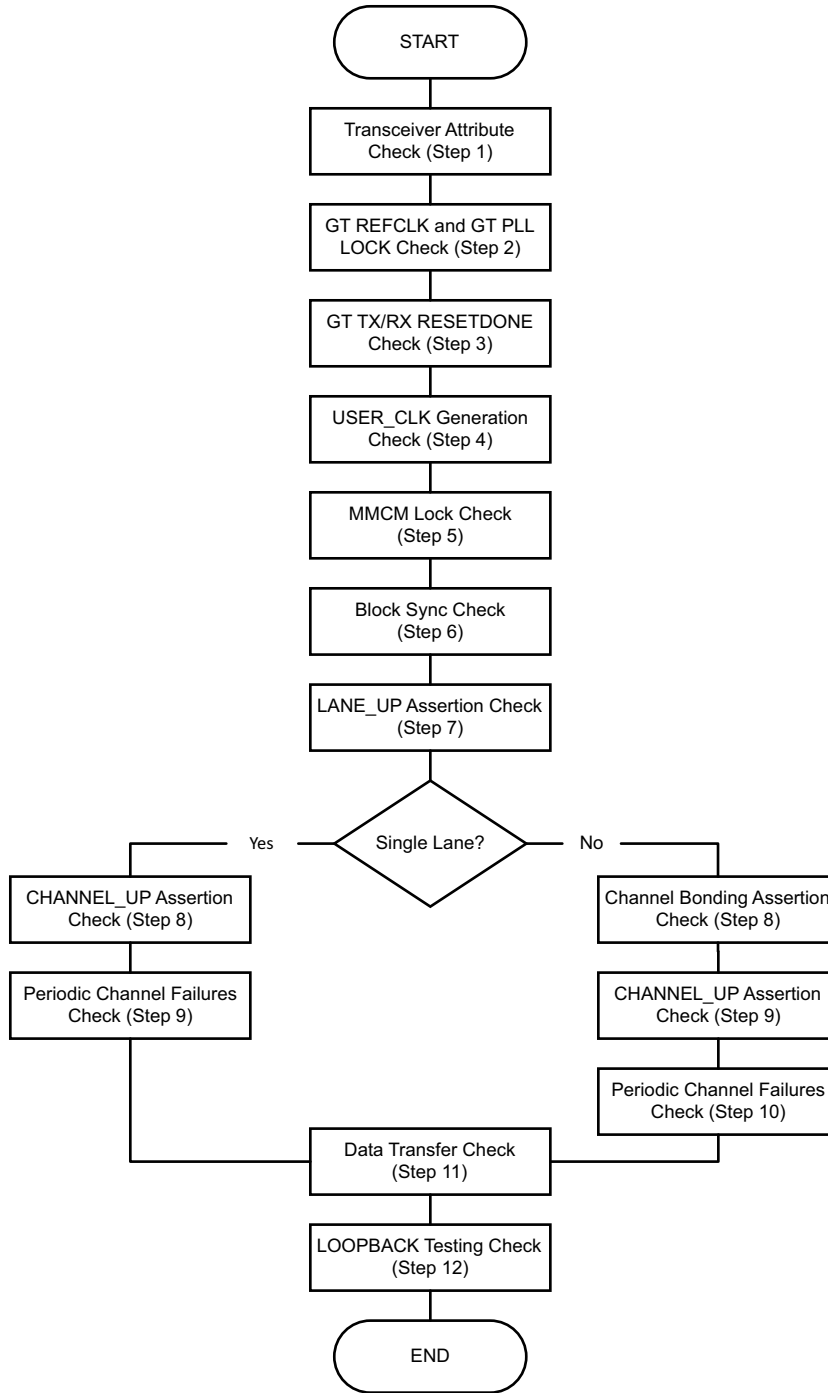

Figure C-1: Transceiver Debug Flow Chart



### 1. Transceiver Attribute Check

Transceiver attributes must match with the silicon version of the device being used on the board. Apply all the applicable workarounds and Answer Records given for the relevant silicon version.

### 2. GT REFCLK and GT PLL LOCK Check

A low-jitter differential clock must be provided as the transceiver reference clock. Ensure that REFCLK location constraints are correct with respect to the board schematics. REFCLK should be active and should meet the phase noise requirements of the transceiver. Ensure that the transceiver locks into the incoming GT REFCLK and asserts the `gt_pll_lock` signal. This signal is available in the Aurora 64B/66B example design. If the `gt_pll_lock` signal is toggling periodically, check if `FSM_RESETDONE` is also toggling. Ensure that the GT PLL attributes are set correctly and that the transceiver generates `txoutclk` with the expected frequency for the given line rate and datapath width options. Note that the Aurora 64B/66B core uses channel PLL/Quad PLL (CPLL/QPLL) in the generated core for GTX or GTH transceivers.

### 3. GT TX/RX RESETDONE Check

The Aurora 64B/66B core uses the sequential reset mode; all of the transceiver components are reset sequentially, one after another. `txresetdone` and `rxresetdone` signals should be asserted at the end of the transceiver initialization. In general, `rxresetdone` assertion takes longer compared to the `txresetdone` assertion. Ensure the `gt_reset` signal pulse width duration matches with the respective transceiver guideline. Probe the signals and FSM states from the RX/TX STARTUP FSM module.

### 4. USER\_CLK Generation Check

The transceiver generates `txoutclk` based on the line rate parameter. The `user_clk` signal is generated from `txoutclk` and the Aurora 64B/66B core uses it as an FPGA logic clock. Check that `user_clk` is generated properly with the expected frequency from `txoutclk`. If the `user_clk` frequency is not in the expected range, check the frequency of the transceiver reference clock and PLL attributes.

### 5. MMCM Lock Check

Aurora 64B/66B cores expect all clocks to be stable. If clocks are generated using an MMCM, ensure the reset inputs are held High until the generated clock is stable. It is recommended to stop the output clock from the MMCM until it is locked. This can be accomplished by using a BUFGCE with the output clock where clock enable (CE) is driven by the MMCM lock output. If the `MMCM_LOCK` signal is toggling periodically, check if the `TX_STARTUP_FSM` is restarting and probe the signals and states of the FSM.

6. BLOCK SYNC Check

See the block sync algorithm described in the *Aurora 64B/66B Protocol Specification* (SP011) [Ref 9] for block sync done.

7. LANE\_UP Assertion Check

Assertion of the `lane_up` signal indicates the communication between the transceiver and its channel partner is established and link training is successful. Enable loopback mode and check for `lane_up` assertions. Bring the `LANE_INIT_SM` module FSM state signals to debug if `lane_up` is not asserted. See the Lane Initialization Procedure in the *Aurora 64B/66B Protocol Specification* (SP011) [Ref 9] for `lane_up` assertion details.

Single Lane:

8. CHANNEL\_UP Assertion Check

The criteria for `channel_up` signal assertion are the verification sequence (defined in the Aurora 64B/66B protocol) being transferred between channel partners, and the successful reception of four verification sequences. Enable loopback mode and check for `lane_up` assertions. Bring the `CHANNEL_INIT_SM` module FSM state signals to debug if `channel_up` is not asserted. For a simplex link, the simplex TX partner might have already achieved `channel_up` status. See the Channel Verification Procedure in the *Aurora 64B/66B Protocol Specification* (SP011) [Ref 9] for `channel_up` assertion details.

9. Periodic Channel Failures Check

If the Aurora 64B/66B core asserts and deasserts the `channel_up` signal, enable internal loopback and check for a stable channel up condition. Probe `RXBUFSTATUS` of the transceiver.

Multiple Lane:

8. Channel Bonding Assertion Check

Channel bonding is necessary for a multi-lane Aurora 64B/66B design. Channel bonding is performed by the transceiver and the required logic is present in the `transceiver_wrapper` module. Ensure that channel bonding level, master and slave connections are correct. See the channel bonding procedure in the *Aurora 64B/66B Protocol Specification* (SP011) [Ref 9] for `channel_up` assertion details.

9. CHANNEL\_UP Assertion Check

(See Single Lane, [step 8](#))

## 10. Periodic Channel Failures Check

(See Single Lane, [step 9](#))

## 11. Data Transfer Check

After `channel_up` is asserted, the Aurora 64B/66B core is ready to transfer data (wait for `trdy` assertion). Data errors can be monitored with VIO. The `tx_d` and `rx_d` signals are connected to monitor the data transfer. Also, `soft_err` and `hard_err` are connected to VIO. If `data_err_count` is incrementing, perform a loopback test as described in [step 12](#). If the loopback test passes, check the transmitted data and cable for channel integrity. Run the integrated bit error ratio test (IBERT) to confirm link connectivity and signal integrity (SI) on the channel. If IBERT runs are unsuccessful, monitor the power supplies and termination circuit, then run SI simulations on the transceiver.

## 12. LOOPBACK Testing Check

Loopback modes are specialized configurations of the transceiver datapath. The `loopback` port of the Aurora 64B/66B example design controls the loopback modes. Four loopback modes are available. [Figure C-2](#) illustrates a loopback test configuration with four different loopback modes. Refer to the respective transceiver user guide for guidelines and additional information.

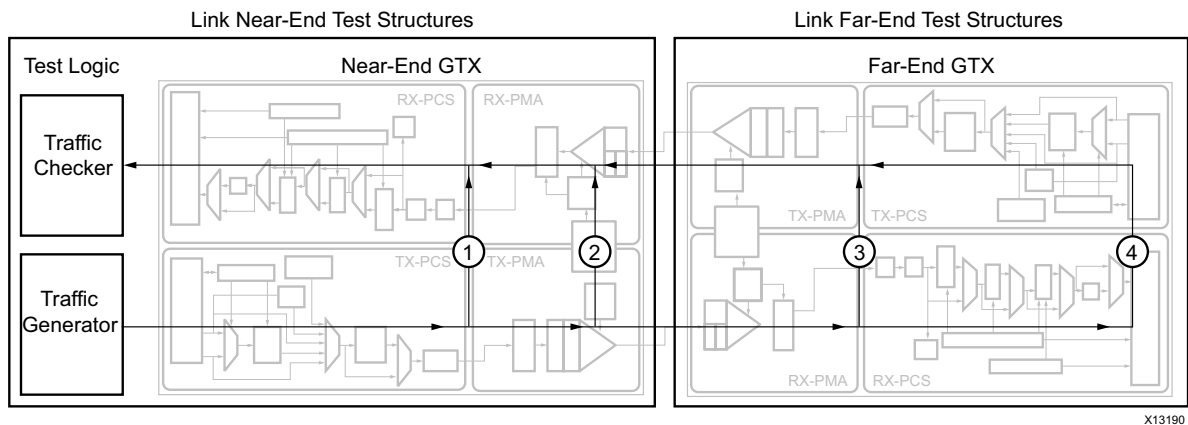

Figure C-2: Loopback Testing Overview

---

## Design Bring-Up on the KC705 Evaluation Board

For detailed procedures to set up and operate the Aurora 64B/66B core on the KC705 evaluation board, see *Designing a System Using the Aurora 64B66B Core (Duplex) on the KC705 Evaluation Kit Application Note (XAPP1192)* [Ref 15].

---

## Interface Debug

If data is not being transmitted or received for the AXI4-Stream Interfaces, check the following conditions:

- If transmit `s_axi_tx_tready` is stuck Low following the `s_axi_tx_tvalid` input being asserted, the core cannot send data.
- If the receive `s_axi_tx_tvalid` is stuck Low, the core is not receiving data.
- Check that the `user_clk` inputs are connected and toggling.
- Check that the AXI4-Stream waveforms are being followed. See [Figure 2-8, page 16](#).
- Check core configuration.

# Generating a GT Wrapper File from the Transceiver Wizard

The transceiver attributes play a vital role in the functionality of the Xilinx® LogiCORE™ IP Aurora 64B/66B core. Use the latest transceiver wizard to generate the transceiver wrapper file.



---

**RECOMMENDED:** Xilinx strongly recommends updating the transceiver wrapper file in the Vivado® Design Suite tool releases when the transceiver wizard has been updated but the Aurora 64B/66B core has not.

---

Use these steps to generate the transceiver wrapper file using the 7 series FPGAs Transceivers Wizard:

1. Using the Vivado IP Catalog, run the latest version of the 7 series FPGAs Transceivers Wizard. Ensure the Component Name of the transceiver wizard matches the Component Name of the Aurora 64B/66B core.
2. Select the protocol template: Aurora 64B/66B.
3. Set the Line Rate for both the TX and RX transceivers based on the application requirement.
4. Select the Reference Clock from the drop-down menu for both the TX and RX transceivers based on the application requirement.
5. Select transceiver(s) and the clock source(s) based on the application requirement.
6. On Page 3, select External Data Width of the RX transceiver to be 32 Bits and Internal Data Width to be 32 bits. Ensure that the TX transceiver is configured with 64-bit external data width and 32-bit internal data width.
7. Keep all other settings as default.
8. Generate the core.
9. Replace the `<user_component_name>_gtx.v` file in the `example_design/gt/` directory available in the Aurora 64B/66B core with the generated `<user_component_name>_gt.v` file generated from the 7 series FPGAs Transceivers Wizard.

The transceiver settings for the Aurora 64B/66B core are now up to date.

**Note:** The UltraScale™ architecture Aurora 64B/66B core uses the hierarchical core calling method to call the UltraScale device GTWizard IP core. In this way, all the transceiver attributes, parameters, and required workarounds are up to date. Manual editing of the UltraScale device transceiver files are not required in most cases.

# Additional Resources and Legal Notices

---

## Xilinx Resources

For support resources such as Answers, Documentation, Downloads, and Forums, see [Xilinx Support](#).

---

## References

These documents provide supplemental material useful with this product guide:

1. *Virtex UltraScale FPGAs Data Sheet: DC and AC Switching Characteristics* ([DS893](#))
2. *Kintex UltraScale FPGAs Data Sheet: DC and AC Switching Characteristics* ([DS892](#))
3. *7 Series FPGAs Overview* ([DS180](#))
4. *UltraScale Architecture and Product Overview* ([DS890](#))
5. *UltraScale Architecture GTH Transceivers User Guide* ([UG576](#))
6. *UltraScale Architecture GTY Transceivers User Guide* ([UG578](#))
7. *7 Series FPGAs GTX/GTH Transceivers User Guide* ([UG476](#))
8. *ARM AMBA 4 AXI4-Stream Protocol v1.0 Specification* ([ARM IHI 0051A](#))
9. *Aurora 64B/66B Protocol Specification* ([SP011](#))
10. *Vivado AXI Reference Guide* ([UG1037](#))
11. *Vivado Design Suite User Guide: Designing IP Subsystems using IP Integrator* ([UG994](#))
12. *Vivado Design Suite User Guide: Designing with IP* ([UG896](#))
13. *Vivado Design Suite User Guide: Getting Started* ([UG910](#))
14. *Vivado Design Suite User Guide - Logic Simulation* ([UG900](#))
15. *Designing a System Using the Aurora 64B66B Core (Duplex) on the KC705 Evaluation Kit Application Note* ([XAPP1192](#))
16. *UltraScale Architecture Migration Methodology Guide* ([UG1026](#))
17. *LogiCORE IP Aurora 64B/66B v4.2 Data Sheet* ([DS528](#))

18. LogiCORE IP Aurora 64B/66B v4.1 Getting Started Guide ([UG238](#))
19. LogiCORE IP Aurora 64B/66B v4.2 User Guide ([UG237](#))
20. ISE to Vivado Design Suite Migration Guide ([UG911](#))
21. Vivado Design Suite User Guide: Programming and Debugging ([UG908](#))
22. UltraScale FPGAs Transceivers Wizard Product Guide ([PG182](#))
23. Virtex-7 FPGAs Data Sheet: DC and Switching Characteristics ([DS183](#))
24. Kintex-7 FPGAs Data Sheet: DC and Switching Characteristics ([DS182](#))
25. Synthesis and Simulation Design Guide ([UG626](#))
26. Packaging Custom AXI IP for Vivado IP Integrator Application Note ([XAPP1168](#))
27. LogiCORE IP Aurora 64B/66B v7.3 Product Guide ([PG074](#))
28. UltraScale FPGAs Transceivers Wizard LogiCORE IP Product Guide ([PG182](#))

---

## Revision History

The following table shows the revision history for this document

Date	Version	Revision
10/05/2016	11.1	<ul style="list-style-type: none"> <li>• Removed the Example design directory structure due to the updates in Vivado flows for 2016.3.</li> </ul>
06/08/2016	11.1	<ul style="list-style-type: none"> <li>• Added Reference to <code>GT_Debug_Flowchart</code> in AR 57237</li> <li>• Updated <code>C_EXAMPLE_SIMULATION</code> usage description</li> <li>• Updated Unsupported features</li> <li>• Updated references to UG578</li> </ul>
04/06/2016	11.1	Added Managed Shared Logic Files section under Output Generation in Chapter 4: Design Flow Steps.
11/18/2015	11.0	Added support for UltraScale+ families.
12/14/2015	11.0	Added UltraScale+™ families to the IP Facts table
09/30/2015	11.0	<ul style="list-style-type: none"> <li>• Updated first paragraph in Port Descriptions section.</li> <li>• Added <code>bufg_gt_clr_out</code> and a note to Table 2-6.</li> <li>• Added a note (19) to Table 2-11.</li> <li>• Added GTY transceiver support.</li> <li>• Updated graphics in Chapter 4, Design Flow Steps.</li> </ul>

Date	Version	Revision
04/01/2015	10.0	<p><b>General changes</b></p> <ul style="list-style-type: none"> <li>• Updated Max line rate information.</li> <li>• Updated information for GT location selection option for Ultrascale devices</li> <li>• Grouped Flow control AXI ports into AXI4 Stream interface.</li> <li>• Added as a single row entry the interface to which a port belongs.</li> <li>• Updated single ended clock option information.</li> <li>• Added support for the Simplex Auto Link Recovery feature</li> <li>• Updated Reset section.</li> <li>• Moved all of the material in the Core Features chapter to the end of Chapter 3, Designing with the Core. Deleted Chapter 4.</li> <li>• Added Single/Differential clocking option for GTREFCLK and core INIT_CLK</li> <li>• Removed data strobe information.</li> <li>• Removed do_cc information.</li> </ul>
04/01/2015 (continued)	10.0	<p><b>Chapter 2, Product Specification</b></p> <ul style="list-style-type: none"> <li>• Updated TX user interface description</li> <li>• Updated Figure 2-4, Figure 2-12, Figure 22-14.</li> <li>• Added reset2fg, reset2fc, gt_pcsrsvdin, gt&lt;lane&gt;_txinhibit_in/gt_txinhibit to Table 2-13: Transceiver Control and Status Interface Ports table.</li> <li>• Added the CORE_STATUS, GT_SERIAL_RX, GT_SERIAL_TX, CORE_CONTROL, QPLL_CONTROL_OUT, and QPLL_CONTROL_IN headings to Table 2-13.</li> <li>• Removed reset/tx_reset/rx_reset from Table 2-14.</li> <li>• Added Checking CRC at Core Level subsection to CRC Interface section.</li> </ul>
		<p><b>Chapter 3, Designing with the Core</b></p> <ul style="list-style-type: none"> <li>• Moved all of the material from the Core Features chapter to this chapter. Removed the Core Features chapter.</li> <li>• Added a note to Figure 3-1. Updated Figure 3-2, Figure, 3-3, Figure 3-6, Figure 3-17.</li> <li>• Revised the following sections: Reset Sequencing, Aurora 64B/66B Simplex Power On Sequence, Aurora 64B/66B Simplex Normal Operation Reset Sequence, Aurora 64B/66B Simplex TX and RX, and Reset Flow.</li> <li>• Added a Single Ended option note to the Shared Logic section.</li> <li>• Revised Clock Compensation section and moved to this chapter.</li> <li>• Updated Figure 3-6, Figure 4-3, Figure 5-1, Figure B-3.</li> </ul>



Date	Version	Revision
		<p><b>Chapter 4, Design Flow Steps</b> (previously, Chapter 5)</p> <ul style="list-style-type: none"> <li>• Updated all screen captures.</li> <li>• Added four options to the Core Options tab: Lanes, Starting GT Quad, Starting GT Lane, and GT Refclk Selection.</li> <li>• Added two parameters to Table 4-1: Single Ended INIT CLK and Single Ended GTREF CLK</li> <li>• Removed Transceiver Channel Locations section.</li> <li>• Deleted Figure 4-4.</li> <li>• Replaced code in Example Design section.</li> <li>• Added six rows to User Parameters table: Column Used, Starting GT Quad, Starting GT Lane, GT Refclk Selection, Single Ended INIT CLK, and Single Ended GTREF CLK.</li> <li>• Added notes 11 and 12 to Table 4-1.</li> <li>• Removed Transceiver Channel Locations section.</li> <li>• Deleted Figure 4-4 and the text following the figure.</li> </ul> <p><b>Appendix A: Verification, Compliance, and Interoperability</b></p> <ul style="list-style-type: none"> <li>• Added Table A-3: 2015.1 Aurora 64B/66B Interoperability.</li> <li>• Updated the release numbers in the bulleted items under BACKWARD_COMP_MODE1 /BACKWARD_COMP_MODE2 and BACKWARD_COMP_MODE3</li> </ul> <p><b>Appendix B: Migrating and Upgrading</b></p> <ul style="list-style-type: none"> <li>• Removed existing rows from Table B-1 and added six new rows.</li> <li>• Modified Overview of Major Changes section.</li> <li>• Updated Figure B-3.</li> </ul> <p><b>Appendix C: Debugging</b></p> <p>Changed "Vivado lab tools" to "Vivado Lab Edition."</p>
10/01/2014	9.3	<ul style="list-style-type: none"> <li>• Added new v9.3 core features and attributes</li> <li>• Rearranged content to consolidate topics and better conform to template</li> </ul>
06/04/2014	9.2	<ul style="list-style-type: none"> <li>• Added User Parameter information.</li> </ul>
04/02/2014	9.2	<ul style="list-style-type: none"> <li>• Added C_EXAMPLE_SIMULATION parameter for post synthesis/implementation simulation speedup.</li> <li>• Added support for UltraScale™ devices.</li> <li>• Enhanced support for IP integrator.</li> <li>• Added Little endian support for data and flow control interfaces as non-default Vivado® IDE selectable option.</li> <li>• Provided interoperability guidance.</li> <li>• Resolved functional issue seen with specific frame lengths in certain scenarios.</li> </ul>
12/18/2013	9.1	<ul style="list-style-type: none"> <li>• Added default information to init_clk_p, initclk_n, and INIT_CLK description.</li> <li>• Updated reset sequencing steps and waveform.</li> <li>• Added information about pma_init staging.</li> <li>• Updated screen captures.</li> <li>• Added sequence of steps describing hardware FSM reset</li> </ul>

Date	Version	Revision
10/02/2013	9.0	<ul style="list-style-type: none"> <li>• Added new chapters: Simulation, Test Bench and Synthesis and Implementation.</li> <li>• Added shared logic and transceiver debug features.</li> <li>• Updated directory and file structure.</li> <li>• Changed signal and port names to lowercase.</li> <li>• Added Zynq®-7000 device support.</li> <li>• Updated RX datapath architecture.</li> <li>• Updated Aurora Simplex Operation description.</li> <li>• Updated Figure 3-2 and screen captures in Chapter 4.</li> <li>• Updated Hot-Plug Logic description.</li> <li>• Added IP integrator support.</li> <li>• Updated XDC file for the example design.</li> <li>• Added design bring-up on evaluation board information.</li> </ul>
06/19/2013	8.1	<ul style="list-style-type: none"> <li>• Revision number advanced to 8.1 to align with core version number.</li> <li>• Updated for 2013.2 release and core version 8.1.</li> <li>• Fixed a NFC transmit failure scenario when Clock Correction is transmitted in conjunction with the second NFC request. NFC state machine is updated to handle such scenarios.</li> </ul>
03/20/2013	2.0	<ul style="list-style-type: none"> <li>• Updated for 2013.1 release and core version 8.0.</li> <li>• Removed all ISE® design tools and Virtex®-6 related device information.</li> <li>• Added Reset waveforms</li> <li>• Updated debug guide with core and transceiver debug details</li> <li>• Created lowercase ports for Verilog</li> <li>• Added Simplex TX/RX support</li> <li>• Enhanced protocol to increase Channel Init time</li> <li>• Included TXSTARTUPFSM and RXSTARTUPFSM modules to control GT reset sequence</li> </ul>
12/18/2012	1.0.1	<ul style="list-style-type: none"> <li>• Updated for 14.4 and 2012.4 release.</li> <li>• Added TKEEP description</li> <li>• Updated Debugging appendix.</li> </ul>
10/16/2012	1.0	<p>Initial Xilinx release as a product guide. This document replaces UG775, <i>LogiCORE IP Aurora 64B/66B User Guide</i> and DS815, <i>LogiCORE IP Aurora 64B/66B Data Sheet</i>.</p> <ul style="list-style-type: none"> <li>• Added section explaining constraining of the core.</li> <li>• Added section explaining core debugging.</li> </ul>

## Please Read: Important Legal Notices

The information disclosed to you hereunder (the "Materials") is provided solely for the selection and use of Xilinx products. To the maximum extent permitted by applicable law: (1) Materials are made available "AS IS" and with all faults, Xilinx hereby DISCLAIMS ALL WARRANTIES AND CONDITIONS, EXPRESS, IMPLIED, OR STATUTORY, INCLUDING BUT NOT LIMITED TO WARRANTIES OF MERCHANTABILITY, NON-INFRINGEMENT, OR FITNESS FOR ANY PARTICULAR PURPOSE; and (2) Xilinx shall not be liable (whether in contract or tort, including negligence, or under any other theory of liability) for any loss or damage of any kind or nature related to, arising under, or in connection with, the Materials (including your use of the Materials), including for any direct, indirect, special, incidental, or consequential loss or damage (including loss of data, profits, goodwill, or any type of loss or damage suffered as a result of any action brought by a third party) even if such damage or loss was reasonably foreseeable or Xilinx had been advised of the possibility of the same. Xilinx assumes no obligation to correct any errors contained in the Materials or to notify you of updates to the Materials or to product specifications. You may not reproduce, modify, distribute, or publicly display the Materials without prior written consent. Certain products are subject to the terms and conditions of Xilinx's limited warranty, please refer to Xilinx's Terms of Sale which can be viewed at <http://www.xilinx.com/legal.htm#tos>; IP cores may be subject to warranty and support terms contained in a license issued to you by Xilinx. Xilinx products are not designed or intended to be fail-safe or for use in any application requiring fail-safe performance; you assume sole risk and liability for use of Xilinx products in such critical applications, please refer to Xilinx's Terms of Sale which can be viewed at <http://www.xilinx.com/legal.htm#tos>.

### **AUTOMOTIVE APPLICATIONS DISCLAIMER**

AUTOMOTIVE PRODUCTS (IDENTIFIED AS "XA" IN THE PART NUMBER) ARE NOT WARRANTED FOR USE IN THE DEPLOYMENT OF AIRBAGS OR FOR USE IN APPLICATIONS THAT AFFECT CONTROL OF A VEHICLE ("SAFETY APPLICATION") UNLESS THERE IS A SAFETY CONCEPT OR REDUNDANCY FEATURE CONSISTENT WITH THE ISO 26262 AUTOMOTIVE SAFETY STANDARD ("SAFETY DESIGN"). CUSTOMER SHALL, PRIOR TO USING OR DISTRIBUTING ANY SYSTEMS THAT INCORPORATE PRODUCTS, THOROUGHLY TEST SUCH SYSTEMS FOR SAFETY PURPOSES. USE OF PRODUCTS IN A SAFETY APPLICATION WITHOUT A SAFETY DESIGN IS FULLY AT THE RISK OF CUSTOMER, SUBJECT ONLY TO APPLICABLE LAWS AND REGULATIONS GOVERNING LIMITATIONS ON PRODUCT LIABILITY.

© Copyright 2012–2016 Xilinx, Inc. Xilinx, the Xilinx logo, Artix, ISE, Kintex, Spartan, Virtex, Vivado, Zynq, and other designated brands included herein are trademarks of Xilinx in the United States and other countries. AMBA, AMBA Designer, ARM, ARM1176JZ-S, CoreSight, Cortex, and PrimeCell are trademarks of ARM in the EU and other countries. All other trademarks are the property of their respective owners.