

# Vivado Design Suite Tutorial

## *Programming and Debugging*

UG936 (v2021.2) November 10, 2021

Xilinx is creating an environment where employees, customers, and partners feel welcome and included. To that end, we're removing non-inclusive language from our products and related collateral. We've launched an internal initiative to remove language that could exclude people or reinforce historical biases, including terms embedded in our software and IPs. You may still find examples of non-inclusive language in our older products as we work to make these changes and align with evolving industry standards. Follow this [link](#) for more information.



# Revision History

The following table shows the revision history for this document.

Section	Revision Summary
<b>11/10/2021 Version 2021.2</b>	
<a href="#">Design Files</a>	Updated design files.
<b>07/14/2021 Version 2021.1</b>	
General updates	N/A

# Table of Contents

<b>Revision History</b> .....	<b>2</b>
<b>Debugging in Vivado Tutorial</b> .....	<b>6</b>
Navigating Content by Design Process.....	6
Objectives.....	7
Getting Started.....	8
<b>Lab 1: Using the Netlist Insertion Method to Debug a Design</b> .....	<b>13</b>
Step 1: Creating a Project with the Vivado New Project Wizard.....	13
Step 2: Synthesizing the Design.....	14
Step 3: Probing and Adding Debug IP.....	15
Step 4: Implementing and Generating Bitstream.....	23
<b>Lab 2: Using the HDL Instantiation Method to Debug a Design</b> .....	<b>24</b>
Step 1: Creating a Project with the Vivado New Project Wizard.....	24
Step 2: Synthesize Implement and Generate Bitstream.....	26
<b>Lab 3: Using a VIO Core to Debug a Design in Vivado Design Suite</b> .....	<b>27</b>
Step 1: Creating a Project with the Vivado New Project Wizard.....	28
Step 2: Synthesize, Implement, and Generate the Bitstream.....	32
<b>Lab 4: Using the Synplify Pro Synthesis Tool and Vivado Design Suite to Debug a Design</b> .....	<b>34</b>
Step 1: Create a Synplify Pro Project.....	34
Step 2: Synthesize the Synplify Project.....	40
Step 3: Create DCPs for the Black Box Created in Synplify Pro.....	41
Step 4: Create a Post Synthesis Project in Vivado IDE.....	41
Step 5: Add More Debug Nets to the Project.....	42
Step 6: Implementing the Design and Generating the Bitstream.....	45
<b>Lab 5: Using the Vivado Logic Analyzer to Debug Hardware</b> .....	<b>46</b>
Step 1: Verifying Operation of the Sine Wave Generator.....	46

Step 2: Debugging the Sine Wave Sequencer State Machine (Optional).....	57
<b>Lab 6: Using the ECO Flow to Replace Debug Probes Post Implementation.....</b>	<b>75</b>
<b>Lab 7: Debugging Designs Using the Incremental Compile Flow.....</b>	<b>88</b>
Procedure.....	88
Step 1: Opening the Example Design and Adding a Debug Core.....	88
Step 2: Compiling the Reference Design.....	92
Step 3: Create New Runs.....	93
Step 4: Making Incremental Debug Changes.....	95
Step 5: Running Incremental Compile.....	98
Conclusion.....	100
<b>Lab 8: Using the Vivado Serial Analyzer to Debug Serial Links.....</b>	<b>101</b>
Design Description.....	101
Step 1: Creating, Customizing, and Generating an IBERT Design.....	102
Step 2: Adding an IBERT Core to the Vivado Project.....	103
Step 3: Synthesize, Implement and Generate Bitstream for the IBERT Design.....	109
Step 4: Interact with the IBERT Core Using Serial I/O Analyzer.....	111
<b>Lab 9: Using the Vivado ILA Core to Debug JTAG-AXI Transactions.....</b>	<b>127</b>
Design Description.....	127
Step 1: Creating a New Vivado Project and Generating the IP Integrator Design with JTAG-to-AXI and System ILA.....	128
Step 2: Program the KC705 Board and Interact with the JTAG to AXI Master Core.....	141
Step 3: Using ILA Advanced Trigger Feature to Trigger on an AXI Read Transaction....	147
<b>Lab 10: Using the Vivado Serial Analyzer to Debug PS-GTR Serial Links.....</b>	<b>151</b>
IBERT PS-GTR Flow.....	151
Step 1: Generating a Zynq UltraScale+ MPSoC PS Xilinx Support Archive.....	153
Step 2: Using Xilinx Software Command-line Tool Flow to Generate a First Stage Boot Loader.....	163
Step 3: ZCU102 Board Settings.....	164
Using FSBL with Serial I/O Analyzer to Bring Up IBERT PS-GTR.....	165
Troubleshooting.....	172

<b>Appendix A: Additional Resources and Legal Notices.....</b>	<b>174</b>
Xilinx Resources.....	174
Documentation Navigator and Design Hubs.....	174
Please Read: Important Legal Notices.....	175

# Debugging in Vivado Tutorial

This document contains a set of tutorials designed to help you debug complex FPGA designs. The first four labs explain different kinds of debug flows that you can choose to use during the course of debug. These labs introduce the Vivado® Design Suite debug methodology recommended to debug your FPGA designs. The labs describe the steps involved in taking a small RTL design and the multiple ways of inserting the Integrated Logic Analyzer (ILA) core to help debug the design. The fifth lab is for debugging high-speed serial I/O links in the Vivado tool. The sixth lab is for debugging JTAG-AXI transactions in the Vivado tool. The first four labs converge at the same point when connected to a target hardware board.

Example RTL designs are used to illustrate overall integration flows between the Vivado logic analyzer, ILA, and the Vivado Integrated Design Environment (IDE). To be successful using this tutorial, you should have some basic knowledge of the Vivado tool flow.



**TRAINING:** Xilinx provides training courses that can help you learn more about the concepts presented in this document. Use these links to explore related courses:

- [Designing FPGAs Using the Vivado Design Suite 1](#)
- [Designing FPGAs Using the Vivado Design Suite 2](#)
- [Designing FPGAs Using the Vivado Design Suite 3](#)
- [Designing FPGAs Using the Vivado Design Suite 4](#)
- [Vivado Design Suite User Guide: Programming and Debugging \(UG908\)](#)

---

## Navigating Content by Design Process

Xilinx® documentation is organized around a set of standard design processes to help you find relevant content for your current development task. All Versal® ACAP design process [Design Hubs](#) and the [Design Flow Assistant](#) materials can be found on the [Xilinx.com](#) website. This document covers the following design processes:

- **Hardware, IP, and Platform Development:** Creating the PL IP blocks for the hardware platform, creating PL kernels, functional simulation, and evaluating the Vivado® timing, resource use, and power closure. Also involves developing the hardware platform for system integration. Topics in this document that apply to this design process include:
  - [Lab 1: Using the Netlist Insertion Method to Debug a Design](#)
  - [Lab 2: Using the HDL Instantiation Method to Debug a Design](#)
  - [Lab 3: Using a VIO Core to Debug a Design in Vivado Design Suite](#)

- [Lab 4: Using the Synplify Pro Synthesis Tool and Vivado Design Suite to Debug a Design](#)
- [Lab 5: Using the Vivado Logic Analyzer to Debug Hardware](#)
- [Lab 6: Using the ECO Flow to Replace Debug Probes Post Implementation](#)
- [Lab 7: Debugging Designs Using the Incremental Compile Flow](#)
- [Lab 9: Using the Vivado ILA Core to Debug JTAG-AXI Transactions](#)
- **Board System Design:** Designing a PCB through schematics and board layout. Also involves power, thermal, and signal integrity considerations. Topics in this document that apply to this design process include:
  - [Lab 6: Using the ECO Flow to Replace Debug Probes Post Implementation](#)
  - [Lab 7: Debugging Designs Using the Incremental Compile Flow](#)
  - [Lab 8: Using the Vivado Serial Analyzer to Debug Serial Links](#)
  - [Lab 10: Using the Vivado Serial Analyzer to Debug PS-GTR Serial Links](#)

## Objectives

These tutorials:

- Show you how to take advantage of integrated Vivado® logic analyzer features in the Vivado design environment that make the debug process faster and simpler.
- Provide specifics on how to use the Vivado IDE and the Vivado logic analyzer to debug common problems in FPGA logic designs.
- Provide specifics on how to use the Vivado Serial I/O Analyzer to debug high-speed serial links.

After completing this tutorial, you will be able to:

- Validate and debug your design using the Vivado Integrated Design Environment (IDE) and the Integrated Logic Analyzer (ILA) core.
- Understand how to create an RTL project, probe your design, insert an ILA core, and implement the design in the Vivado IDE.
- Generate and customize an IP core netlist in the Vivado IDE.
- Debug the design using Vivado logic analyzer in real-time, and iterate the design using the Vivado IDE and a KC705 Evaluation Kit Base Board that incorporates a Kintex®-7 device.
- Analyze high-speed serial links using the Serial I/O Analyzer.

# Getting Started

## Setup Requirements

Before you start this tutorial, make sure you have and understand the hardware and software components needed to perform the labs included in this tutorial.

### Software

Vivado® Design Suite 2021.1.

### Hardware

- Kintex®-7 FPGA KC705 Evaluation Kit Base Board
- Digilent Cable
- Two SMA (Sub-miniature version A) cables

*Figure 1: KC705 Board Showing Key Components*

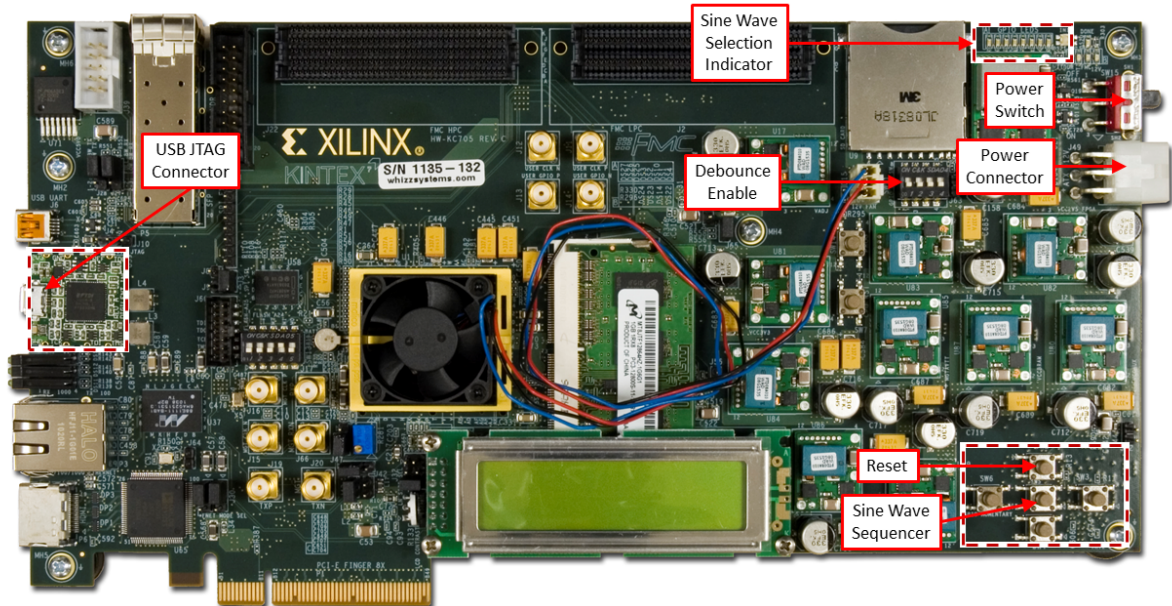

## Tutorial Design Components

Labs 1 through 4 include:



- A simple control state machine
- Three sine wave generators using AXI4-Stream interface, native DDS Compiler
- Common push buttons (GPIO\_BUTTON)
- DIP switches (GPIO\_SWITCH)
- LED displays (GPIO\_LED) VIO Core (Lab 3 only)
- **Pushbutton Switches:** Serve as inputs to the de-bounce and control state machine circuits. Pushing a button generates a high-to-low transition pulse. Each generated output pulse is used as an input into the state machine.
- **DIP Switch:** Enables or disables a de-bounce circuit.
- **De-bounce Circuit:** This example, when enabled, provides a clean pulse or transition from high to low. Eliminates a series of spikes or glitches when a button is pressed and released.
- **Sine Wave Sequencer State Machine:** Captures and decodes input from the two push buttons. Provides sine wave selection and indicator circuits, sequencing among 00, 01, 10, and 11 (zero to three).
- **LED Displays:** GPIO\_LED\_0 and GPIO\_LED\_1 display selection status from the state machine outputs, each of which represents a different sine wave frequency: high, medium, and low.

Lab 5 includes:

- An IBERT core
- A top-level wrapper that instantiates the IBERT core

## Board Support and Pinout Information

*Table 1: Pinout Information for the KC705 Board*

Pin Name	Pin Location	Description
CLK_N	AD11	Clock
CLK_P	AD12	Clock
GPIO_BUTTONS[0]	AA12	Reset
GPIO_BUTTONS[1]	AG5	Sine Wave Sequencer
GPIO_SWITCH	Y28	De-bounce Circuit Selector
LEDS_n[0]	AB8	Sine Wave Selection[0]
LEDS_n[1]	AA8	Sine Wave Selection[1]
LEDS_n[2]	AC9	Reserved
LEDS_n[3]	AB9	Reserved

## Design Files

1. In your C: drive, create a folder called `/Vivado_Debug`.
2. Download the [Reference Design Files](#) from the Xilinx website.



---

**CAUTION!** *The tutorial and design files may be updated or modified between software releases. You can download the latest version of the material from the Xilinx website.*

---

3. Unzip the tutorial source file to the `/Vivado_Debug` folder. There are six labs that use different methodologies for debugging your design. Select the appropriate lab and follow the steps to complete them.
  - **Lab 1:** This lab walks you through the steps of marking nets for debug in HDL as well as the post-synthesis netlist (netlist insertion method). Following are the required files:
    - `debounce.vhd`
    - `fsm.vhd`
    - `sinegen.vhd`
    - `sinegen_demo.vhd`
    - `sine_high/sine_high.xci`
    - `sine_low/sine_low.xci`
    - `sine_mid/sine_mid.xci`
    - `sinegen_demo_kc705.xdc`
  - **Lab 2:** This lab goes over the details of marking nets for debug in the source HDL (HDL instantiation method) as well as instantiating an ILA core in the HDL. Following are the required files:
    - `debounce.vhd`
    - `fsm.vhd`
    - `sinegen.vhd`
    - `sinegen_demo_inst.vhd`
    - `ila_0/ila_0.xci`
    - `sine_high/sine_high.xci`
    - `sine_low/sine_low.xci`
    - `sine_mid/sine_mid.xci`
    - `sinegen_demo_kc705.xdc`

- **Lab 3:** You can test your design even if the hardware is not physically accessible, using a VIO core. This lab walks you through the steps of instantiating and customizing a VIO core that you will hook to the I/Os of the design. Following are the required files:
  - `debounce.vhd`
  - `fsm.vhd`
  - `sinegen.vhd`
  - `sinegen_demo_inst_vio.vhd`
  - `sine_high/sine_high.xci`
  - `sine_low/sine_low.xci`
  - `sine_mid/sine_mid.xci`
  - `ila_0/ila_0.xci`
  - `sinegen_demo_kc705.xdc`
- **Lab 4:** Nets can also be marked for debug in a third-party synthesis tool using directives for the synthesis tool. This lab walks you through the steps of marking nets for debug in the Synplify tool and then using Vivado® to perform the rest of the debug. Following are the required files:
  - `debounce.vhd`
  - `fsm.vhd`
  - `sign_high.dcp`
  - `sign_low.dcp`
  - `sine_mid.dcp`
  - `sine_high.xci`
  - `sine_low.xci`
  - `sine_mid.xci`
  - `sinegen.edn`
  - `sinegen_synplify.vhd`
  - `synplify_1.sdc`
  - `synplify_1.fdc`
  - `sinegen_demo_kc705.xdc`
- **Lab 5:** Take designs created from Lab 1, Lab 2, Lab 3, and Lab 4 and load them onto the KC705 board.
- **Lab 6:** Enhance post implementation debugging by using the ECO flow to replace debug probes.

- **Lab 7:** Use the Incremental Compile flow to enable faster debugging flows. Using the results from a previous implementation run, this flow allows you to make debug modifications and rerun implementation.
- **Lab 8:** Debug high-speed serial I/O links using the Vivado Serial I/O Analyzer. This lab uses the Vivado IP example design.
- **Lab 9:** Use Vivado ILA core to debug JTAG-to-AXI transactions. This lab uses the Vivado IP example design.
- **Lab 10:** Use the IBERT UltraScale+ PS-GTR transceiver to evaluate and monitor PS-GTR transceivers in Zynq® UltraScale+™ MPSoC devices. This lab is purely software-based, setting up and testing the processing system (PS) side of the Zynq UltraScale+ MPSoC device with no programmable logic (PL).

## Connecting the Boards and Cables

1. Connect the Digilent cable from the Digilent cable connector to a USB port on your computer.
2. Connect the two SMA cables (for lab 5 only) as follows:
  - a. Connect one SMA cable from J19 (TXP) to J17 (RXP).
  - b. Connect the other SMA cable from J20 (TXN) to J66 (RXN).

The relative locations of SMA cables on the board are shown in [Setup Requirements](#).

# Using the Netlist Insertion Method to Debug a Design

In this lab, you will mark signals for debug in the source HDL as well as the post synthesis netlist. Then you will create an Integrated Logic Analyzer (ILA) core and take the design through implementation. Finally, you will use the Vivado® tool to connect to the KC705 target board and debug your design with the Vivado Integrated Logic Analyzer.

---

## Step 1: Creating a Project with the Vivado New Project Wizard

To create a project, use the New Project wizard to name the project, to add RTL source files and constraints, and to specify the target device.

1. Invoke the Vivado IDE.
2. In the Getting Started page, click **Create Project** to start the New Project wizard. Click **Next**.
3. In the Project Name page, name the new project `proj_netlist` and provide the project location (`C:/Vivado_Debug`). Ensure that **Create Project Subdirectory** is selected and click **Next**.
4. In the Project Type page, specify the type of project to create as RTL Project. Click **Next**.
5. In the Add Sources page:
  - a. Set Target Language to **VHDL**.
  - b. Click the “+” sign, and then click **Add Files**.
  - c. In the Add Source Files dialog box, navigate to the `/src/lab1` directory.
  - d. Select all VHD source files, and click **OK**.
  - e. Verify that the files are added, and **Copy Sources into project** is selected.
6. Click **Add**.
7. In the Add Directories dialog box, navigate to the `/src/lab1` directory.
8. Select `sine_high`, `sine_low`, and `sine_mid` directories and click **Select**.
9. Verify that the directories are added. Click **Next**.

10. In the Add Constraints dialog box, click the “+” sign, and then click **Add Files**.
  11. Navigate to `/src/lab1` directory and select `sinegen_demo_kc705.xdc`. Click **Next**.
  12. In the Default Part dialog box, specify the **xc7k325tffg900-2** part for the KC705 platform. You can also select **Boards** and then select **Kintex-7 KC705 Evaluation Platform**. Click **Next**.
  13. Review the New Project Summary page. Verify that the data appears as expected, per the steps above, and click **Finish**.
- Note:** It could take a moment for the project to initialize.

## Step 2: Synthesizing the Design

1. In the Project Manager, click **Settings** as shown in the following figure.

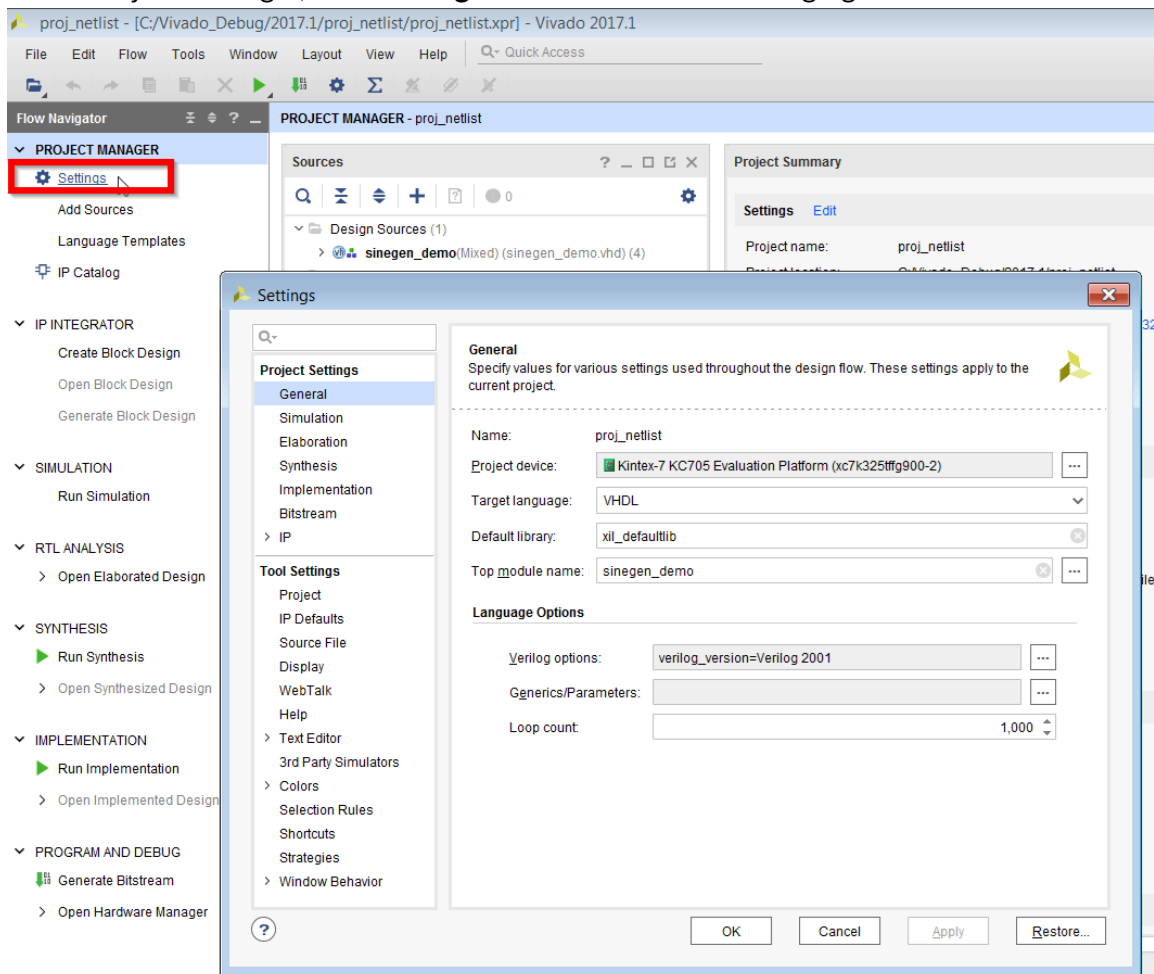

**IMPORTANT!** As an optional step, in the Settings dialog box, select **Synthesis** from the left and change **flatten hierarchy** to **none**. The reason for changing this setting to none is to prevent the synthesis tool from performing any boundary optimizations for this tutorial.

- In the Vivado® Flow Navigator, expand the Synthesis drop-down list, and click **Run Synthesis**. In the Launch Runs dialog box, accept all of the default settings (Launch runs on local host), and click **OK**.

**Note:** When synthesis runs, a progress indicator appears, showing that synthesis is occurring. This could take a few minutes.

- In the Synthesis Completed dialog box, click **Cancel** as shown in the following figure. You will implement the design later.

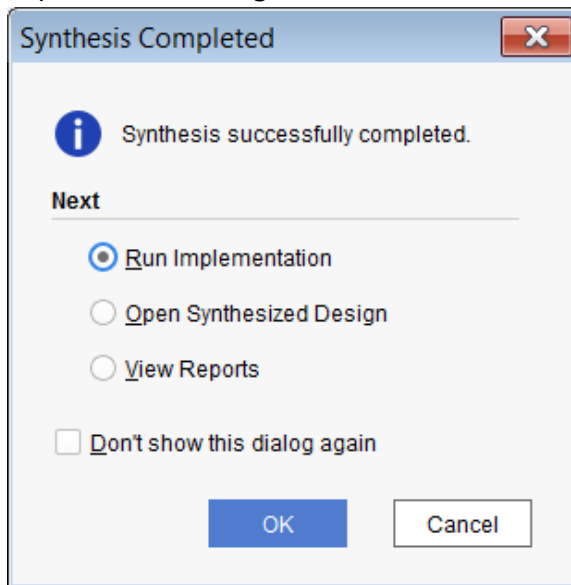

---

## Step 3: Probing and Adding Debug IP

To add a Vivado ILA core to the design, take advantage of the integrated flows between the Vivado IDE and Vivado logic analyzer.

In this step, you will accomplish the following tasks:

- Add debug nets to the project.
- Run the Set Up Debug wizard.
- Implement and open the design.
- Generate the bitstream.

### Adding Debug Nets to the Project

Following are some ways to add debug nets using the Vivado IDE:

- Add MARK\_DEBUG attribute to HDL files.
  - **VHDL:**

```
attribute mark_debug : string;
attribute mark_debug of sine      : signal is "true";
attribute mark_debug of sineSel   : signal is "true";
```

- **Verilog:**

```
(* mark_debug = "true" *) wire sine;
(* mark_debug = "true" *) wire sineSel;
```

This method lets you probe signals at the HDL design level. This can prevent optimization that might otherwise occur to that signal. It also lets you pick up the signal tagged for post synthesis, so you can insert these signals into a debug core and observe the values on this signal during FPGA operation. This method gives you the highest probability of preserving HDL signal names after synthesis.

- Right-click and select **Mark Debug** or **Unmark Debug** on a synthesized netlist.

This method is flexible because it allows probing the synthesized netlist in the Vivado IDE and allows you to add/remove MARK\_DEBUG attributes at any hierarchy in the design. In addition, this method does not require HDL source modification. However, there can be situations where synthesis might not preserve the signals due to netlist optimization involving absorption or merging of design structures.

- Use a Tcl prompt to set the MARK\_DEBUG attribute on a synthesized netlist.

```
set_property mark_debug true [get_nets -hier [list {sine[*]}]]
```

This applies the MARK\_DEBUG on the current, open netlist.

This method is flexible because you can turn MARK\_DEBUG on and off by modifying the Tcl command. In addition, this method does not require HDL source modification. However, there might be situations where synthesis does not preserve the signals due to netlist optimization involving absorption or merging of design structures.

In the following steps, you learn how to add debug nets to HDL files and the synthesized design using Vivado IDE.



**TIP:** Before proceeding, make sure that the Flow Navigator on the left panel is enabled.

Use Ctrl-Q to toggle it off and on.

1. In the Flow Navigator under the Synthesis drop-down list, click **Open Synthesized Design** as shown in the following figure.

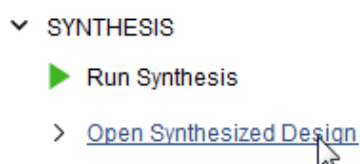



- In the Window drop-down menu, select **Debug**. When the Debug window opens, click the window if it is not already selected.
- Expand the Unassigned Debug Nets folder. The following figure shows those debug nets that were tagged with MARK\_DEBUG attributes in `sinegen_demo.vhd`.

```

62  -- Add mark_debug attributes to show debug nets in the synthesized netlist
63  attribute mark_debug : string;
64  attribute mark_debug of GPIO_BUTTONS_db : signal is "true";
65  attribute mark_debug of GPIO_BUTTONS_dly : signal is "true";
66  attribute mark_debug of GPIO_BUTTONS_re : signal is "true";
67  attribute mark_debug of DONT_EAT : signal is "true";
68
69
70  component sinegen
71  port
72  (
73     clk   : in   std_logic;
74     reset : in   std_logic;
75     sel   : in   std_logic_vector(1 downto 0);
76     sine  : out  std_logic_vector(19 downto 0)
77  );
78
79  end component;

```

Name	Driver Cell	Driver Pin
Unassigned Debug Nets (7)		
GPIO_BUTTONS_db (2)	FDRE	Q
GPIO_BUTTONS_db[0]	FDRE	Q
GPIO_BUTTONS_db[1]	FDRE	Q
GPIO_BUTTONS_dly (2)	FDRE	Q
GPIO_BUTTONS_dly[0]	FDRE	Q
GPIO_BUTTONS_dly[1]	FDRE	Q
GPIO_BUTTONS_re (2)	FDRE	Q
GPIO_BUTTONS_re[0]	FDRE	Q
GPIO_BUTTONS_re[1]	FDRE	Q
DONT_EAT	FDRE	Q

- In the Netlist window, select the Netlist tab and expand Nets. Select the following nets for debugging as shown in the following figure.
  - GPIO\_BUTTONS\_IBUF[0] and GPIO\_BUTTONS\_IBUF[1]**: Nets folder under the top-level hierarchy
  - sel(2)**: Nets folder under the U\_SINEGEN hierarchy

- **sine(20)**: Nets folder under the U\_SINEGEN hierarchy

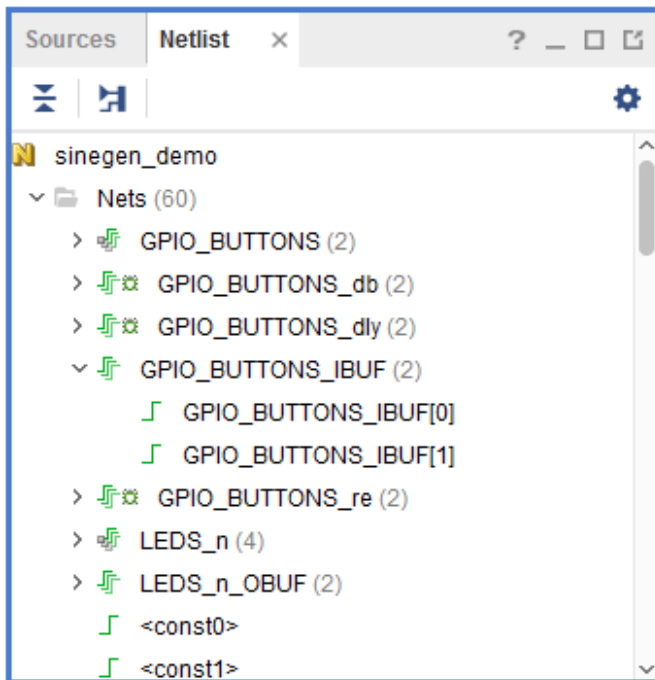

**Note:** These signals represent the significant behavior of this design and are used to verify and debug the design in subsequent steps.

5. Right-click the selected nets and select **Mark Debug** as shown in the following figure.

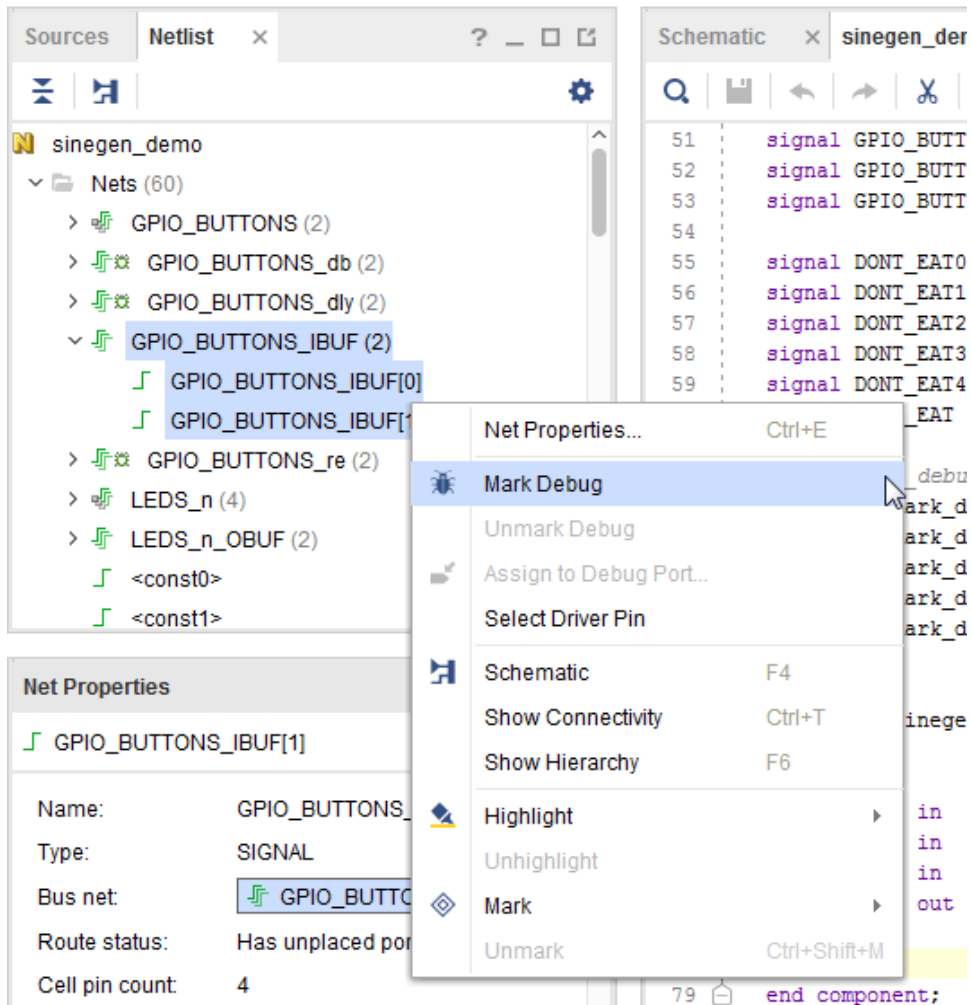

- Next, mark nets for debug in the Tcl Console. Mark nets “sine(20)” under the U\_SINEGEN hierarchy for debug by executing the following Tcl command.

```
set_property mark_debug true [get_nets -hier [list {sine[*]}]]
```



**TIP:** In the Debug window, you can see the unassigned nets you just selected. In the Netlist window, you can also see the green bug icon next to each scalar or bus, which indicates that a net has the attribute `mark_debug = true` as shown in the following two figures.

Name	Driver Cell	Driver Pin
Unassigned Debug Nets (29)		
GPIO_BUTTONS_db (2)	FDRE	Q
GPIO_BUTTONS_db[0]	FDRE	Q
GPIO_BUTTONS_db[1]	FDRE	Q
GPIO_BUTTONS_dly (2)	FDRE	Q
GPIO_BUTTONS_dly[0]	FDRE	Q
GPIO_BUTTONS_dly[1]	FDRE	Q
GPIO_BUTTONS_IBUF (2)	IBUF	O
GPIO_BUTTONS_IBUF[0]	IBUF	O
GPIO_BUTTONS_IBUF[1]	IBUF	O
GPIO_BUTTONS_re (2)	FDRE	Q
GPIO_BUTTONS_re[0]	FDRE	Q
GPIO_BUTTONS_re[1]	FDRE	Q

Sources	Netlist
sinegen_demo	
Nets (60)	
GPIO_BUTTONS (2)	
GPIO_BUTTONS_db (2)	
GPIO_BUTTONS_dly (2)	
GPIO_BUTTONS_IBUF (2)	
GPIO_BUTTONS_IBUF[0]	
GPIO_BUTTONS_IBUF[1]	
GPIO_BUTTONS_re (2)	
LEDS_n (4)	
LEDS_n_OBUF (2)	
<const0>	
<const1>	

## Running the Set Up Debug Wizard

1. From the Debug window tool bar or Tools drop-down menu, select **Set Up Debug**. The Set up Debug wizard opens.

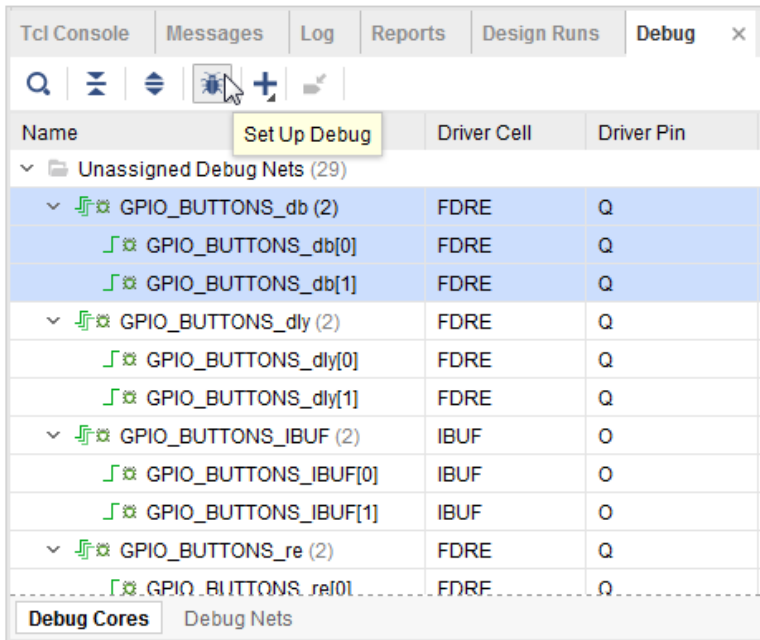

2. When the Set up Debug wizard opens, click **Next**.

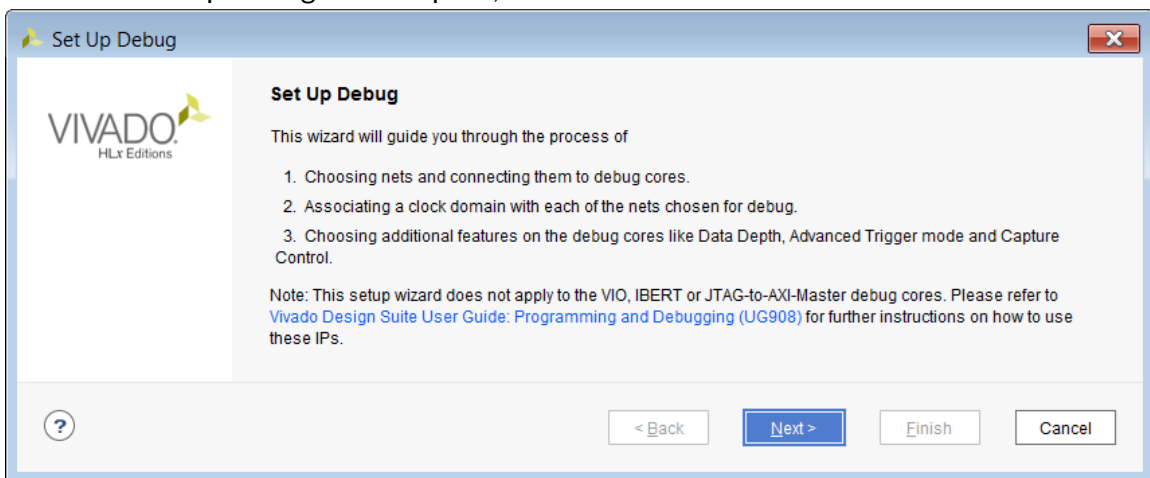

3. In the Nets to Debug page, shown in the following figure, ensure that all the nets have been added for debug and click **Next**.

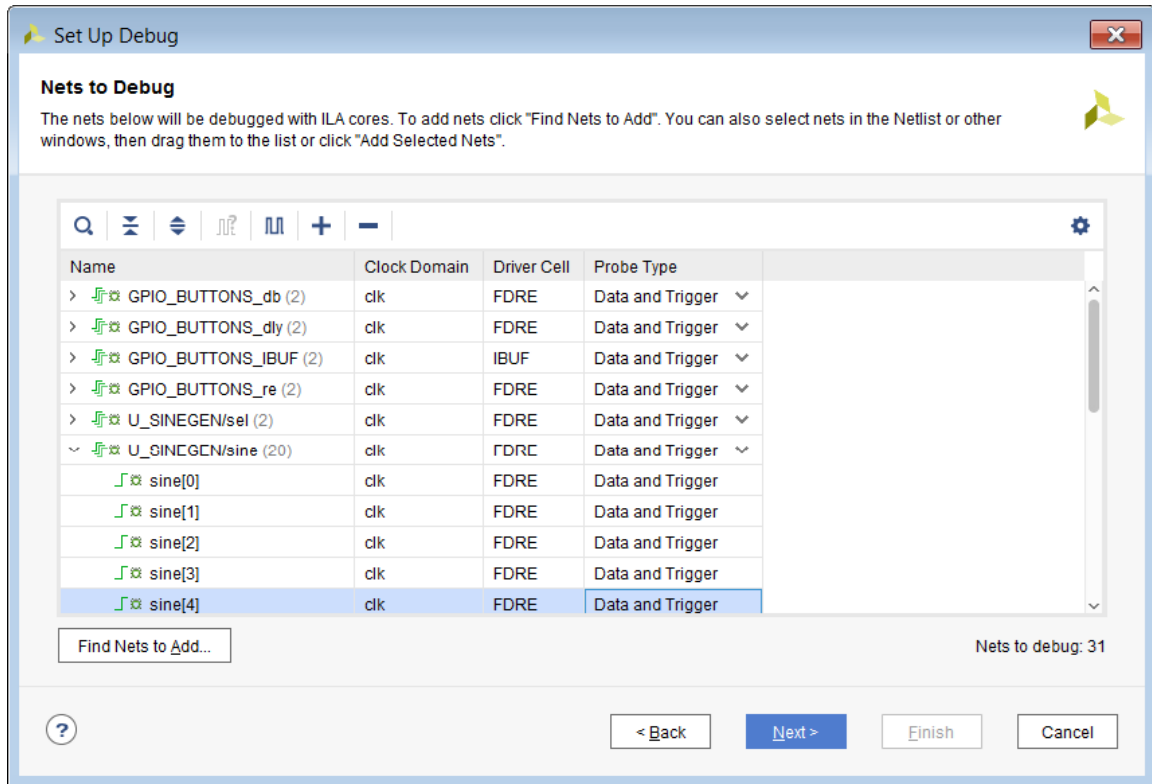

- In the ILA Core Options page, go to Trigger and Storage Settings section and select both **Capture Control** and **Advanced Trigger**. Click **Next**.
- In the Setup Debug Summary page, make sure that all the information is correct and as expected. Click **Finish**.

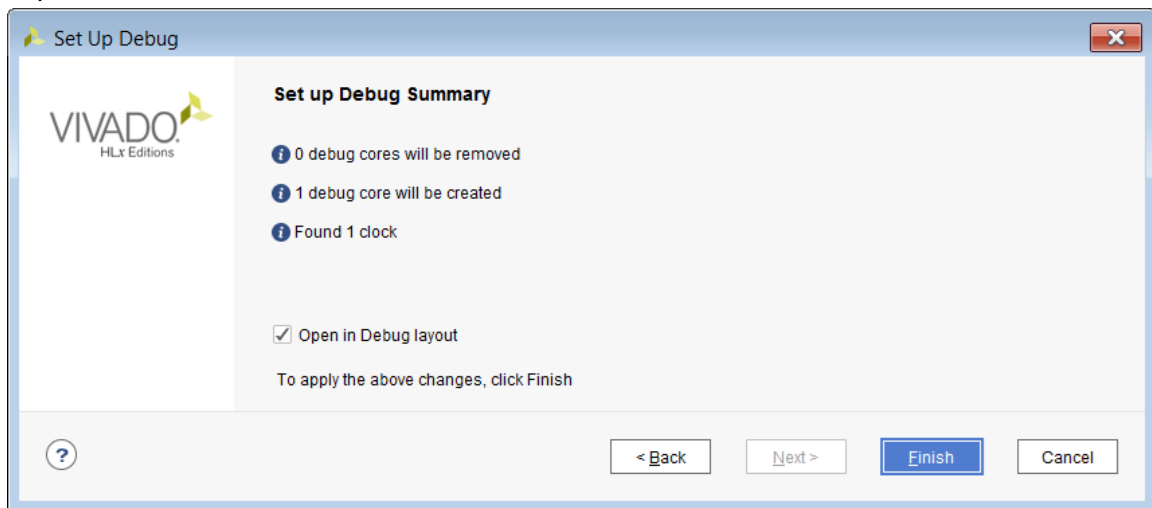

Upon clicking Finish, the relevant XDC commands that insert the ILA core(s) are generated.

## Step 4: Implementing and Generating Bitstream

1. In the Flow Navigator, under Program and Debug, click **Generate Bitstream**.

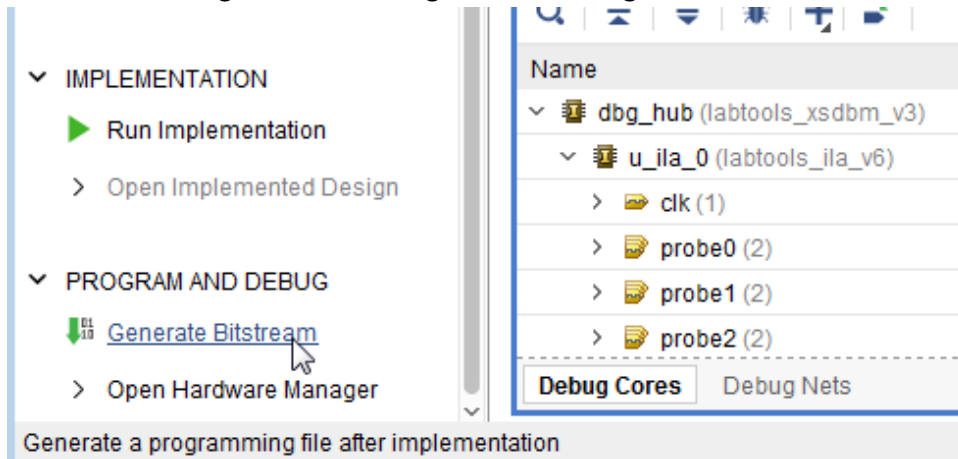

2. In the Save Project dialog box click **Save**. If a dialog box appears indicating this will cause the Synthesis results to go out of date, click **OK**. This applies the MARK\_DEBUG attributes on the newly marked nets. You can see those constraints by inspecting the `sinegen_demo_kc705.xdc` file.
3. When the No Implementation Results Available dialog box pops up, click **Yes**. In the Launch Runs dialog box, accept all of the default settings (Launch runs on local host) and click **OK**.
4. When the bitstream generation completes, the Bitstream Generation Completed dialog box pops up. Click **OK**.
5. In the dialog box asking you to close synthesized design before opening the implemented design. Click **Yes**.
6. Examine the Timing Summary report to ensure that all the specified timing constraints are met.

The screenshot shows the 'Design Timing Summary' report in Vivado. The report is organized into three columns: Setup, Hold, and Pulse Width. The data is as follows:

Setup	Hold	Pulse Width
Worst Negative Slack (WNS): 0.491 ns	Worst Hold Slack (WHS): 0.052 ns	Worst Pulse Width Slack (WPWS): 1.732 ns
Total Negative Slack (TNS): 0.000 ns	Total Hold Slack (THS): 0.000 ns	Total Pulse Width Negative Slack (TPWS): 0.000 ns
Number of Failing Endpoints: 0	Number of Failing Endpoints: 0	Number of Failing Endpoints: 0
Total Number of Endpoints: 12755	Total Number of Endpoints: 12755	Total Number of Endpoints: 6938

At the bottom of the report, it states: "All user specified timing constraints are met."

Proceed to [Lab 5: Using the Vivado Logic Analyzer to Debug Hardware](#) to complete the rest of the steps for debugging the design.

# Using the HDL Instantiation Method to Debug a Design

The HDL instantiation method is one of the two methods supported in the Vivado® tool debug probing. For this flow, you will generate an ILA IP using the Vivado IP Catalog and instantiate the core in a design manually as you would with any other IP.

---

## Step 1: Creating a Project with the Vivado New Project Wizard

To create a project, use the New Project wizard to name the project, to add RTL source files and constraints, and to specify the target device.

1. Invoke the Vivado® IDE.
2. In the Quick Start tab, click **Create Project** to start the New Project wizard. Click **Next**.
3. In the Project Name page, name the new project `proj_hdl` and provide the project location (`C:/Vivado_Debug`). Ensure that **Create project subdirectory** is selected. Click **Next**.
4. In the Project Type page, specify the Type of Project to create as **RTL Project**. Click **Next**.
5. In the Add Sources page:
  - a. Set Target Language to **VHDL**.
  - b. Click the “+” sign, and then click **Add Directories**.
  - c. In the Add Source Directories dialog box, navigate to the `/src/lab2` directory, and choose the `sine_high`, `sine_low`, `sine_mid`, and `ila_0` directories. Click **Select**.
  - d. Verify that the directories are added, and **Copy Sources into Project** is selected.
  - e. Click the “+” sign, and then click **Add File**.
  - f. In the Add Source Files dialog box, navigate to the `/src/lab2` directory and choose `debounce.vhd`, `fsn.vhd`, `sinegen.vhd`, and `sinegen_demo_inst.vhd` files. Click **OK**.
  - g. Verify that the sources and directories are added, and that **Copy Sources into Project** is selected. Click **Next**.



6. In the Add Constraints dialog box, click the “+” sign, and then click **Add Files**.
7. Navigate to `/src/lab1` directory and select `sinegen_demo_kc705.xdc`. Click **Next**.
8. In the Default Part dialog box, specify the **xc7k325tffg900-2** part for the KC705 platform. You can also select **Boards** and then select **Kintex-7 KC705 Evaluation Platform**. Click **Next**.
9. Review the New Project Summary page. Verify that the data appears as expected, per the steps above. Click **Finish**.
10. In the Sources window in Vivado IDE, expand `sinegen_demo_inst` to see the source files for this lab. Note that `ila_0` core has been added to the project.

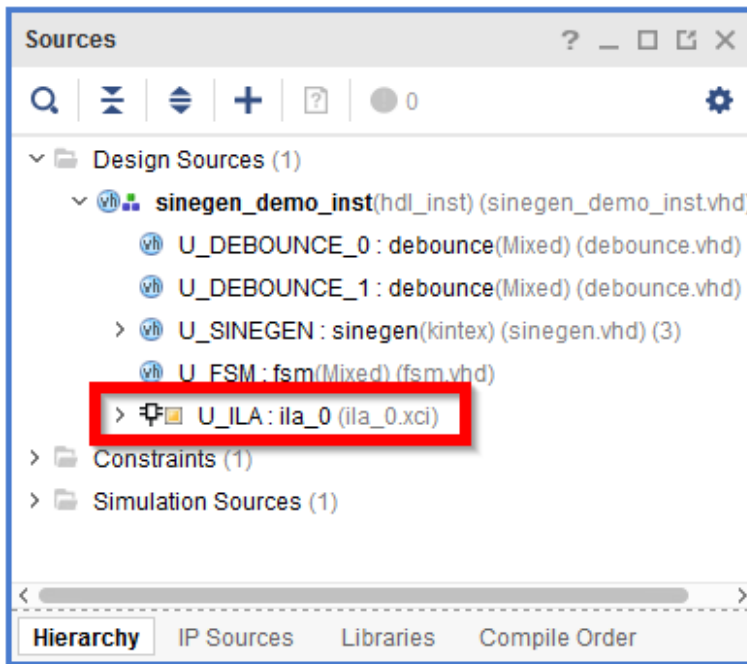

11. Double-click the `sinegen_demo_inst.vhd` file, shown in the following figure to open it and inspect the instantiation and port mapping of the ILA core in the HDL code.

```

-----
-- ILA
-----
U_ILA : ila_0
  port map
  (
    CLK => clk,
    PROBE0 => sineSel,
    PROBE1 => sine,
    PROBE2 => GPIO_BUTTONS_db,
    PROBE3 => GPIO_BUTTONS_re,
    PROBE4 => GPIO_BUTTONS_dly,
    PROBE5 => GPIO_BUTTONS
  );

```

## Step 2: Synthesize Implement and Generate Bitstream

1. From the Program and Debug drop-down list, in Flow Navigator, click **Generate Bitstream**. This will synthesize, implement and generate a bitstream for the design.

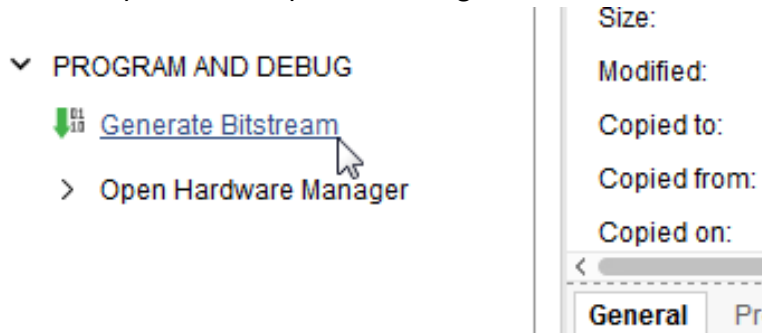

2. The No Implementation Results Available dialog box appears. Click **Yes**. In the Launch Runs dialog box, accept all of the default settings (Launch runs on local host) and click **OK**.
3. After bitstream generation completes, the Bitstream Generation Completed dialog box appears. Open Implemented Design is selected by default. Click **OK**.
4. In the Design Timing Summary window, ensure that all timing constraints are met.

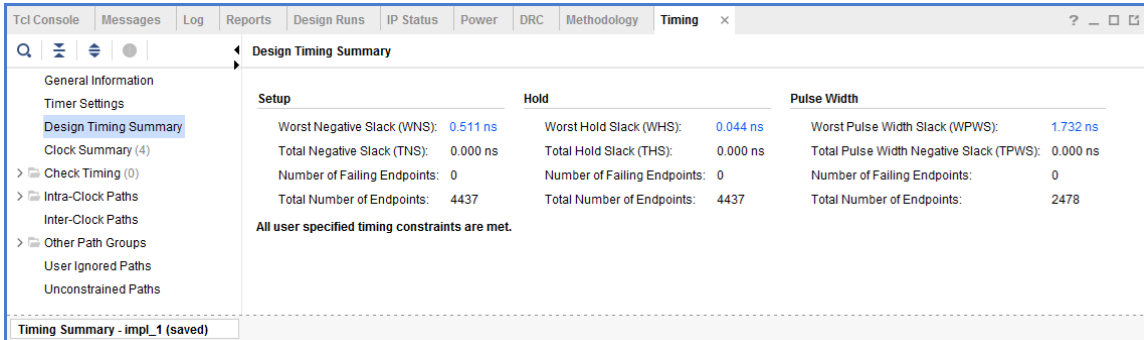

5. Proceed to [Lab 5: Using the Vivado Logic Analyzer to Debug Hardware](#) chapter to complete the rest of this lab.

## Lab 3

# Using a VIO Core to Debug a Design in Vivado Design Suite

The Virtual Input/Output (VIO) core is a customizable core that can both monitor and drive internal FPGA signals in real time. The number and width of the input and output ports are customizable in size to interface with the FPGA design. Because the VIO core is synchronous to the design being monitored and/or driven, all design clock constraints that are applied to your design are also applied to the components inside the VIO core. Run time interaction with this core requires the use of the Vivado® tool's logic analyzer feature. The following figure is a block diagram of the new VIO core.

Figure 2: VIO Block Diagram

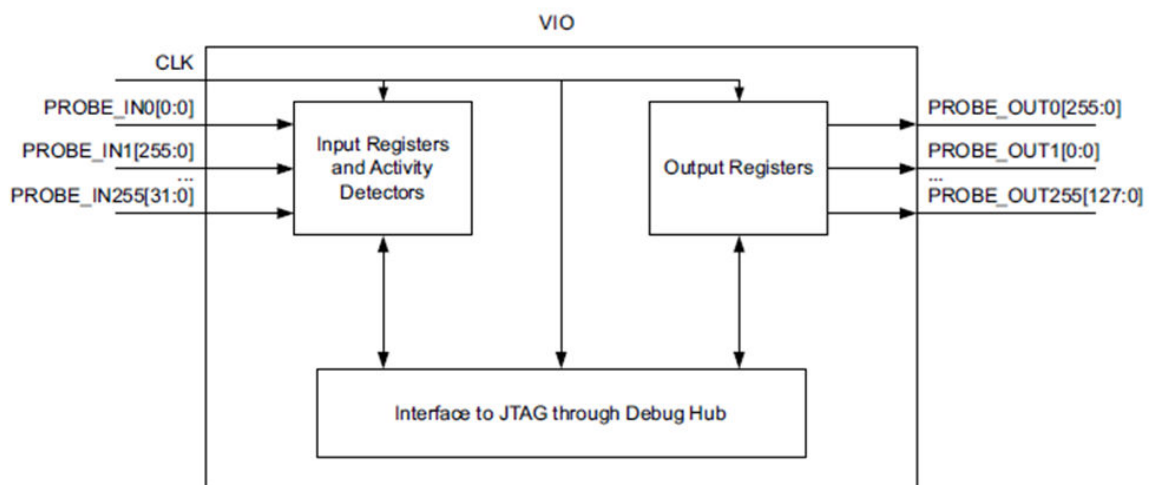

This lab walks you through the steps of instantiating and configuring the VIO core. It walks you through the steps of connecting the I/Os of the design to the VIO core. This way, you can debug your design when you do not have access to the hardware or the hardware is remotely located.

The following ports are created:

- One four-bit PROBE\_IN0 port. This has two bits to monitor the two-bit Sine Wave selector outputs from the finite state machine (FSM) and other two bits to mimic the state of the other two LEDs on the board. You will configure these four-bit signals as LEDs during run time to mimic the LEDs displayed on the KC705 board.

- One two-bit PROBE\_OUT0 port to drive the input buttons on the FSM. You will configure it so one bit can be used as a toggle switch during run time to mimic PUSH\_BUTTON switch SW3, and the second bit will be used as PUSH\_BUTTON switch SW6.

---

## Step 1: Creating a Project with the Vivado New Project Wizard

To create a project, use the New Project wizard to name the project, add RTL source files and constraints, and specify the target device.

1. Invoke Vivado IDE.
2. In the Quick Start tab, click **Create Project** to start the New Project wizard. Click **Next**.
3. In the Project Name page, name the new project **proj\_hdl\_vio** and provide the project location (`C:/Vivado_Debug`). Ensure that the **Create project subdirectory** is selected. Click **Next**.
4. In the Project Type page, specify the Type of Project to create as **RTL Project**. Click **Next**.
5. In the Add Sources page:
  - a. Set Target Language to **VHDL**.
  - b. Click **Add Files**.
  - c. In the Add Source Files dialog box, navigate to the `/src/lab3` directory.
  - d. Select all VHD source files, and click **OK**.
  - e. Verify that the files are added, and **Copy Sources into Project** is selected.
6. Click the “+” sign, and then click **Add Directories**.
7. In the Add Source Directories dialog box, navigate to the `/src/lab3` directory and choose the **sine\_high**, **sine\_low**, **sine\_mid**, and **ila\_0** directories. Click **Select**.
8. Verify that the directories are added and **Copy sources into project** is selected. Click **Next**.
9. In the Add Constraints dialog box, click the “+” sign, and then click **Add Files**.
10. Navigate to the `/src/lab3` directory and select **sinegen\_demo\_kc705.xdc**. Click **Next**.
11. In the Default Part page, specify the **xc7k325tffg900-2** platform. You can also select **Boards** and then select **Kintex-7 KC705 Evaluation Platform**. Click **Next**.
12. Review the New Project Summary page. Verify that the data appears as expected, in accordance with the previous steps. Click **Finish**.

**Note:** It might take a moment for the project to initialize.

- In the Sources window in Vivado IDE, expand `sinegen_demo_inst_vio` to see the source files for this lab. Note that the `ila_0` core has been added to the project. However, `vio_0` (the VIO core) is missing.

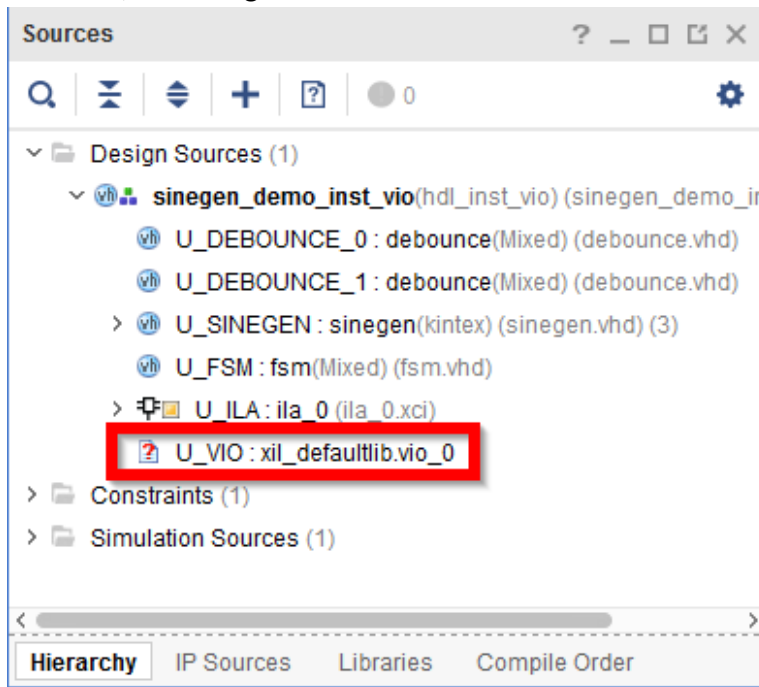

- Instantiate and configure this VIO core as follows. From the Flow Navigator, click **IP Catalog**, expand **Debug & Verification**, then expand **Debug**, and double-click VIO. The Customize IP dialog box opens.
- On the General Options tab, leave the Component Name as its default value of `vio_0`, set Input Probe Count to **1**, Output Probe Count to **1**, and select the **Enable Input Probe Activity Detectors** check box.

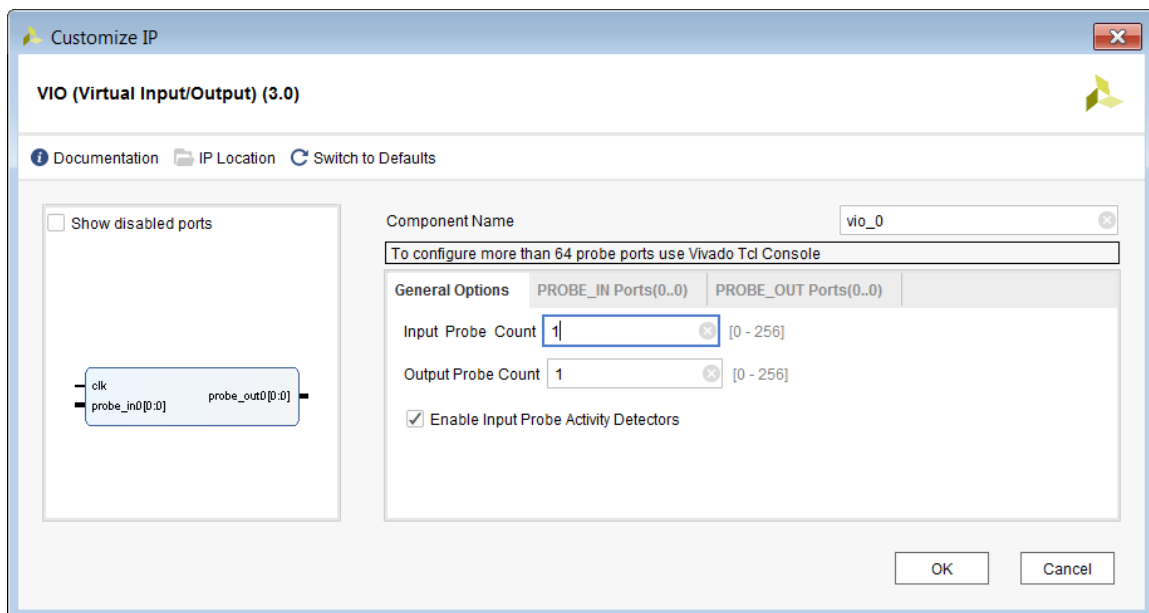

16. On the PROBE\_IN Ports tab, set Probe Width to 4.

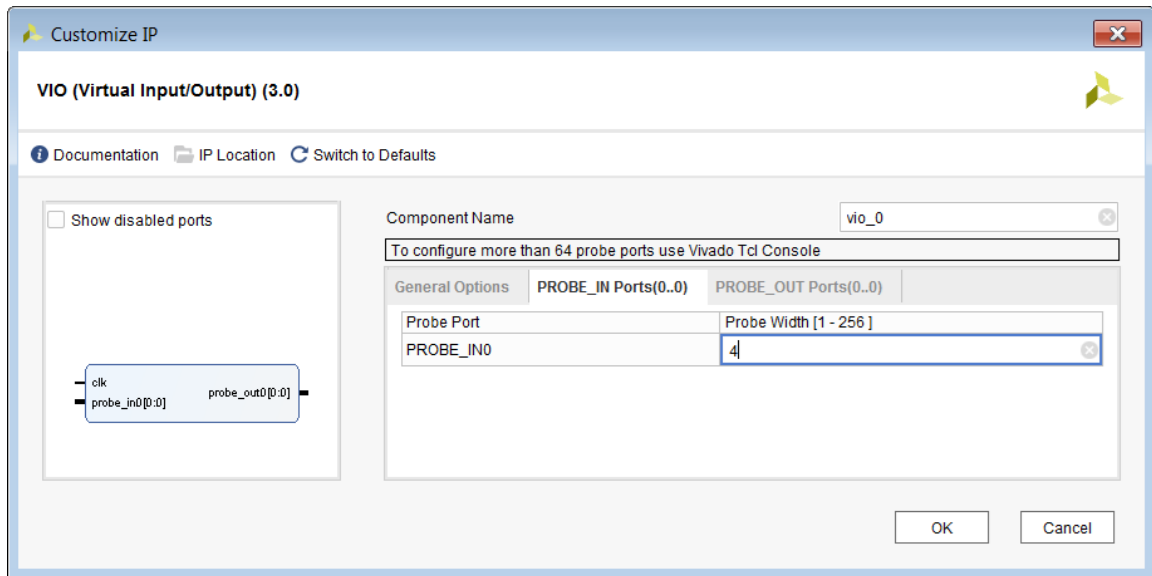

17. On the PROBE\_OUT Ports tab, set Probe Width to 2 and Initial Value to 0x0.

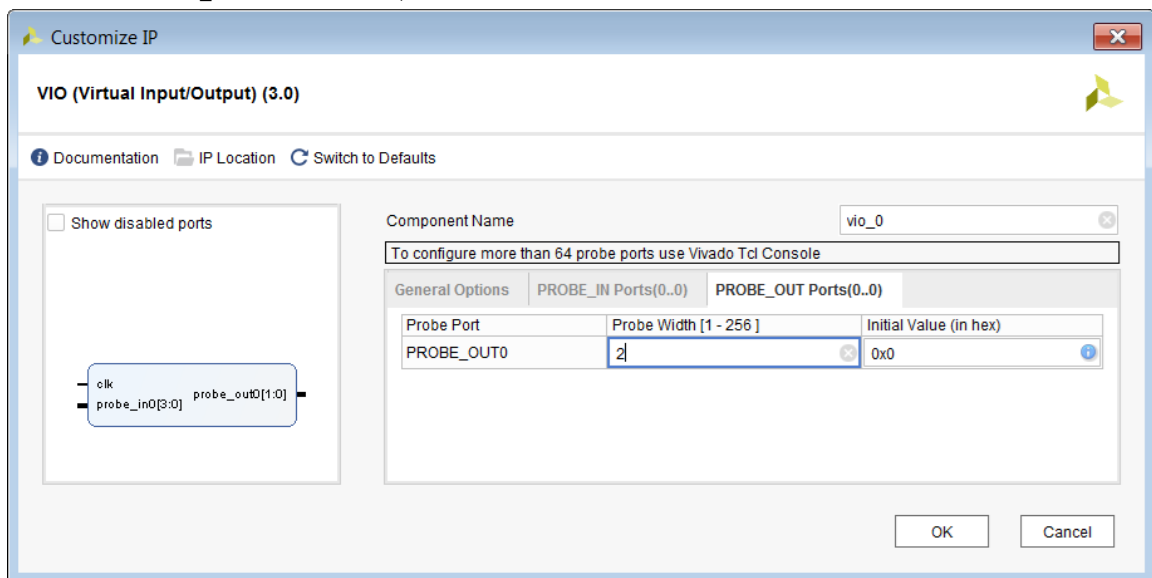

18. Click **OK** to generate the IP. The Generate Output Products dialog box appears. Click **Generate**. An additional dialog box may appear indicating that an out-of-context module run has been launched, if so click **OK**.

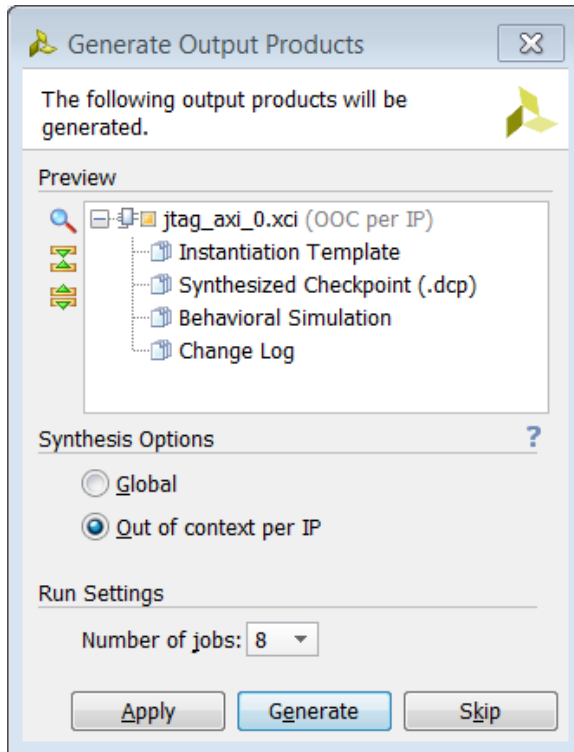

Output product generation should take less than a minute. At this point, you have finished customizing the VIO. This core has already been instantiated in the top level design.

```

-----
-- VIO
-----
U_VIO : vio_0
  port map
  (
    CLK => clk,
    PROBE_IN0(3) => DONT_EAT,
    PROBE_IN0(2) => GPIO_BUTTONS_re(1),
    PROBE_IN0(1 downto 0) => sineSel,
    PROBE_OUT0(1) => push_button_reset,
    PROBE_OUT0(0) => push_button_vio
  );

```

At this point, the Sources window should look as shown in the following figure.

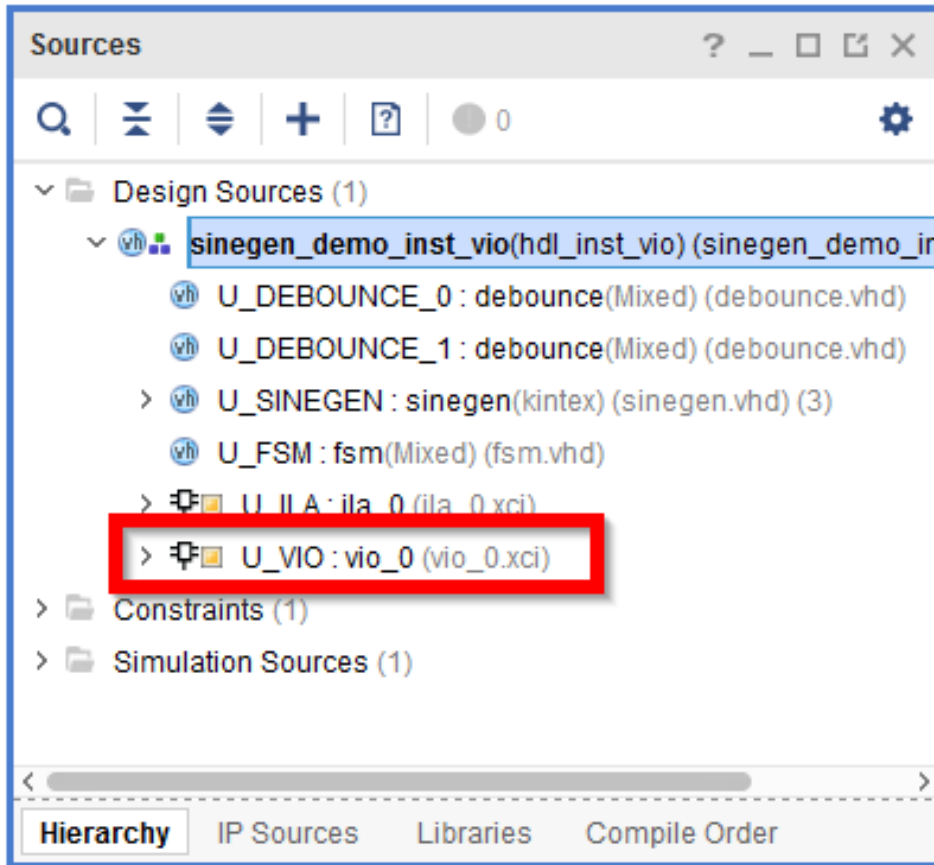

19. Double-click `sinegen_demo_inst.vhd` in the Sources window to open it, and inspect the instantiation and port mapping of the ILA core in the HDL code.

---

## Step 2: Synthesize, Implement, and Generate the Bitstream

1. From the Program and Debug drop-down list in Flow Navigator, click **Generate Bitstream**. This synthesizes, implements, and generates a bitstream for the design
2. The Missing Implementation Results dialog box appears. Click **OK**.
3. After bitstream generation completes, the Bitstream Generation Completed dialog box appears. Open Implemented Design is selected by default. Click **OK**.
4. Inspect the Timing Summary report and make sure that all timing constraints have been met.



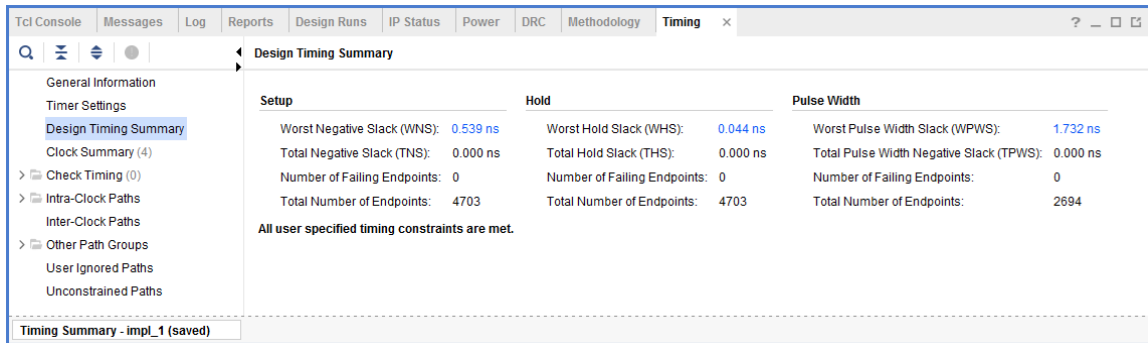

- Proceed to [Lab 5: Using the Vivado Logic Analyzer to Debug Hardware](#) to complete the rest of the steps for debugging the design. Then proceed to the [Verifying the VIO Core Activity \(Only Applicable to Lab 3\)](#) section in Lab 5 Step 2 to complete the rest of this lab.

## Lab 4

# Using the Synplify Pro Synthesis Tool and Vivado Design Suite to Debug a Design

This simple tutorial shows how to do the following:

- Create a Synplify Pro project for the wave generator design.
- Mark nets for debug in the Synplify Pro constraints file as well as VHDL source files.
- Synthesize the Synplify Pro project to create an EDIF netlist.
- Create a Vivado® project based on the Synplify Pro netlist.
- Use the Vivado IDE to setup and debug the design from the synthesized design using Synplify Pro.

---

## Step 1: Create a Synplify Pro Project

1. Launch Synplify Pro and select **File** → **New**.
2. Set File Type to **Project File (Project)** as highlighted in the following figure.
3. In the New File Name box, enter **synplify\_1**.
4. Click **OK**.

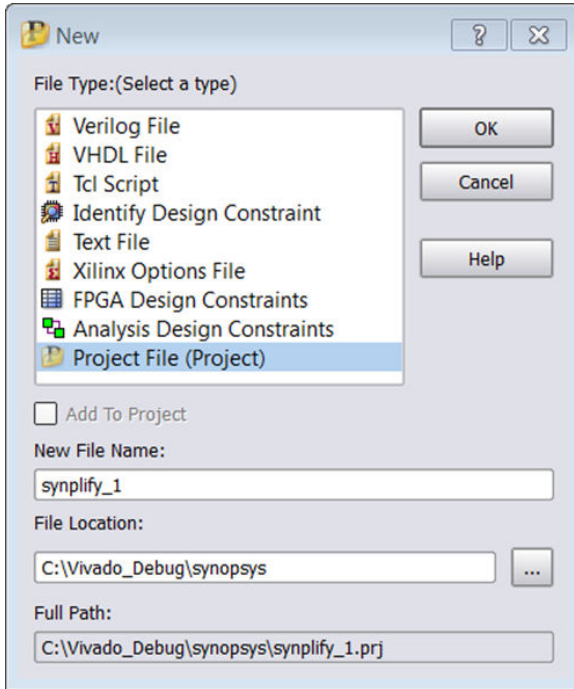

5. If you get a dialog box asking you to create a non-existing directory, click **OK**.

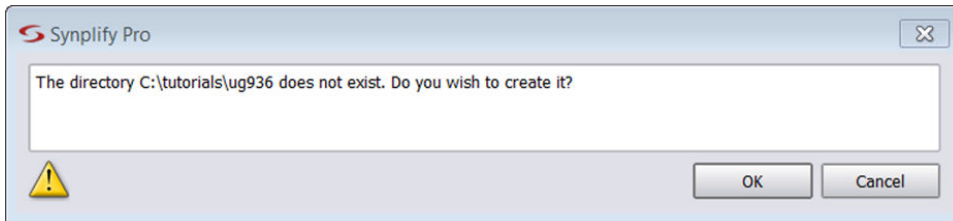

6. In the left panel of the Synplify Pro window, click **Add File** as shown in the following figure.

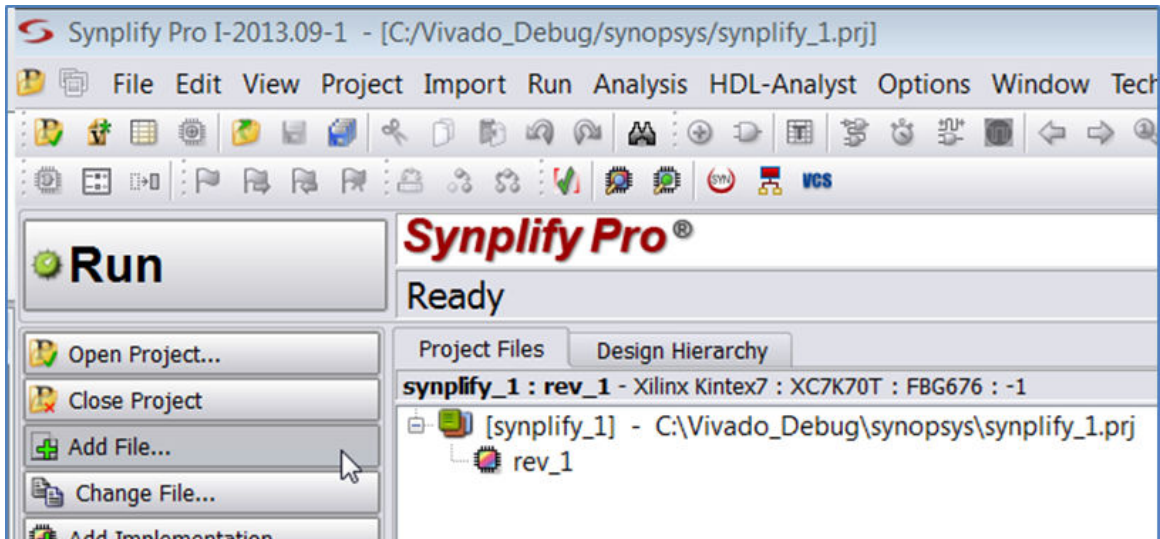

7. In the Add Files to Project dialog box, change the Files of Type to HDL File. Navigate to `C:\Vivado_Debug\src\lab4`, which shows all the VHDL source files needed for this lab. Select the following three files by pressing the Ctrl key and clicking on them.

- `debounce.vhd`
- `fsm.vhd`
- `sinegen_demo.vhd`

8. Click **Add**.

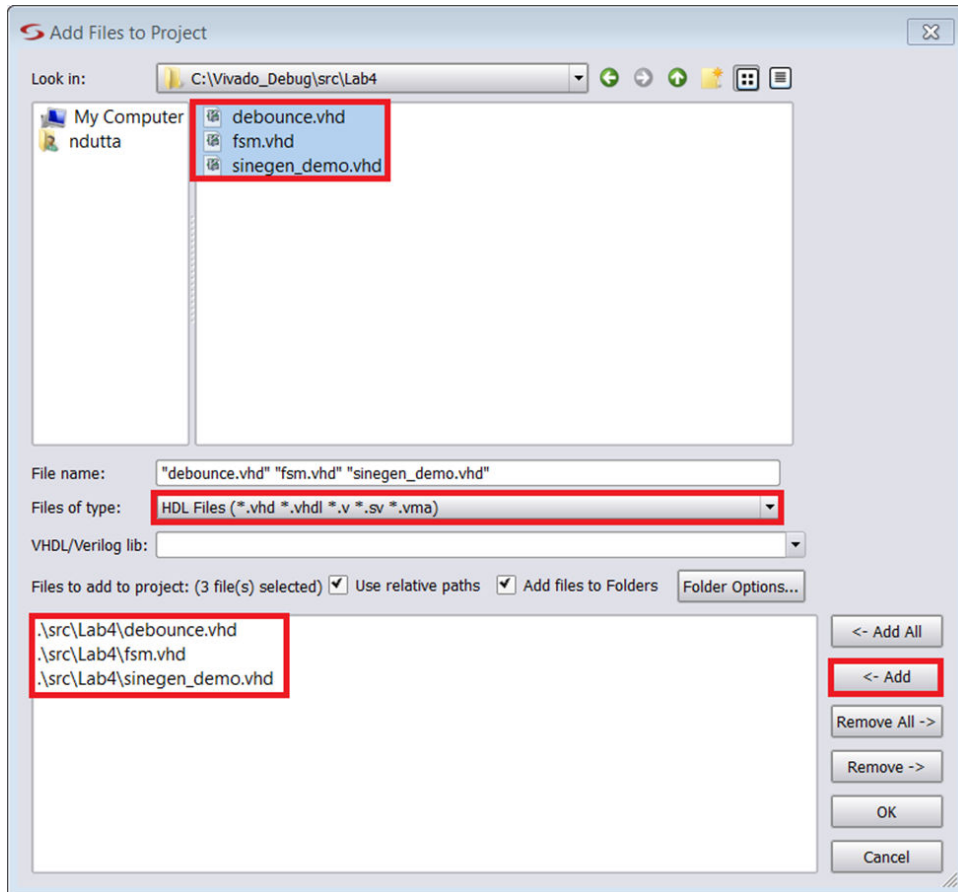

9. In the same dialog box set Files of type to Constraints Files. This shows the `synplify_1.sdc` file. Select the file and click **Add** as shown in the following figure.

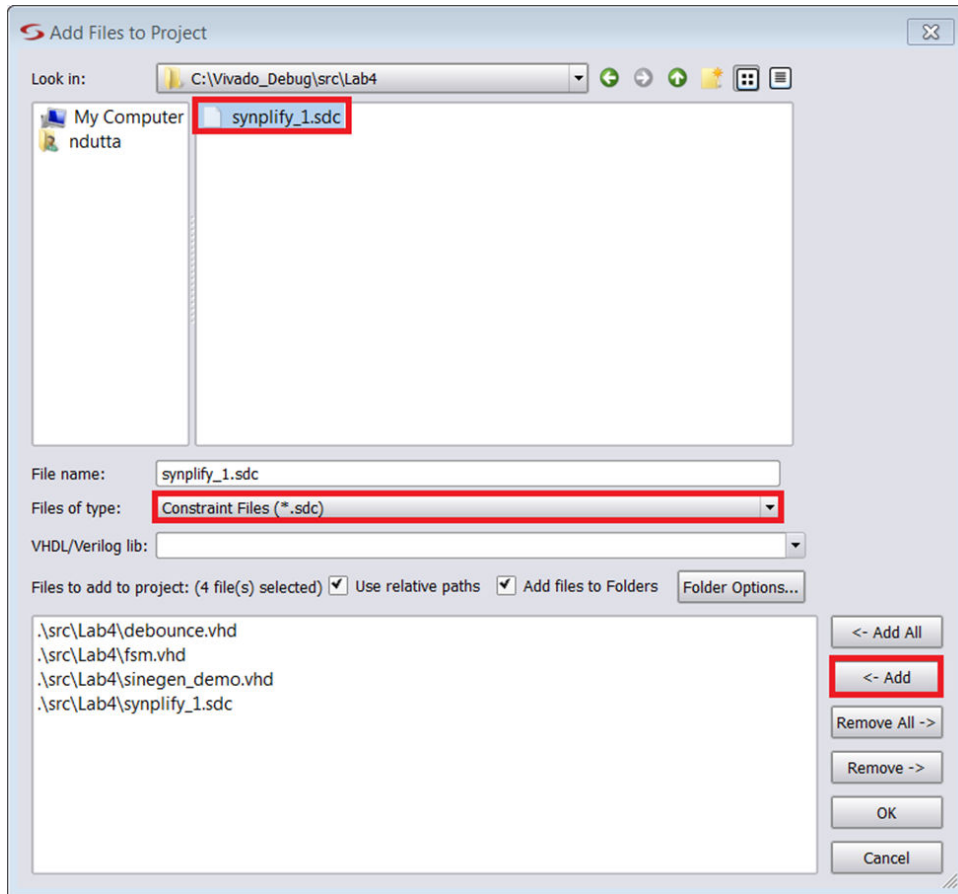

10. In the same dialog box, set Files of type to FPGA Constraint Files. This shows the synplify\_1.fdc file. Select the file and click **Add** as shown in the following figure. Click **OK**.

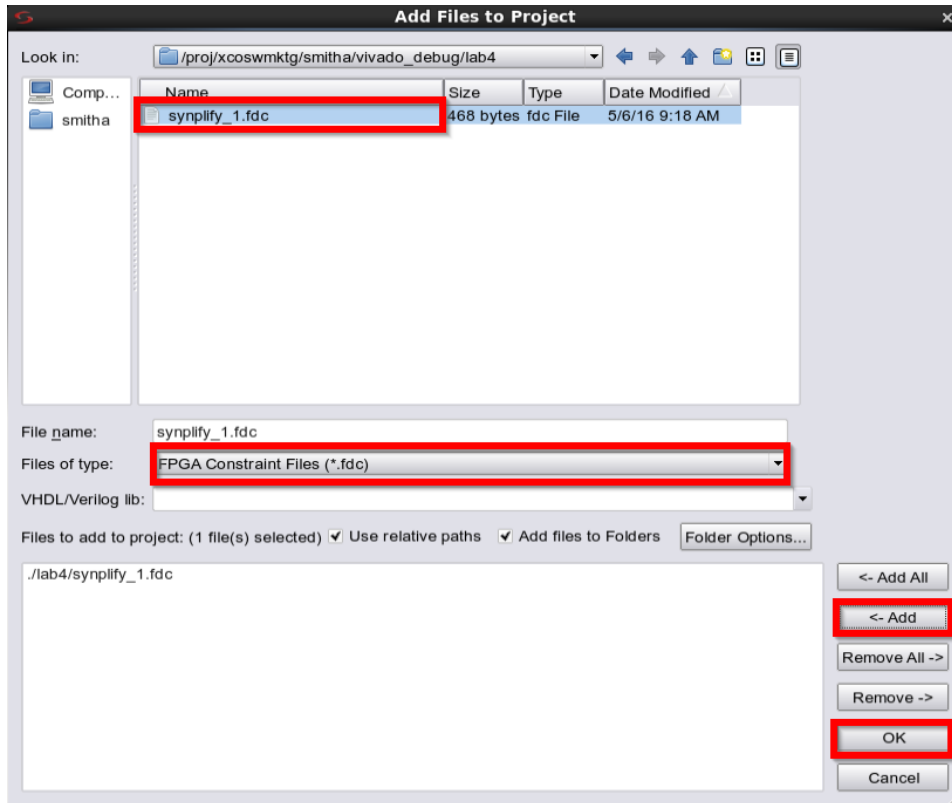

11. Now, you need to set the implementation options.

12. Click **Implementation Options** in the Synplify Pro window as shown in the following figure.

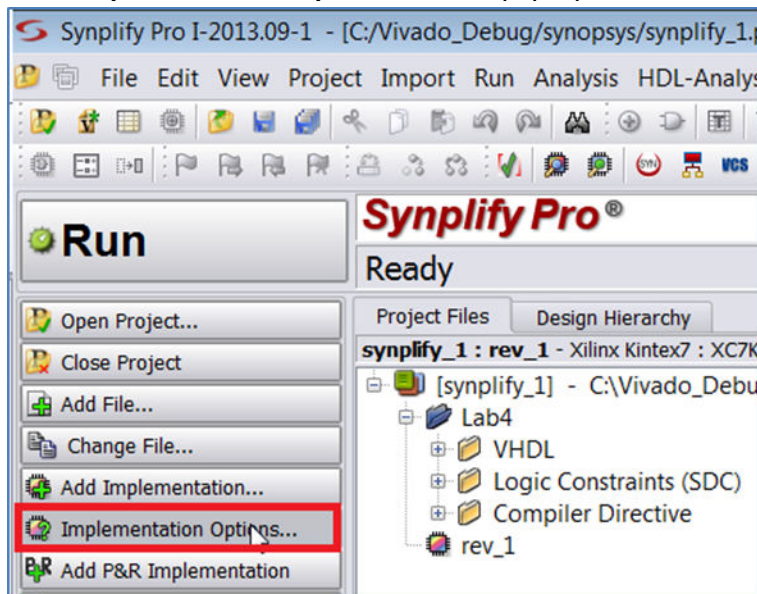

13. This brings up the Implementation Options dialog box as shown in the following figure. In the Device tab, set Technology to Xilinx Kintex7, Part to XC7K325T, Package to FFG900 and Speed to -2. Leave all the other options at their default values. Click **OK**.

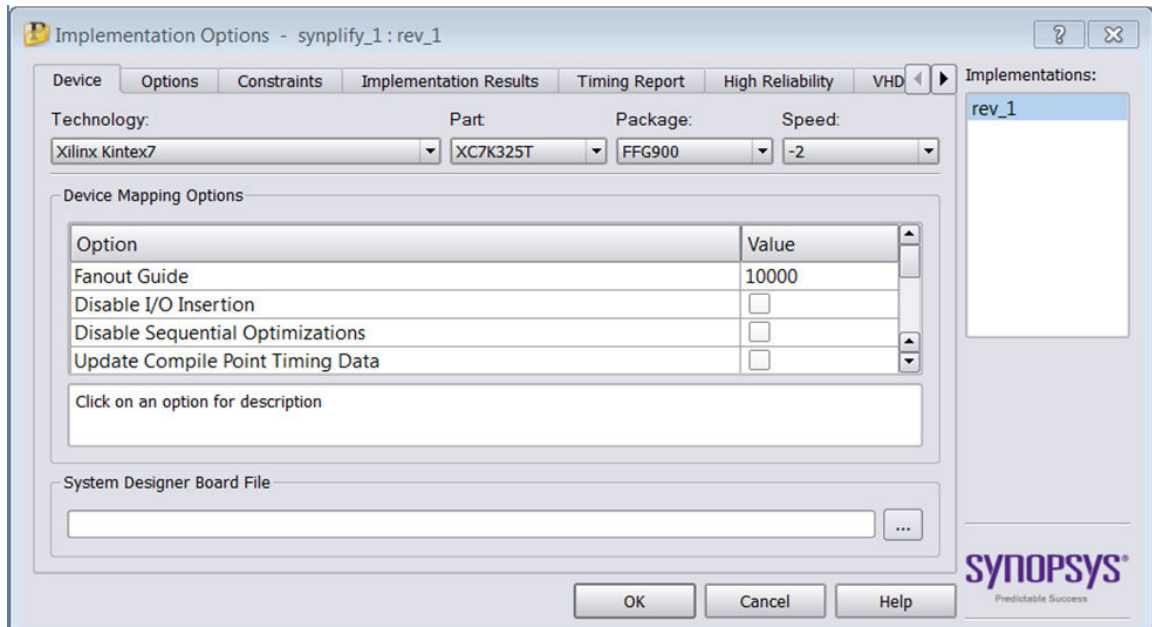

14. You need to preserve the net names that you want to debug by putting attributes in the HDL files. These attributes are already placed in the `sinegen_demo.vhd` file of this tutorial. Open the `sinegen_demo.vhd` file and inspect the lines shown.

```

-- Attributes for Synplify Pro
attribute syn_keep : boolean;
attribute syn_keep of GPIO_BUTTONS_db : signal is true;
attribute syn_keep of GPIO_BUTTONS_dly : signal is true;
attribute syn_keep of GPIO_BUTTONS_re : signal is true;

```

15. You also can specify the MARK\_DEBUG attributes in the source HDL files to mark the signals for debug, as shown in the code snippet from `sinegen_demo.vhd` file.

```

-- Add mark_debug attributes to show debug nets in the synthesized netlist
attribute mark_debug : string;
attribute mark_debug of GPIO_BUTTONS_db : signal is "true";
attribute mark_debug of GPIO_BUTTONS_dly : signal is "true";
attribute mark_debug of GPIO_BUTTONS_re : signal is "true";

```

16. The `synplify_1.sdc` file contains various kinds of constraints such as pin location, I/O standard, and clock definition. The `synplify_1.fdc` file contains directives for the compiler. Here is where the nets of interest to us that are marked for debug are located. The attribute and the nets selected for debug are shown in the following figure.

```

Attributes that are needed to mark_debug the nets that are needed to be viewed in ILA
define_attribute -comment {Mark sinegen as black box} {v:work.sinegen} {syn_black_box} {1}
define_attribute -comment {Set no_prune on sinegen} {v:work.sinegen} {syn_noprune} {1}
define_attribute -comment {Mark entire bus for debug} {i:sinegen.sine[*]} {mark_debug} {"true"}
define_attribute -comment {Mark entire bus for debug} {i:sinegen.sel[*]} {mark_debug} {"true"}

```

In the above constraints, `sinegen` has been defined as a black box by using the `syn_black_box` attribute. Second, the `syn_no_prune` attribute has been used so that the I/Os of this block are not optimized away. Finally, two nets, `sine[20:0]` and `sel[1:0]`, have been assigned the `MARK_DEBUG` attribute such that these two nets should show up in the synthesized design in Vivado® IDE for further debugging. For further information on these attributes, please refer to the Synplify Pro User Manual and Synplify Pro Reference Manual.

## Step 2: Synthesize the Synplify Project

1. Before implementing the project, you need to set the name for the output netlist file. By default, the name of the output netlist file is `synplify_1.edf`. To change the name of the output file, type the following command at the Tcl command prompt:

```
%project -result_file "../rev_1/sinegen_demo.edf"
```

You will use this file in Vivado® IDE.

2. With all the settings in place, click the **Run** button in the left panel of the Synplify Pro window to start synthesizing the design.

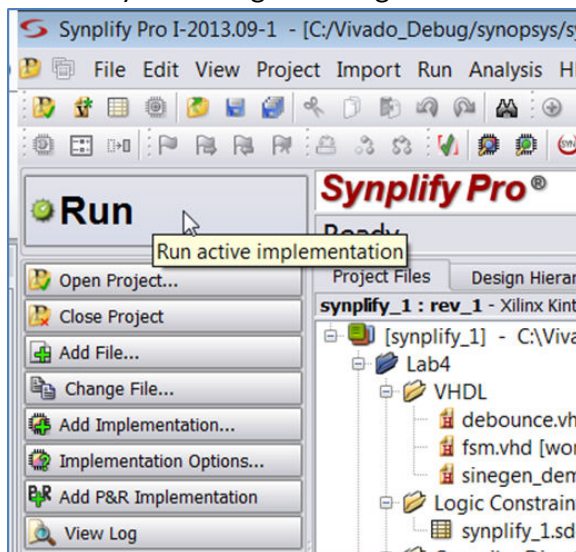

3. During synthesis, status messages appear in the Tcl Script tab. Warning messages are expected, but there should not be any Error messages. To see detailed messages, click the **Messages tab** in the bottom left-hand corner of the Synplify Pro console.
4. When synthesis completes, the output netlist is written to the file: `rev_1/sinegen_demo.edf`  
 [Optional] To view the netlist select **View → View Result File**.
5. Click **File → Save All** to save the project, then click **File → Exit**.



---

## Step 3: Create DCPs for the Black Box Created in Synplify Pro

The black box, `sinegen`, created in the Synplify Pro project, contains the Direct Digital Synthesizer IP. You need to create a synthesized design for this block. To do this, create an RTL type project in Vivado® IDE by following the steps outlined below.

1. Launch Vivado IDE.
2. Click **Create Project**. This opens up the New Project wizard. Click **Next**.
3. Under Project Name, set the project name to `proj_synplify_netlist`. Click **Next**.
4. Under Project Type, select **RTL Project**. Click **Next**.
5. Under Add Sources, click **Add Files**, navigate to the `Vivado_Debug/src/lab4` folder and select the `sinegen.vhd` file. Set Target Language to VHDL. Ensure that Copy sources into project box is selected. Click **Next**.
6. Click **Add Files**, navigate to the `Vivado_Debug/src/lab4` folder and select the `sine_high.xci`, `sine_low.xci`, and `sine_mid.xci` files. Click **Next**.
7. Under Default Parts, select Boards and then select the **Kintex-7 KC705 Evaluation Platform** and correct version for your hardware. Click **Next**.
8. Under New Project Summary, ensure that all the settings are correct. Click **Finish**.
9. Once the project has been created, in Vivado Flow Navigator, under the Project Manager folder, click **Settings**. In the dialog box, in the left panel, click **Synthesis**. From the pull-down menu on the right panel, set `-flatten_hierarchy` to none. Click **OK**.
10. In Vivado IDE Flow Navigator, under Synthesis Folder, click **Run Synthesis**.
11. When synthesis completes the Synthesis Completed dialog box appears. Select **Open Synthesized Design** and click **OK**.
12. Click **File** → **Exit** in Vivado IDE. When the OK to exit dialog box pops up, click **OK**.

---

## Step 4: Create a Post Synthesis Project in Vivado IDE

1. Launch the Vivado IDE.
2. Click **Create Project**. This opens up the New Project wizard. Click **Next**.
3. Set the Project Name to `proj_synplify`. Click **Next**.
4. Under Project Type, select Post-synthesis Project. Click **Next**.

5. Under Add Netlist Sources, click **Add Files**, navigate to the `Vivado_Debug/synopsys/rev_1` folder, and select `sinegen_demo.edf`. Click **OK**.
6. Add the netlist file created in the previous section. Click **Add Files** again, navigate to the `proj_synplify_netlist/proj_synplify_netlist.runs/synth1` folder and select `sinegen.dcp`.

Add the DCP files created for the sub-module IPs in the previous section. Click **Add Directories** again, navigate to the `proj_synplify_netlist/proj_synplify_netlist.srcs/sources_1/ip` folder and select the following:

- `sine_high`
- `sine_mid`
- `sine_low`

Click **OK** in the Add Source Files dialog box. In the Add Netlist Sources dialog box ensure that Copy Sources into Project is selected. Click **Next**.

7. Click **Add Files**, navigate to the `Vivado_Debug/src` folder, and select the `sinegen_demo_kc705.xdc` file. This file has the appropriate constraints needed for this Vivado project. Click **OK** in the Add Constraints File dialog box. In the Add Constraints (optional) dialog box ensure that Copy Constraints into Project is selected. Click **Next**.
8. Under Default Part, select **Boards** and then select **Kintex-7 KC705 Evaluation Platform** and the right version number for your hardware. Click **Next**.
9. Under New Project Summary, ensure that all the settings are correct and click **Finish**.
10. In the Sources window, ensure `sinegen_demo.edf` is selected as the top module.

## Step 5: Add More Debug Nets to the Project

1. In Vivado® IDE, in the Flow Navigator, select **Open Synthesized Design** from the Netlist Analysis folder.
2. Select the Netlist tab in the Netlist window to expand Nets. Select the following nets for debugging:
  - `GPIO_BUTTONS_c(2)`
  - `sine (20)`

After selecting all the specified nets, right-click the nets and click **Mark Debug**, as shown in the following figure.

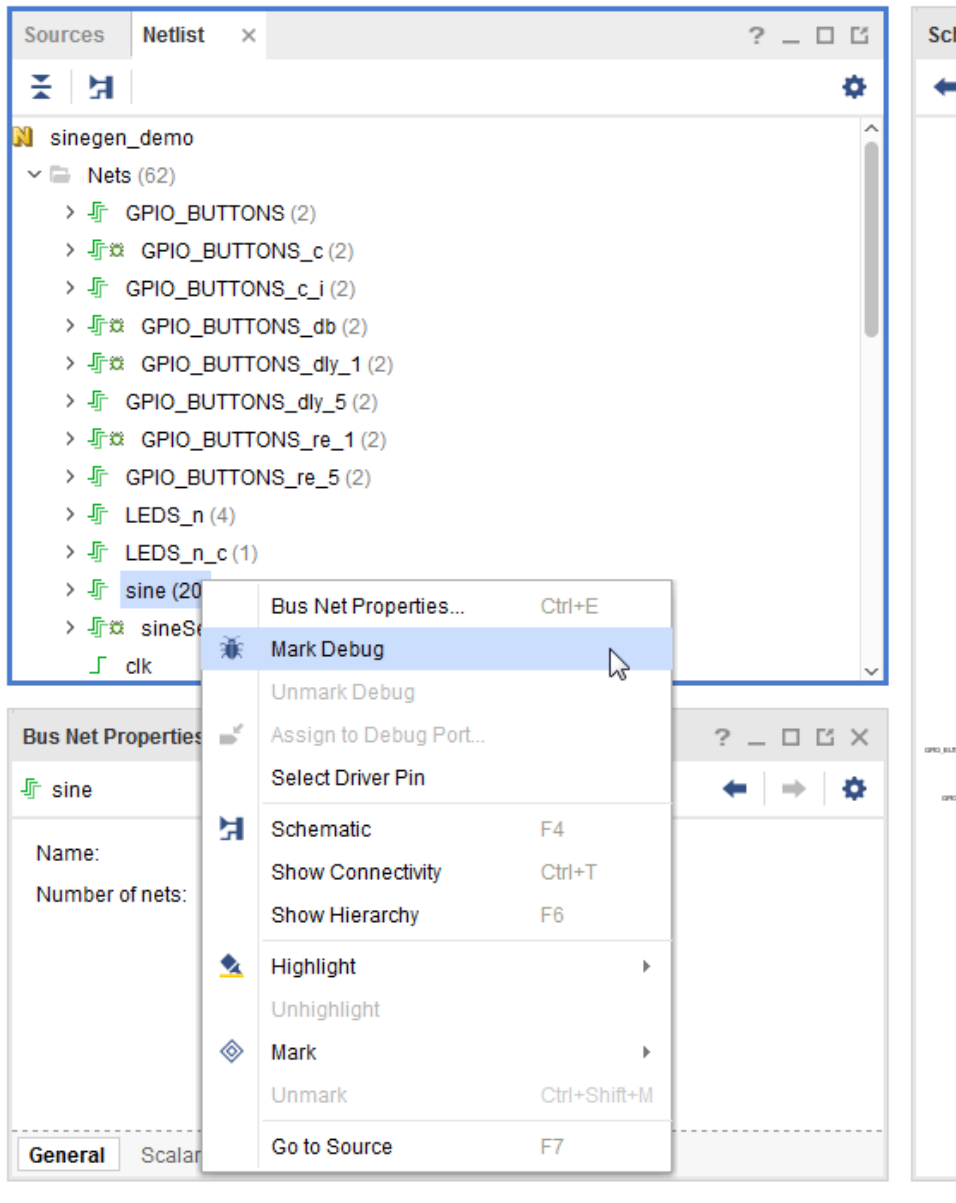

3. You should be able to see all the nets that are marked for debug, as shown in the following figure.

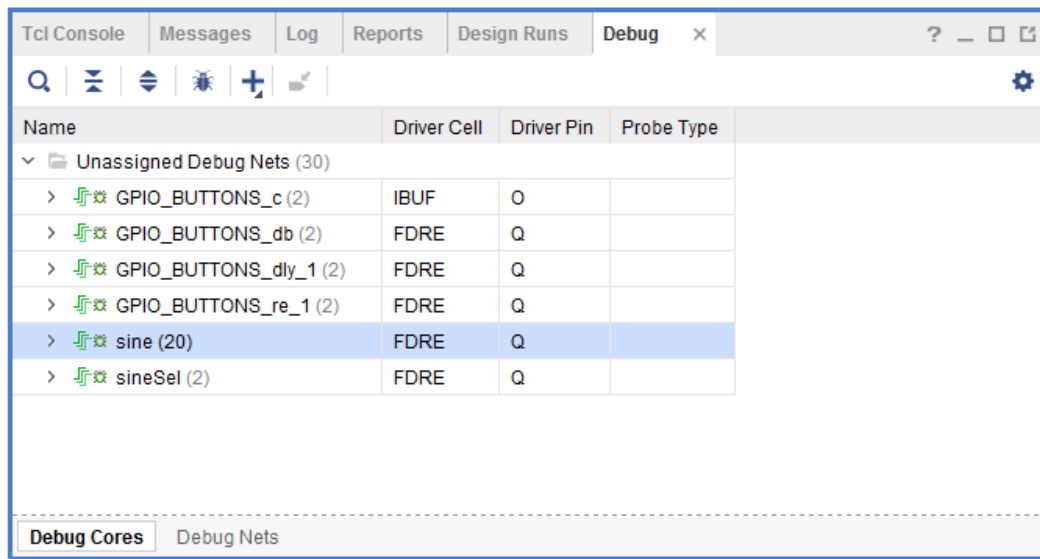

## Running the Set Up Debug Wizard

1. Click the **Set up Debug** icon in the Debug window or select the Tools menu, and select **Set up Debug**. The Set up Debug wizard opens.

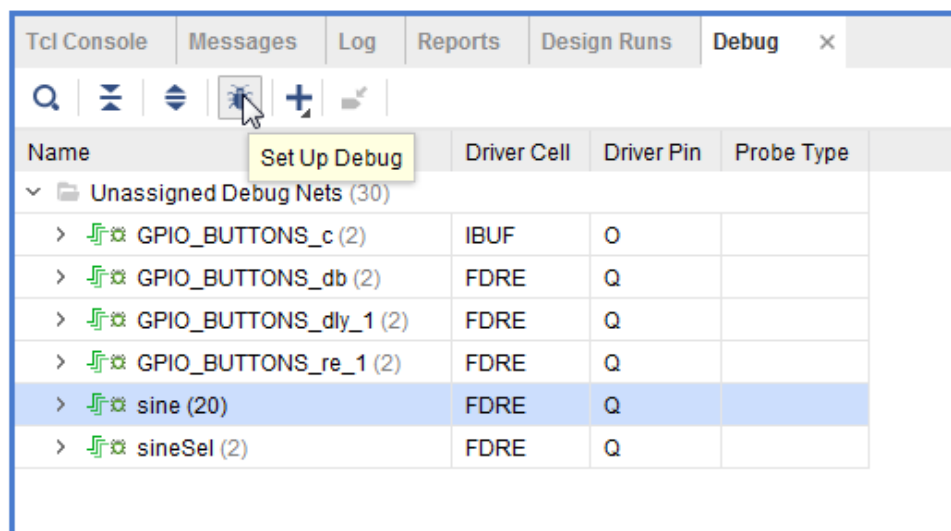

2. Click through the wizard to create Vivado® logic analyzer debug cores, keeping the default settings.

**Note:** In the Specify Nets to Debug dialog box, ensure that all the nets marked for debug have the same clock domain.

---

## Step 6: Implementing the Design and Generating the Bitstream

1. In the Flow Navigator, under the Program and Debug drop-down list, click **Generate Bitstream**.
2. In the Save Project dialog box, click **Save**.
3. When the Bitstream generation finishes, the Bitstream Generation Completed dialog box pops up and Open Implemented Design is selected by default. Click **OK**.
4. If you get a dialog box asking to close the synthesized design before opening the implemented design, click **Yes**.
5. Proceed to [Lab 5: Using the Vivado Logic Analyzer to Debug Hardware](#) to complete the rest of this lab.

## Lab 5

# Using the Vivado Logic Analyzer to Debug Hardware

The final step in debugging is to connect to the hardware and debug your design using the Integrated Logic Analyzer (ILA). Before continuing, make sure you have the KC705 hardware plugged into a machine.

In this step, you learn:

- How to debug the design using the Vivado® logic analyzer.
- How to use the currently supported Tcl commands to communicate with your target board (KC705).
- How to discover and correct a circuit problem by identifying unintended behaviors of the push-button switch.
- Useful techniques for triggering and capturing design data.

---

## Step 1: Verifying Operation of the Sine Wave Generator

After doing some setup work, you will use Vivado logic analyzer to verify that the sine wave generator is working correctly. Your two primary objectives are to verify that:

- All sine wave selections are correct.
- The selection logic works correctly.

### Target Board and Server Set Up

- **Connecting to the Target Board Remotely:** If you plan to connect remotely, you need to make sure that the KC705 board is plugged into a machine and you are running an `hw_server` application on that machine. If you plan to connect locally, skip steps 1-5 below and go directly to the Connecting to the Target Board Locally section.

1. Connect the Digilent USB JTAG cable of your KC705 board to a USB port on a Windows system.

2. Ensure that the board is plugged in and powered on.
3. Power cycle the board to clear the device.
4. Turn DIP switch positions (pin 1 on SW11, De-bounce Enable) to the OFF position.
5. Assuming you are connecting your KC705 board to a 64-bit Windows machine and you will be running the `hw_server` from the network instead of your local drive, open a `cmd` prompt and type the following:

```
<Xilinx_Install>\Vivado\2020.x\bin\hw_server
```

Leave this `cmd` prompt open while the `hw_server` is running. Note the machine name that you are using, you will use this later when opening a connection to this instance of the `hw_server` application.

- **Connecting to the Target Board Locally:** If you plan to connect locally, ensure that the KC705 board is plugged into a Windows machine and then perform the following steps:
  1. Connect the Digilent USB JTAG cable of your KC705 board to a USB port on a Windows system.
  2. Ensure that the board is plugged in and powered on.
  3. Power cycle the board to clear the device.
  4. Turn DIP switch positions (pin 1 on SW11, De-bounce Enable) to the OFF position.

## Using the Vivado Integrated Logic Analyzer

1. In the Flow Navigator, under Program and Debug, select **Open Hardware Manager**.

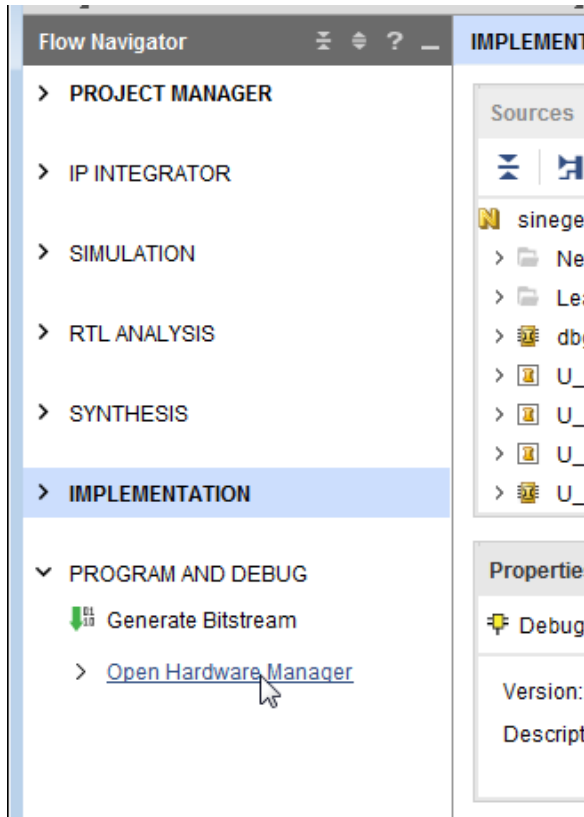

2. The Hardware Manager window opens. Click **Open Target** → **Open New Target**.

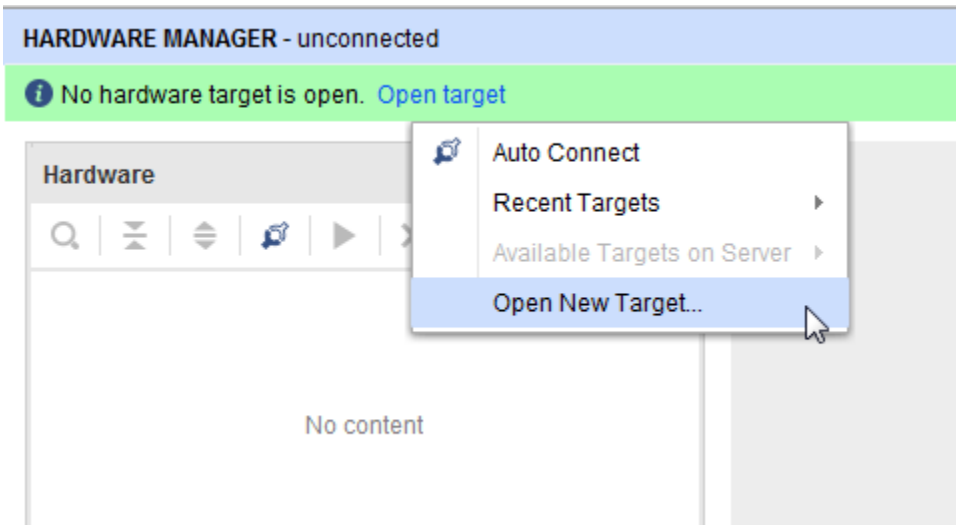

3. The Open New Hardware Target wizard opens. Click **Next**.
4. In the Hardware Server Settings page, type the name of the server (or select **Local server** if the target is on the local machine) in the Connect to field. Click **Next**.



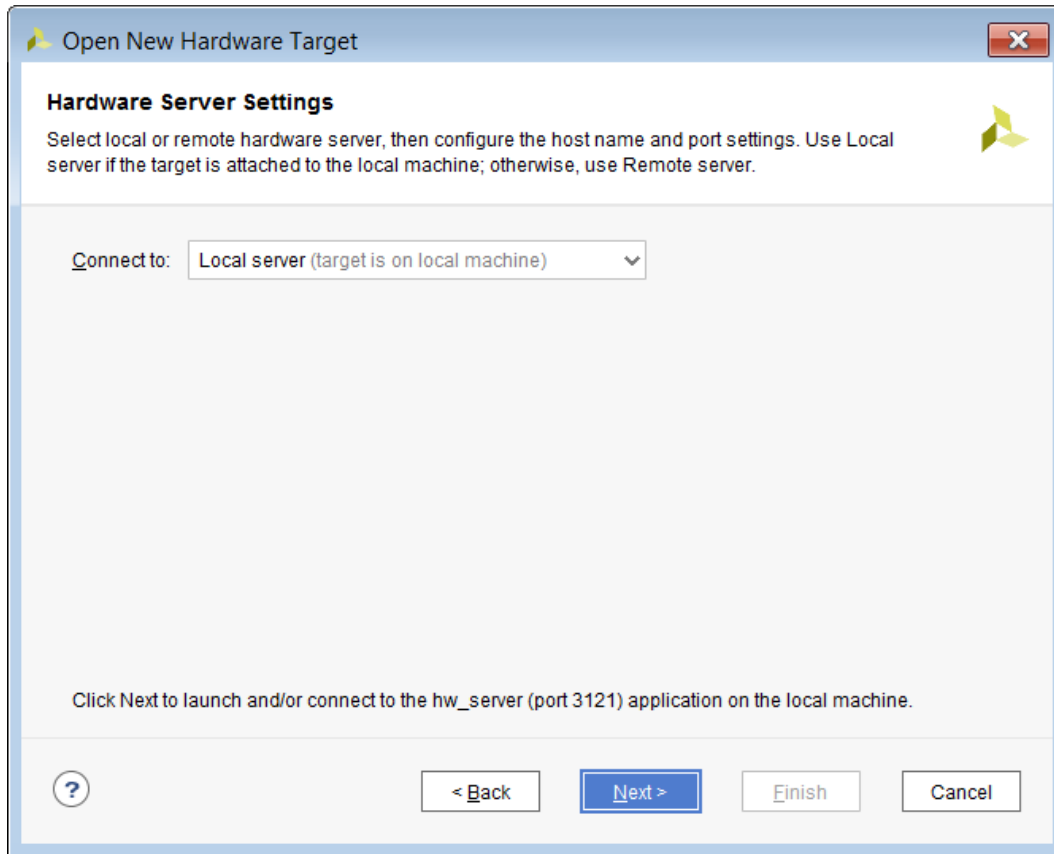

**Note:** Depending on your connection speed, this may take about 10 to 15 seconds.

5. If there is more than one target connected, you will see multiple entries in the Select **Hardware Target** page. In this tutorial, there is only one target, as shown in the following figure. Click **Next**.

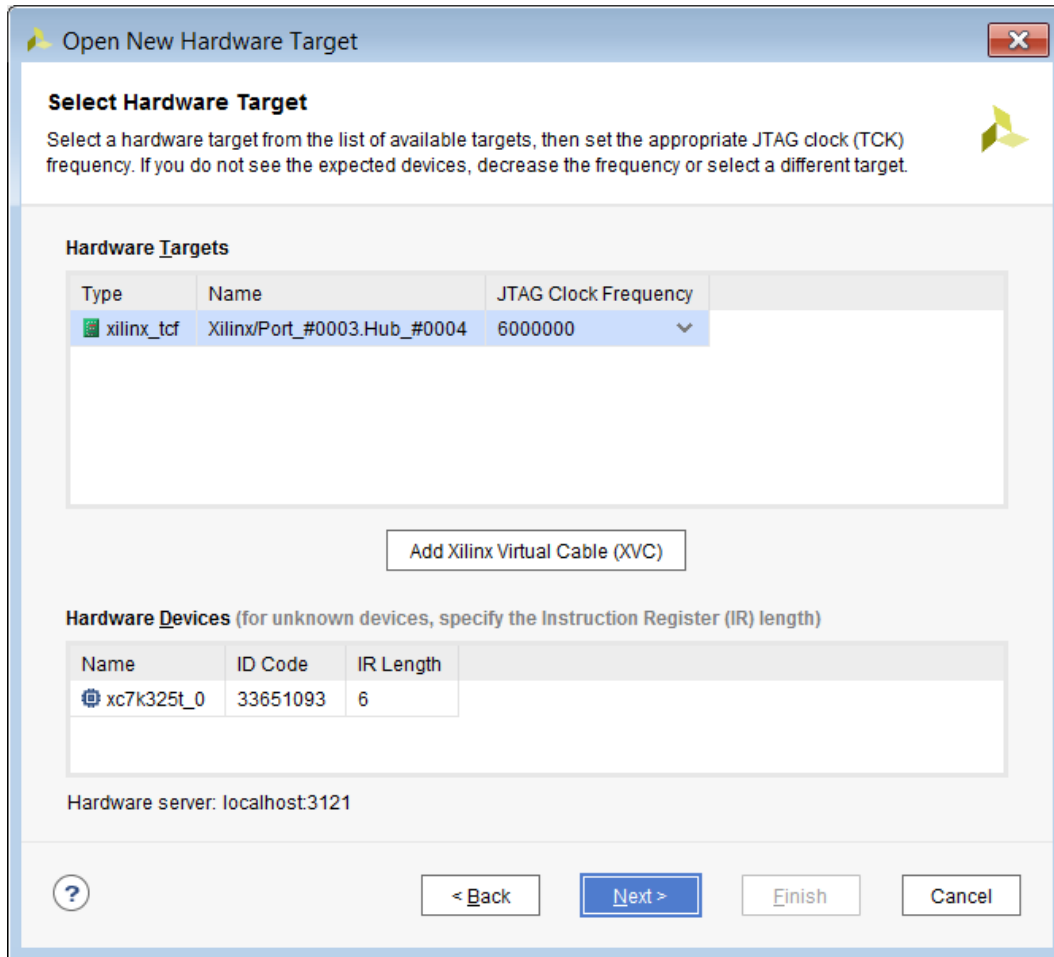

- In the Open Hardware Target Summary page, click **Finish** as shown in the following figure.

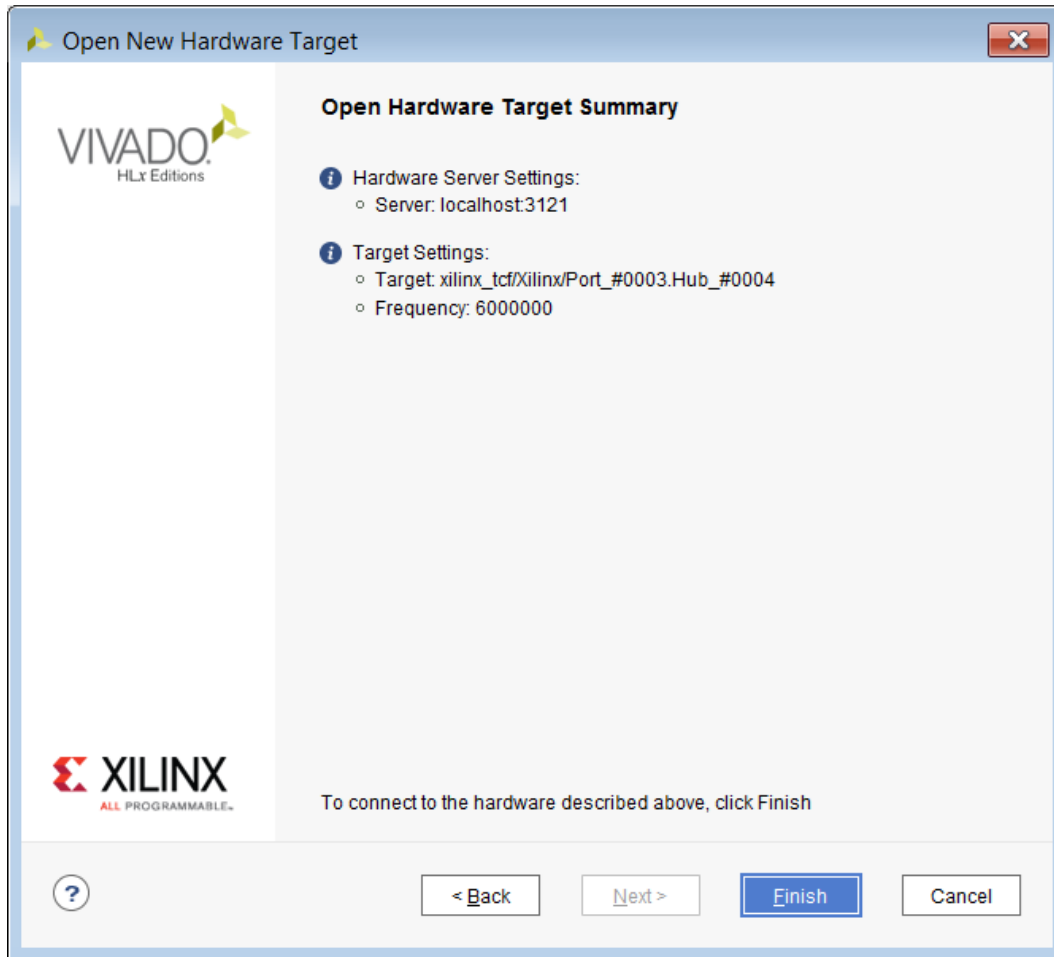

7. Wait for the connection to the hardware to complete. The dialog in following figure appears while hardware is connecting.

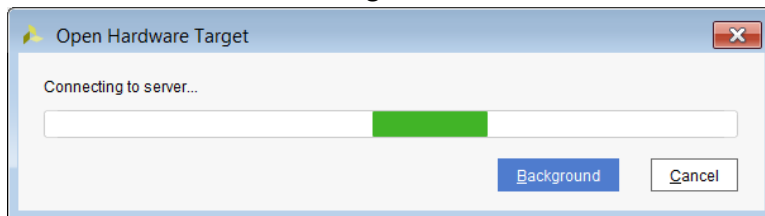

After the connection to the hardware target is made, the Hardware window appears as in the following figure.

**Note:** The Hardware tab in the Debug view shows the hardware target and XC7K325T device detected in the JTAG chain.

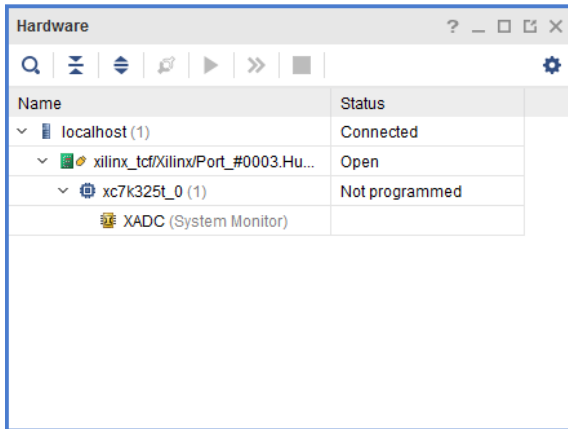

- Next, program the XC7K325T device using the previously created `.bit` bitstream by right-clicking the XC7K325T device and selecting **Program Device** as shown in the following figure.

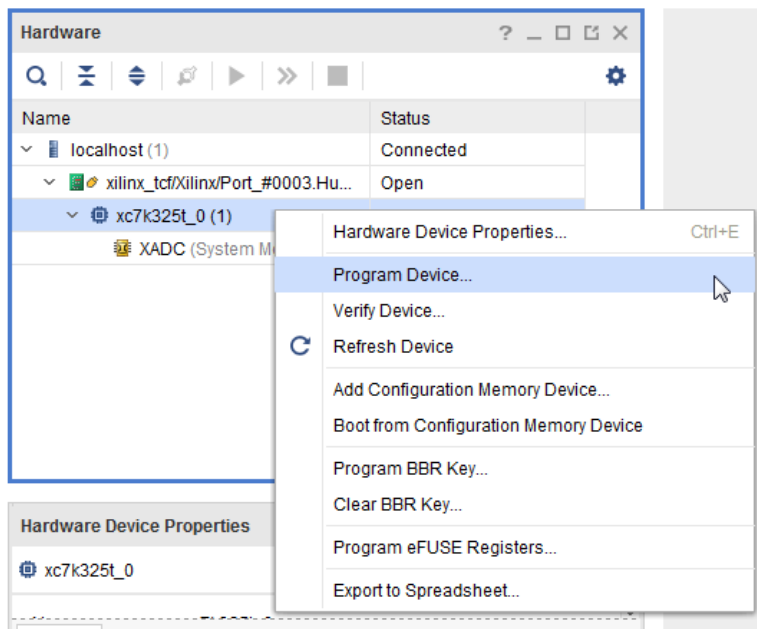

- In the Program Device dialog box verify that the `.bit` and `.ltx` files are correct for the lab that you are working on and click **Program** to program the device as shown in the following figure.

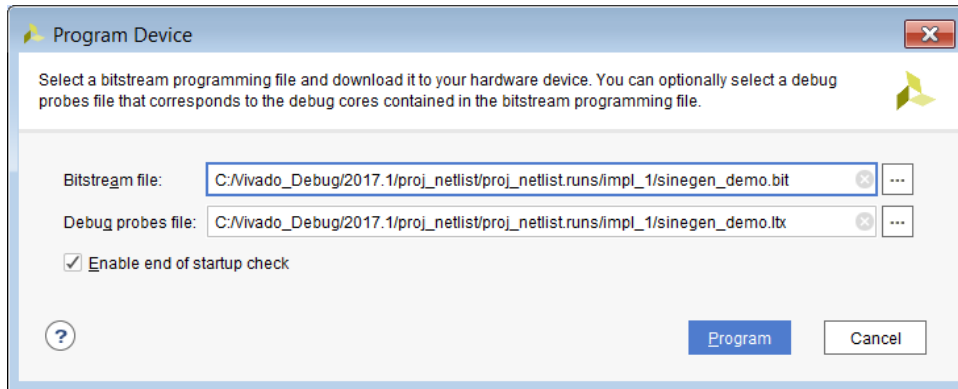

**CAUTION!** The file paths of the bitstream and debug probes to be programmed will be different for different labs. Ensure that the relative paths are correct.

**Note:** Wait for the program device operation to complete. This may take few minutes.

10. Ensure that an ILA core was detected in the Hardware panel of the Debug view.

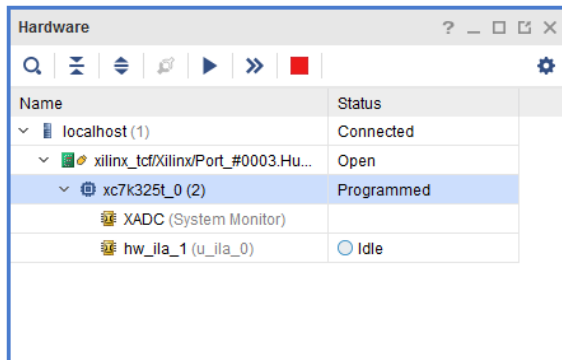

11. The Integrated Logic Analyzer dashboard opens, as shown in the following figure.

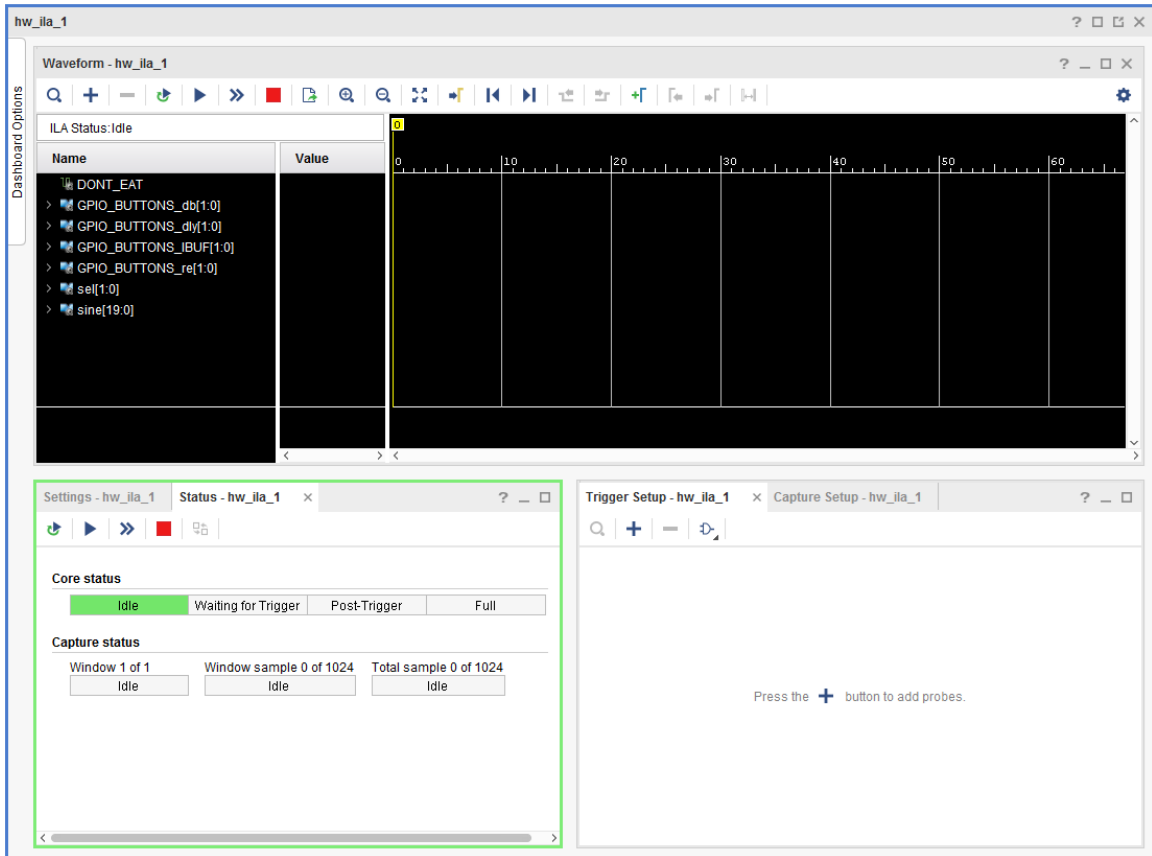

## Verifying Sine Wave Activity

1. In the Hardware window, click **Run Trigger Immediate** to trigger and capture data immediately as shown in shown in the following figure.

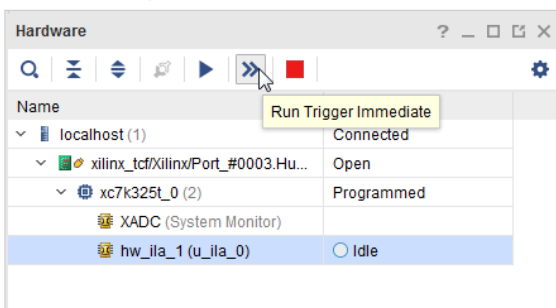

2. In the Waveform window, verify that there is activity on the 20-bit sine signal as shown in the following figure.

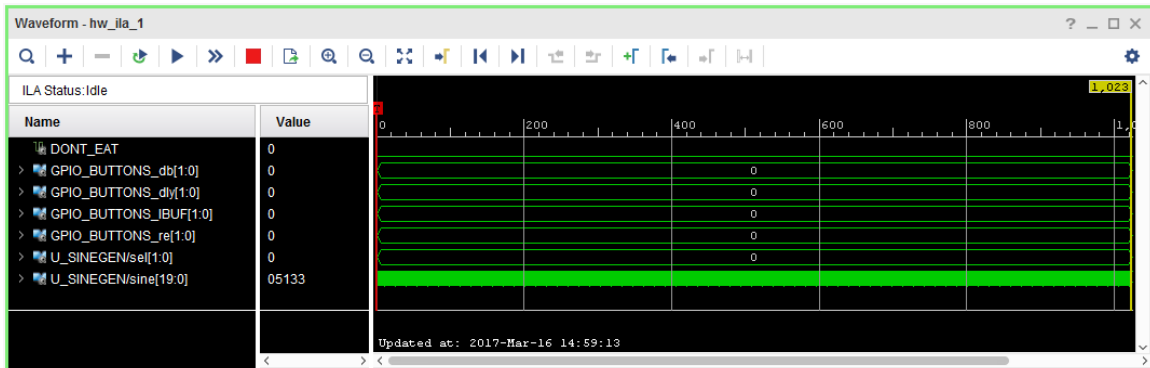

## Displaying the Sine Wave

1. Right-click **U\_SINEGEN/sine[19:0]** signals, and select **Waveform Style** → **Analog** as shown in the following figure.

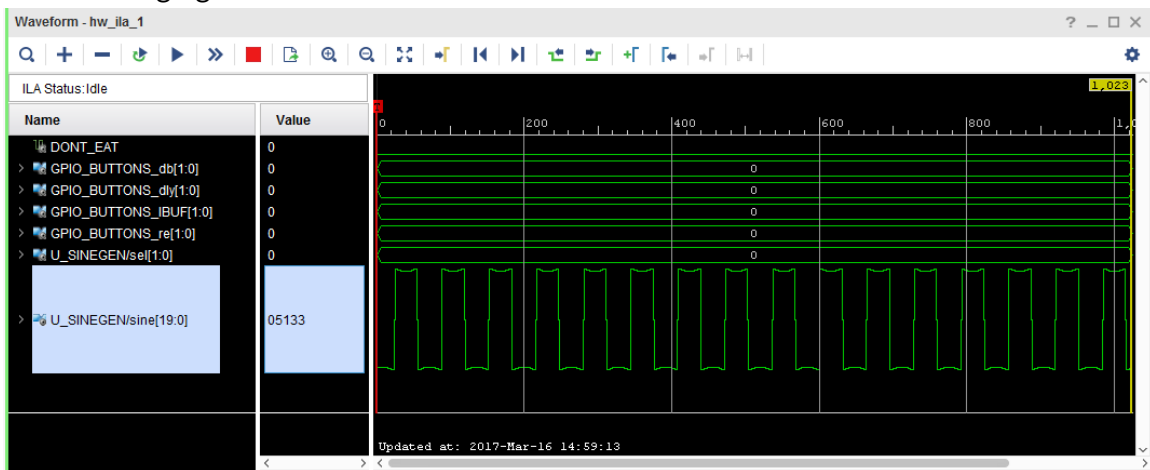

**CAUTION!** The waveform does not look like a sine wave. This is because you must change the radix setting from Hex to Signed Decimal, as described in the following subsection.

2. Right-click **U\_SINEGEN/sine[19:0]** signals, and select **Radix** → **Signed Decimal**.

You should now be able to see the high frequency sine wave as shown in the following figure instead of the square wave.

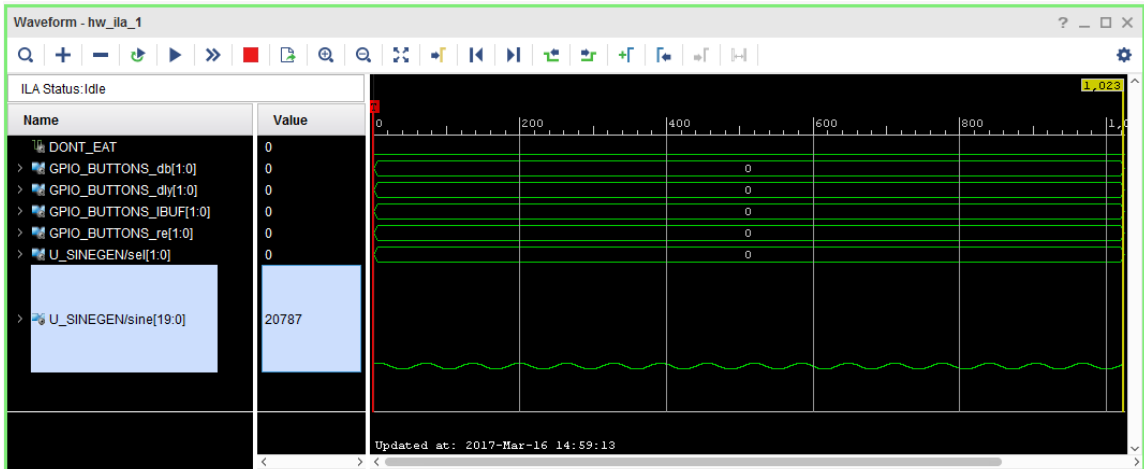

## Correcting Display of the Sine Wave

To view the mid, and low frequency output sine waves, perform the following steps:

1. Cycle the sine wave sequential circuit by pressing the GPIO\_SW\_E push button as shown in the following figure.

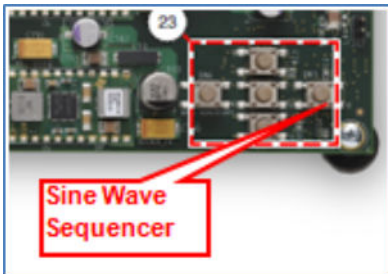

2. Click **Run Trigger Immediately** again to see the new sine selected sine wave. You should see the mid frequency as shown in the following figure. Notice that the `sel` signal also changed from 0 to 1 as expected.

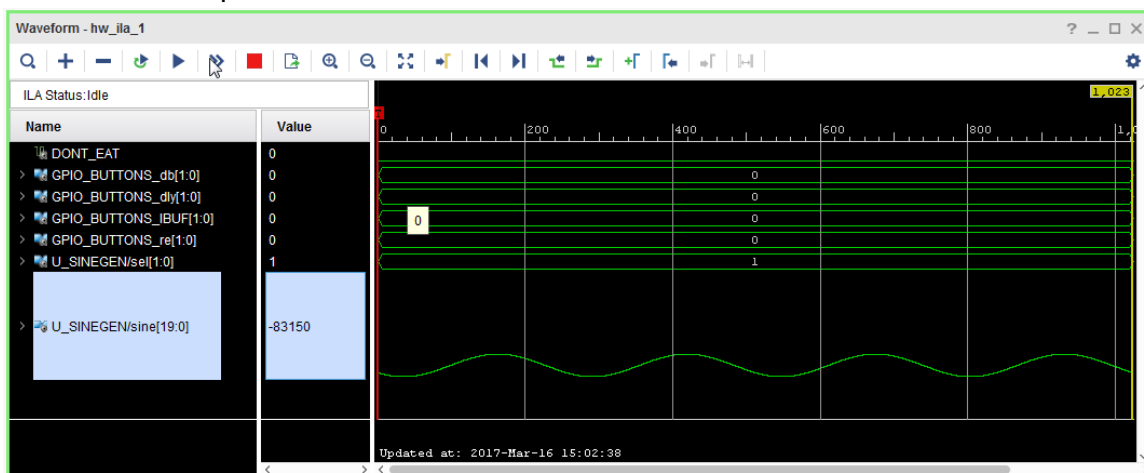

3. Repeat step 1 and 2 to view other sine wave outputs.



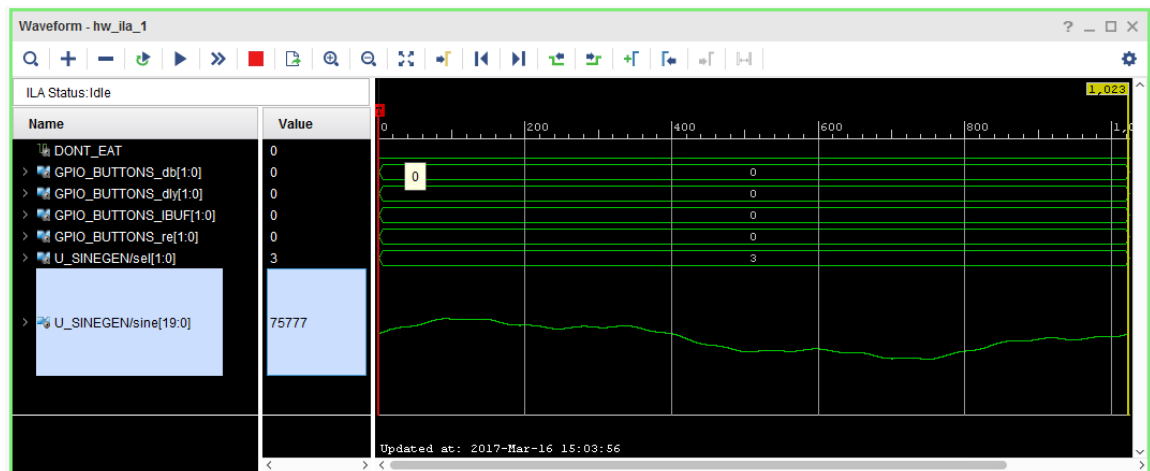
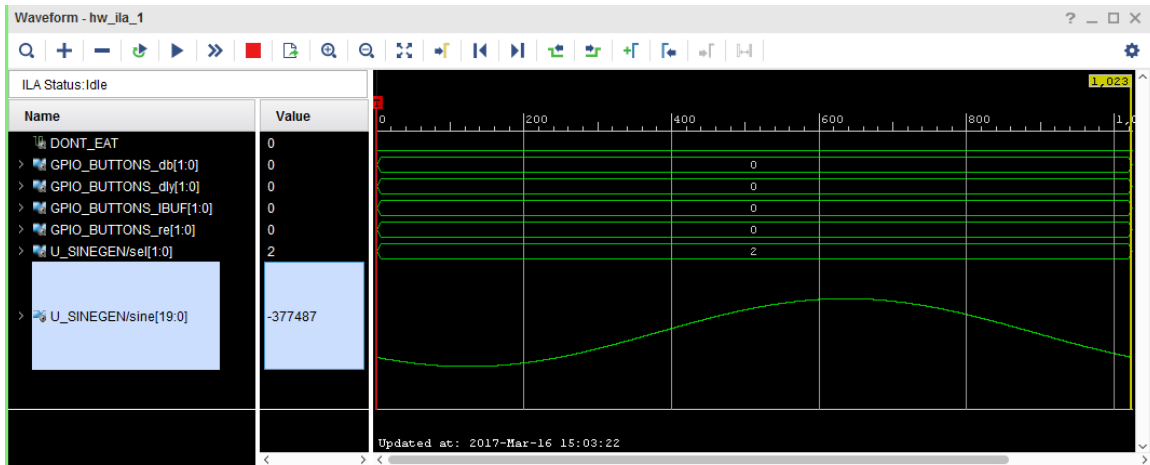

**Note:** As you sequence through the sine wave selections, you may notice that the LEDs do not light up in the expected order. You will debug this in the next section of this tutorial. For now, verify for each LED selection, that the correct sine wave displays. Also, note that the signals in the Waveform window have been re-arranged in the previous three figures.

## Step 2: Debugging the Sine Wave Sequencer State Machine (Optional)

As you corrected the sine wave display, the LEDs might not have lit up in sequence as you pressed the Sine Wave Sequencer button. With each push of the button, there should be a single, cycle-wide pulse on the `GPIO_BUTTONS_re[1]` signal. If there is more than one, the behavior of the LEDs becomes irregular. In this section of the tutorial, use Vivado logic analyzer to probe the sine wave sequencer state machine, and to view and repair the root cause of the problem.

Before starting the actual debug process, it is important to understand more about the sine wave sequencer state machine.

## Sine Wave Sequencer State Machine Overview

The sine wave sequencer state machine selects one of the four sine waves to be driven onto the sine signal at the top-level of the design. The state machine has one input and one output. The following figure shows the schematic elements of the state machine. Refer to this diagram as you read the following description and as you perform the steps to view and repair the state machine glitch.

- The input is a scalar signal called “button”. When the button input equals “1”, the state machine advances from one state to the next.
- The output is a 2-bit signal vector called “Y”, and it indicates which of the four sine wave generators is selected.

The input signal button connects to the top-level signal `GPIO_BUTTONS_re[1]`, which is a low-to-high transition indicator on the Sine Wave Sequencer button. The output signal Y connects to the top-level signal, `sineSel`, which selects the sine wave.

Figure 3: Sine Wave Sequence Button Schematic

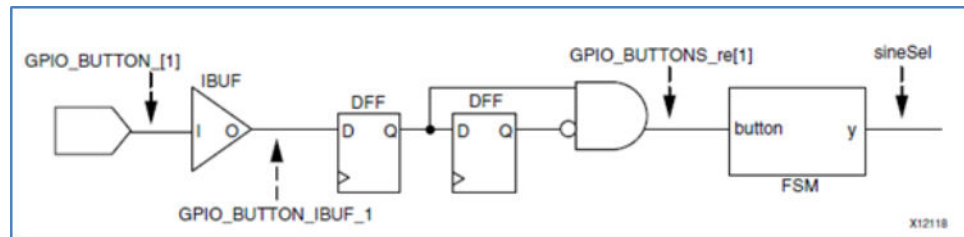

## Viewing the State Machine Glitch

You cannot troubleshoot the issue identified above by connecting a debug probe to the `GPIO_BUTTON [1]` input signal itself. The `GPIO_BUTTON [1]` input signal is a PAD signal that is not directly accessible from the FPGA fabric. Instead, you must trigger on low-to-high transitions (rising edges) on the `GPIO_BUTTON_IBUF` signal, which is connected to the output of the input buffer of the `GPIO_BUTTON [1]` input signal.

As described earlier, the glitch reveals itself as multiple low-to-high transitions on the `GPIO_BUTTONS_IBUF_1` signal, but it occurs intermittently. Because it could take several button presses to detect it, you will now set up the Vivado logic analyzer tool to Repetitive Trigger Run Mode. This setting makes it easier to repeat the button presses and look for the event in the Waveform viewer.

1. Under the Settings tab for `hw_ila_1`, configure the following:
  - Trigger Mode to `BASIC_ONLY`
  - Capture Mode to `BASIC`
  - Window Data Depth to 1024

- Trigger position to 512
- Press the + button in the Trigger Setup window and add probe GPIO\_BUTTONS\_IBUF\_1. Change the Value field to RX by selecting the value RX in the Value field, as shown in the following figure.

The figure shows three screenshots from the Vivado Logic Analyzer interface:

- Top Screenshot:** The 'Waveform - hw\_ila\_1' window. The left pane shows a list of signals with their current values:
 

Name	Value
DONT_EAT	0
GPIO_BUTTONS_db[1:0]	0
GPIO_BUTTONS_dly[1:0]	0
GPIO_BUTTONS_IBUF[1:0]	0
GPIO_BUTTONS_re[1:0]	0
U_SINEGEN/se[1:0]	3
U_SINEGEN/sine[19:0]	-183094

 The right pane shows a waveform with a red trigger marker at time 512.
- Middle Screenshot:** The 'Settings - hw\_ila\_1' window. The 'Trigger Mode Settings' section shows 'Trigger mode: BASIC\_ONLY'. The 'Capture Mode Settings' section shows 'Capture mode: ALWAYS', 'Number of windows: 1', 'Window data depth: 1024', and 'Trigger position in window: 512'. The 'General Settings' section shows 'Refresh rate: 500 ms'.
- Bottom Screenshot:** The 'Trigger Setup - hw\_ila\_1' window. A table shows the trigger configuration:
 

Name	Operator	Radix	Value	Port
GPIO_BUTTONS_IBUF[1:0]	==	[B]	RX	probe3[1:0]

 A dialog box is open over the 'Value' field, showing 'Value: RX' and 'Port: probe3[1:0]' with 'OK' and 'Cancel' buttons.



**CAUTION!** For different labs the GPIO\_BUTTONS\_IBUF might show up differently or have a different name such as button\_in4\_in. This might also show up as two individual bits or two bits lumped together in a bus. Ensure that you are using bit 1 of this bus to set up your trigger condition. For example in case of a two-bit bus, you will set the Value field in the Compare Value dialog box to RX.

2. Select **Enable Auto Re-trigger** mode on the ILA debug core as shown below.

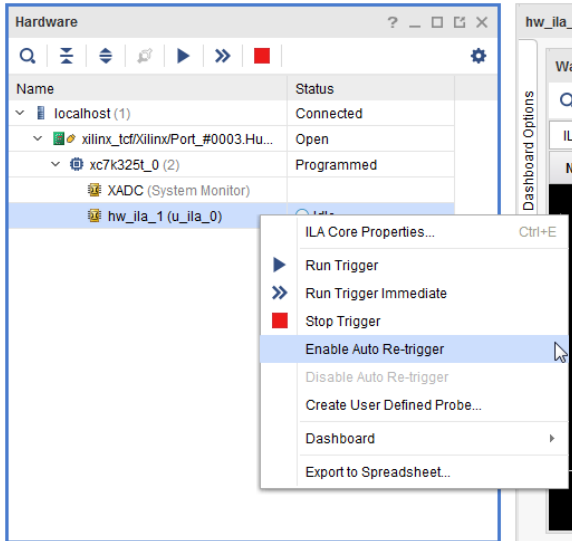

**CAUTION!** *The ILA properties window may look slightly different for different labs.*

When you issue a Run Trigger or a Run Trigger Immediate command after setting the Auto Retrigger mode, the ILA core does the following repetitively until you disable the Auto Retrigger mode option:

- Arms the trigger.
- Waits for the trigger.
- Uploads and displays waveforms.

3. On the KC705 board, press the Sine Wave Sequencer button until you see multiple transitions on the GPIO\_BUTTONS\_IBUF\_1 signal (this could take 10 or more tries). This is a visualization of the glitch that occurs on the input. An example of the glitch is shown in the following two figures.



**CAUTION!** *You may have to repeat the previous two steps repeatedly to see the glitch. After you can see the glitch, you may observe that the signal glitches are not at exactly the same location as shown in the figure below.*



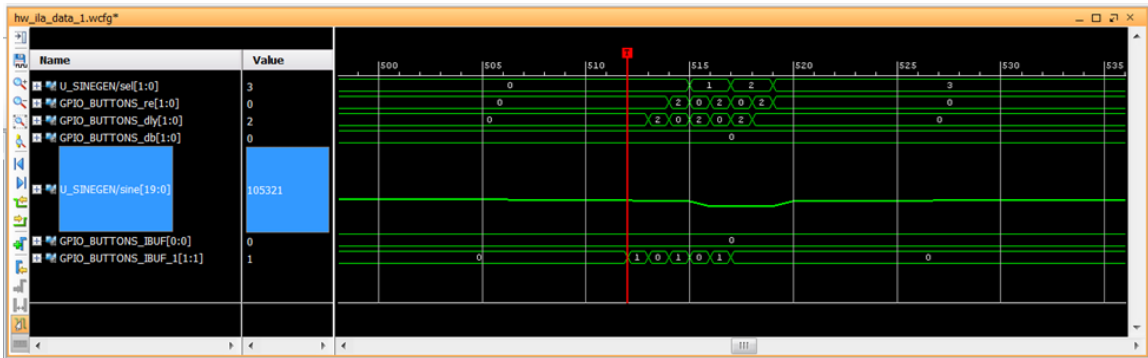

## Fixing the Signal Glitch and Verifying the Correct State Machine Behavior

The multiple transition glitch or “bounce” occurs because the mechanical button is making and breaking electrical contact just as you press it. To eliminate this signal bounce, a “de-bouncer” circuit is required.

1. Enable the de-bouncer circuit by setting DIP switch position on the KC705 board (labeled De-bounce Enable in [Figure 1](#)) to the ON or UP position.
2. Enable the Auto-Retrigger mode on the ILA debug core and click RunTrigger on the ILA core, and
  - Ensure that you no longer see multiple transitions on the GPIO\_BUTTON\_re[1] signal on a single press of the Sine Wave Sequencer button.
  - Verify that the state machine is working correctly by ensuring that the sineSel signal transitions from 00 to 01 to 10 to 11 and back to 00 with each successive button press.

## Verifying the VIO Core Activity (Only Applicable to Lab 3)

1. From the Program and Debug section in Flow Navigator, click **Open Hardware Manager**.

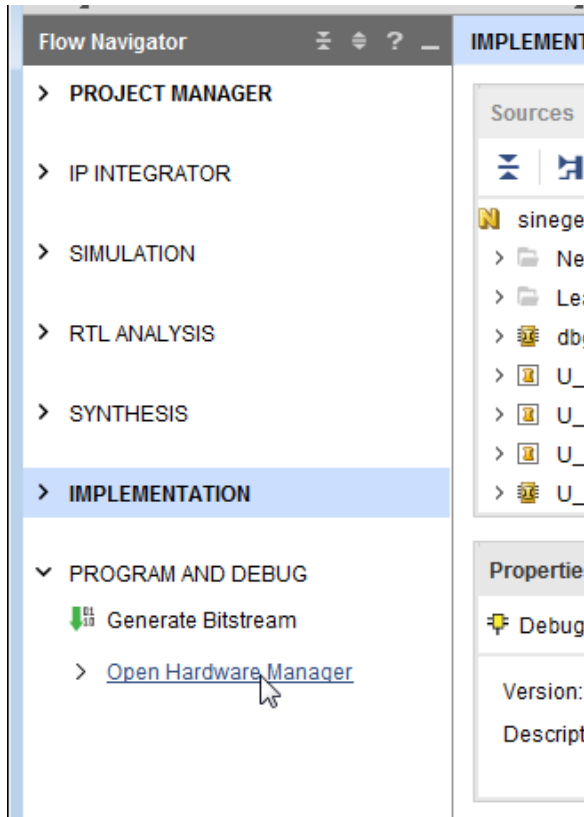

The Hardware Manager window opens.

2. Click **Open a new hardware target**.

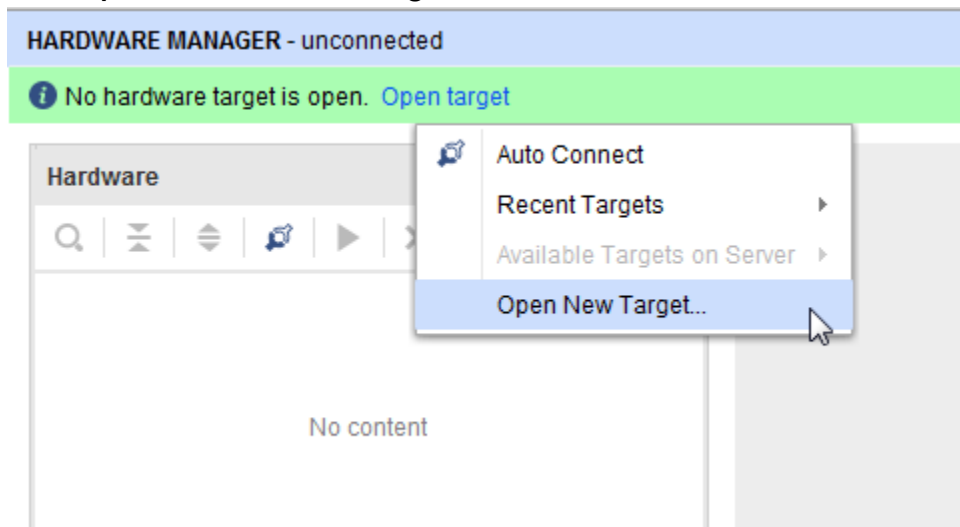

3. The Open New Hardware Target wizard opens. Click **Next**.
4. In the Hardware Server Settings page, type the name of the server (or select **Local server** if the target is on the local machine) in the Connect to field.

5. Ensure that you are connected to the right target by selecting the target from the Hardware Targets page. If there is only one target, that target is selected by default. Click **Next**.
6. In the Set Hardware Target Properties page, click **Next**.
7. In the Open Hardware Target Summary page, verify that all the information is correct, and click **Finish**.
8. Program the device by selecting and right-clicking the device in the Sources window and then selecting **Program Device**.

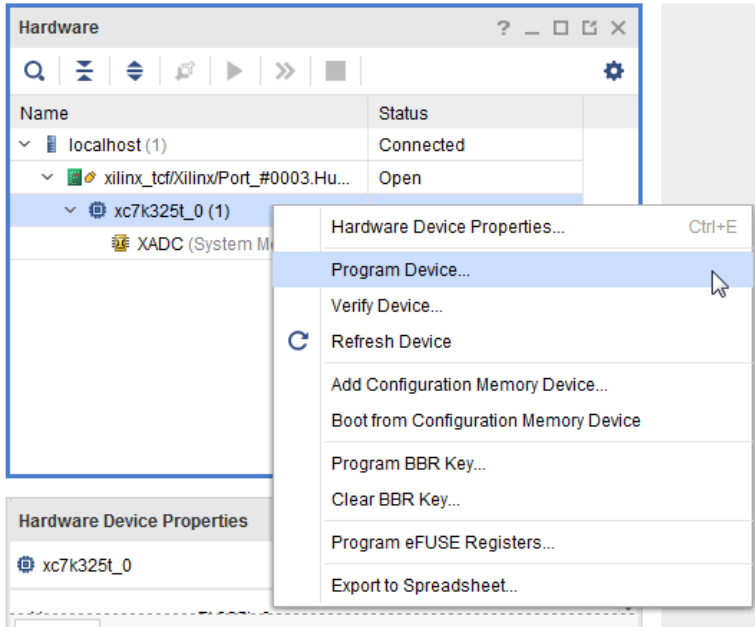

9. In the Program Device dialog box, ensure that the bit file to be programmed is correct. Click **OK**.

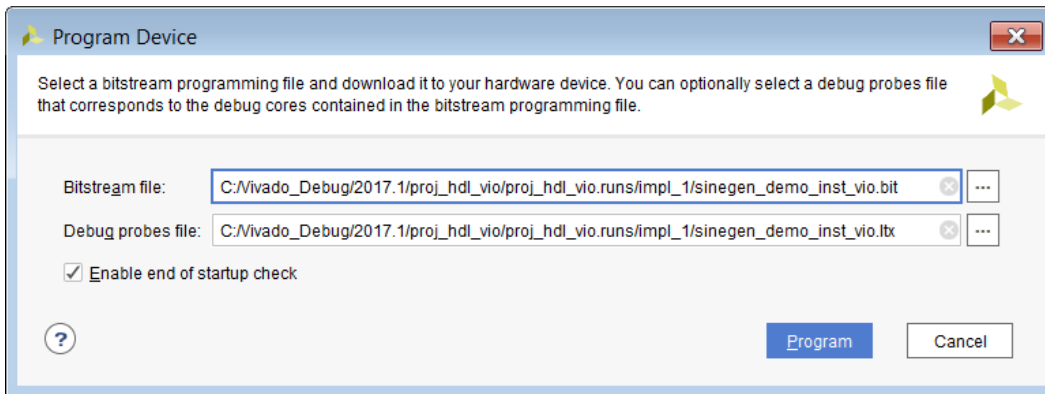

10. After the FPGA device is programmed, you see the VIO and the ILA core in the Hardware window.

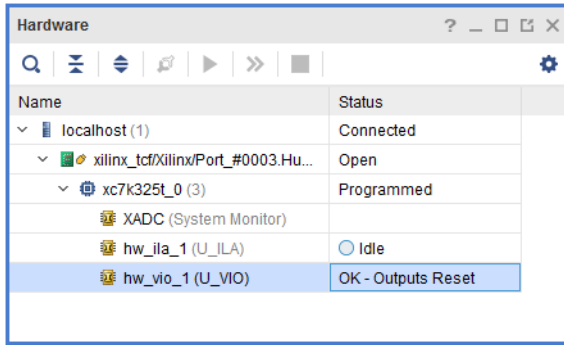

You now have a debug dashboard for the ILA core as shown in the following figure.

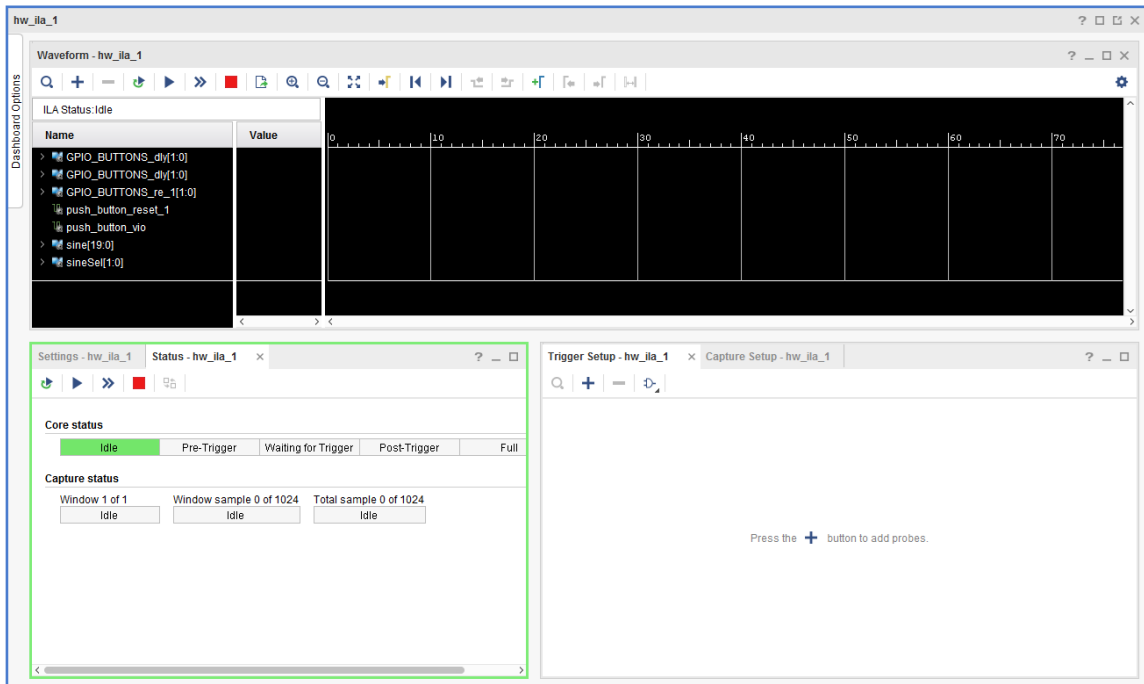

11. Click **Run Trigger Immediate** to capture the data immediately.



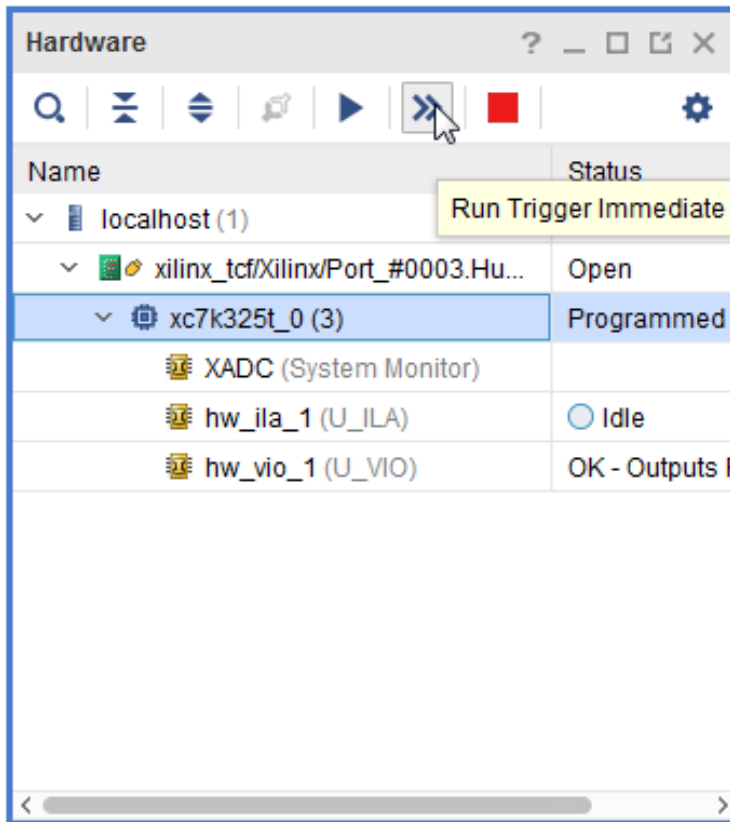

12. Make sure that there is activity on the sine [19:0] signal.
13. Select the sine signal in the Waveform window, right-click and select **Waveform Style** → **Analog**.
14. Select the sine signal in the Waveform window again, right-click and select **Radix** → **Signed Decimal**. You should be able to see the sine wave in the Waveform window.

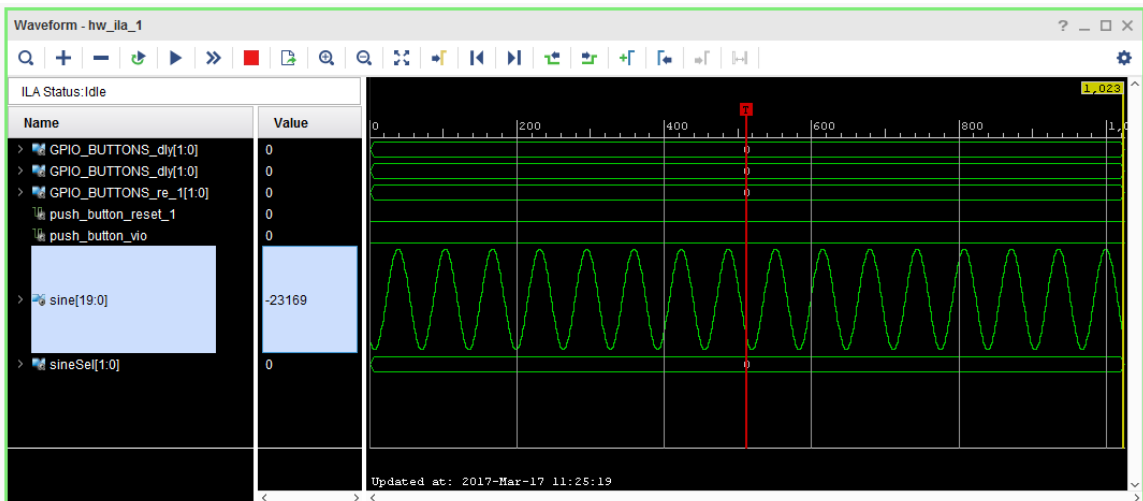

15. Instead of using the GPIO\_SW push button to cycle through each different sine wave output frequency, you are going to use the virtual “push\_button\_vio” toggle switch from the VIO core.
16. You can now customize the ILA dashboard options to include the VIO window. This allows you to toggle the VIO output drivers and observe the impact on the ILA waveform window all in one dashboard. Slide out the Dashboard Options window.

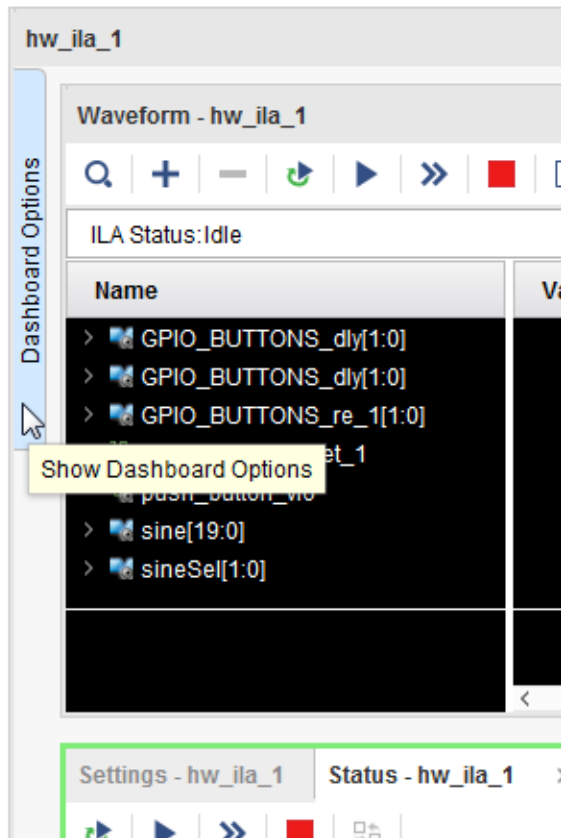

17. Add the VIO window to the ILA dashboard by selecting **hw\_vio\_1**.

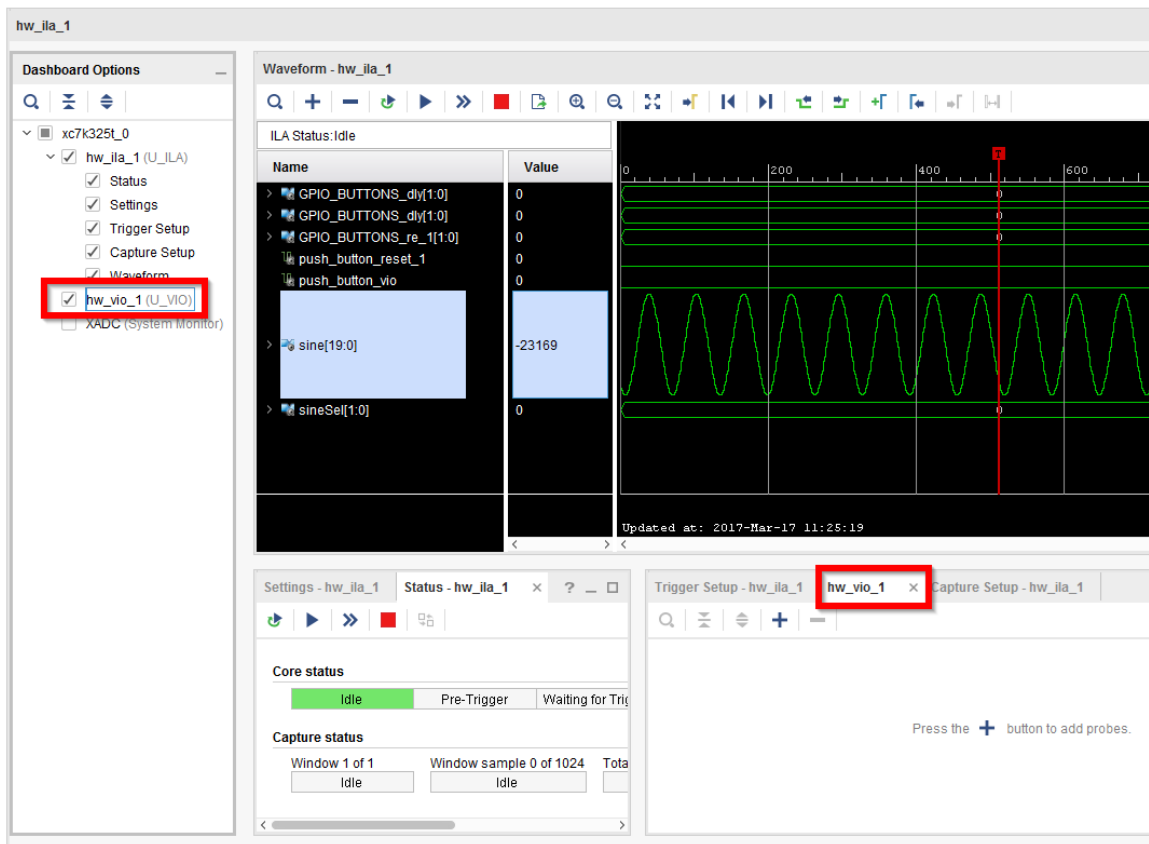

**Note:** The ILA dashboard now contains the VIO window as well.

- Adjust the Trigger Setup – hw\_ila\_1 window and the hw\_vio\_1 window so that they are side by side as shown in the following figure.

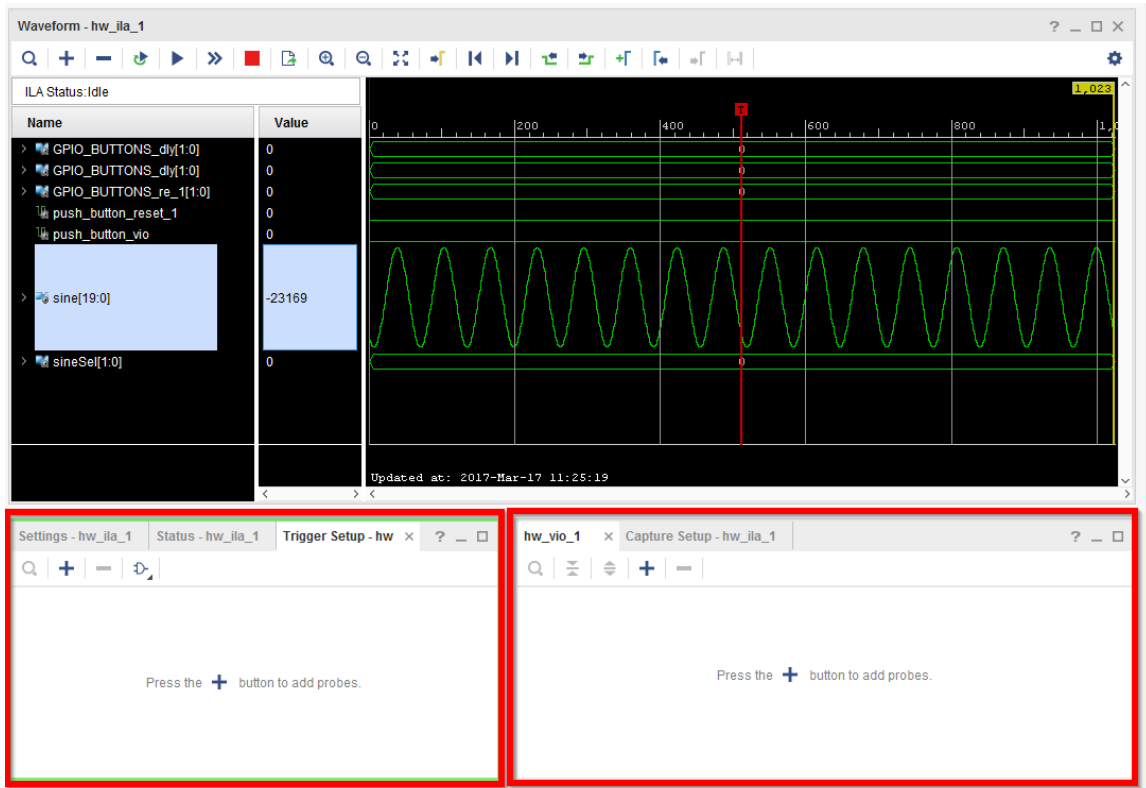

19. In the hw\_vio\_1 window, select the “+” button, and select all the probes under hw\_vio\_1.
20. Click OK.

**Note:** The initial values of all the probes.

The screenshot displays the Vivado Logic Analyzer interface. The top window, titled "Waveform - hw\_ila\_1", shows a list of signals on the left and a corresponding waveform on the right. The signals listed include GPIO\_BUTTONS\_dly[1:0], GPIO\_BUTTONS\_re\_1[1:0], push\_button\_reset\_1, push\_button\_vio, sine[19:0], and sineSel[1:0]. The waveform shows a periodic signal for sine[19:0] and zero values for the other signals. A red vertical cursor is positioned at approximately 450 on the time axis.

Below the waveform, there are several panels: "Settings - hw\_ila\_1", "Status - hw\_ila\_1", "Trigger Setup - hw\_ila\_1", and "hw\_vio\_1 x Capture Setup - hw\_ila\_1". The "hw\_vio\_1" panel shows a list of probes for hw\_vio\_1 (5) including DONT\_EAT, GPIO\_BUTTONS\_re[1:1], push\_button\_reset, push\_button\_vio\_1, and sineSel\_1[1:0].

At the bottom, there is a terminal window with the following text:

```

ILA_NAME="--U_ILA"
:s xc7k325t_0] -filter {CELL_NAME=="U_ILA"}
i:19
./proj_hdl_vio/proj_hdl_vio.hw/backup/hw_ila_data_1.ila. Use Tcl command 'import_hw_ila_da
  
```

21. Note the values on all probes in the hw\_vio\_1 window.

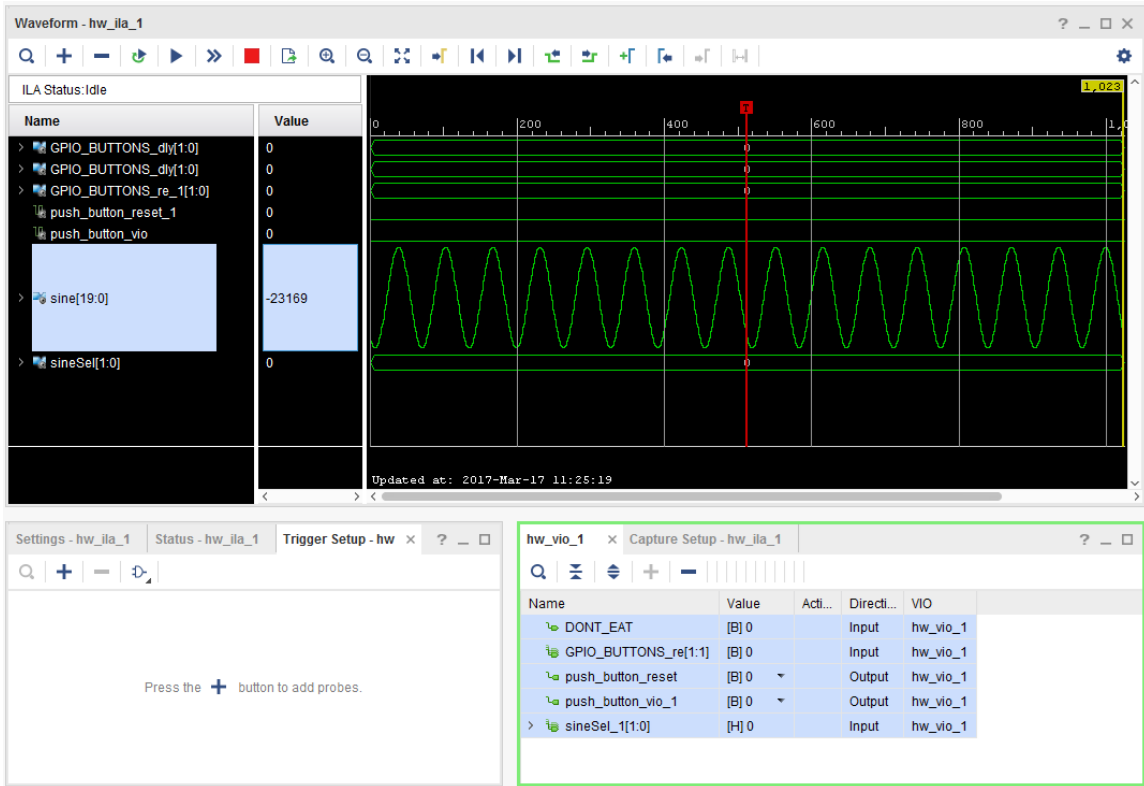

22. Set the push\_button\_reset output probe by right-clicking **push\_button\_reset** and select **Toggle Button**.

This will toggle the output driver from logic from 0 to 1 to 0 as you click. It is similar to the actual push button behavior, though there is no bouncing mechanical effect as with a real push button switch.

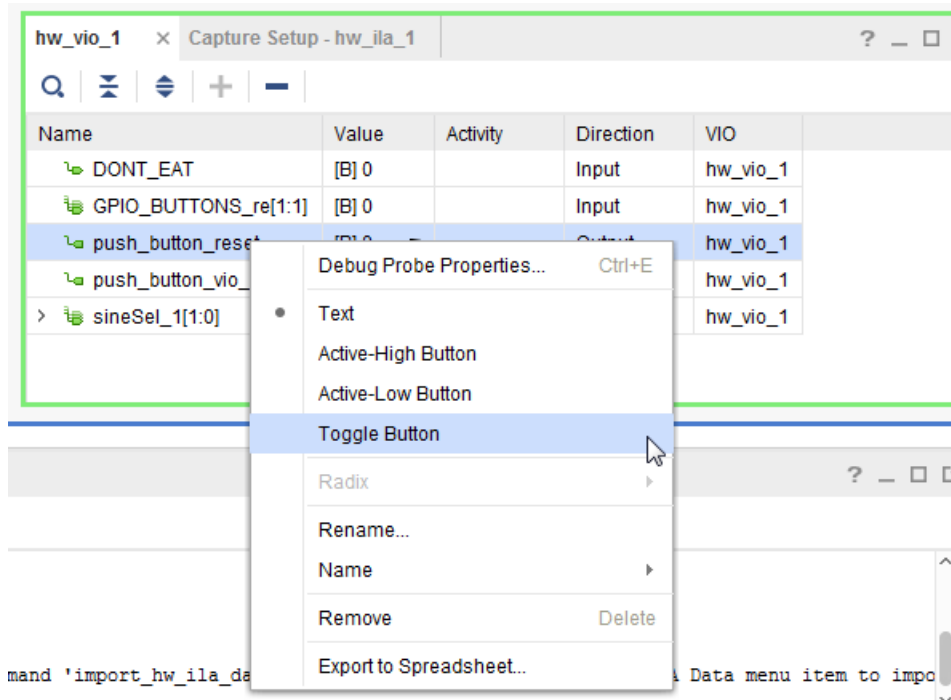

The Value field for push\_button\_reset is highlighted.

23. Click in the **Value** field to change its value to 1.

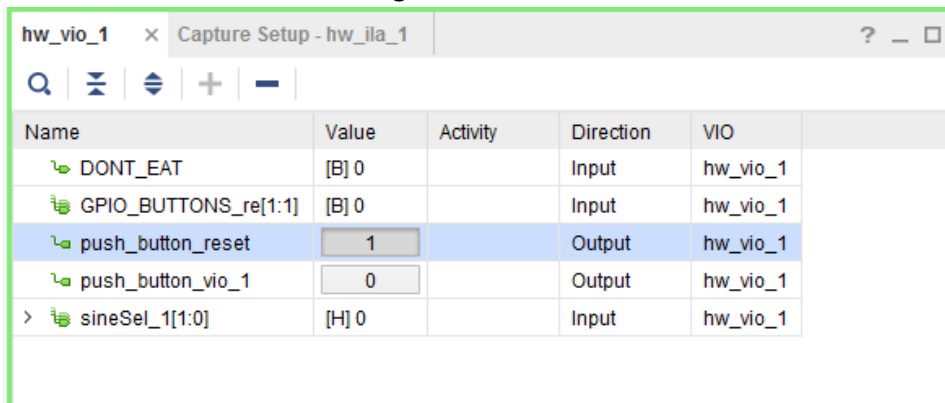

24. Follow the step above to change the push\_button\_vio to Toggle button as well.
25. Set these two bits of the “sineSel” input probe by right-clicking **PROBE\_IN0[0]** and **PROBE\_IN0[1]** and selecting **LED**.

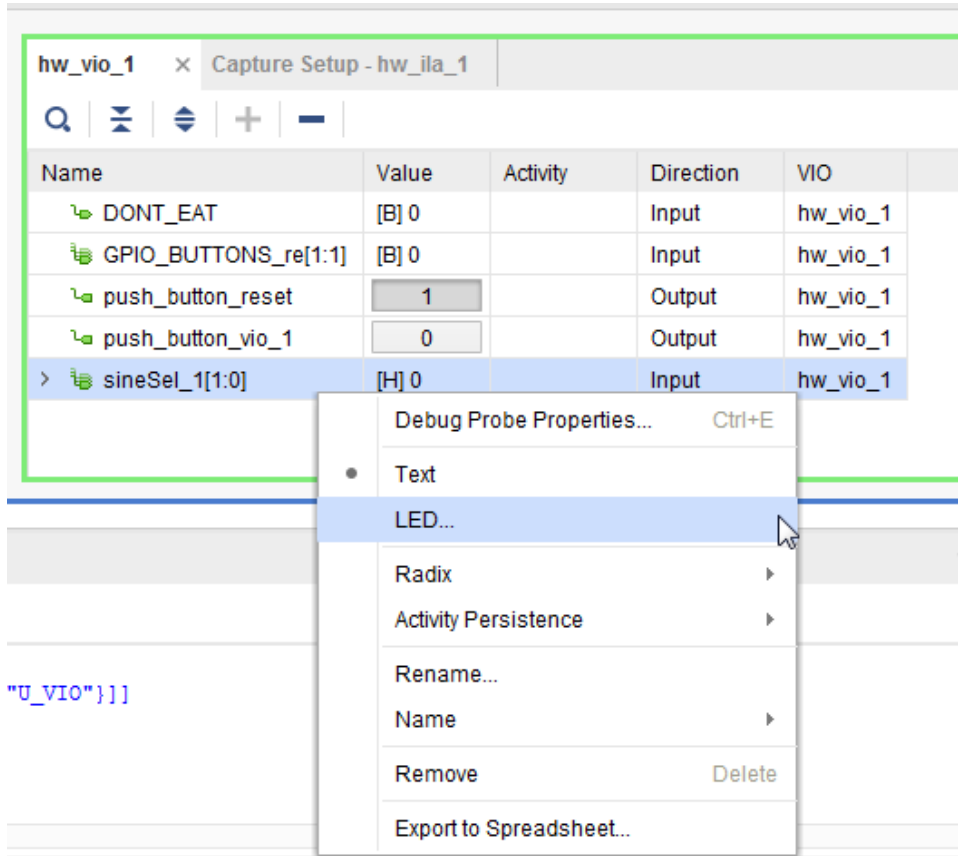

26. In the Select LED Colors dialog box, pick the **Low Value Color** and the High Value Color of the LEDs as you desire and click **OK**.

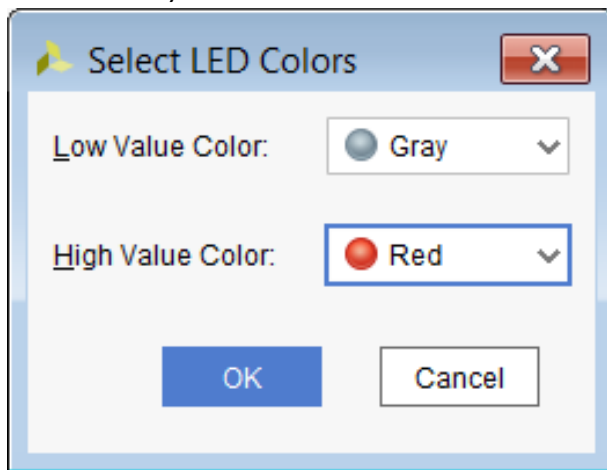

27. When finished, your VIO Probes window in the Hardware Manager should look similar to the following figure.



Name	Value	Activity	Direction	VIO
DONT_EAT	[B] 0		Input	hw_vio_1
GPIO_BUTTONS_re[1:1]	[B] 0		Input	hw_vio_1
push_button_reset	1		Output	hw_vio_1
push_button_vio_1	0		Output	hw_vio_1
sineSel_1[1:0]	[H] 0		Input	hw_vio_1

28. To cycle through each different sine wave output frequency using the virtual “push\_button\_vio” from the VIO core, perform the following simple steps:

- a. Toggle the value of the “push\_button\_vio” output driver from 0 to 1 to 0 by clicking on the logic displayed under the Value column. You will notice the sineSel LEDs changed accordingly – 0, 1, 2, 3, 0, etc...

Name	Value	Activity	Direction	VIO
DONT_EAT	[B] 0		Input	hw_vio_1
GPIO_BUTTONS_re[1:1]	[B] 0		Input	hw_vio_1
push_button_reset	0		Output	hw_vio_1
sineSel_1[1:0]	[H] 1		Input	hw_vio_1
sineSel_1[1]			Input	hw_vio_1
sineSel_1[0]			Input	hw_vio_1
push_button_vio_1	1		Output	hw_vio_1

- b. Click **Run Trigger** for hw\_ila\_1 to capture and display the selected sine wave signal from the previous step.

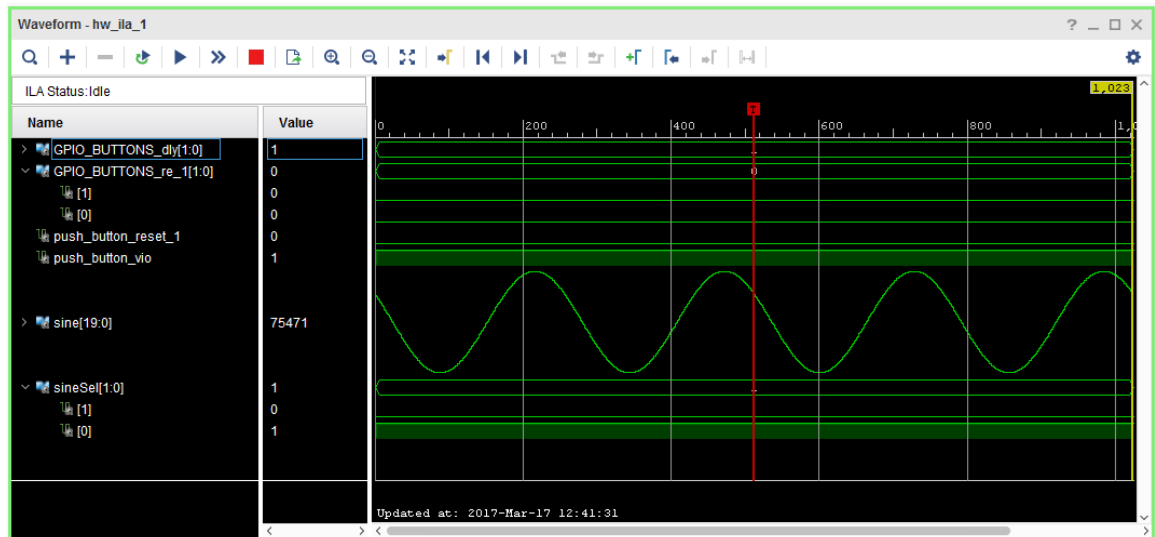

# Using the ECO Flow to Replace Debug Probes Post Implementation

This simple tutorial shows you how to replace nets connected to an ILA core in a placed and routed design checkpoint using the Vivado® Design Suite Engineering Change Order (ECO) flow.

**Note:** To learn more about using the ECO flow, refer to the *Debugging Designs Post Implementation* chapter in the *Vivado Design Suite User Guide: Programming and Debugging (UG908)*.

1. Open the Vivado® Design Suite, and select **File → Open Checkpoint**.

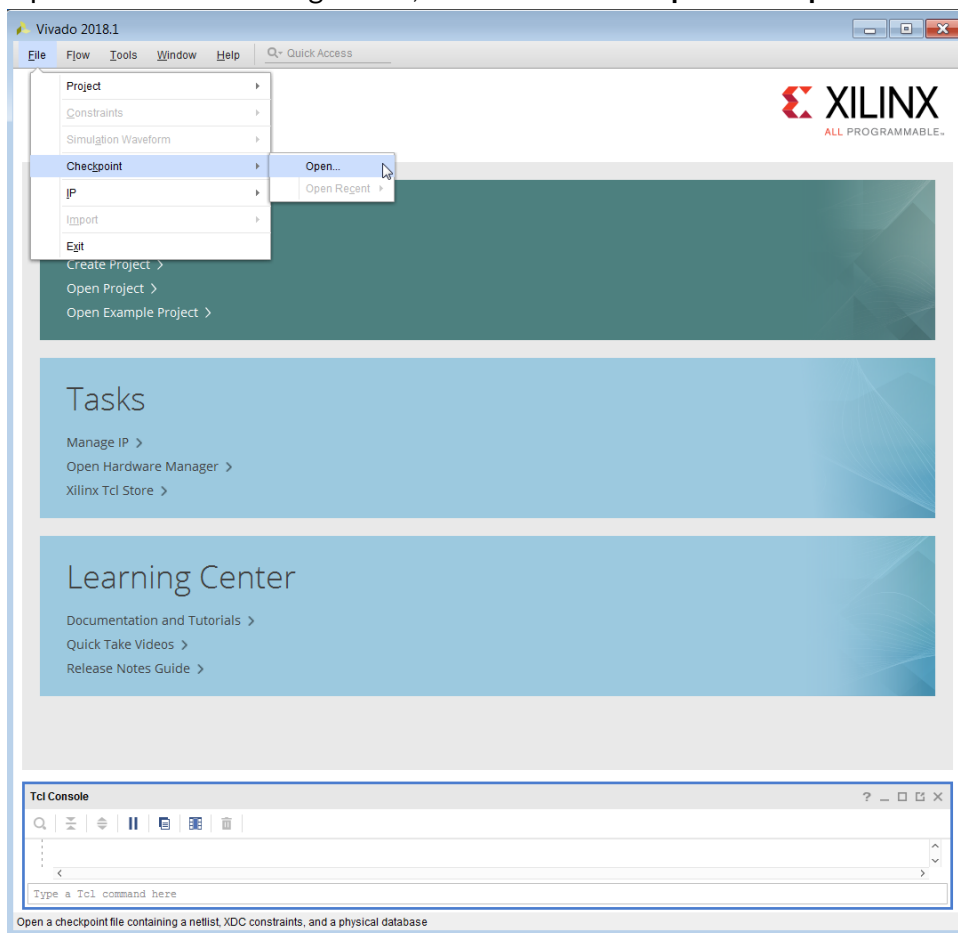

2. Open the routed checkpoint that you created in [Lab 2: Using the HDL Instantiation Method to Debug a Design](#).

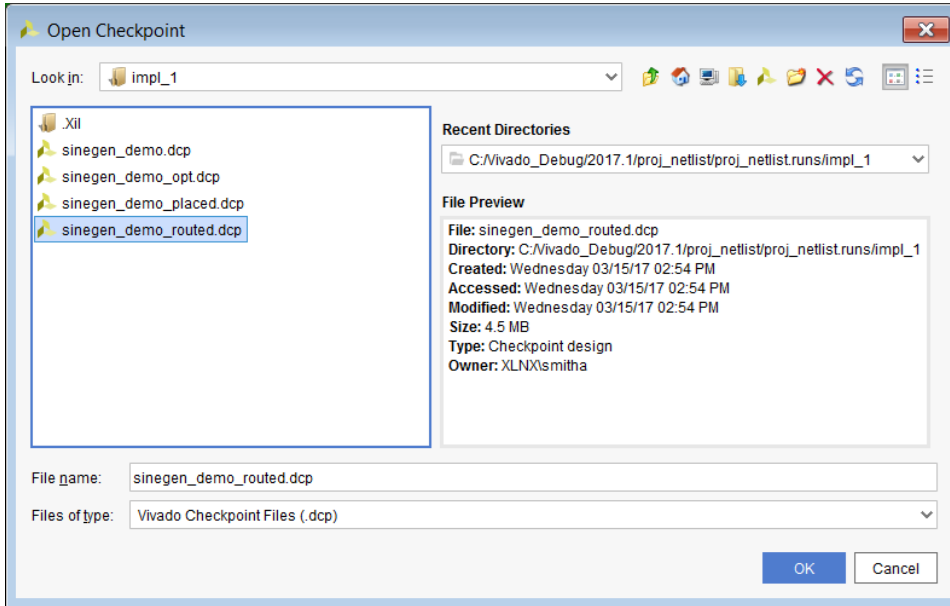

Change the layout in the Vivado Design Suite toolbar drop-down to ECO.

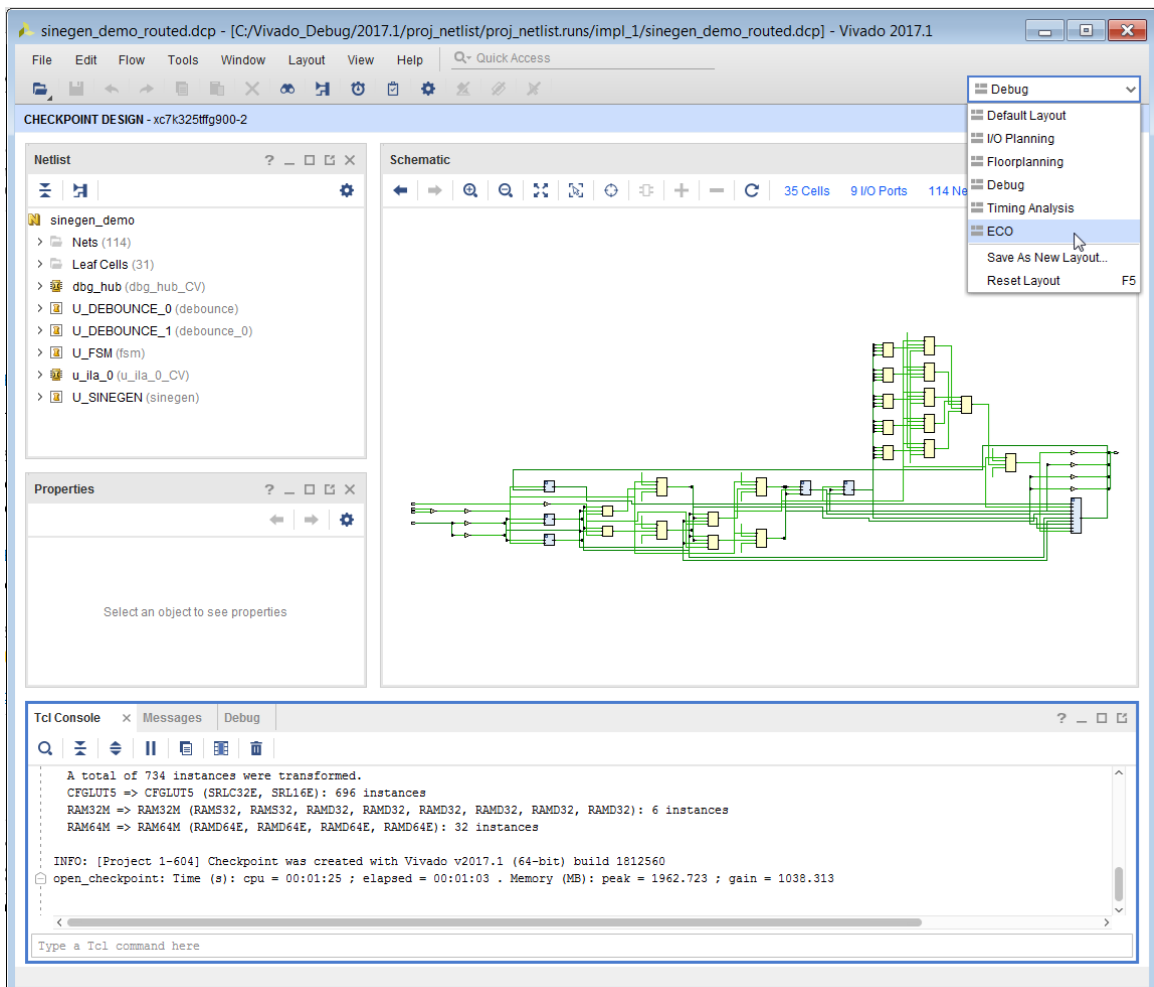

**Note:** The Flow Navigator window now changes to ECO Navigator with a different set of options.

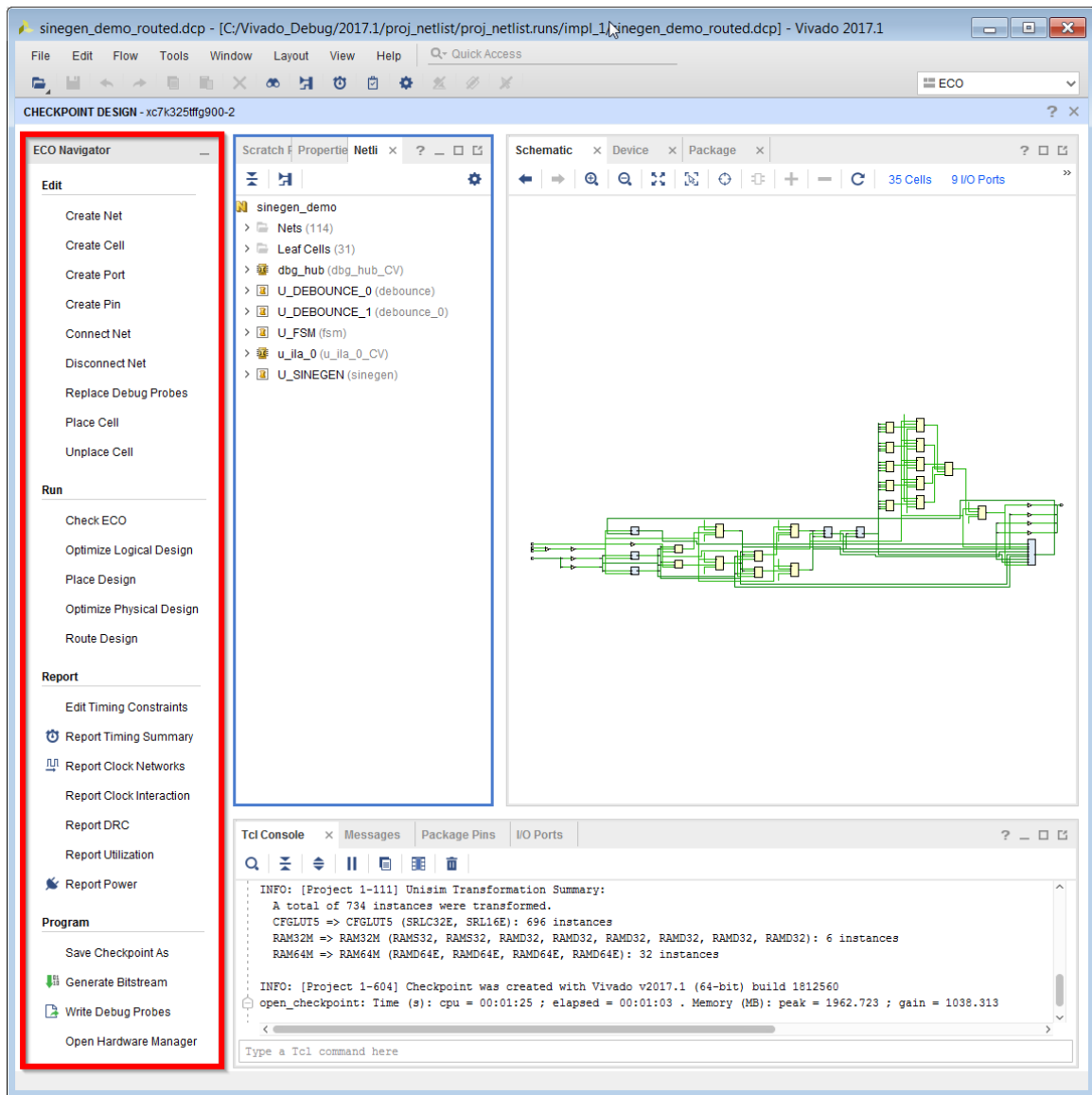

3. In the ECO Navigator window, click **Replace Debug Probes** to bring up the Replace Debug Probes dialog box. Note the Debug Hub and ILA cores in the design.

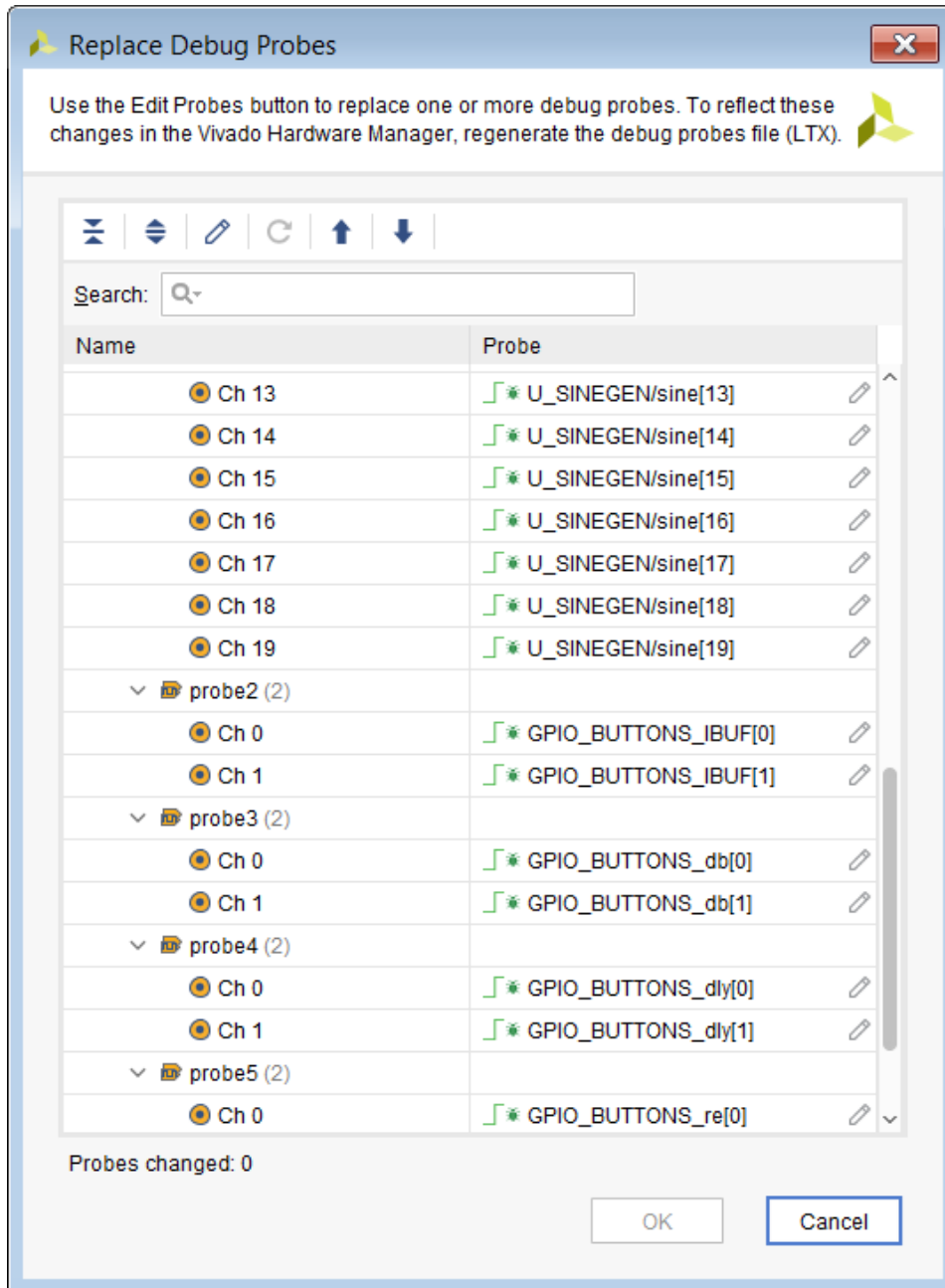

**IMPORTANT!** Xilinx strongly recommends that you do not replace the clock nets associated with ILA and Debug Hub cores.

- In the Replace Debug Probes dialog box, highlight the probes whose nets you want to change. In this lab you will replace the GPIO\_BUTTONS\_dly[0] net that is being probed.
- Click the **Edit Probes** button to the right of the GPIO\_BUTTONS\_dly[0] probe net to bring up the Choose Nets dialog box.

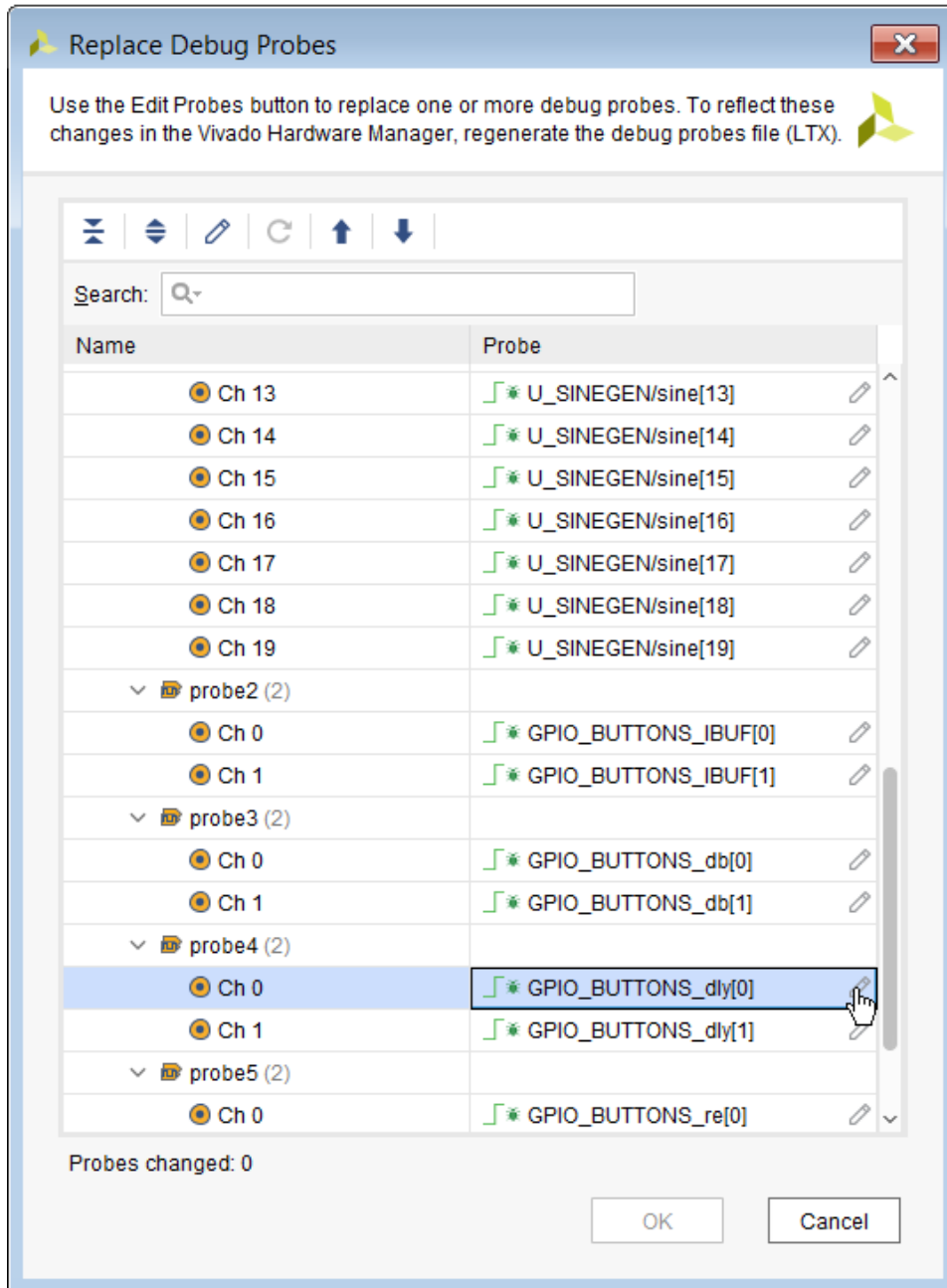

- In the Choose Nets dialog box, choose the U\_DEBOUNCE\_0/clear net to replace the existing GPIO\_BUTTONS\_dly[0] probe net. Click **OK**.

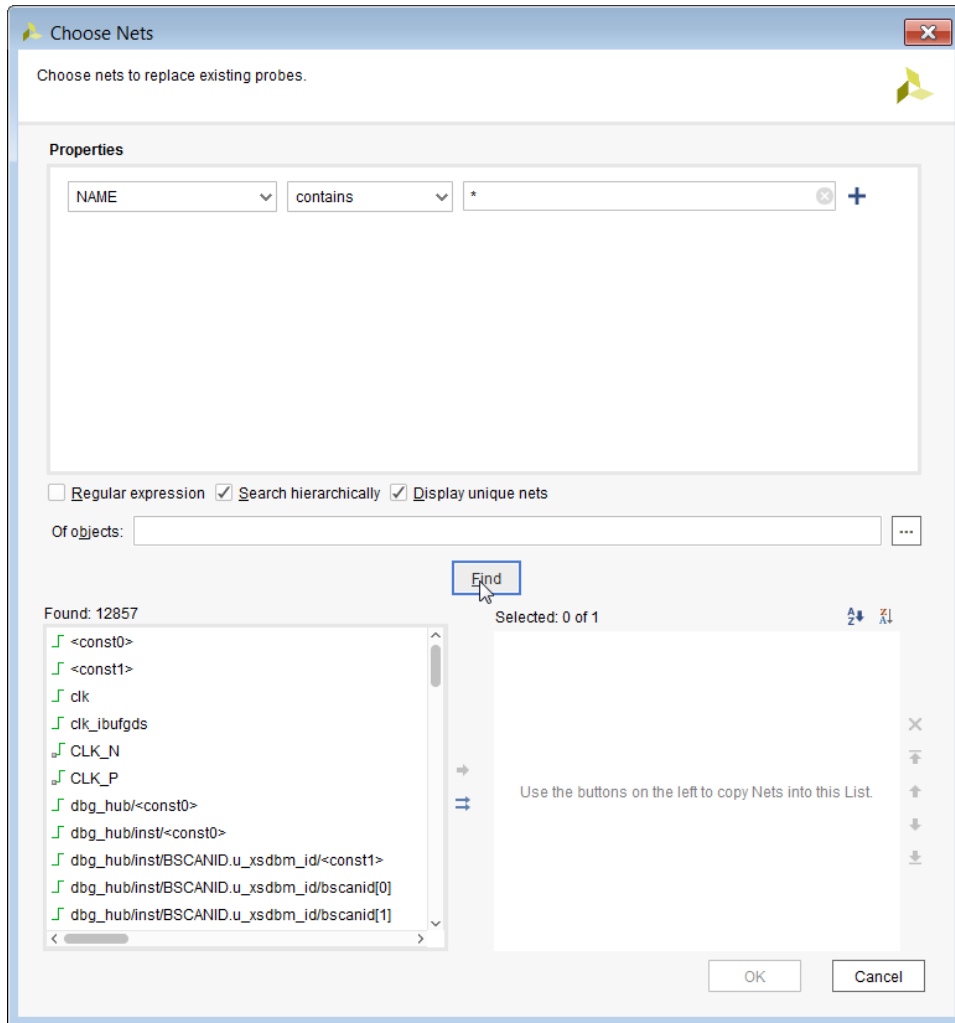

7. Type for “\*clear net” in the Name field and Click **Find**. Notice the **U\_DEBOUNCE\_0** net in the Found nets area. Select **U\_DEBOUNCE\_0/clear net** using the “->” arrow and click **OK**. The U\_DEBOUNCE\_0/clear net to replaces the existing GPIO\_BUTTONS\_dly[0] probe net.



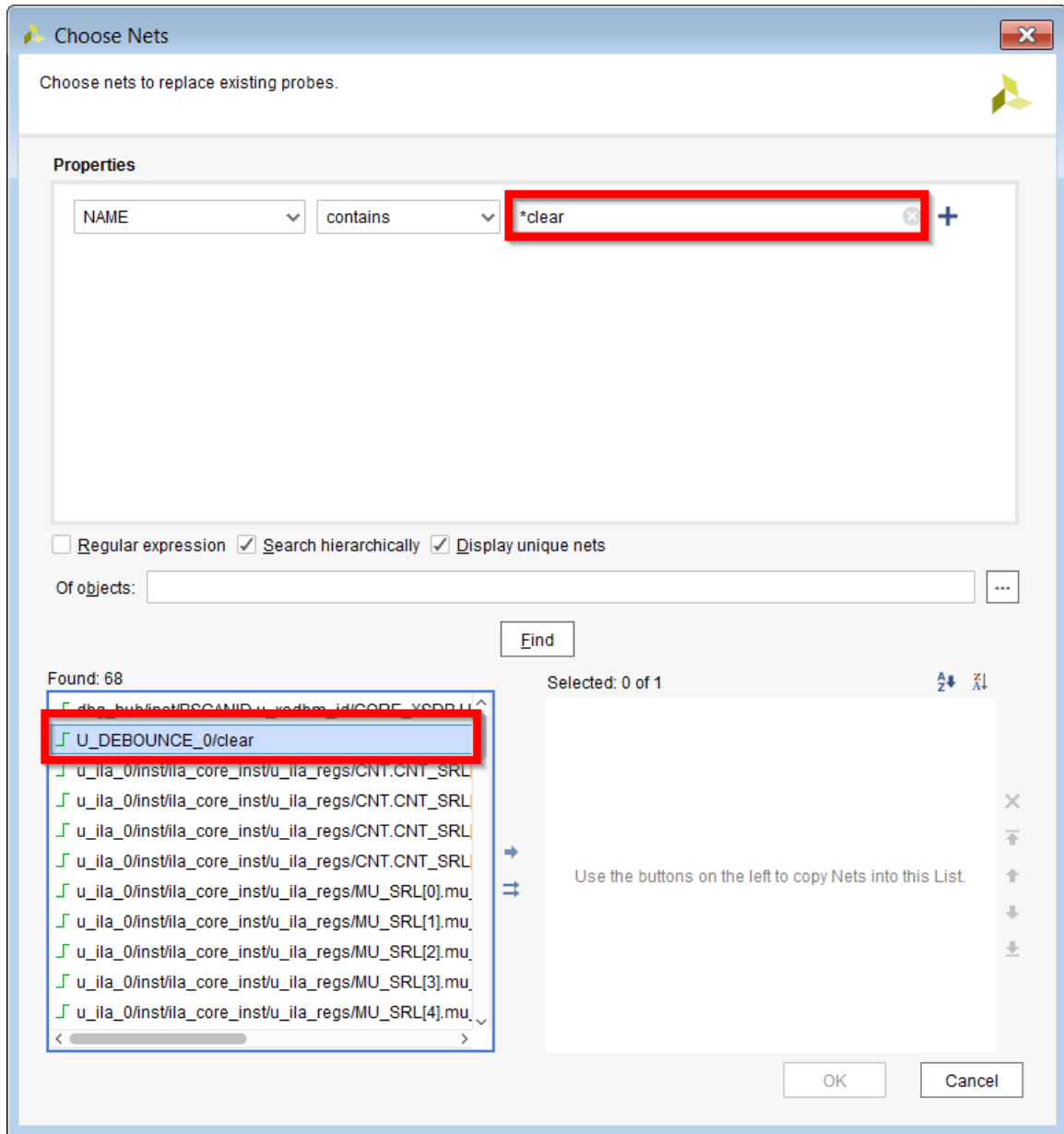

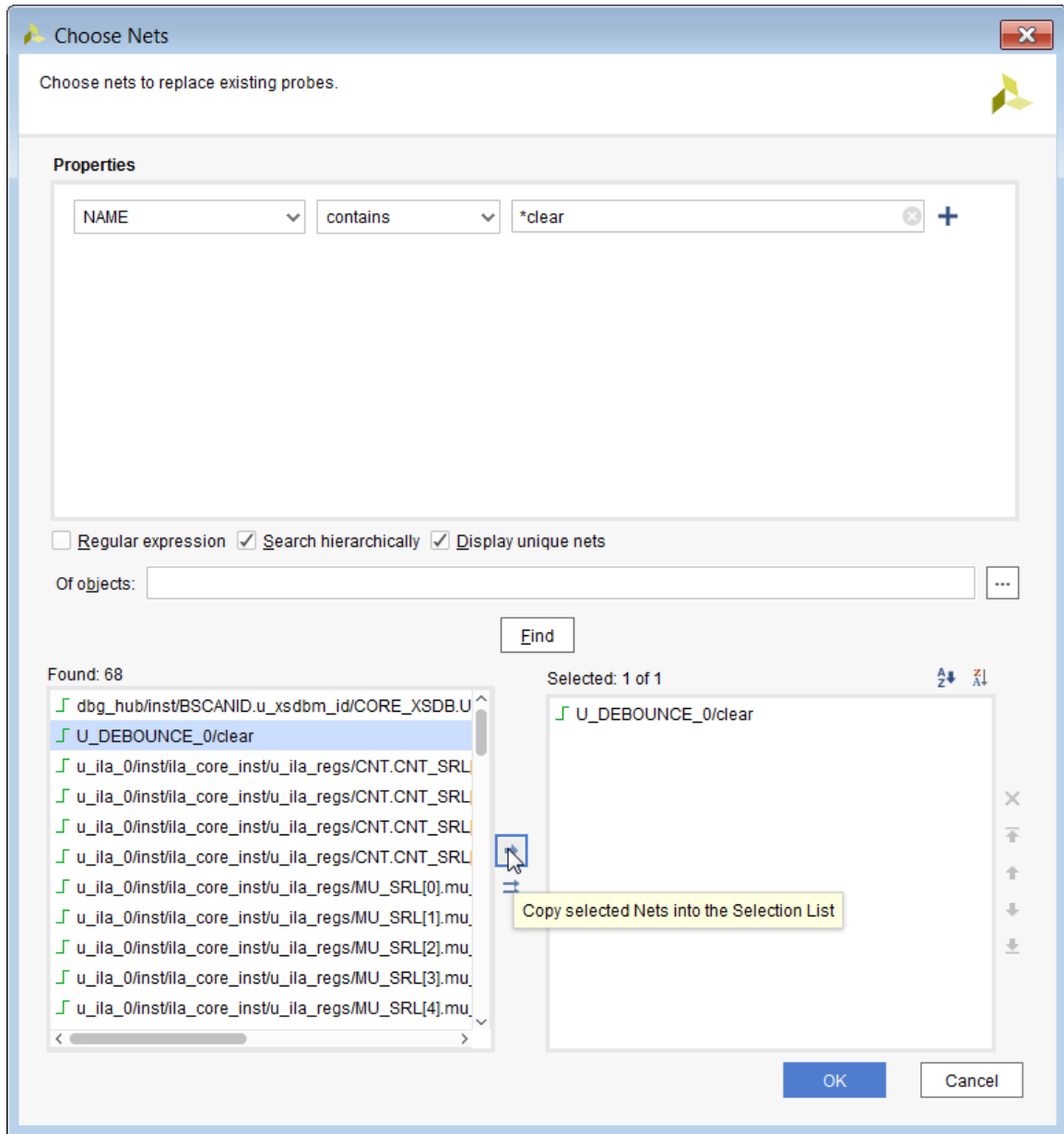

8. Now click **OK** in the Replace Debug Probes dialog. An additional dialog box may appear if the nets were marked with DONT\_TOUCH indicating that it must be removed to proceed. If so, click **Unset Property and Continue**.

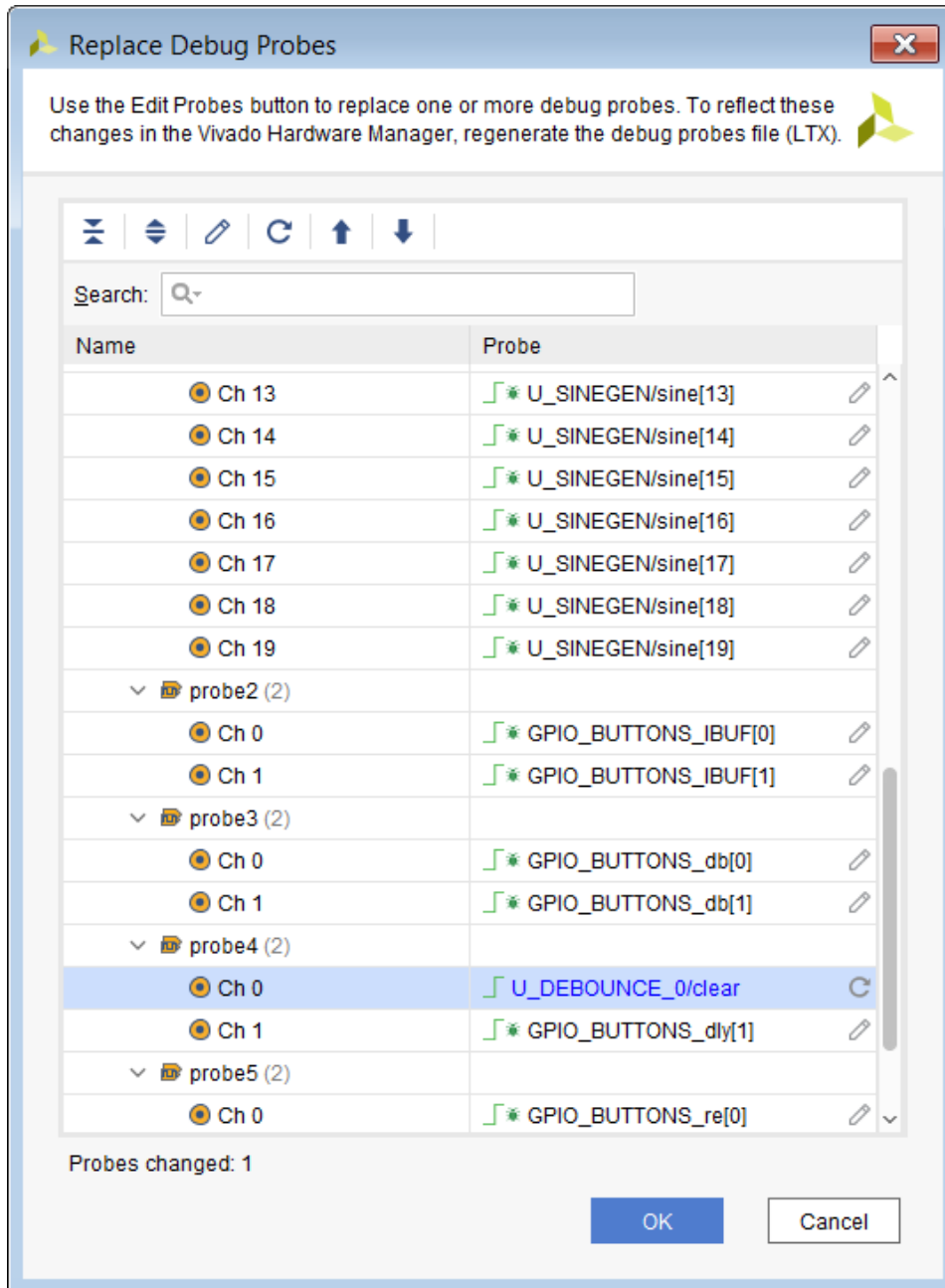

**★ IMPORTANT!** Check the Tcl Console to ensure that there are no Warnings/Errors.

```

Tcl Console x Messages Debug Package Pins I/O Ports
[Icons]
show_objects -name NET_ONLY [get_nets -hierarchical -top_net_of_hierarchical_group "*" ]
show_objects -name NET_ONLY [get_nets -hierarchical -top_net_of_hierarchical_group "*clear*" ]
modify_debug_ports -probes [list {u_ila_0/probel 0 U_DEBOUNCE_0/clear}]
Netlist sorting complete. Time (s): cpu = 00:00:00 ; elapsed = 00:00:00.028 . Memory (MB): peak = 2884.758 ; gain = 0.000
INFO: [Vivado_Tcl 4-963] Removed DONT_TOUCH property on net U_SINEGEN/sine[0] to prepare for debug probe changes.
INFO: [Vivado 12-3773] the DONT_TOUCH property on this net is implied by a MARK_DEBUG. Setting the DONT_TOUCH property to FALSE or 0 will enabl
Starting Physical Synthesis Task
Phase 1 Physical Synthesis Initialization
INFO: [Physopt 32-721] Multithreading enabled for phys_opt_design using a maximum of 2 CPUs
INFO: [Physopt 32-668] Current Timing Summary | WNS=0.594 | TNS=0.000 | WHS=0.060 | THS=0.000 |
Phase 1 Physical Synthesis Initialization | Checksum: 1f020a08d

```

```

Tcl Console x Messages Debug Package Pins I/O Ports
[Icons]
-----
INFO: [Common 17-83] Releasing license: Implementation
12 Infos, 0 Warnings, 0 Critical Warnings and 0 Errors encountered.
route_design completed successfully
route_design: Time (s): cpu = 00:01:33 ; elapsed = 00:01:44 . Memory (MB): peak = 2239.453 ; gain = 225.266
Type a Tcl command here

```

- Save your modifications to a new checkpoint. Use the Save Checkpoint As option in the ECO Navigator to bring up the Save Checkpoint As dialog box. Specify a file name for the .dcp file and click **OK**.

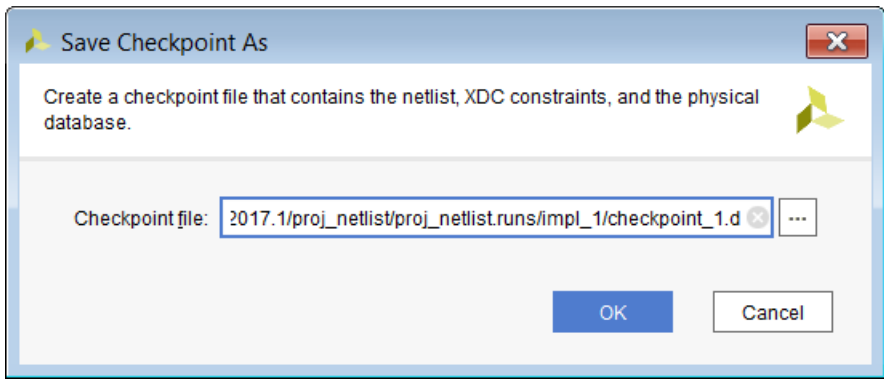

- Click **Write Debug Probes** in the ECO Navigator. When the Write Debug Probes dialog appears, click **OK** to generate a new .ltx file for the debug probes.

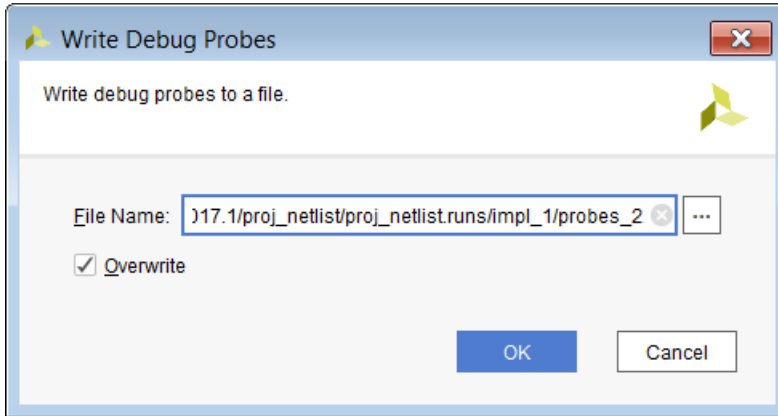

11. Click **Generate Bitstream** in the ECO navigator. When the Generate Bitstream dialog appears, change the bit file name to `project_sinegen_demo_routed_debug_changes.bit` in the Bit File field and click **OK** to generate a new `.bit` file that reflects the debug probe changes.

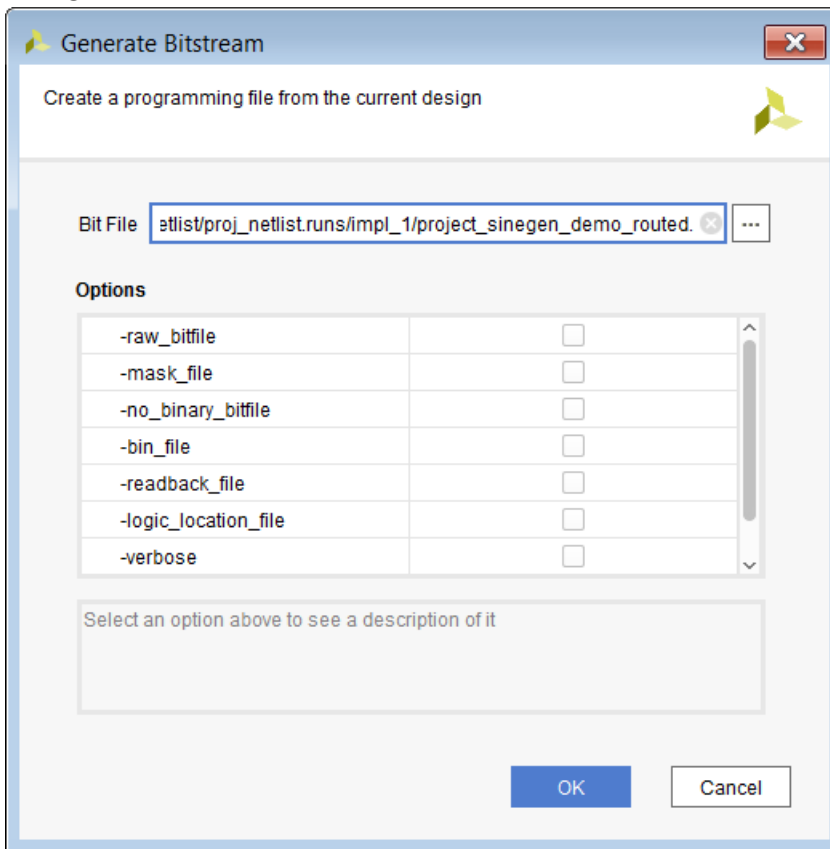

12. Connect to the Vivado Hardware Manager by selecting Open Hardware Manager in the ECO Navigator.
13. Connect to the local hardware server by following the steps in the Target Board and Server Set Up section in [Lab 5: Using the Vivado Logic Analyzer to Debug Hardware](#).

Program the device using the `.bit` file and `.ltx` files that you created in the previous steps.

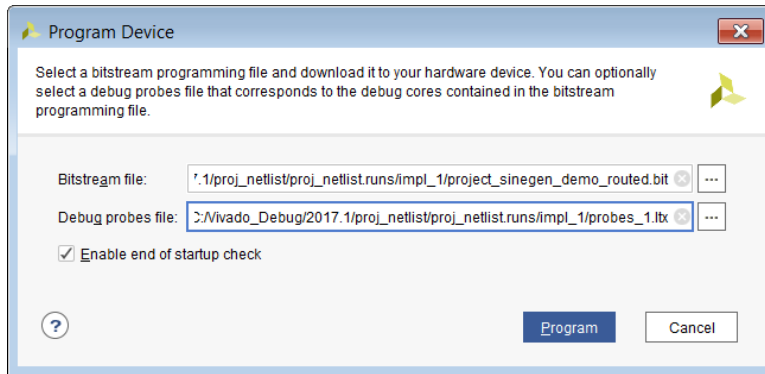

14. Select **Window** → **Debug Probes** from the Vivado Design Suite toolbar. Ensure that the probes that were replaced in step 8 and 9 above are reflected in the probes associated with `hw_ila_1`.

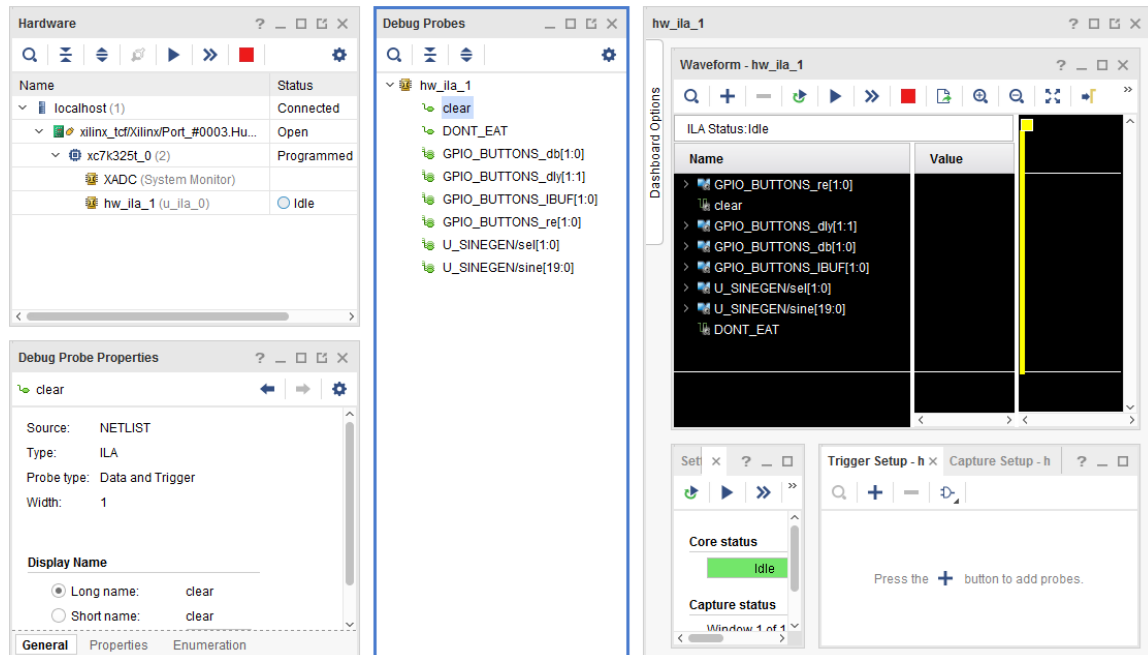

15. Run the Trigger on the ILA. Ensure the probes that were replaced in step 8 and 9 above are reflected in the Waveform window as well.

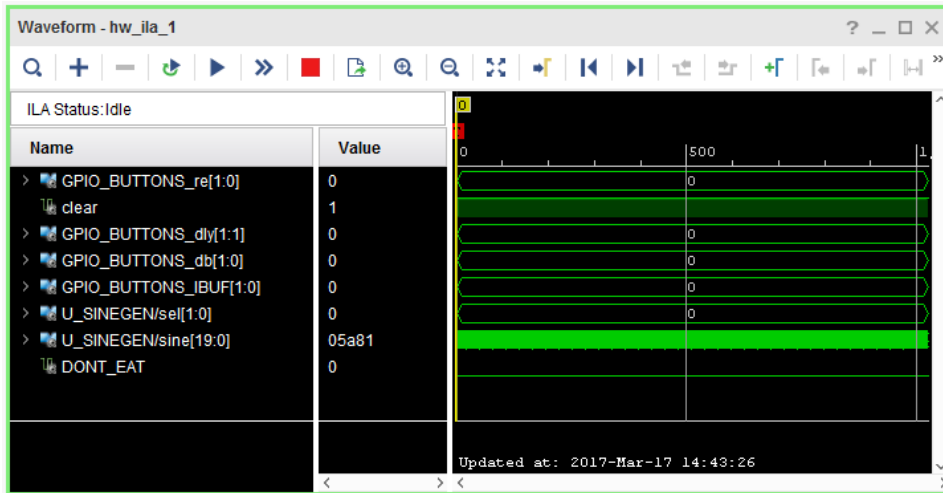

# Debugging Designs Using the Incremental Compile Flow

This lab introduces the Vivado® Incremental Compile Flow to add/edit/delete debug cores to an earlier implementation of the design.

---

## Procedure

This lab consists of five generalized steps followed by general instructions and supplementary detailed steps that allow you to make choices based on your skill level as you progress through the lab.

If you need help completing a general instruction, go to the detailed steps below it, or if you are ready, simply skip the step-by-step directions and move on to the next general instruction.

The lab has five primary steps as follows:

1. [Step 1: Opening the Example Design and Adding a Debug Core](#)
2. [Step 2: Compiling the Reference Design](#)
3. [Step 3: Create New Runs](#)
4. [Step 4: Making Incremental Debug Changes](#)
5. [Step 5: Running Incremental Compile](#)

---

## Step 1: Opening the Example Design and Adding a Debug Core

1. Start the Vivado IDE.

Load the Vivado IDE by doing one of the following:

- Double-click the Vivado IDE icon on the Windows desktop.
- Type `vivado` in a command terminal.



From the Getting Started page, click **Open Example Project**.

2. In the Open Example Project dialog box, click **Next**.
3. Select the CPU (Synthesized) design template, and click **Next**.
4. In the Project Name dialog box, specify the following:
  - Project name: `project_cpu_incremental`
  - Project location: `<Project_Dir>`

Click **Next**.

5. In the Default Part screen, select **xc7k70tfg676-2** and click **Next**.
6. The New Project Summary screen appears, displaying project details. Reviewed these and click **Finish**.
7. When the Vivado IDE opens with the default view, open the Synthesized design.
8. In the Netlist window, select the set of signals specified below in the `cpuEngine` hierarchy and apply the `MARK_DEBUG` property by right-clicking and selecting **Mark Debug** from the dialog.

```
cpuEngine/dcqmem_dat_qmem[*],
cpuEngine/dcpu_dat_qmem[*],
cpuEngine/dcqmem_adr_qmem[*],
cpuEngine/du_dsr[*],
cpuEngine/dvr0_0[*],
cpuEngine/du_dsr[*],
cpuEngine/dcqmem_sel_qmem[*]
```

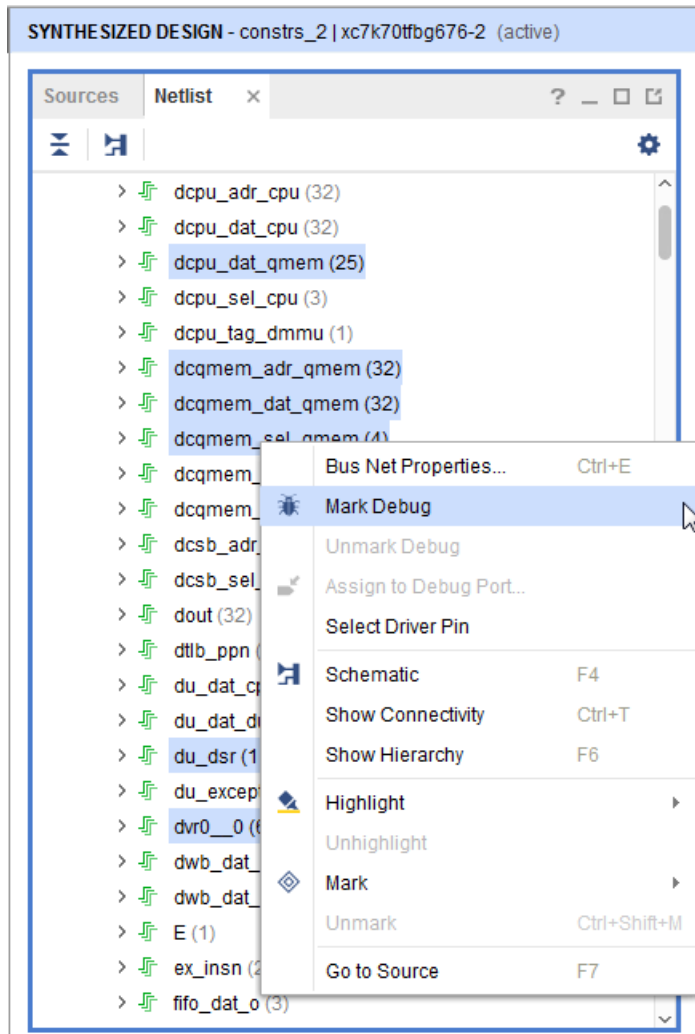

Alternatively, you can use the following Tcl command to set the MARK\_DEBUG property on the signals specified.

```
set_property mark_debug true [get_nets [list {cpuEngine/
dcqmem_dat_qmem[*]}
{cpuEngine/dcpu_dat_qmem[*]} {cpuEngine/dcqmem_adr_qmem[*]}
{cpuEngine/du_dsr[*]} {cpuEngine/dvr0__0[*]} {cpuEngine/du_dsr[*]}
{cpuEngine/dcqmem_sel_qmem[*]}]]
```

9. In the Flow Navigator, click **Set Up Debug** to invoke the Set Up Debug wizard.

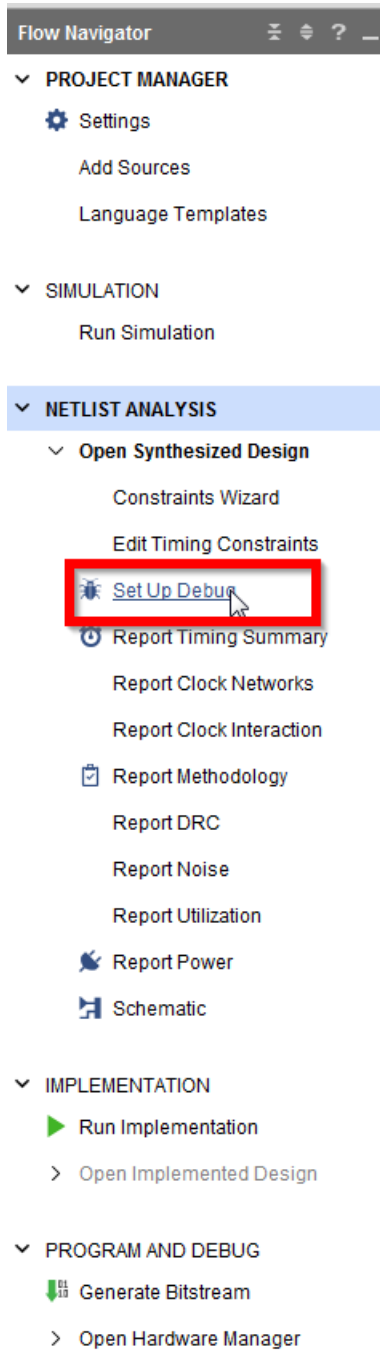

10. When the Set Up Debug Wizard appears, click **Next**.

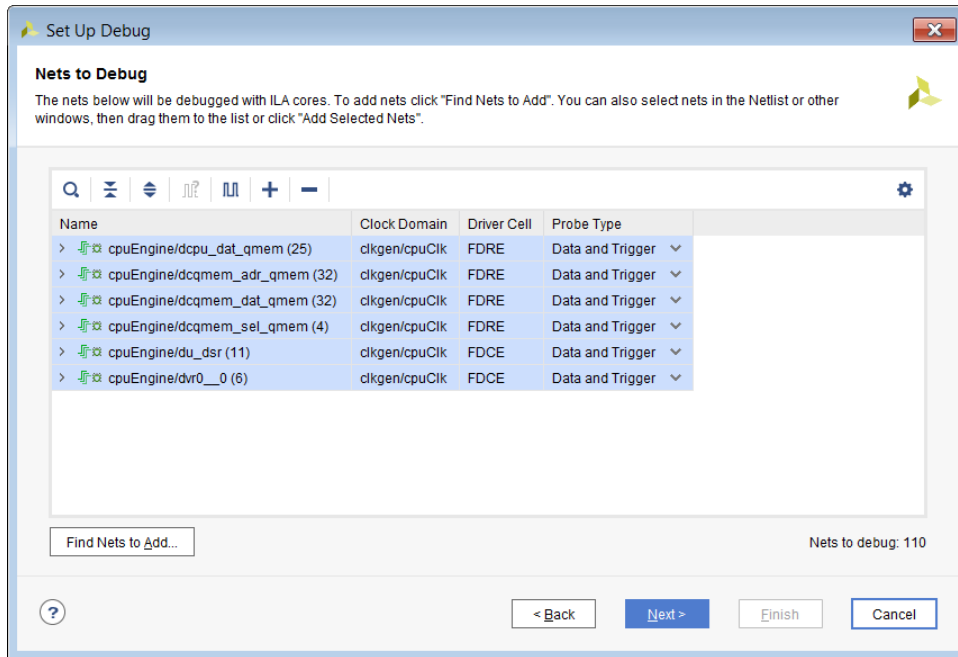

- When the ILA Core Options screen appears, click **Next** again.
- When the Set Up Debug Summary screen appears, ensure that one debug core is created and click **Finish**.
- Check the Debug widow to ensure that the u\_ila\_0 core has been inserted into the design.

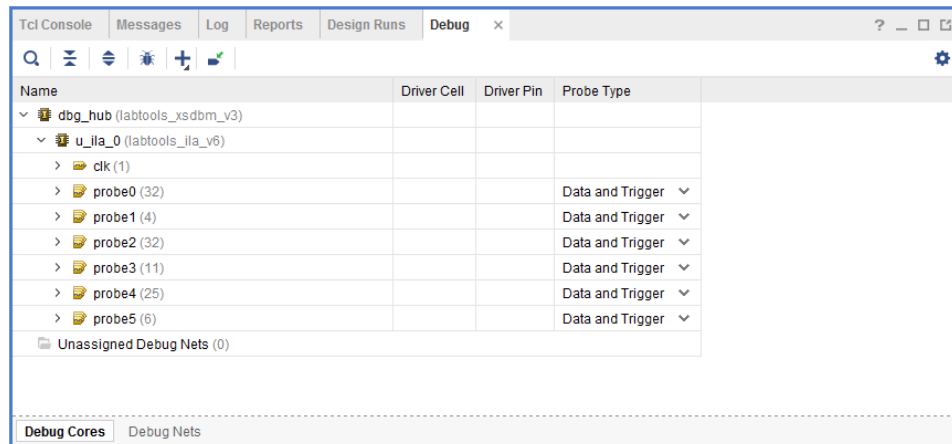

- Save the new debug XDC commands by selecting **File** → **Constraints** → **Save** or clicking the **Save Constraints** button.

## Step 2: Compiling the Reference Design

The following are the steps to run implementation on the reference design.

1. From the Flow Navigator, select **Run Implementation**.
2. After implementation finishes, the Implementation Complete dialog box opens. Click **Cancel**.
3. In a project-based design, the Vivado Design Suite saves intermediate implementation results as design checkpoints in the implementation runs directory. You will use one of the saved design checkpoints from the implementation in the incremental compile flow.



**TIP:** When you re-run implementation, the previous results will be deleted. Save the intermediate implementation results to a new directory or create a new implementation run for your incremental compile to preserve the reference implementation run directory.

4. In the Design Runs window, right-click **impl\_1** and select **Open Run Directory** from the popup menu. This opens the run directory in a file browser as seen in the following figure. The run directory contains the routed checkpoint (`top_routed.dcp`) to be used later for the incremental compile flow. The location of the implementation run directory is a property of the run.
5. Get the location of the current run directory in the Tcl Console by typing:

```
get_property DIRECTORY [current_run]
```

This returns the path to the current run directory that contains the design checkpoint. You can use this Tcl command, and the DIRECTORY property, to locate the DCP files needed for the incremental compile flow.

## Step 3: Create New Runs

In this step, you define new synthesis and implementation runs to preserve the results of the current runs. Then you make debug related changes to the design and rerun synthesis and implementation. If you do not create new runs, Vivado overwrites the current results.

1. From the Vivado tool bar, select **Flow → Create Runs** to invoke the Create New Runs wizard.
2. In the Create New Runs screen, click **Next**.
3. The Configure Implementation Runs screen opens, as shown in the figure below. Select the Make Active check box, and click **Next**.

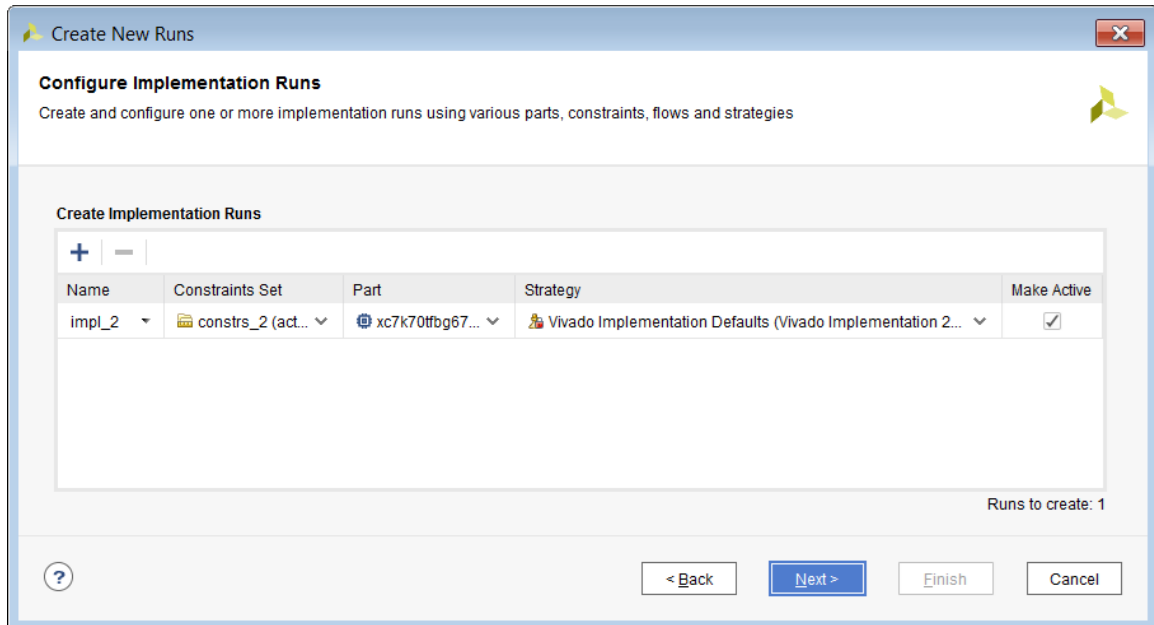

- From the Launch Options window, select Do not launch now and click **Next**.

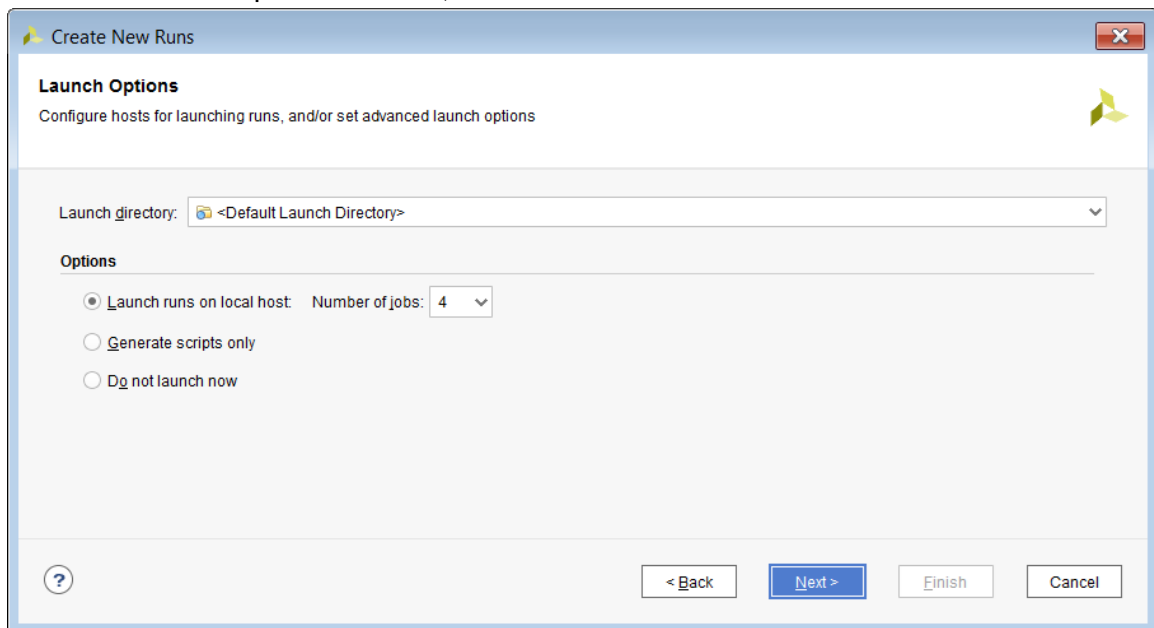

- In the Create New Runs Summary screen, click **Finish** to create the new runs.  
The Design Runs window displays the new active runs in bold.

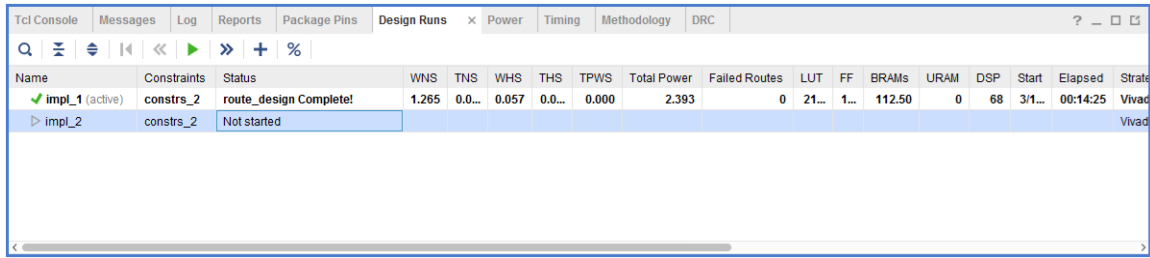

## Step 4: Making Incremental Debug Changes

In this step, to add/delete/edit debug cores, you need to reopen the synthesized netlist. Make debug related changes to the design using the Set Up Debug wizard.

1. If you have closed the synthesized netlist, go back to the synthesized design using the Flow Navigator.
2. For this tutorial, assume that you now need to debug some other nets in addition to the ones already being debugged. However, you want to reuse the previous place and route results. Now, you will debug the nets `fftEngine/fifo_out[*]`.
3. Apply the `MARK_DEBUG` property to this bus in the netlist window.

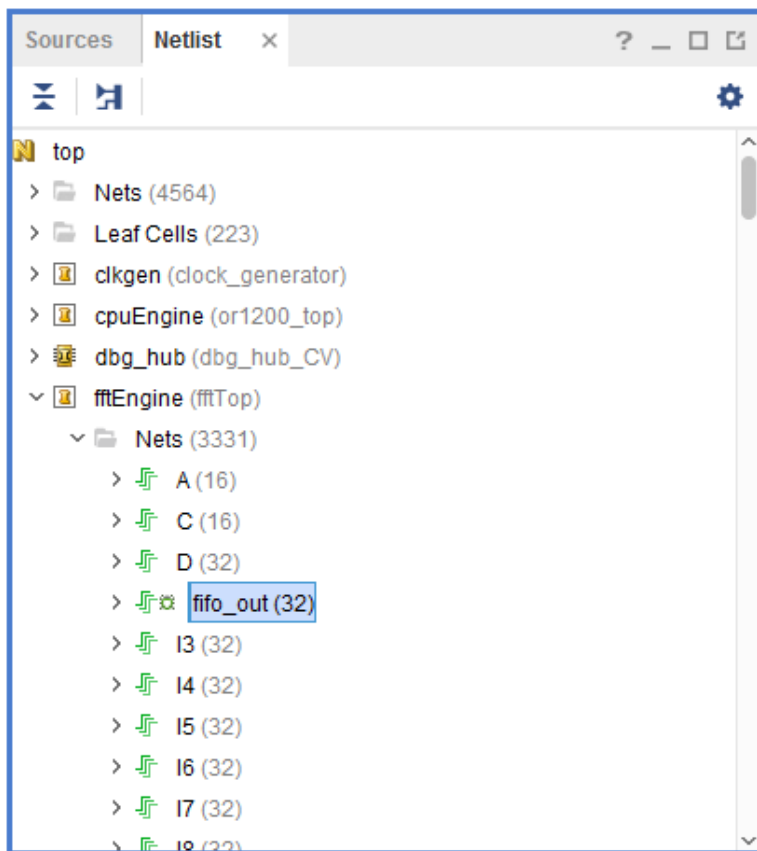

- Click **Set Up** Debug to invoke the Set Up Debug wizard in the Flow Navigator.
- In the Existing Debug Nets tab, select **Continue debugging 110 nets connected to existing debug core**.

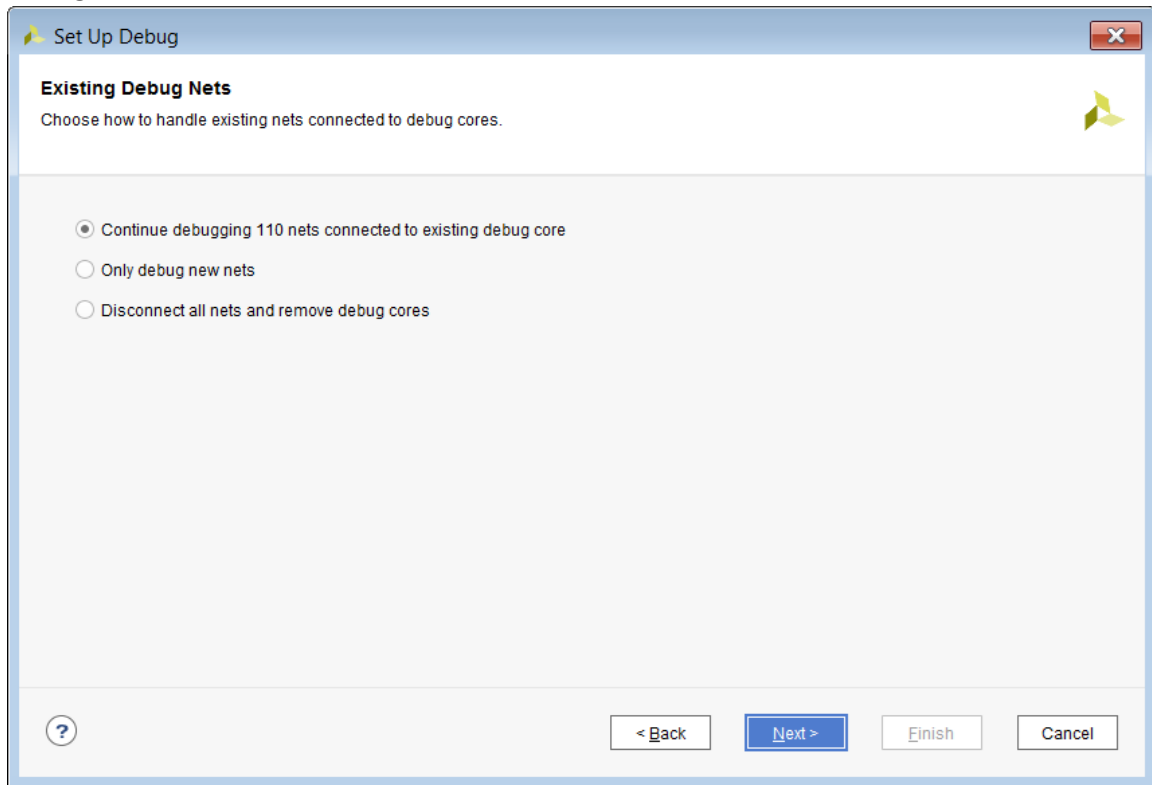

- Click **Next** to debug the new unassigned debug nets.



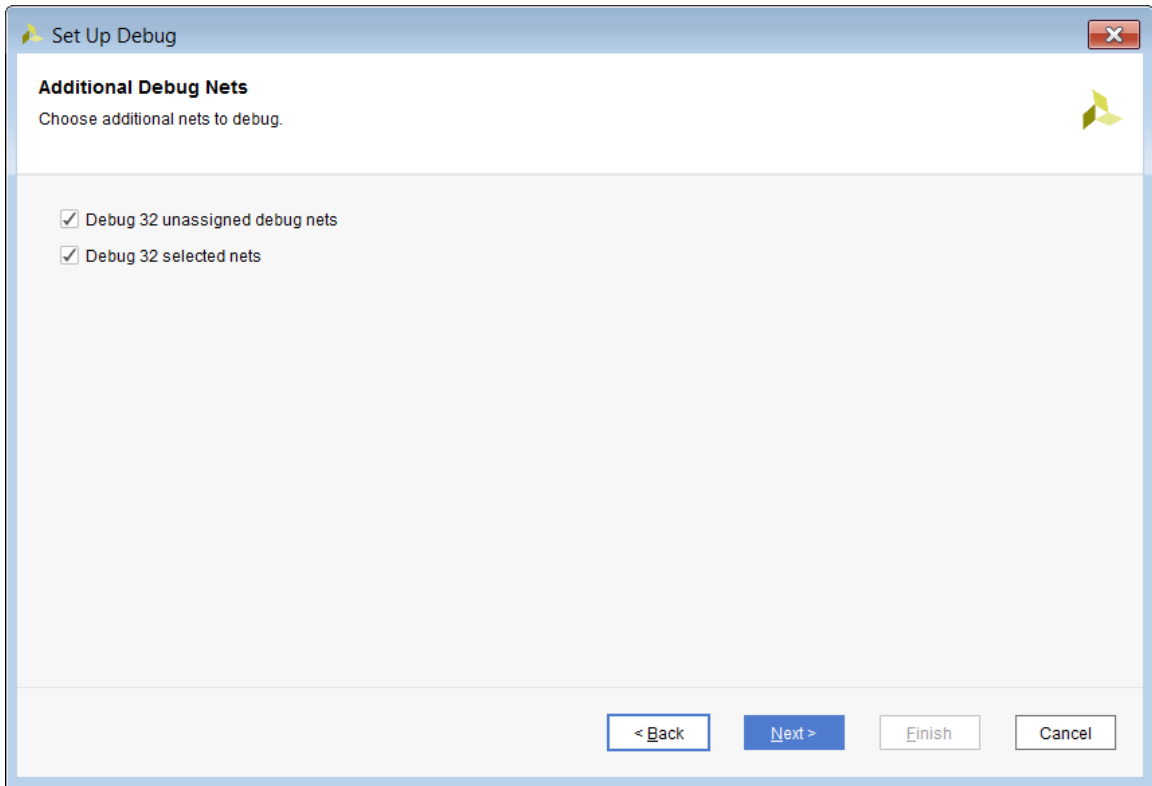

7. Click **Next** and ensure the new nets are in the list of Nets to Debug.

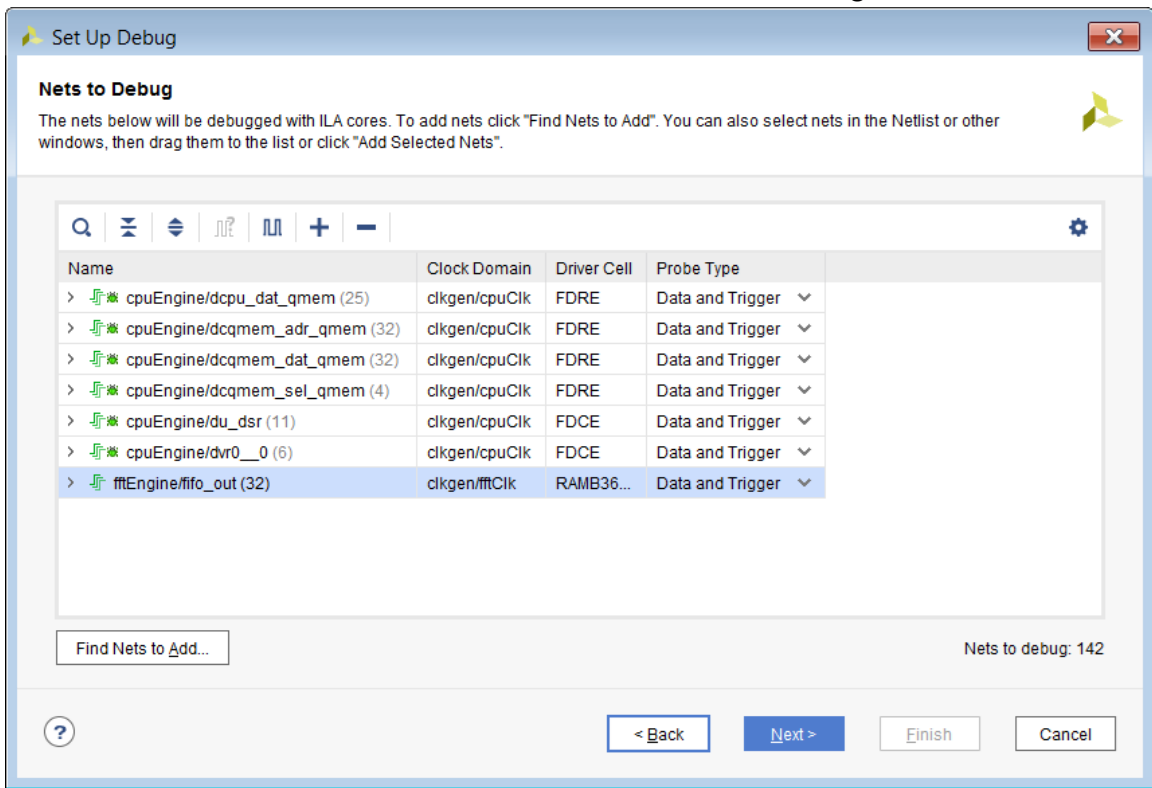

8. Click **Next** and ensure that two debug cores are created and click **Finish**.

9. Save the new debug XDC commands by clicking the **Save Constraints** button or selecting **File** → **Constraints** → **Save** from the main Vivado toolbar.

---

## Step 5: Running Incremental Compile

In the previous steps, you have updated the design with debug changes. You could run implementation on the new netlist, to place and route the design and work to meet the timing requirements. However, with only minor changes between this iteration and the last, the incremental compile flow lets you reuse the bulk of your prior debug, placement and routing efforts. This can greatly reduce the time it takes to meet timing on design iterations. For more information, refer to *Vivado Design Suite User Guide: Implementation* (UG904).

1. Start by defining the design checkpoint (DCP) file to use as the reference design for the incremental compile flow. This is the design from which the Vivado Design Suite draws placement and routing data.
2. In the Design Runs window, right-click the **impl\_2 run** and select **Set Incremental Implementation** from the popup menu. The **Set Incremental Implementation** dialog box opens.
3. Select **Automatically use the checkpoint from the previous run**.
4. Click **OK**. This information is stored in the `INCREMENTAL_CHECKPOINT` property of the selected run. Setting this property tells the Vivado Design Suite to run the incremental compile flow during implementation.
5. You can check this property on the current run using the following Tcl command:

```
get_property INCREMENTAL_CHECKPOINT [current_run]
```

This returns the full path to the `top_routed.dcp` checkpoint.



**TIP:** To disable Incremental Compile for the current run, clear the `INCREMENTAL_CHECKPOINT` property. This can be done using the **Set Incremental Compile** dialog box, or by editing the property directly through the **Properties** window of the design run, or through the `reset_property` command.

6. From the Flow Navigator, select **Run Implementation**.  
This runs implementation on the current run, using the `top_routed.dcp` file as the reference design for the incremental compile flow. When the run is finished, the **Implementation Completed** dialog box opens.
7. Select **Open Implemented Design** and click **OK**. As shown in the following figure, the Design Runs window shows the elapsed time for implementation run `impl_2` versus `impl_1`.

Name	Constraints	Status	WNS	TNS	WHS	THS	TPWS	Total Power	Failed Routes	LUT	FF	BRAMs	URAM	DSP	Start	Elapsed	Run Strategy
impl_1	constrs_2	Implementation Out-of-date	0.530	0.000	0.041	0.000	0.000	2.395	0	21386	18106	112.50	0	68	4/18/18 5:11 PM	00:10:36	Vivado Imple
impl_2 (active)	constrs_2	route_design Complete!	0.530	0.000	0.055	0.000	0.000	2.408	0	22029	19264	113.50	0	68	4/18/18 5:26 PM	00:10:05	Vivado Imple

**Note:** This is an extremely small design. The advantages of the incremental compile flow are greater and significant with larger, more complex designs.

8. Select the Reports tab in the Results window area and under Place Design, double-click **Incremental Reuse Report** as shown in the following figure.

Report	Report Type	Options
impl_2		
Design Initialization (init_design)		
Opt Design (opt_design)		
Power Opt Design (power_opt_design)		
Place Design (place_design)		
impl_2_place_report_io_0	Report information about all the IO sites on the device (report_io)	
impl_2_place_report_utilization_0	Report on utilization of resources on the targeted device (report_utilization)	slr = false; packthru = false; hierarchical = false
impl_2_place_report_control_sets_0	Report the unique control sets in design (report_control_sets)	verbose = true;
impl_2_place_report_incremental_reuse_0	Report on achievable incremental reuse for the given design-checkpoint (report_incremental_reuse)	hierarchical = false;
impl_2_place_report_incremental_reuse_1	Report on achievable incremental reuse for the given design-checkpoint (report_incremental_reuse)	hierarchical = false;
impl_2_place_report_timing_summary_0	Report timing summary (report_timing_summary)	check_timing_verbose = false; setup = false;
Post-Place Power Opt Design (post_place_power_opt_design)		
Post-Place Phys Opt Design (phys_opt_design)		
Route Design (route_design)		
Post-Route Phys Opt Design (post_route_phys_opt_design)		
Write Bitstream (write_bitstream)		

The Incremental Reuse Report opens in the Vivado IDE text editor. This report shows the percentage of reused Cells, Ports, and Nets. A higher percentage indicates more effective reuse of placement and routing from the incremental checkpoint.

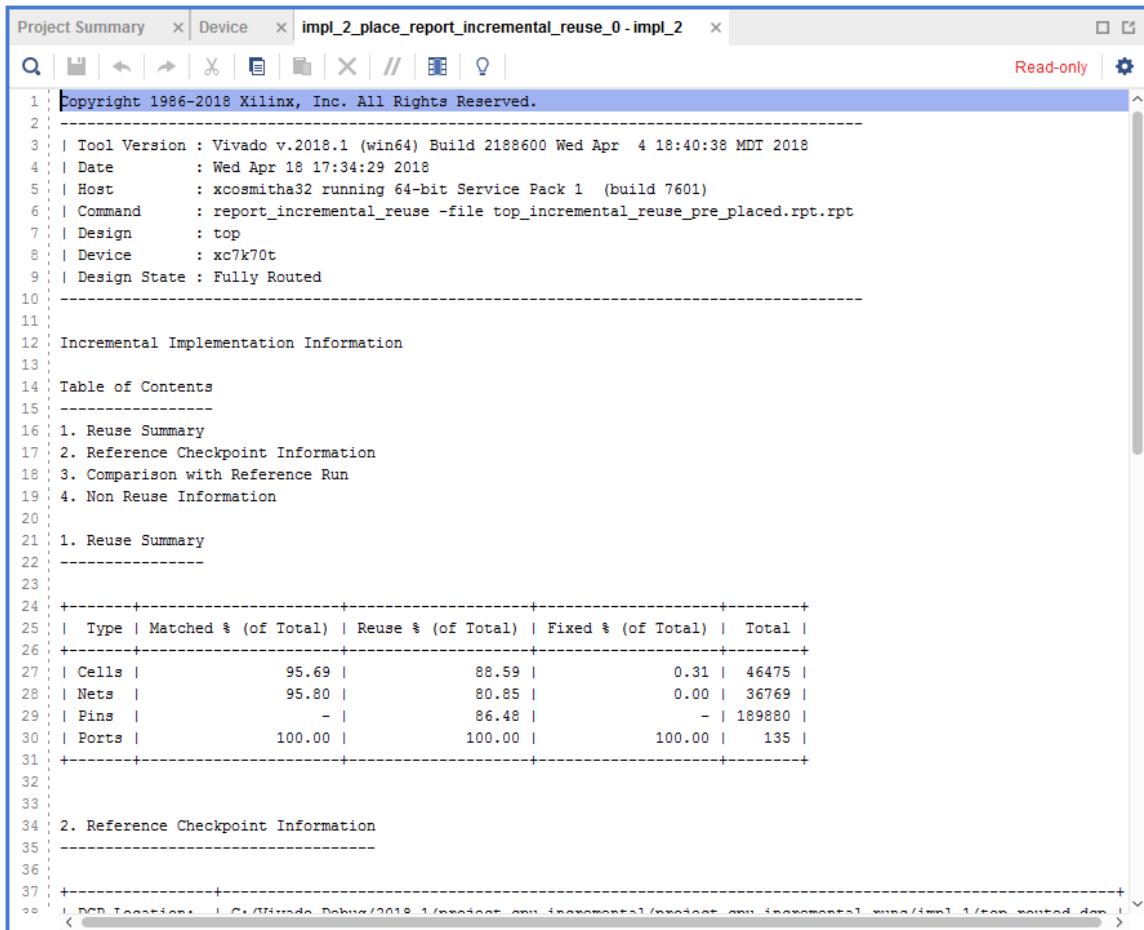

```

1 | Copyright 1986-2018 Xilinx, Inc. All Rights Reserved.
2 |
3 | -----
4 | Tool Version : Vivado v.2018.1 (win64) Build 2188600 Wed Apr  4 18:40:38 MDT 2018
5 | Date       : Wed Apr 18 17:34:29 2018
6 | Host      : xcsmitha32 running 64-bit Service Pack 1 (build 7601)
7 | Command   : report_incremental_reuse -file top_incremental_reuse_pre_placed.rpt.rpt
8 | Design    : top
9 | Device    : xc7k70t
10 | Design State : Fully Routed
11 | -----
12 | Incremental Implementation Information
13 |
14 | Table of Contents
15 | -----
16 | 1. Reuse Summary
17 | 2. Reference Checkpoint Information
18 | 3. Comparison with Reference Run
19 | 4. Non Reuse Information
20 |
21 | 1. Reuse Summary
22 | -----
23 |
24 | +-----+-----+-----+-----+-----+
25 | | Type | Matched % (of Total) | Reuse % (of Total) | Fixed % (of Total) | Total |
26 | +-----+-----+-----+-----+-----+
27 | | Cells | 95.69 | 88.59 | 0.31 | 46475 |
28 | | Nets | 95.80 | 80.85 | 0.00 | 36769 |
29 | | Pins | - | 86.48 | - | 189880 |
30 | | Ports | 100.00 | 100.00 | 100.00 | 135 |
31 | +-----+-----+-----+-----+-----+
32 |
33 |
34 | 2. Reference Checkpoint Information
35 | -----
36 |
37 | +-----+-----+-----+-----+-----+
38 | | PCB Location: | C:\Xilinx\Debug\2018.1\project_001_incremental\project_001_incremental_run\impl_1\top_routed.dcp |
39 | +-----+-----+-----+-----+-----+
    
```

In the report, fully reused nets indicate that the entire routing of the nets is reused from the reference design. Partially reused nets indicate that some of the routing of the nets reuses routing from the reference design. Some segments re-route due to changed cells, changed cell placements, or both. Non-reused nets indicate that the net in the current design was not matched in the reference design.

## Conclusion

This concludes the lab. You can close the current project and exit the Vivado IDE.

In this lab, you learned how to run the Incremental Compile Debug flow, using a checkpoint from a previously implemented design. You inserted a new debug core using the Set Up Debug wizard on the synthesized netlist. You examined the similarity between a reference design checkpoint and the current design by examining the Incremental Reuse Report.

# Using the Vivado Serial Analyzer to Debug Serial Links

The Serial I/O analyzer is used to interact with IBERT debug IP cores contained in a design. It is used to debug and verify issues in high speed serial I/O links.

The Serial I/O Analyzer has several benefits:

- Tight integration with Vivado® IDE.
- Ability to script during netlist customization/generation and serial hardware debug.
- Common interface with the Vivado Integrated Logic Analyzer (ILA).

The customizable LogiCORE™ IP Integrated Bit Error Ratio Tester (IBERT) core for 7 series FPGA GTX transceivers is designed for evaluating and monitoring the GTX transceivers. This core includes pattern generators and checkers that are implemented in FPGA logic, and provides access to ports and the dynamic reconfiguration port attributes of the GTX transceivers. Communication logic is also included to allow the design to be run time accessible through JTAG.

In the course of this tutorial, you:

- Create, customize, and generate an Integrated Bit Error Ratio Tester (IBERT) core design using the Vivado tool.
- Interact with the design using Serial I/O Analyzer. This includes connecting to the target KC705 board, configuring the device, and interacting with the IBERT/Transceiver IP cores.
- Perform a sweep test to optimize your transceiver channel and to plot data using the IBERT sweep plot GUI feature.

---

## Design Description

You can customize the IBERT core and use it to evaluate and monitor the functionality of transceivers for a variety of Xilinx® devices. The focus for this tutorial is on Kintex®-7 GTX transceivers. Accordingly, the KC705 target board is used for this tutorial.

The following figure shows a block diagram of the interface between the IBERT Kintex-7 GTX core interfaces with Kintex-7 transceivers.

- DRP Interface and GTX Port Registers:** IBERT provides you with the flexibility to change GTX transceiver ports and attributes. Dynamic reconfiguration port (DRP) logic is included, which allows the runtime software to monitor and change any attribute in any of the GTX transceivers included in the IBERT core. When applicable, readable and writable registers are also included. These are connected to the ports of the GTX transceiver. All are accessible at run time using the Vivado® logic analyzer.
- Pattern Generator:** Each GTX transceiver enabled in the IBERT design has both a pattern generator and a pattern checker. The pattern generator sends data out through the transmitter.
- Error Detector:** Each GTX transceiver enabled in the IBERT design has both a pattern generator and a pattern checker. The pattern checker takes the data coming in through the receiver and checks it against an internally generated pattern.

Figure 4: IBERT Design Flow

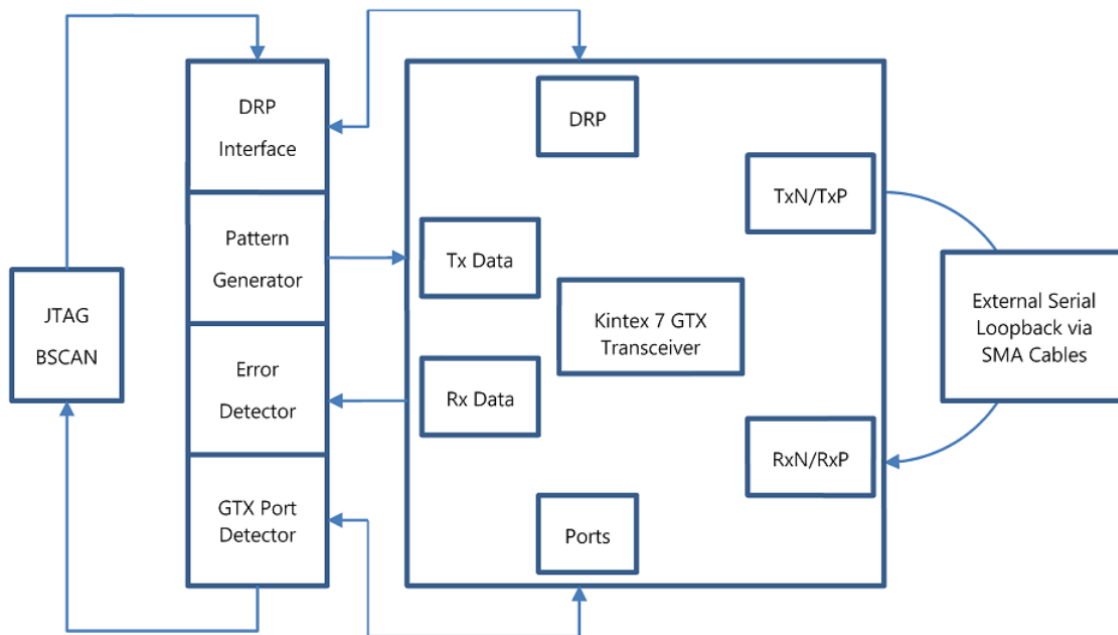

## Step 1: Creating, Customizing, and Generating an IBERT Design

To create a project, use the New Project wizard to name the project, to add RTL source files and constraints, and to specify the target device.

1. Invoke the Vivado IDE.

2. In the Quick Start screen, click **Create Project** to start the New Project wizard, and click **Next**.
3. In the Project Name page, name the new project `ibert_tutorial` and provide the project location (`C:/ibert_tutorial`). Ensure that **Create Project Subdirectory** is selected. Click **Next**.
4. In the Project Type page, specify the Type of Project to create as RTL Project. Click **Next**.
5. In the Add Sources page, click **Next**.
6. In the Add Existing IP page, click **Next**.
7. In the Add Constraints page, click **Next**.
8. In the Default Part page, select Boards and then select Kintex-7 KC705 Evaluation Platform. Click **Next**.
9. Review the New Project Summary page. Verify that the data appears as expected, per the steps above. Click **Finish**.

**Note:** It might take a moment for the project to initialize.

---

## Step 2: Adding an IBERT Core to the Vivado Project

1. In the Flow Navigator click **IP Catalog**.

The IP Catalog opens.

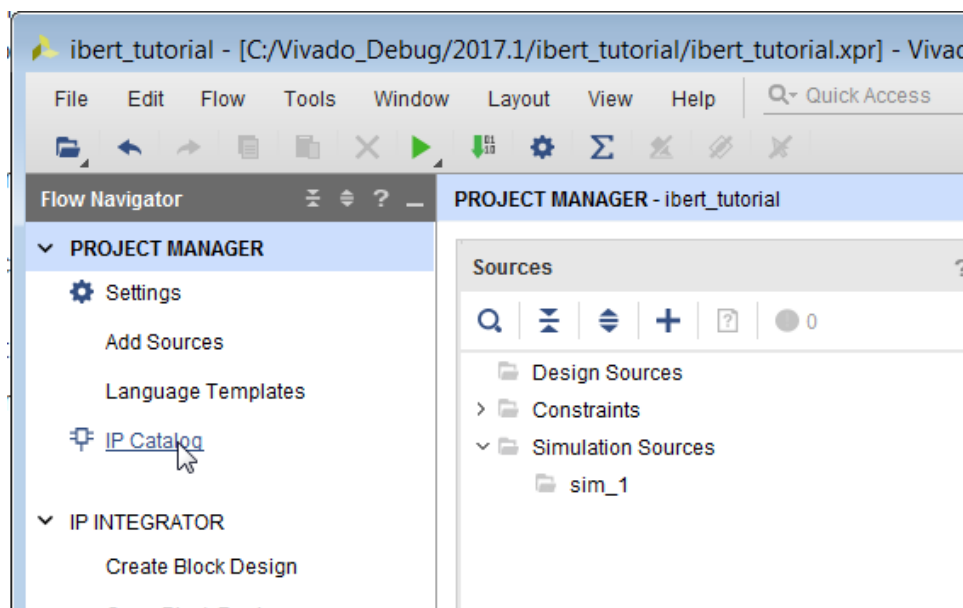

2. In the search field of the IP Catalog type `IBERT`, to display the IBERT 7 series GTX IP.

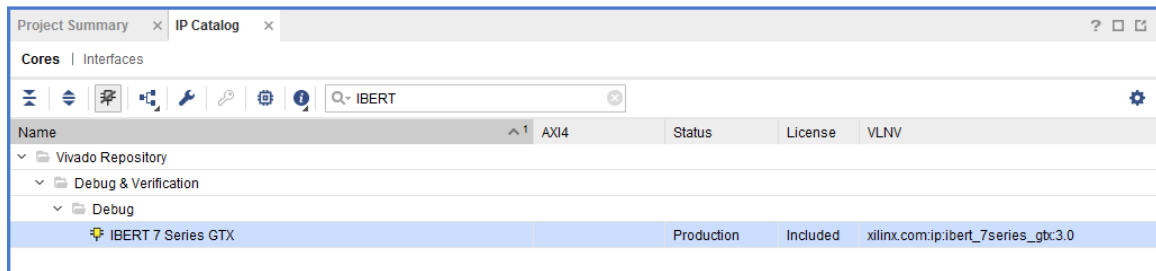

3. Double-click **IBERT 7 series GTX IP**. This brings up the customization GUI for the IBERT.
4. In the Customize IP dialog box, choose the following options in the Protocol Definition tab:
  - a. Type the name of the component in the Component Name field. In this case, leave the name as the default name, `ibert_7series_gtx_0`.
  - b. Ensure that the Silicon Version is selected as General ES/Production.
  - c. Ensure that the Number of Protocols option is set to 1.
  - d. Change the LineRate (Gb/s) to 8.
  - e. Change DataWidth to 40.
  - f. Change Refclk (MHz) to 125.
  - g. Ensure that the Quad Count is set to 2.
  - h. Ensure Quad PLL box is selected.

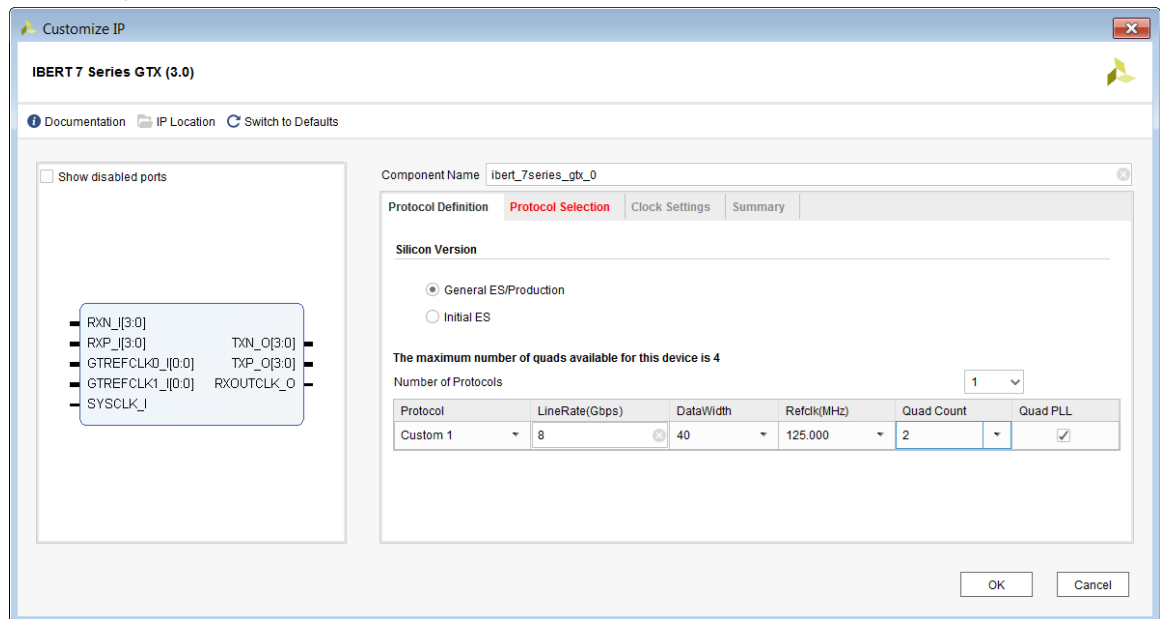

5. Under the Protocol Selection tab, update the following selections:
  - a. For GTX Location QUAD\_117, in the Protocol Selected column, click the pull-down menu and select **Custom 1 / 8 Gbps**. This should automatically populate Refclk Selection to MGTREFCLK0 117 and TXUSRCLK Source to Channel 0.



- b. For GTX Location QUAD\_118, do the following:
  - i. In the Protocol Selected column, click the pull-down menu and select **Custom 1 / 8 Gbps**.
  - ii. In the Refclk Selection column, change the value to MGTREFCLK0 117.
  - iii. In the TXUSRCLK Source column, change the value to Channel 0.

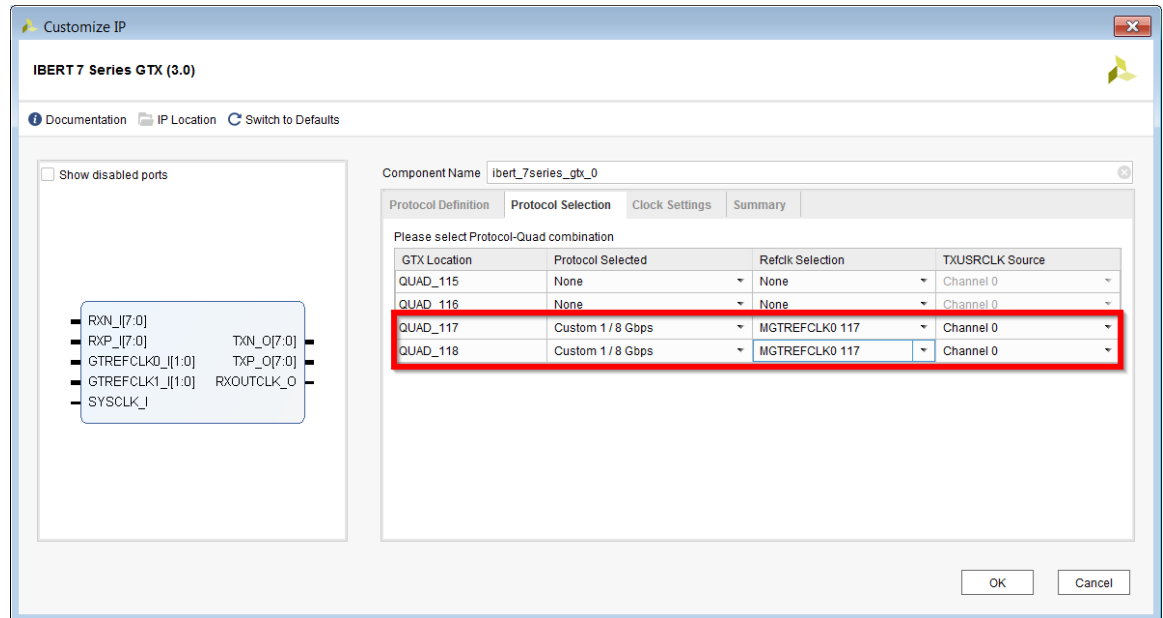

- 6. Click the **Clock Settings** tab and make the following changes for both QUAD\_117 and QUAD\_118:
  - a. Leave the Source column at its default value of External.
  - b. Change the I/O Standard column to DIFF SSTL15.
  - c. Change the P Package Pin to AD12.
  - d. Change the N Package Pin to AD11.
  - e. Leave the Frequency (MHz) at its default value of 200.00.

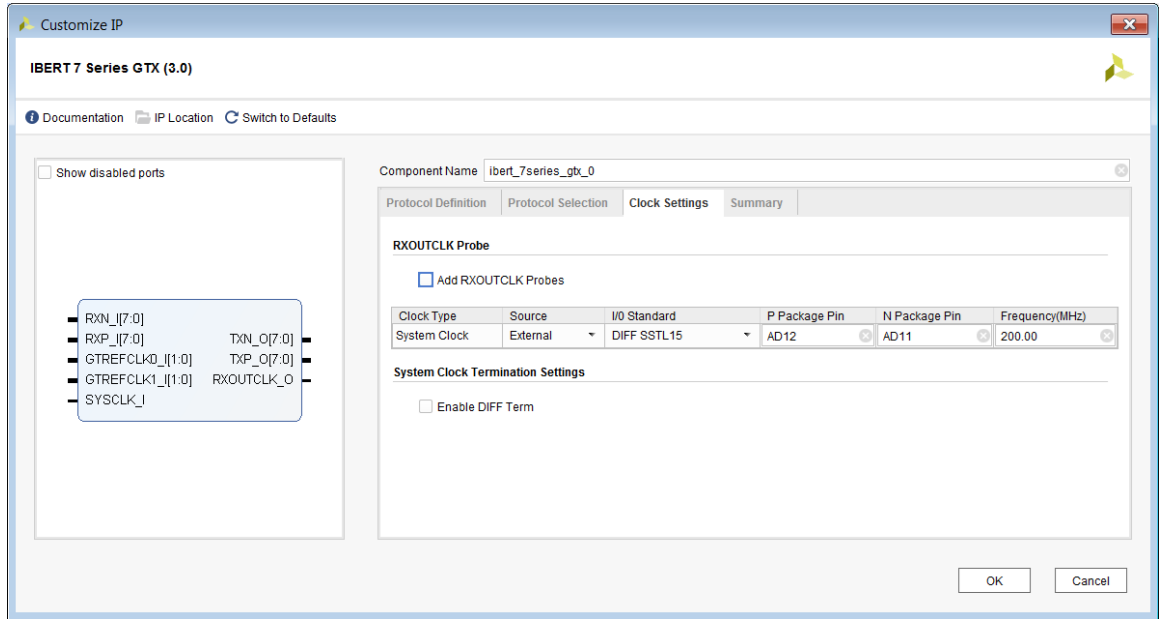

- Click the Summary tab and ensure that the content matches the following figure, then click **OK**.

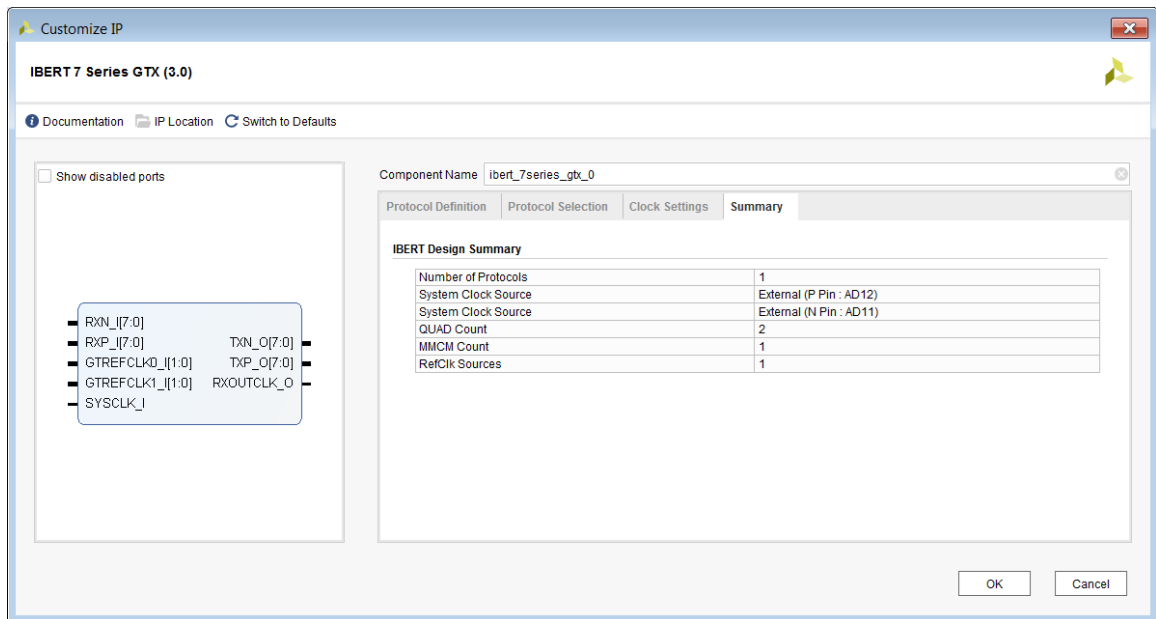

- When the Generate Output Products dialog box opens, click **Generate**.

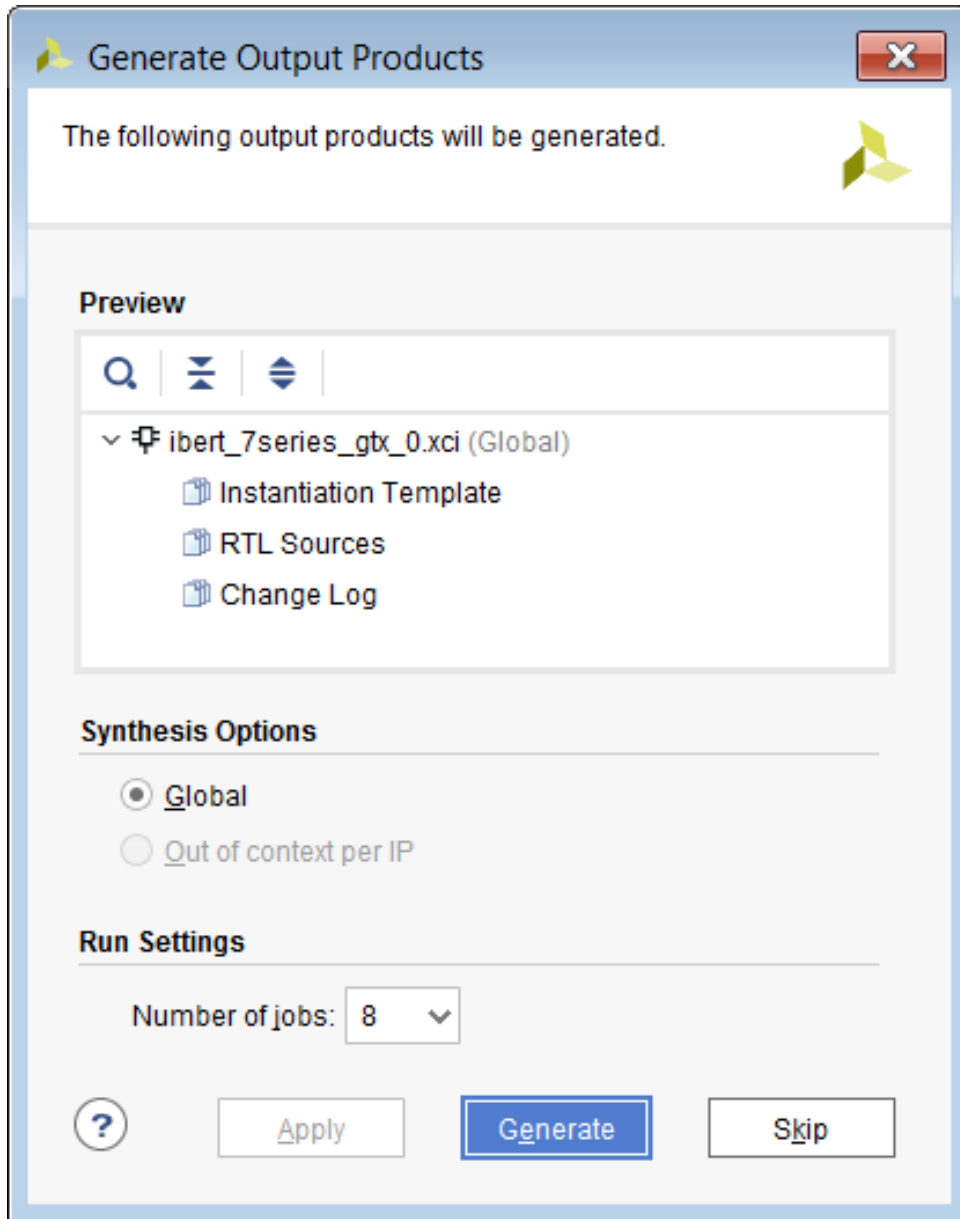

- In the Sources window, right-click the IP, and select **Open IP Example Design**.

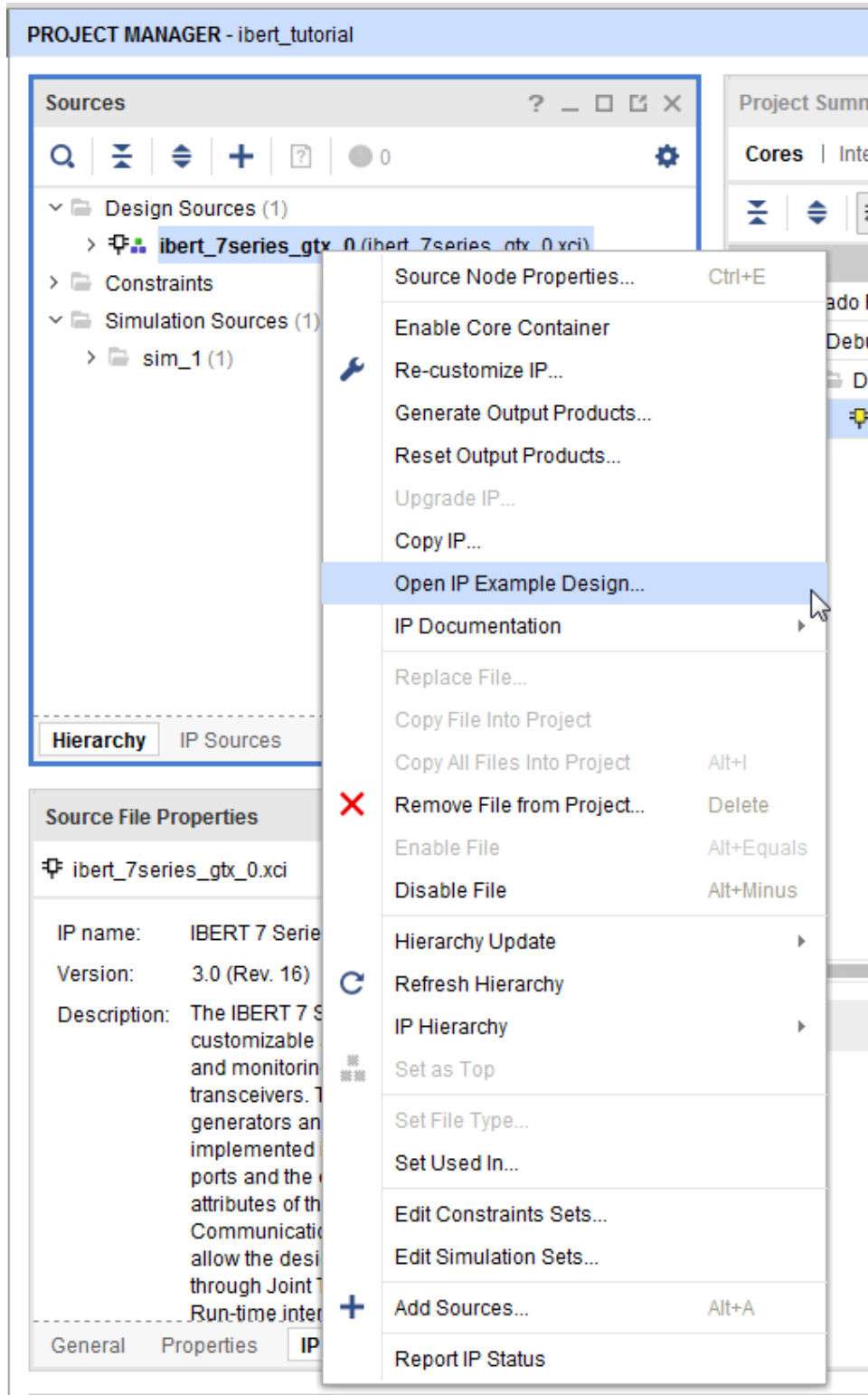

10. In the Open IP Example Design dialog box, and specify the location of your project directory. Ensure that the Overwrite existing example project is selected and click **OK**.

**Note:** This opens a new instance of Vivado® IDE with the new example design opened.

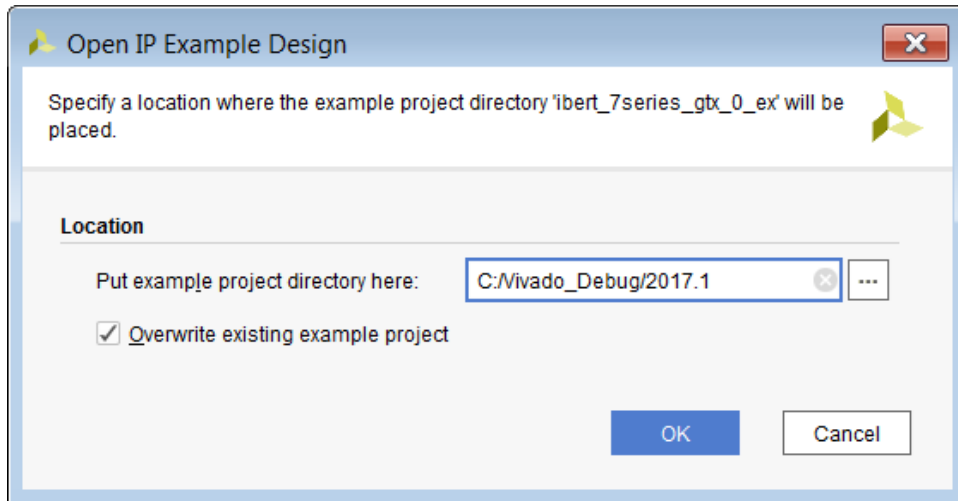

## Step 3: Synthesize, Implement and Generate Bitstream for the IBERT Design

1. In the newly opened instance of Vivado IDE, click **Generate Bitstream** in the Flow Navigator. When the No Implementation Results Available dialog box appears. Click **Yes**.

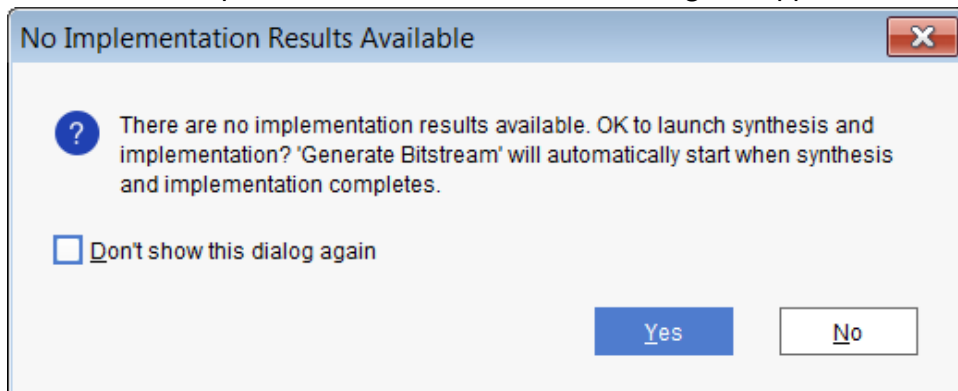

When the bitstream generation is complete, the Bitstream Generation Completed dialog box opens.

2. Select **Open Hardware Manager**, and click **OK**.

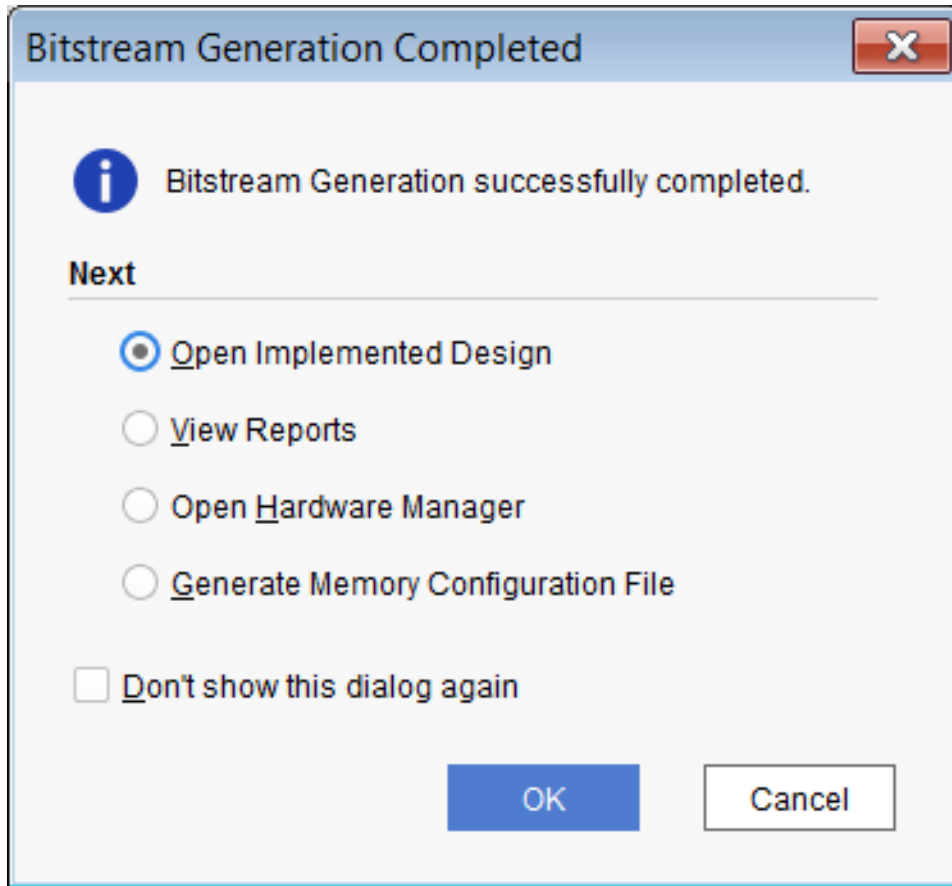

3. The Hardware Manager window appears as shown in the following figure.

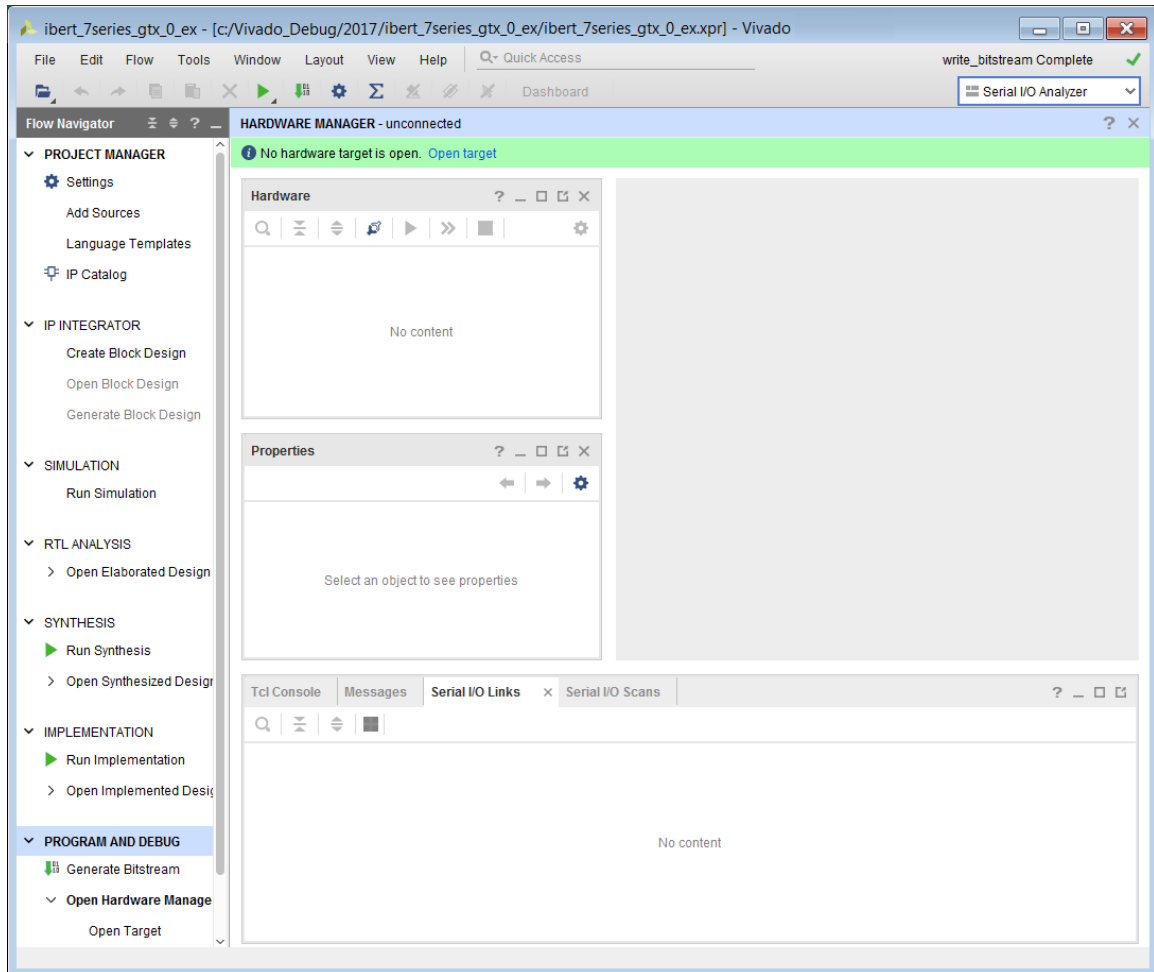

## Step 4: Interact with the IBERT Core Using Serial I/O Analyzer

In this tutorial step, you connect to the KC705 target board, program the bitstream created in the previous step, and then use the Serial I/O Analyzer to interact with the IBERT design that you created in Step 1. You perform some analysis using various input patterns and loopback modes, while observing the bit error count.

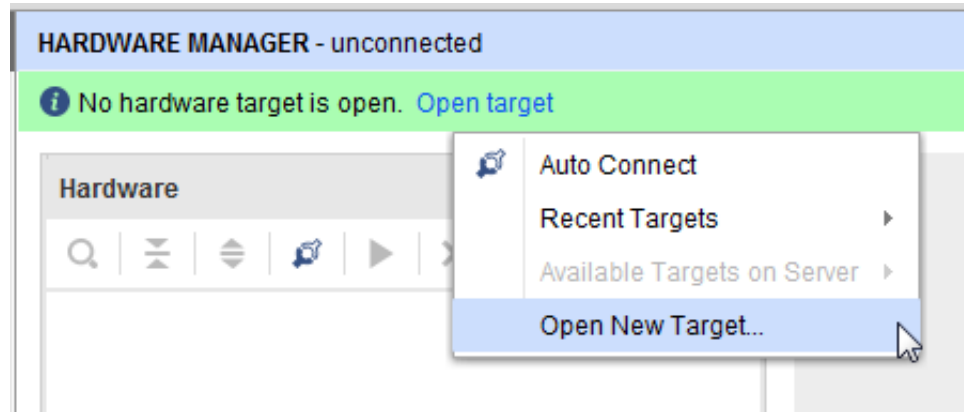

1. Click **Open New Target**. When the Open Hardware Target wizard opens, click **Next**.

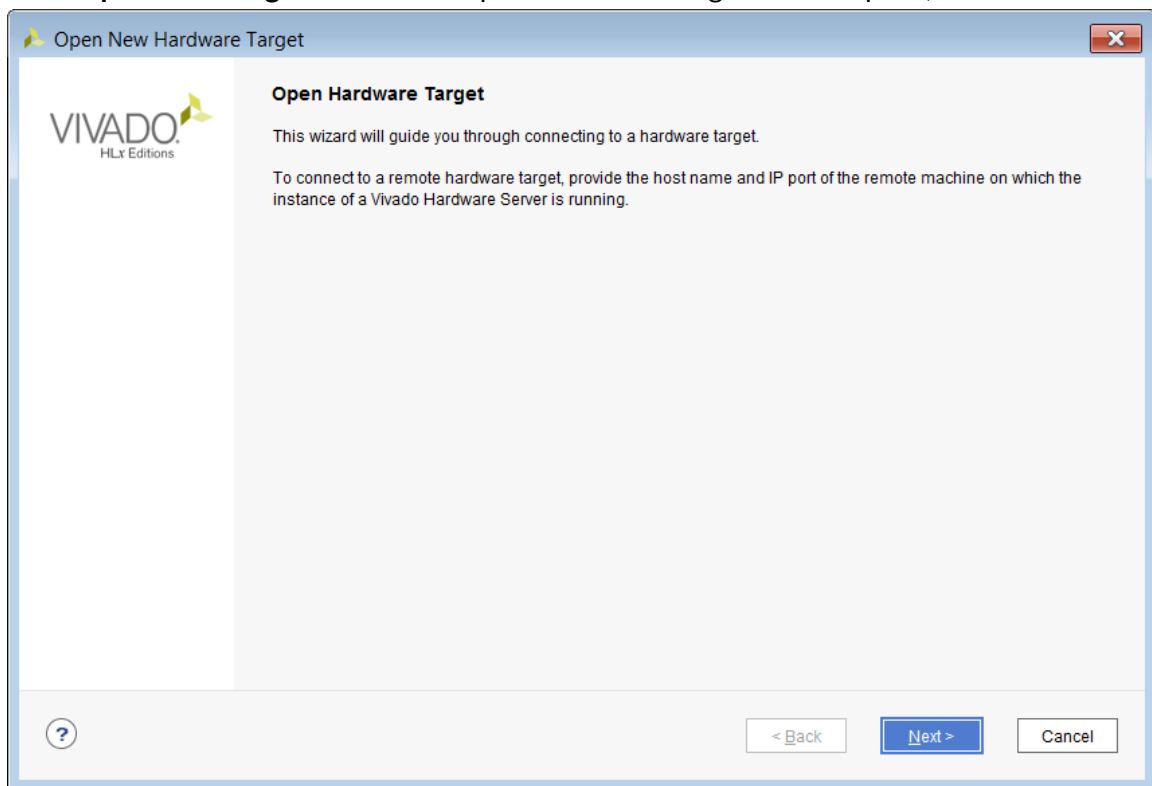

2. In the Connect to field, choose Local server. Click **Next**.



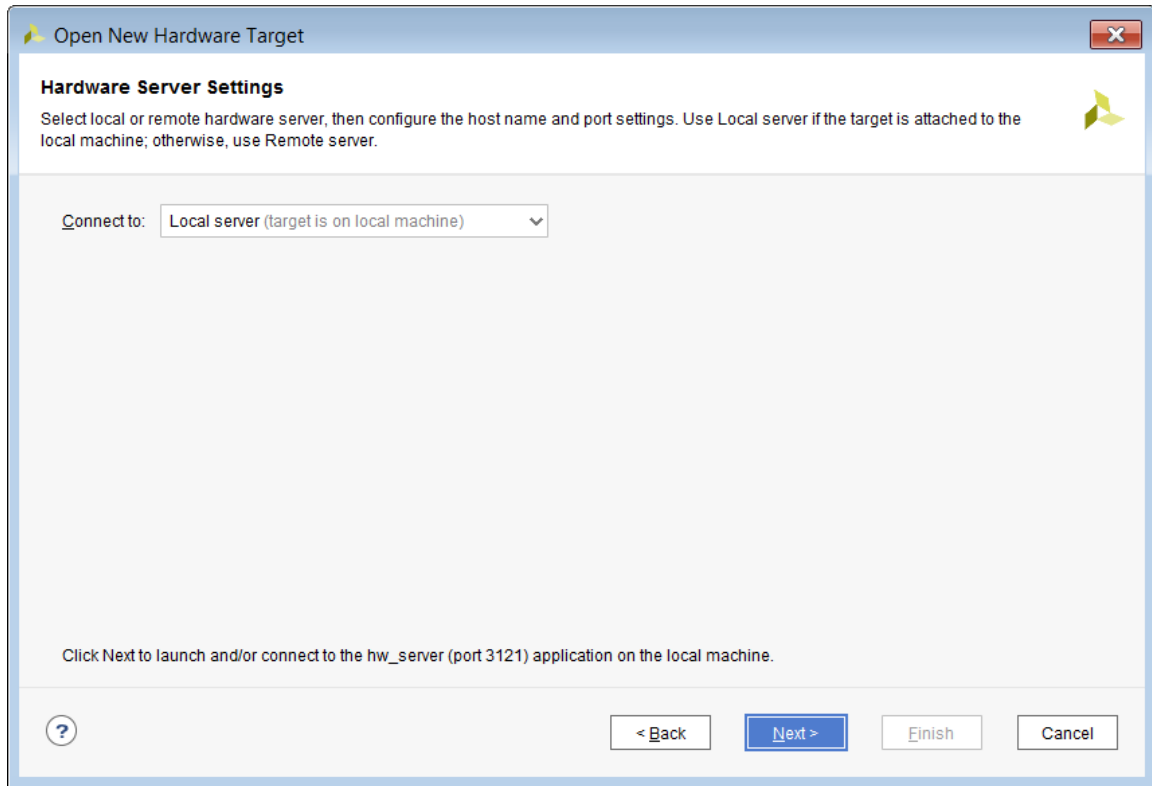

3. In the Select Hardware Target page, and click **Next**.

There is only one target board in this case to connect to, so that the default is selected.

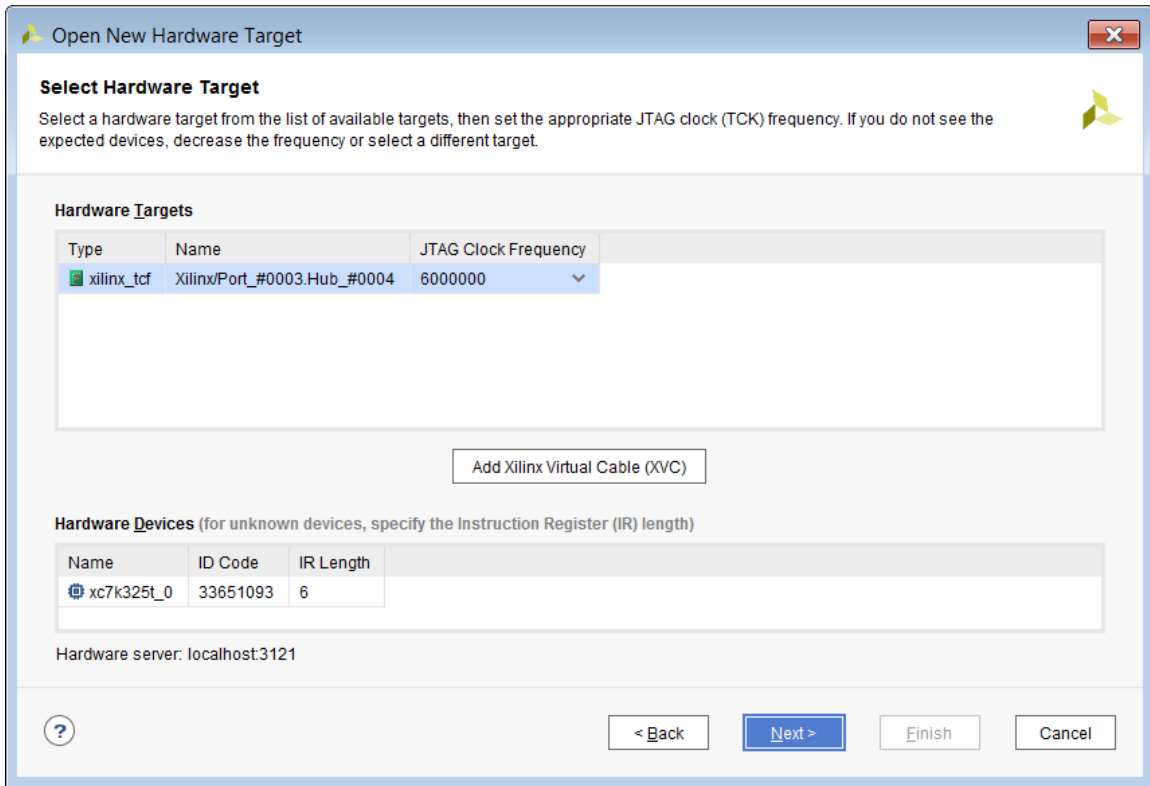

- In the Open Hardware Target Summary page, review the options that you selected. Click **Finish**.

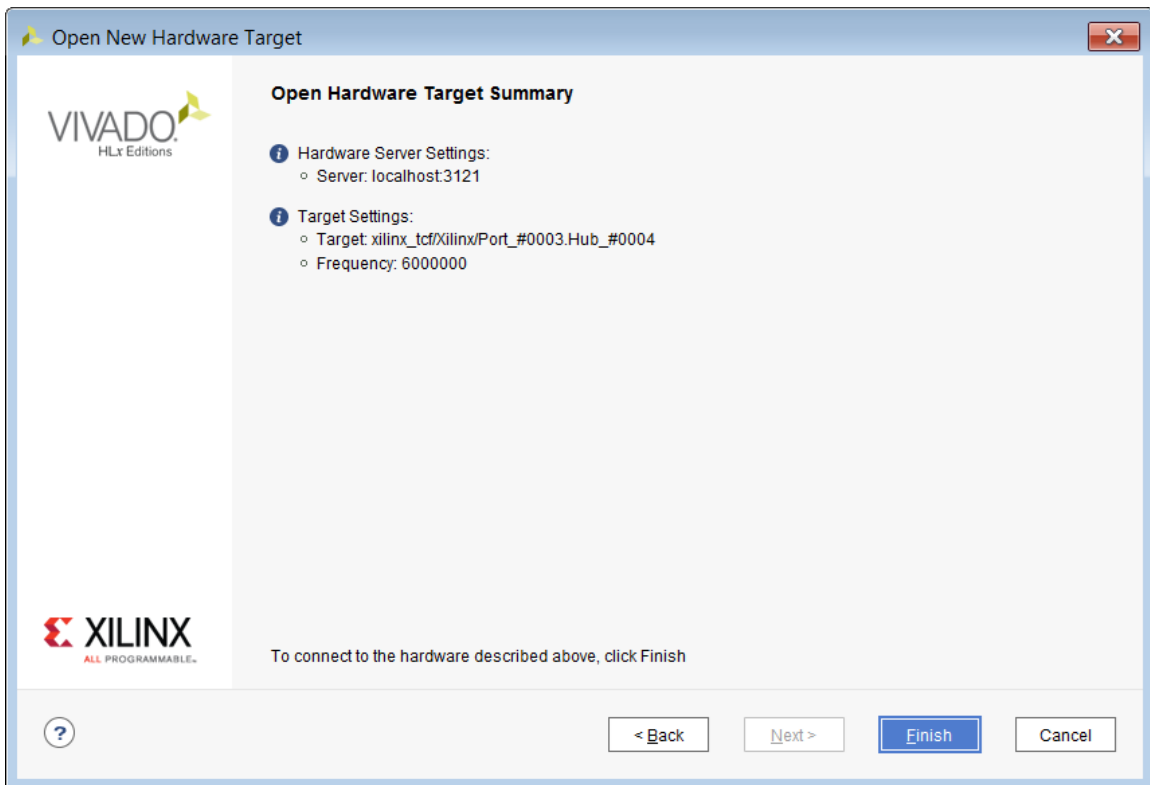

- The Hardware window in Vivado IDE should show the status of the target FPGA on the KC705 board.

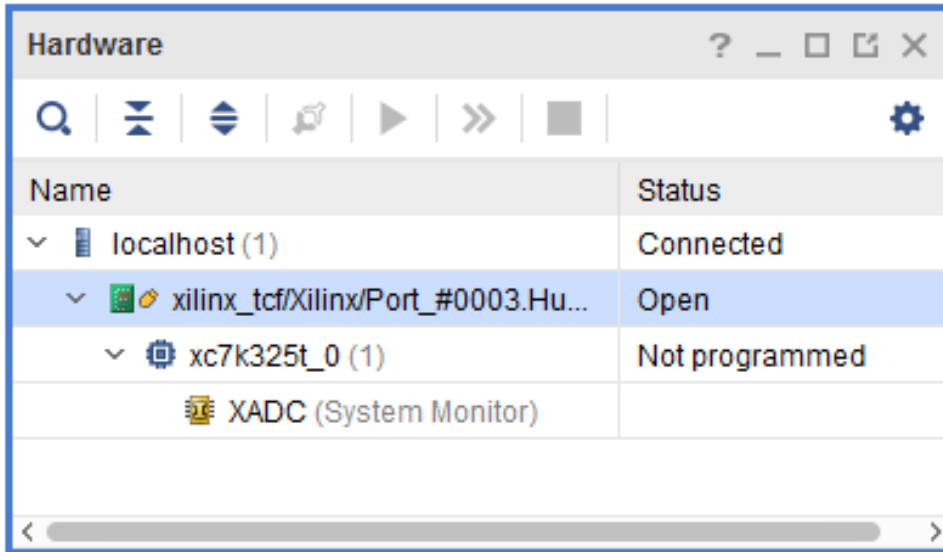

- Select **XC7K325T\_0(0)** in the Hardware window, right-click and select **Program Device**.

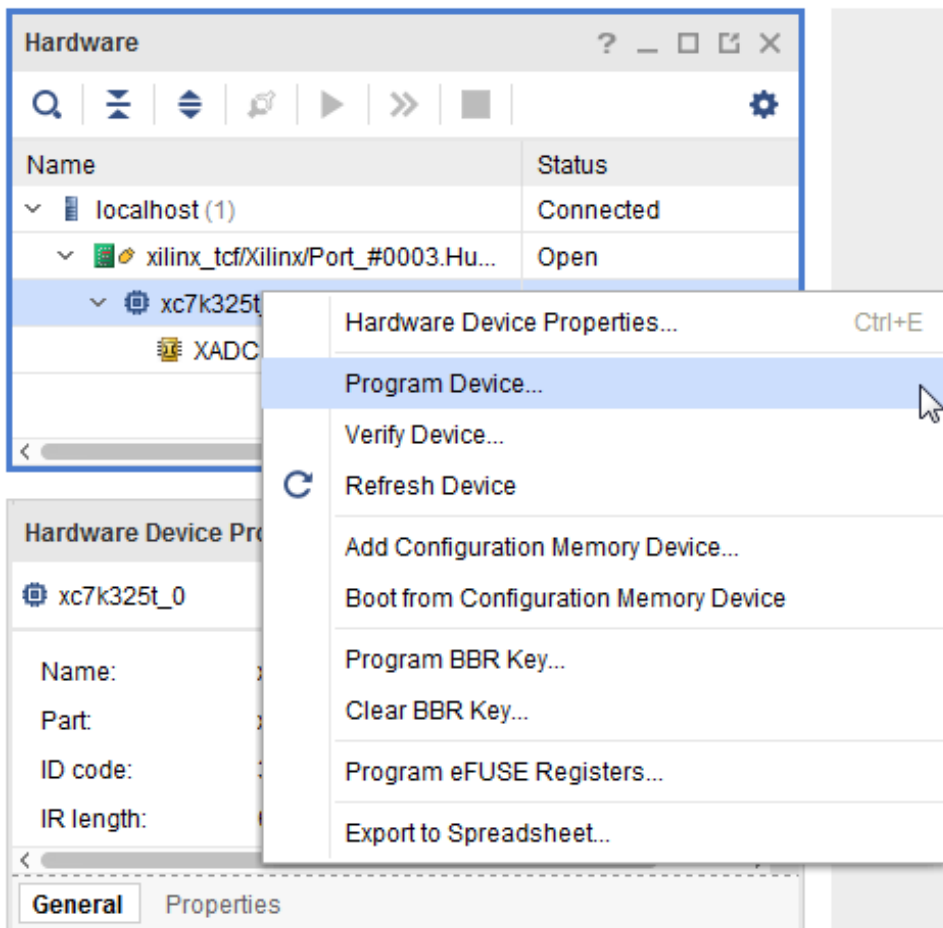

- The Program Device dialog box opens. Make sure that the correct .bit file is selected, and click **Program**.

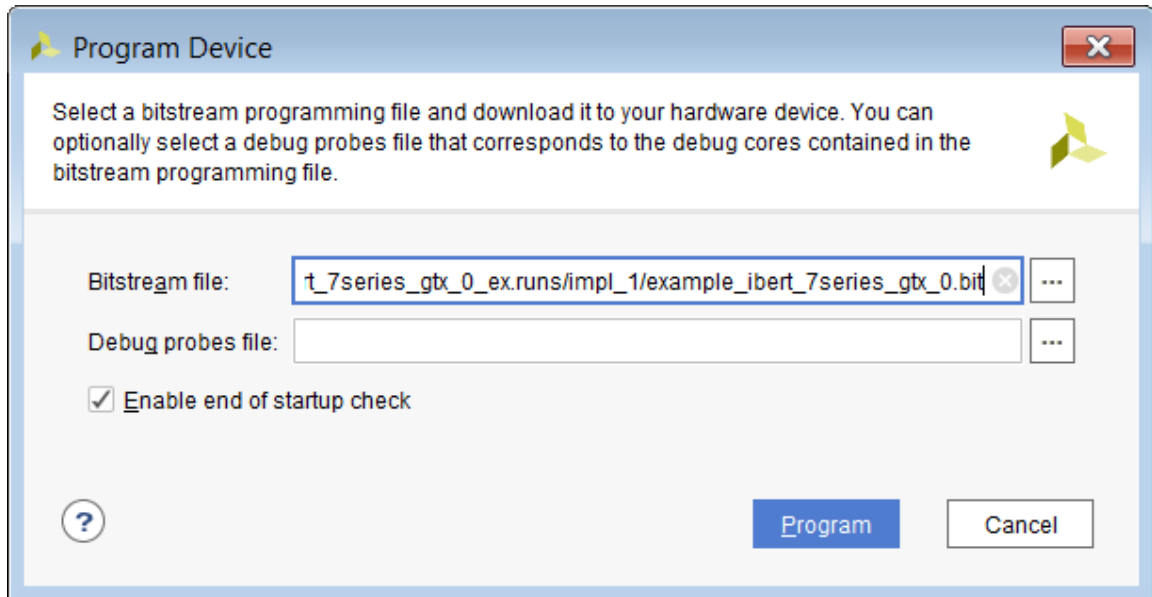

- The Hardware window now shows the IBERT IP that you customized and implemented from the previous steps. It contains two QUADS each of which has four GTX transceivers. These components of the IBERT were detected while scanning the device after downloading the bitstream. If you do not see the QUADS then select the **XC7K325 device**, right-click and select **Refresh Device**.

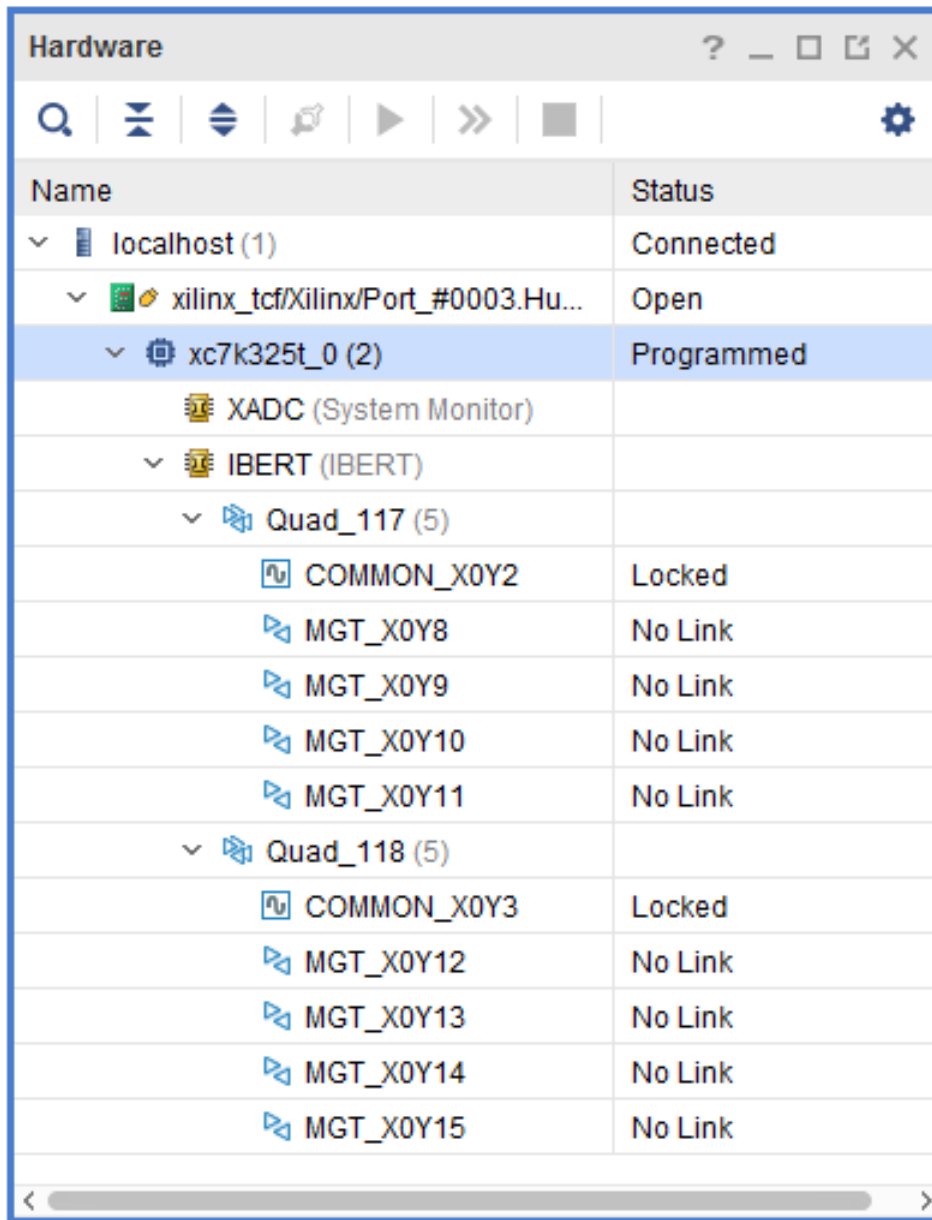

- Next, create links for all eight transceivers. Vivado Serial I/O analyzer is a link-based analyzer, which allows users to link between any transmitter and receiver GTs within the IBERT design. For this tutorial, simply link the TX and RX of the same channel. To create a link, right-click the **IBERT Core** in the Hardware window and click **Create Links**.

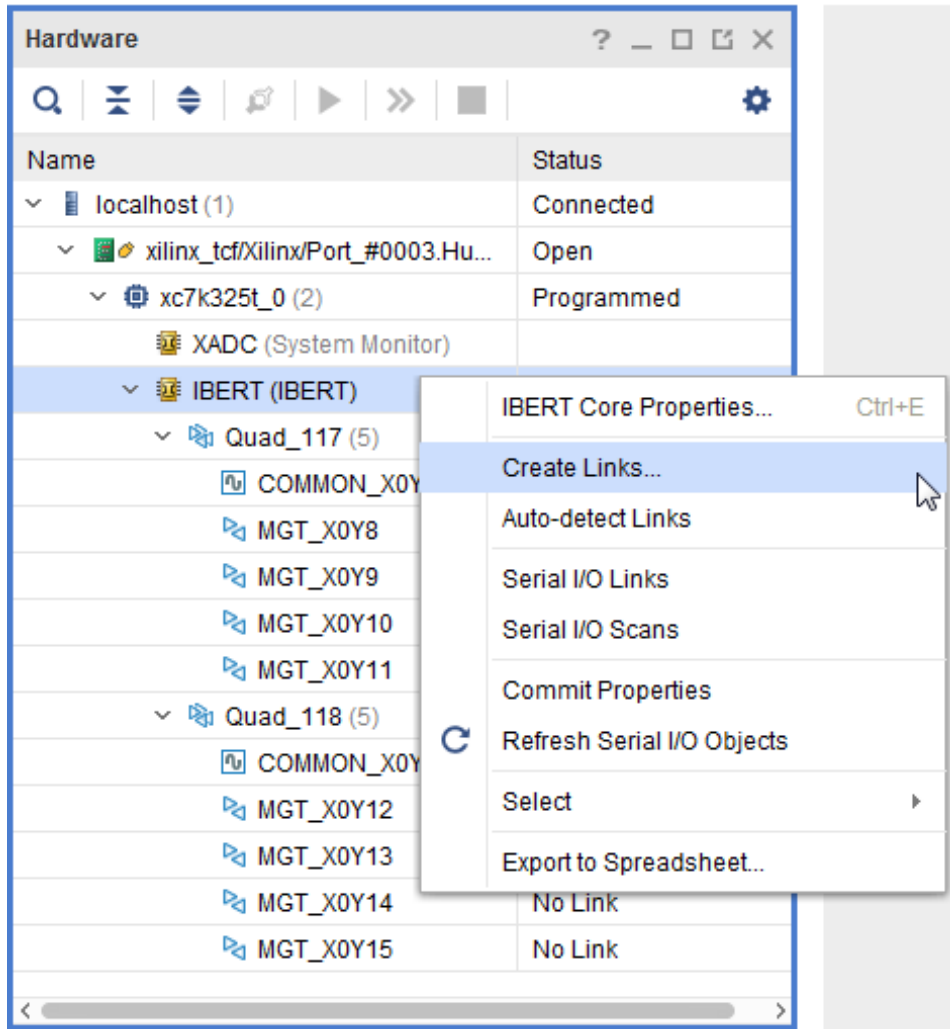

The Create Links dialog box opens.

10. Ensure the first transceiver pairs (MGT\_X0Y8/TX and MGT\_X0Y8/RX) are selected.

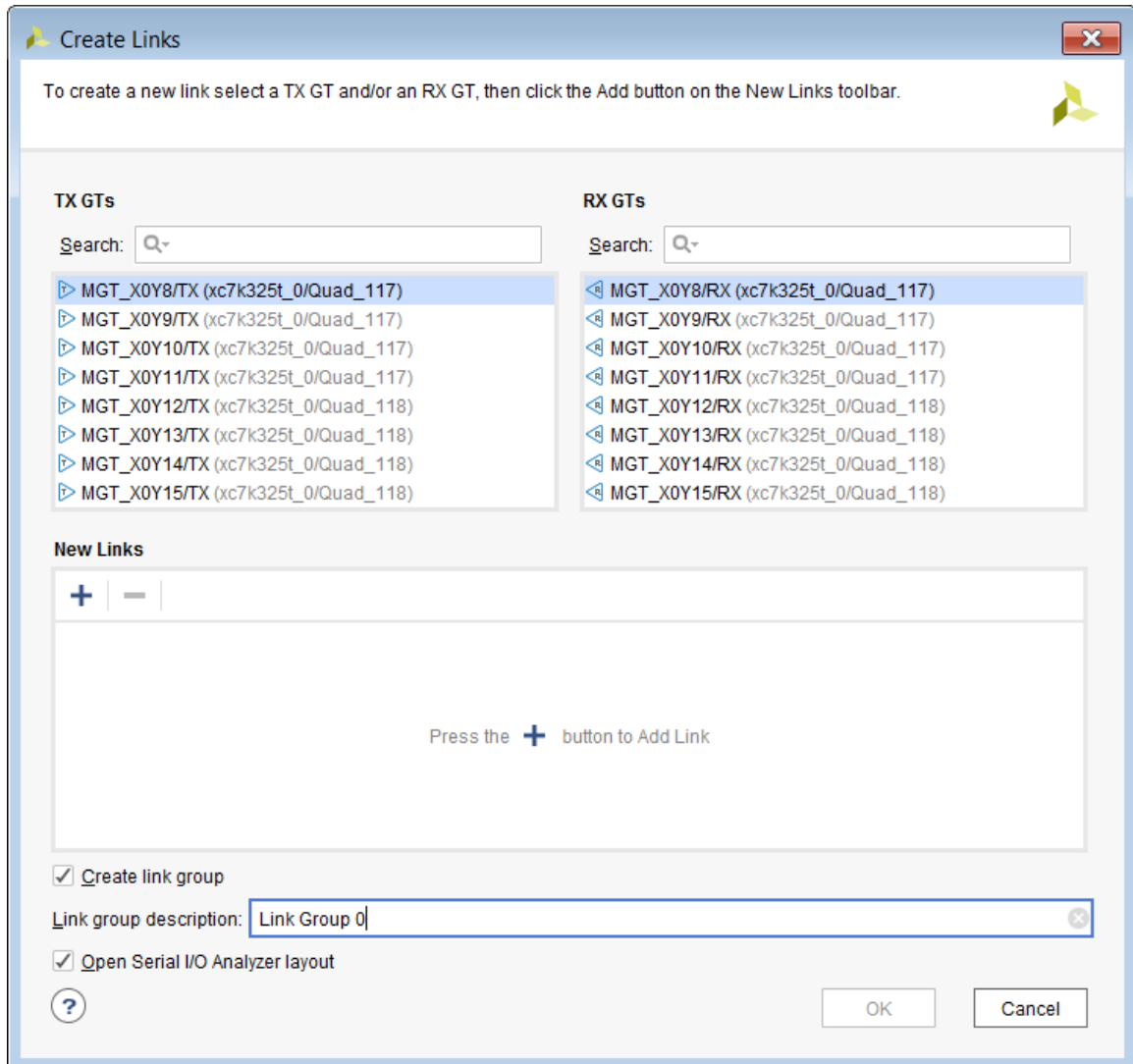

11. Click the “+” button add a new link. In the Link group description field, type Link Group SMA. Select the **Internal Loopback** check box.

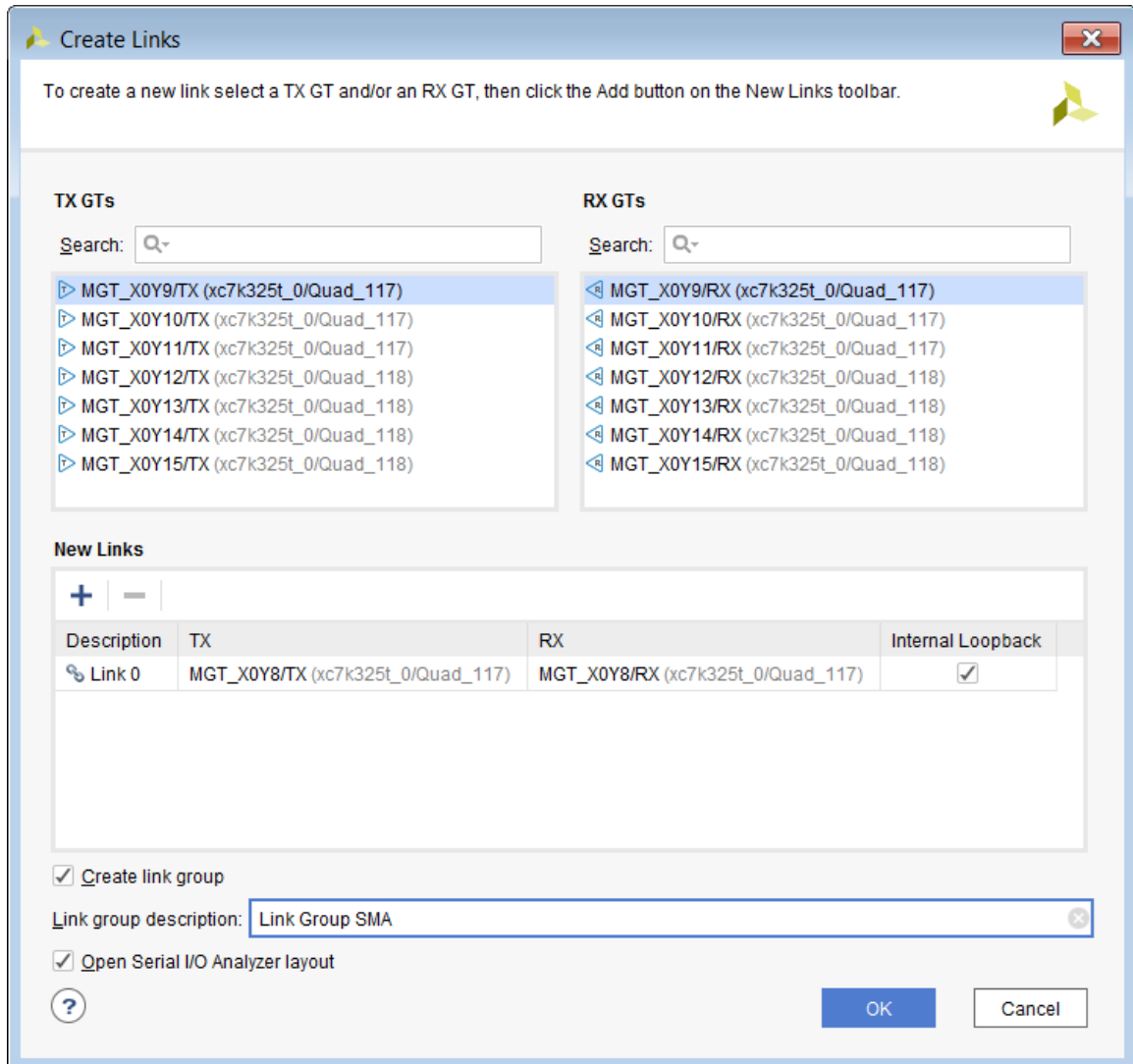

For the first link group, call this Link Group SMA as this is the only transceiver channel that is linked through the SMA cables. The new link shows up in the Links window.

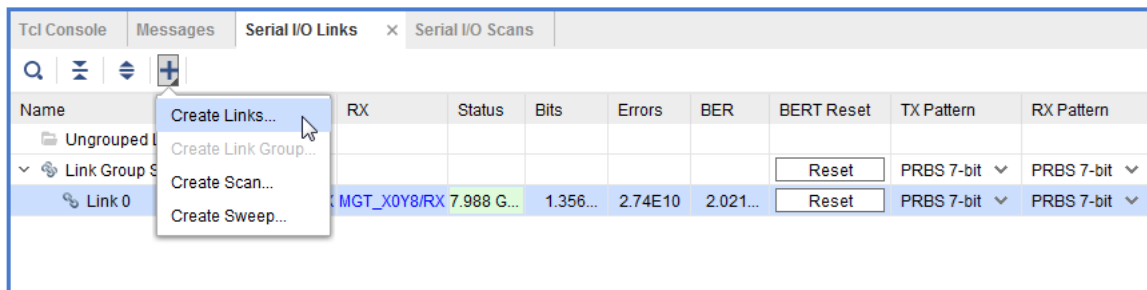

12. Click **Create Link** again to create link groups for the rest of the transceiver pairs. To do this ensure that the transceiver pairs are selected, and click the + sign icon (add new link) repeatedly, until all the links have been added to the new link group called Link Group Internal Loopback. Click **OK**.



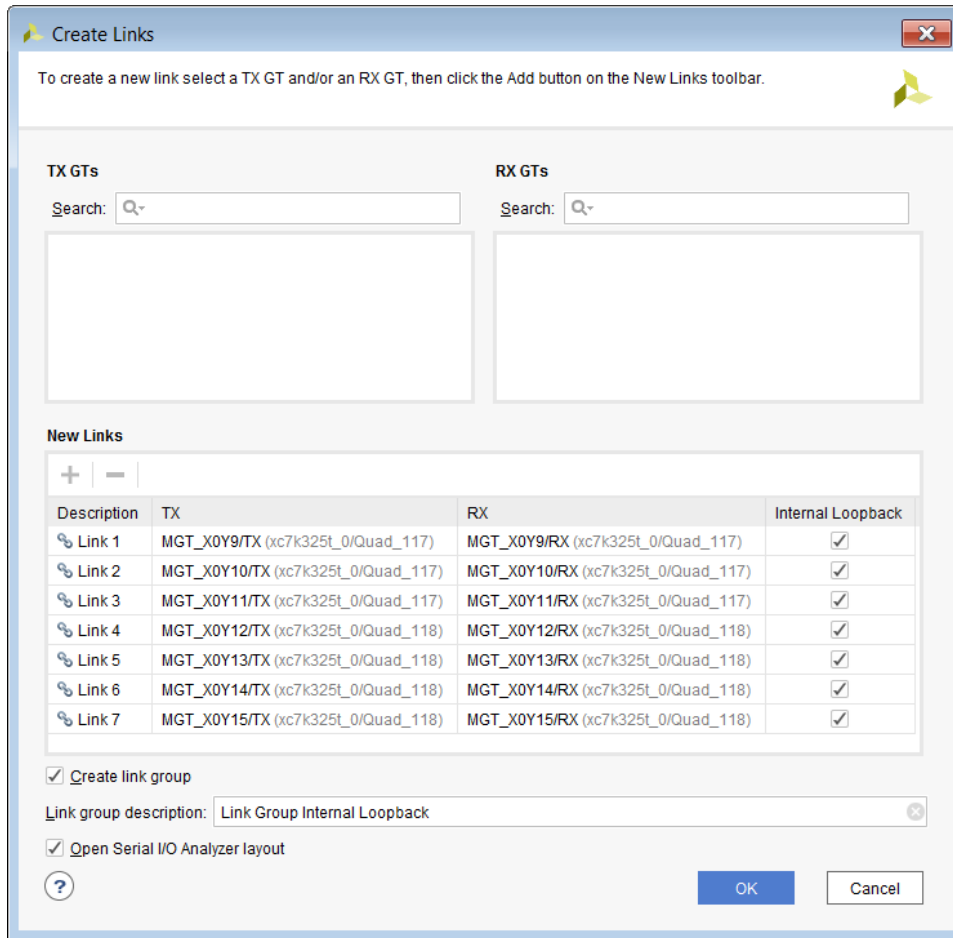

13. After the links have been created, they are added to the Links window as shown.

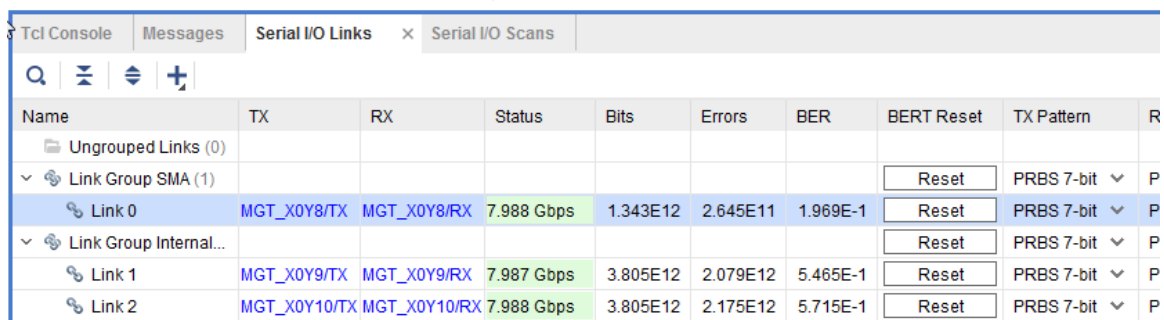

The status of the links indicate an 8.0 Gbps line rate.

For more information about the different columns of the Links windows, see the *Vivado Design Suite User Guide: Programming and Debugging* (UG908).

14. Change the GT properties of the rest of the transceivers as described above.

15. Next, create a 2D scan. Click **Create Scan** in the Links window.

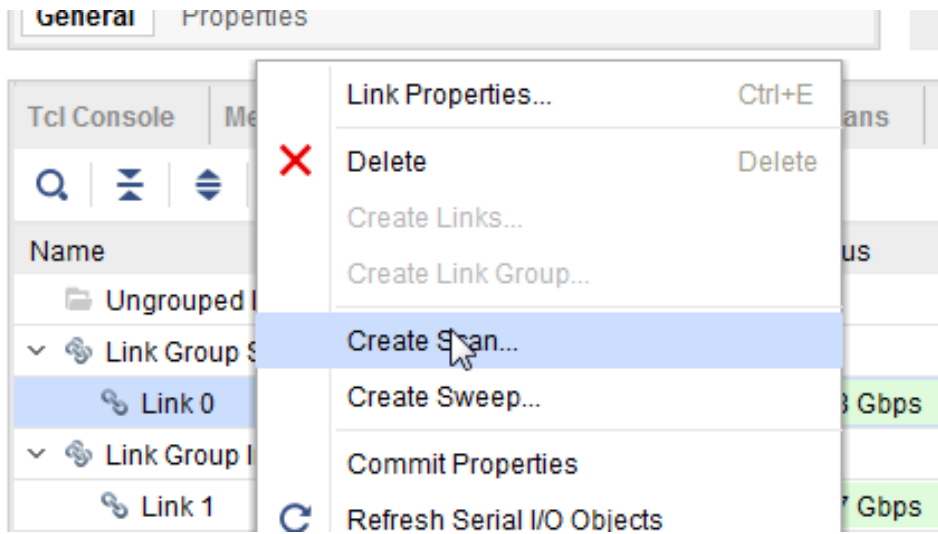

The Create Scan dialog box opens. In this dialog box, you can change the various scan properties. In this case, leave everything to its default value and click **OK**. For more information on the scan properties, see *Vivado Design Suite User Guide: Programming and Debugging* ([UG908](#)).

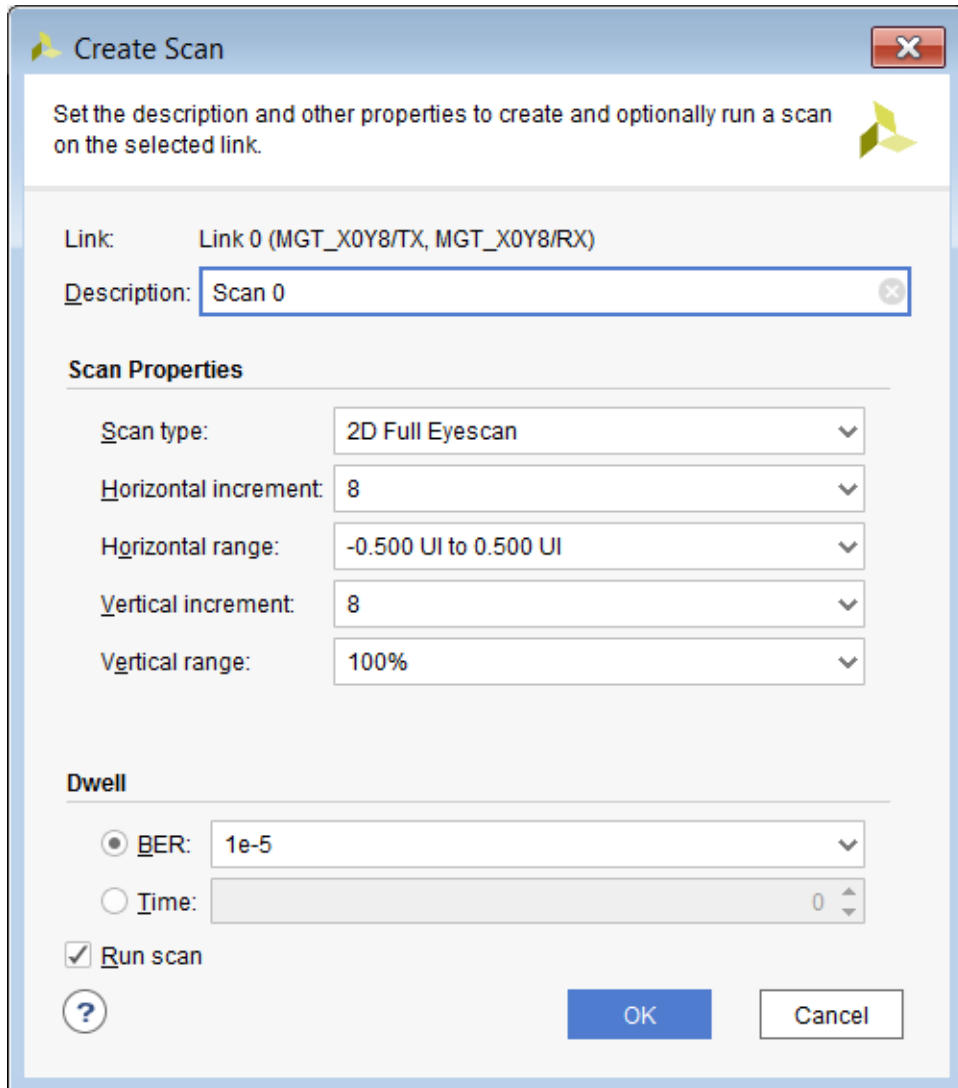

The Scan Plot window opens as shown in the following figure.

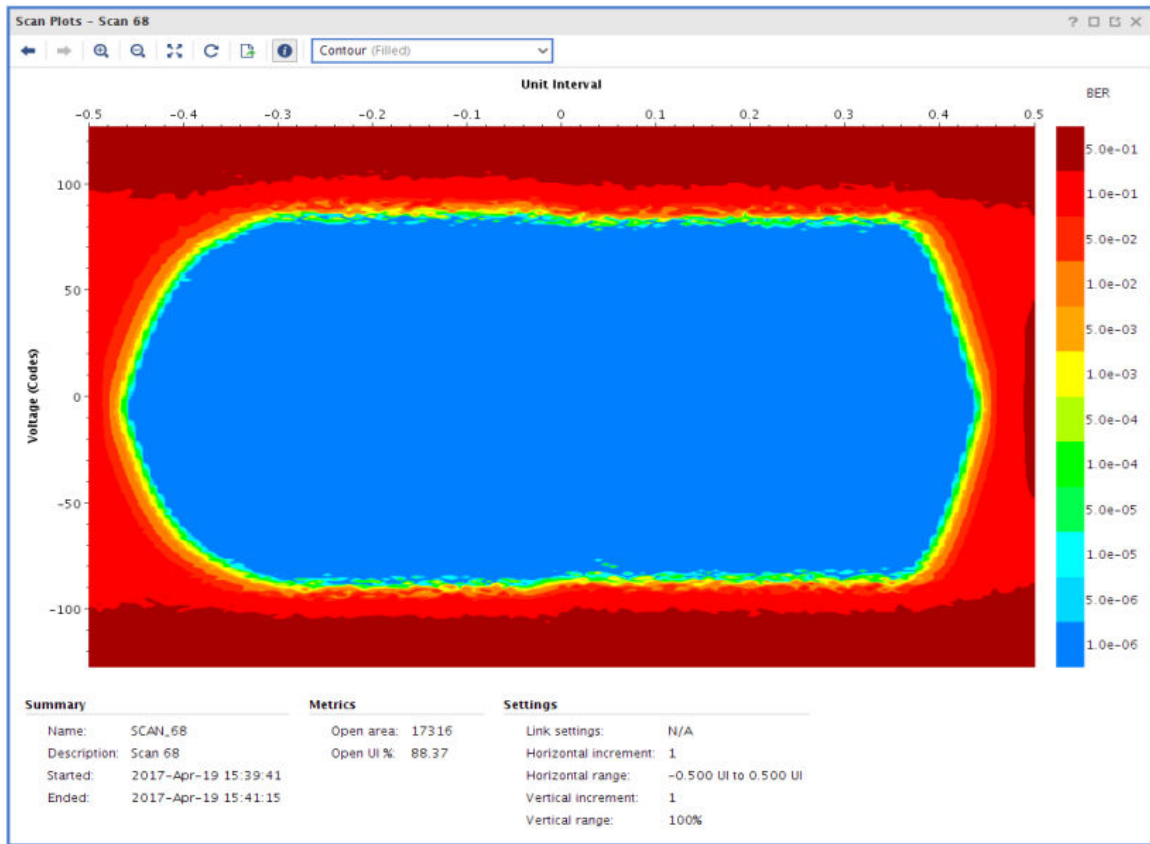

The 2D Scan Plot is a heat map of the BER value.

You can also perform a Sweep test on the links that you created earlier.

16. In the Links window, highlight Link 0 under the Link called Link Group SMA, right-click and select **Create Sweep**.

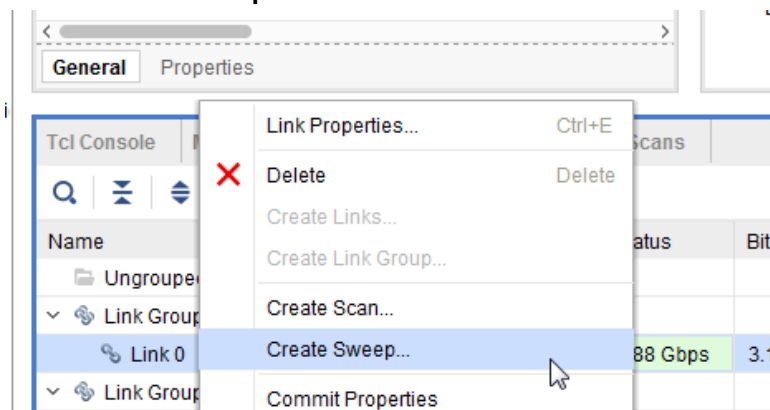

17. The Create Sweep dialog box opens, as shown below. Various properties for the Sweep test can be changed in this dialog box. Leave all the values to its default state and click **OK**.

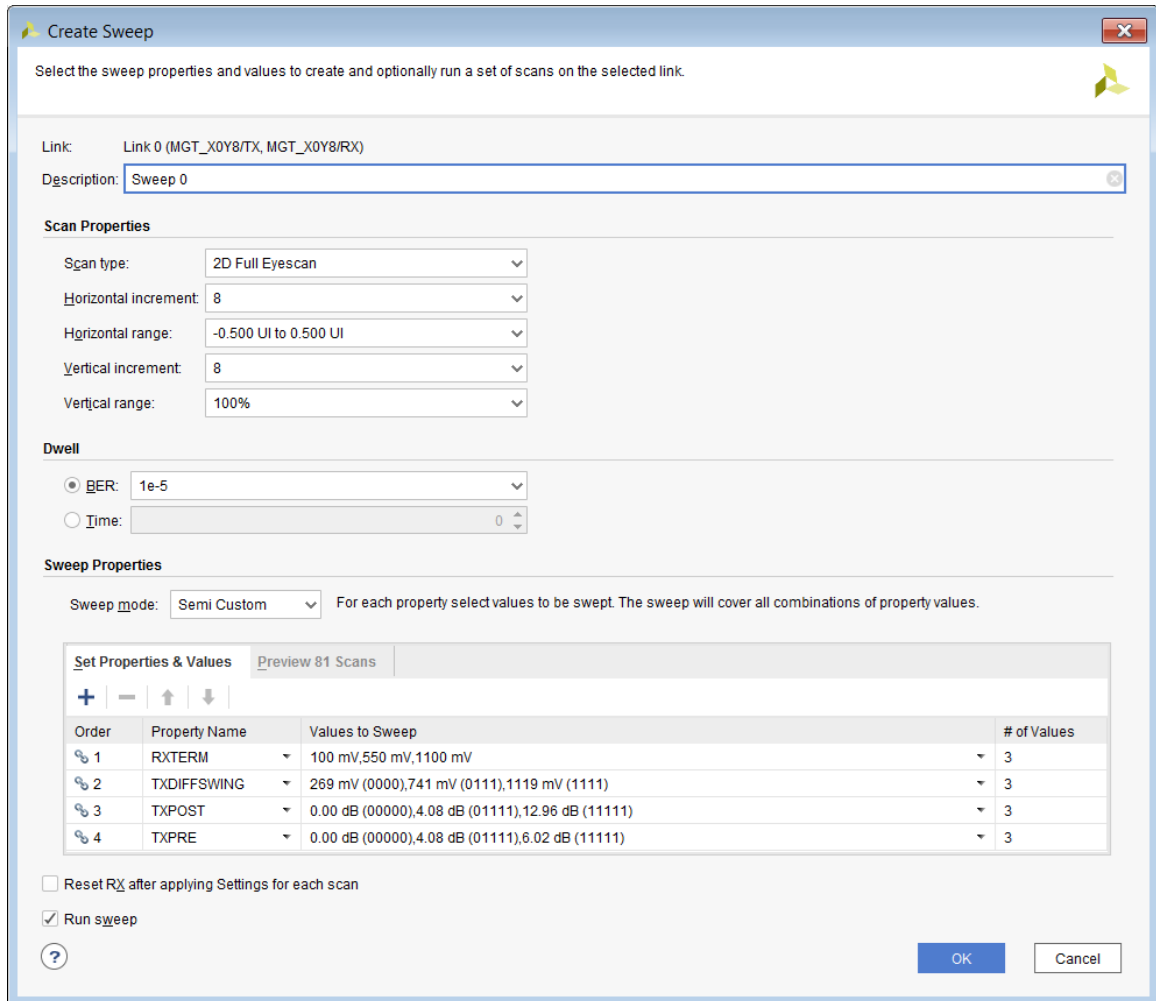

Because here are four different Sweep Properties and each of these properties has three different values (as seen in the Values to Sweep column), a total number of 81 sweep tests are carried out. The Scans window shows the results of all the scans that have been done for the selected link.



**CAUTION!** Since there are 81 scans to be done, it could be a few minutes before all the scans are complete.

Name	Link	Link Settings	Reset RX	Scan Type	Status	Progress	Open Area	Open UI %	Horiz Incr	Horiz Range
Sweep 0 - Scan 2	RXTERM (100 mV)	TXDIFFSWING (269 mV (0000)) TXPOST (0.00 dB (00000)) TXPRE (...)	<input type="checkbox"/>	2d_full_eye	Done	100%	10176	77.78	8	-0.500 UI to 0.500 UI
Sweep 0 - Scan 3	RXTERM (100 mV)	TXDIFFSWING (269 mV (0000)) TXPOST (0.00 dB (00000)) TXPRE (...)	<input type="checkbox"/>	2d_full_eye	Done	100%	10240	77.78	8	-0.500 UI to 0.500 UI
Sweep 0 - Scan 4	RXTERM (100 mV)	TXDIFFSWING (269 mV (0000)) TXPOST (0.00 dB (00000)) TXPRE (...)	<input type="checkbox"/>	2d_full_eye	Done	100%	10112	77.78	8	-0.500 UI to 0.500 UI
Sweep 0 - Scan 5	RXTERM (100 mV)	TXDIFFSWING (269 mV (0000)) TXPOST (4.08 dB (01111)) TXPRE (...)	<input type="checkbox"/>	2d_full_eye	Done	100%	10176	77.78	8	-0.500 UI to 0.500 UI
Sweep 0 - Scan 6	RXTERM (100 mV)	TXDIFFSWING (269 mV (0000)) TXPOST (4.08 dB (01111)) TXPRE (...)	<input type="checkbox"/>	2d_full_eye	Done	100%	10240	77.78	8	-0.500 UI to 0.500 UI
Sweep 0 - Scan 7	RXTERM (100 mV)	TXDIFFSWING (269 mV (0000)) TXPOST (4.08 dB (01111)) TXPRE (...)	<input type="checkbox"/>	2d_full_eye	Done	100%	10240	77.78	8	-0.500 UI to 0.500 UI
Sweep 0 - Scan 8	RXTERM (100 mV)	TXDIFFSWING (269 mV (0000)) TXPOST (12.96 dB (11111)) TXPRE (...)	<input type="checkbox"/>	2d_full_eye	Done	100%	10112	77.78	8	-0.500 UI to 0.500 UI
Sweep 0 - Scan 9	RXTERM (100 mV)	TXDIFFSWING (269 mV (0000)) TXPOST (12.96 dB (11111)) TXPRE (...)	<input type="checkbox"/>	2d_full_eye	Done	100%	10112	77.78	8	-0.500 UI to 0.500 UI
Sweep 0 - Scan 10	RXTERM (100 mV)	TXDIFFSWING (269 mV (0000)) TXPOST (12.96 dB (11111)) TXPRE (...)	<input type="checkbox"/>	2d_full_eye	Done	100%	10240	77.78	8	-0.500 UI to 0.500 UI
Sweep 0 - Scan 11	RXTERM (100 mV)	TXDIFFSWING (741 mV (0111)) TXPOST (0.00 dB (00000)) TXPRE (...)	<input type="checkbox"/>	2d_full_eye	Done	100%	10240	77.78	8	-0.500 UI to 0.500 UI
Sweep 0 - Scan 12	RXTERM (100 mV)	TXDIFFSWING (741 mV (0111)) TXPOST (0.00 dB (00000)) TXPRE (...)	<input type="checkbox"/>	2d_full_eye	Done	100%	10112	77.78	8	-0.500 UI to 0.500 UI

To see the results of any of the scans that have been performed, highlight the scan, right-click, and select **Display Scan Plots**.

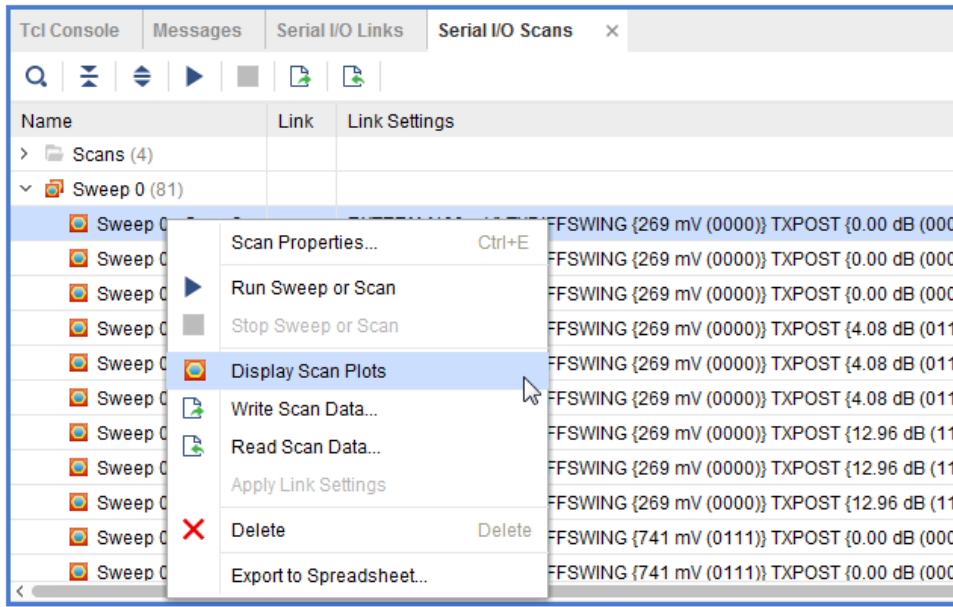

The Scan Plots window opens showing the details of the scan performed.

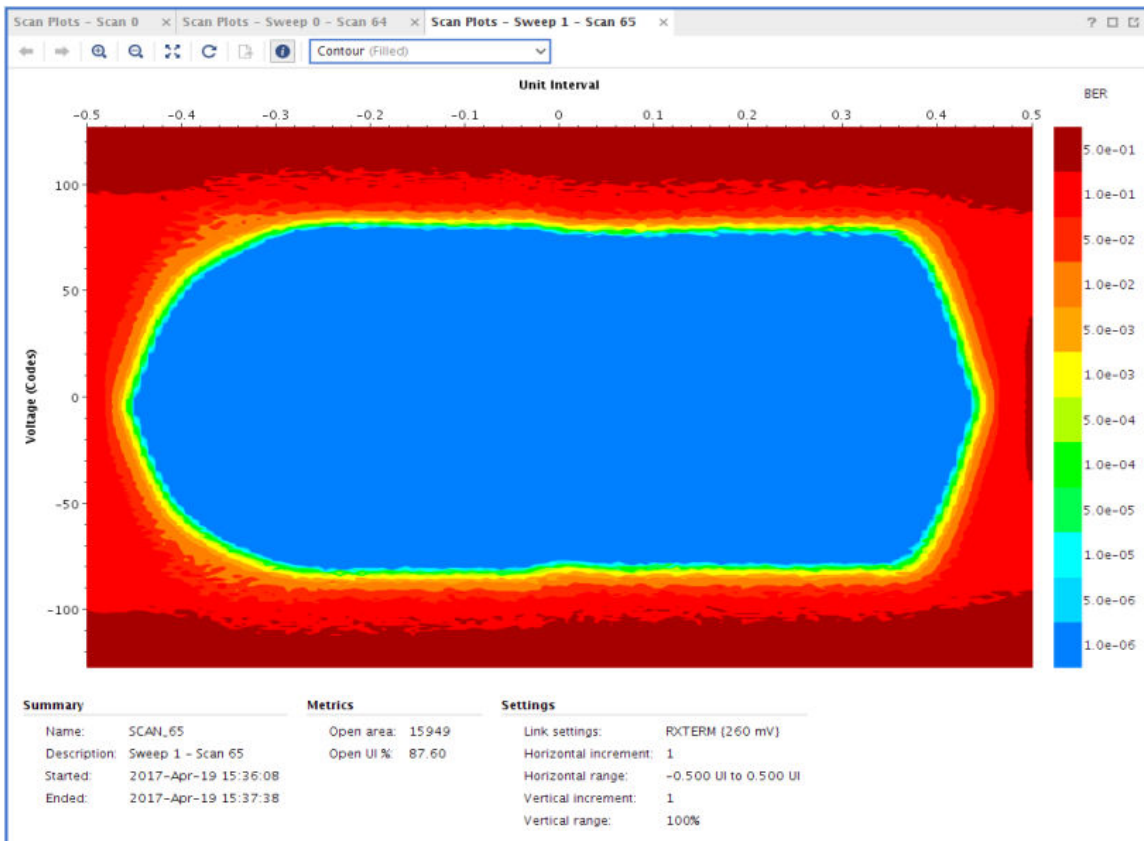

# Using the Vivado ILA Core to Debug JTAG-AXI Transactions

This lab illustrates how to insert an ILA core into the JTAG to AXI Master IP core example design, using the ILA's advanced trigger and capture capabilities.

## What is the JTAG to AXI Master IP core?

The LogiCORE™ LogiCORE IP JTAG-AXI core is a customizable core that can generate AXI transactions and drive AXI signals internal to the FPGA at run-time. This supports all memory-mapped AXI interfaces (except AXI4-Stream) and Lite protocol and can be selected using a parameter. The width of the AXI data bus is customizable. This IP can drive any AXI4-Lite or Memory-Mapped Slave directly. It can also be connected as master to the interconnect. Run-time interaction with this core requires the use of the Vivado® logic analyzer feature.

## Key Features

- AXI4 master interface
- Option to select AXI4 and AXI4-Lite interfaces
- User controllable AXI read and write enable
- User Selectable AXI data width: 32 and 64
- Vivado Integrated Logic Analyzer Tcl Console interface to interact with hardware

## Additional Documentation

*JTAG to AXI Master LogiCORE IP Product Guide* ([PG174](#)) contains additional information

---

## Design Description

This section has three steps as follows:

1. Creating a simple design in IP integrator that includes a System ILA and JTAG-to-AXI master.
2. Programming the Kintex®-7 FPGA KC705 Evaluation Kit Base Board and interacting with the JTAG to AXI Master IP core.

3. Using the ILA Advanced Trigger Feature to Trigger on an AXI Read Transaction.

---

## Step 1: Creating a New Vivado Project and Generating the IP Integrator Design with JTAG-to-AXI and System ILA

To create a project, use the New Project wizard to name the project, add RTL source files and constraints, and specify the target device.

1. Invoke the Vivado® IDE.
2. In the Quick Start tab, click **Create Project** to start the New Project wizard. Click **Next**.
3. In the Project Name page, name the new project `jtag_2_axi_tutorial` and provide the project location (`C:/jtag_2_axi_tutorial`). Ensure that **Create Project Subdirectory** is selected. Click **Next**.
4. In the Project Type page, specify the Type of Project to create as RTL Project. Ensure that Do not specify sources at this time is checked. Click **Next**.
5. In the Default Part page, choose **Boards** and choose the **Kintex-7 KC705 Evaluation Platform**. Click **Next**.



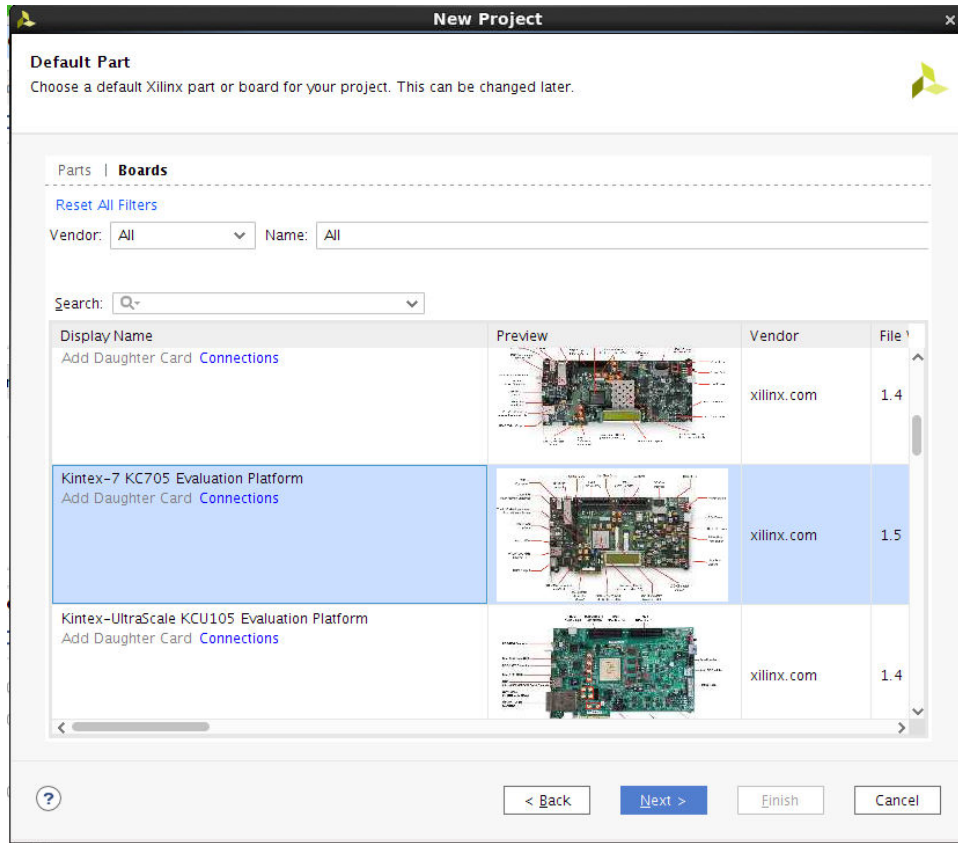

6. In the New Project Summary page, click **Finish**.

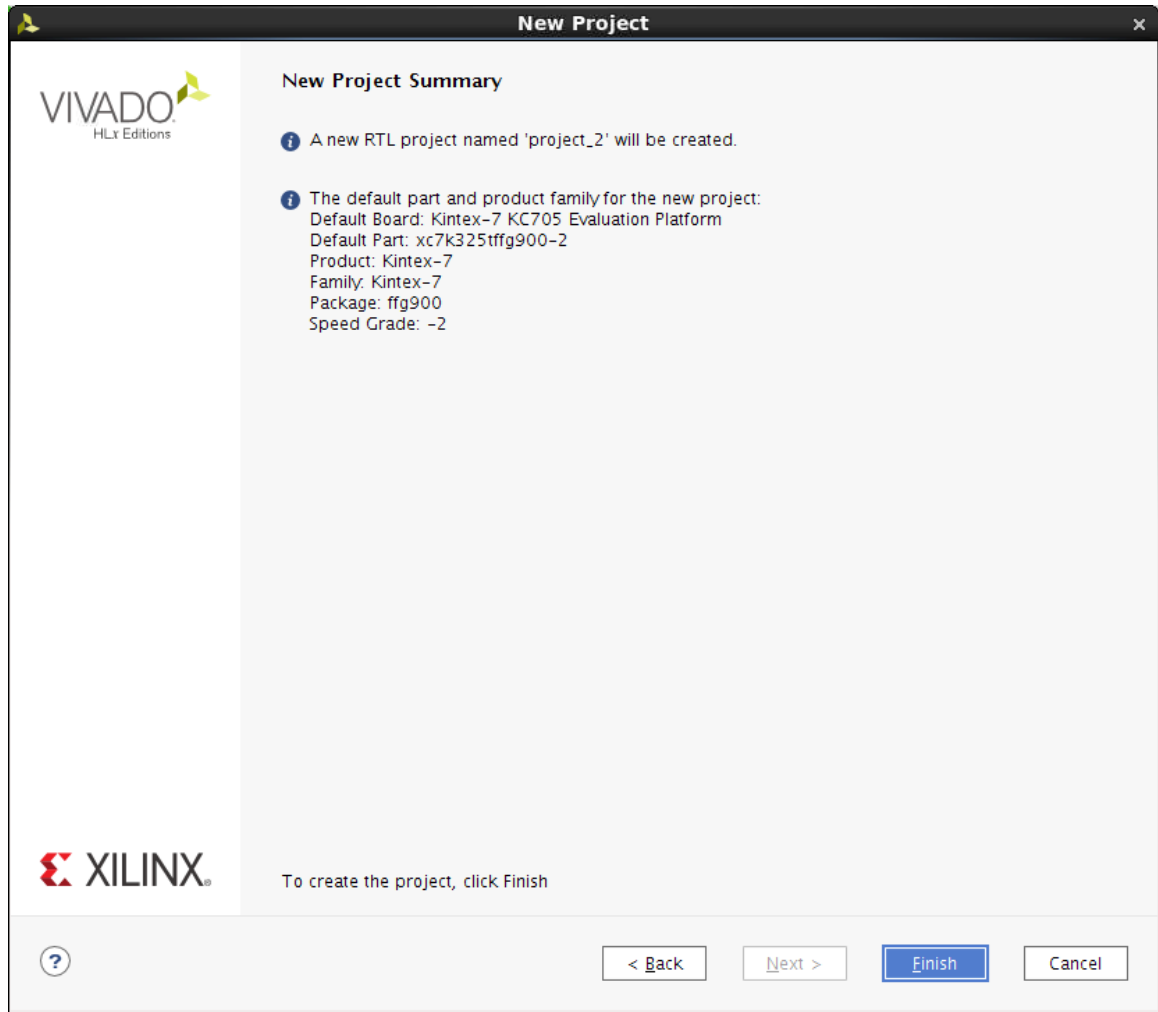

7. In the leftmost panel of the Flow Navigator under Project Manager, click **Create Block Diagram**. A dialog box appears that allows you to specify a block diagram name. You can choose to specify a custom name or take the default. Click **OK**.

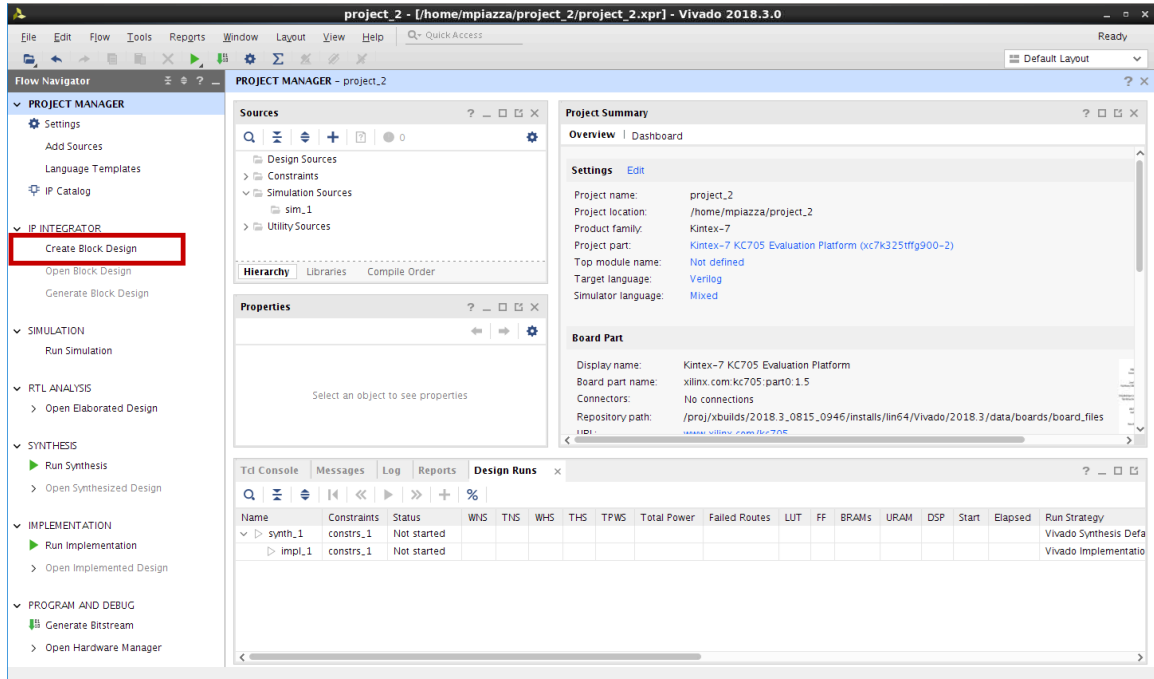

- In the far right of the window is an empty block diagram design window labeled Diagram. Click the + sign in the middle of the pane or the + toolbar button to bring up a search window. In the Search field, type "JTAG to AXI" and double-click it to add the JTAG to AXI Master to the block diagram.

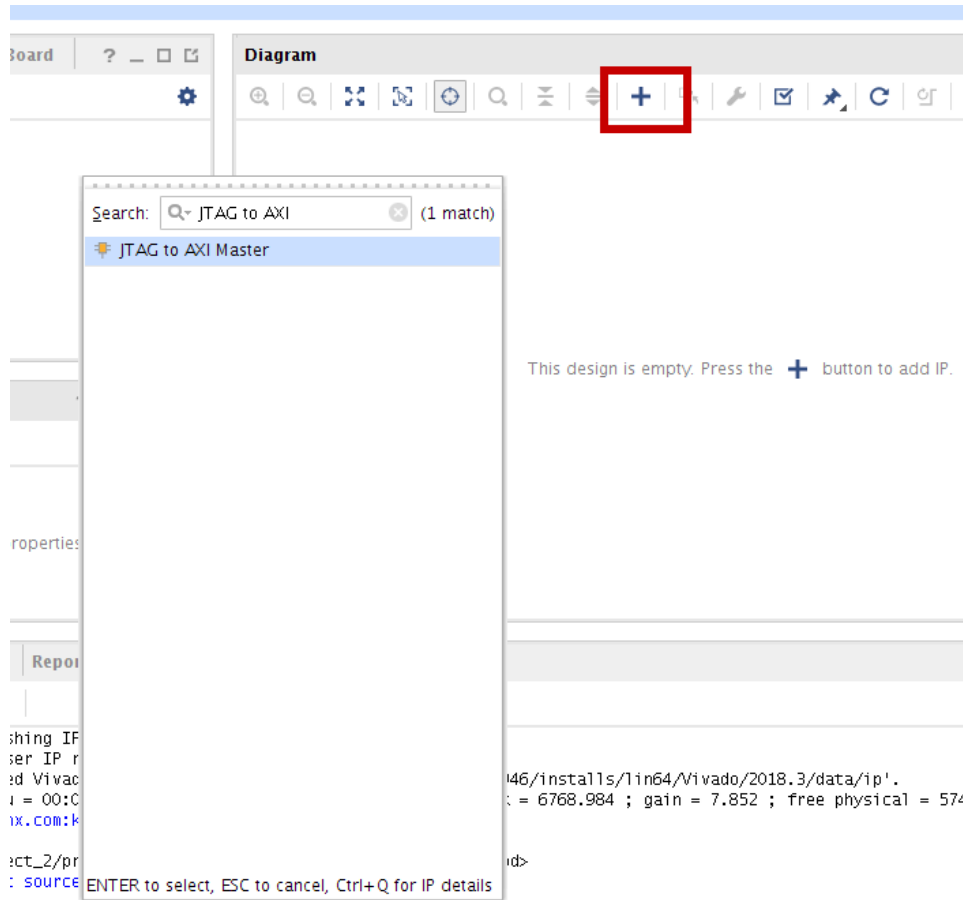

9. The JTAG to AXI Master core appears on the IP integrator canvas. Double-click the core to view the Customization dialog. Review the available settings and click **OK** to accept the default core settings.

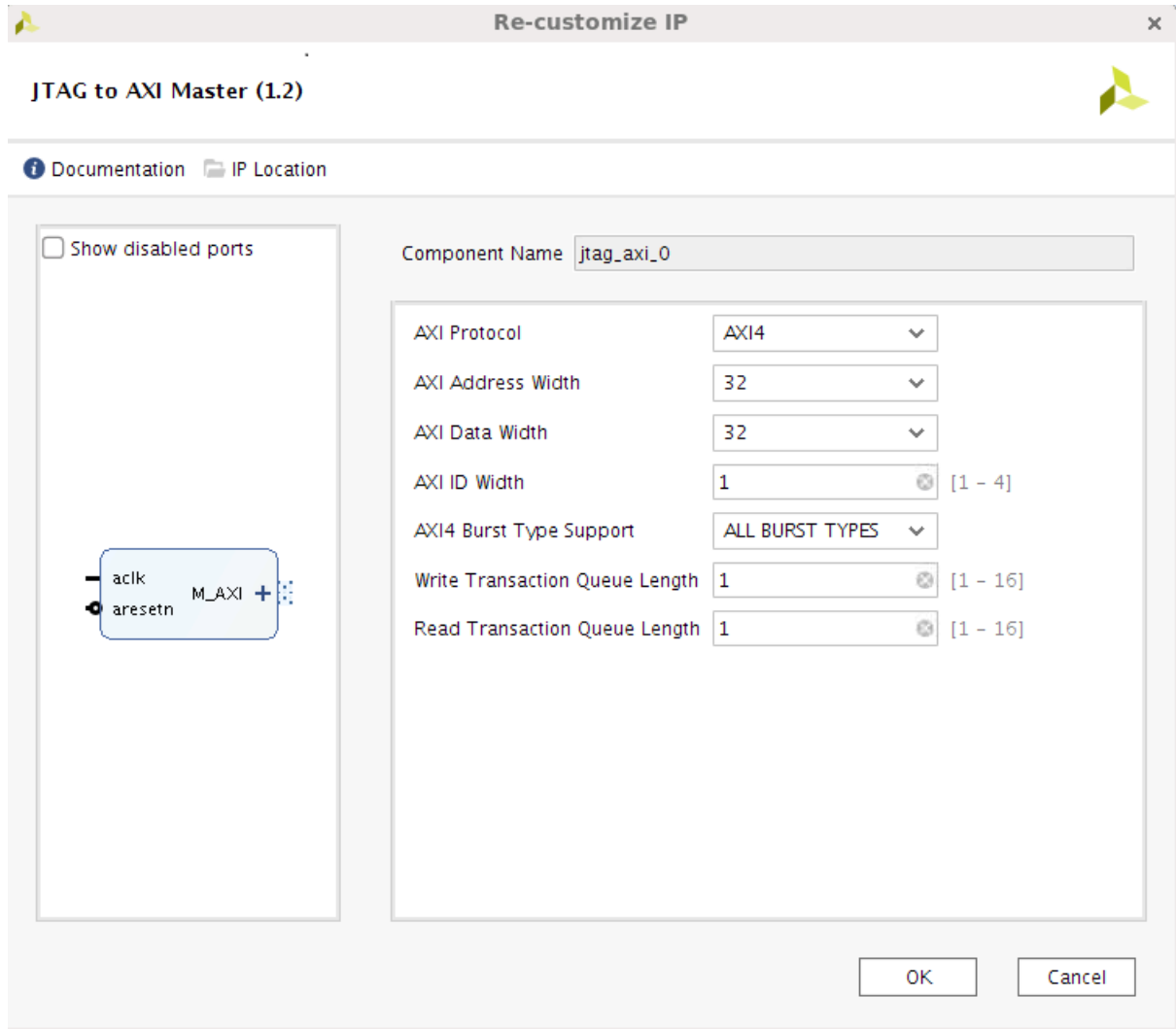

10. Following the same process from the previous step, add the additional IP to the block diagram: AXI BRAM controller and Block Memory Generator. This creates a design using a simple AXI infrastructure to create AXI transactions that demonstrate the debugging capabilities of the System ILA core.
11. Before continuing, you need to customize AXI BRAM Controller and Block Memory Generator. Begin by locating the AXI BRAM Controller in the block diagram canvas and double-clicking on it. This invokes the Customization Dialog for the IP. Locate the Number of BRAM interfaces and set the value to 1. Click **OK**.

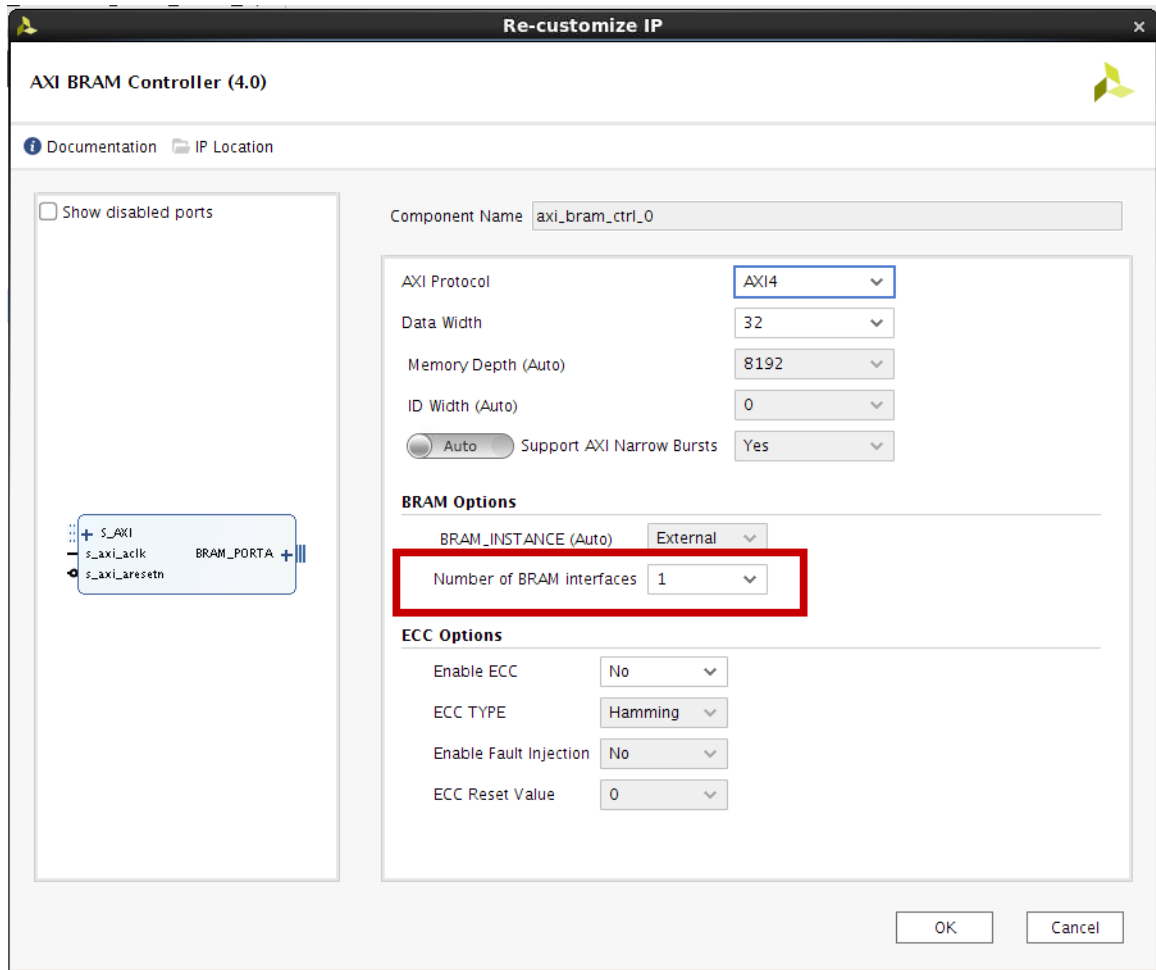

- Next, locate the Block Memory Generator in the block diagram and double-click as in the previous step to invoke the Customization dialog. Clear Enable Safety Circuit check box. Click **OK**.

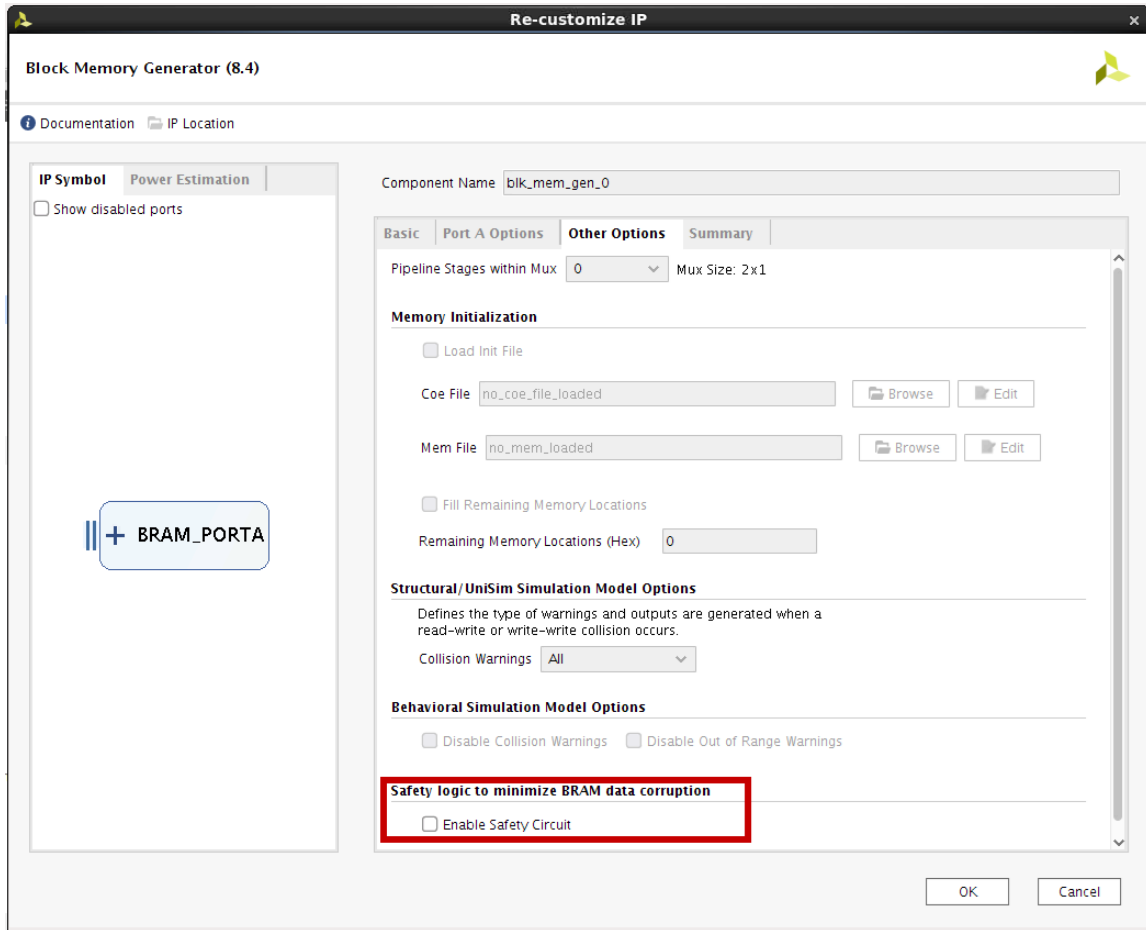

13. At this point the design should look like the following figure.

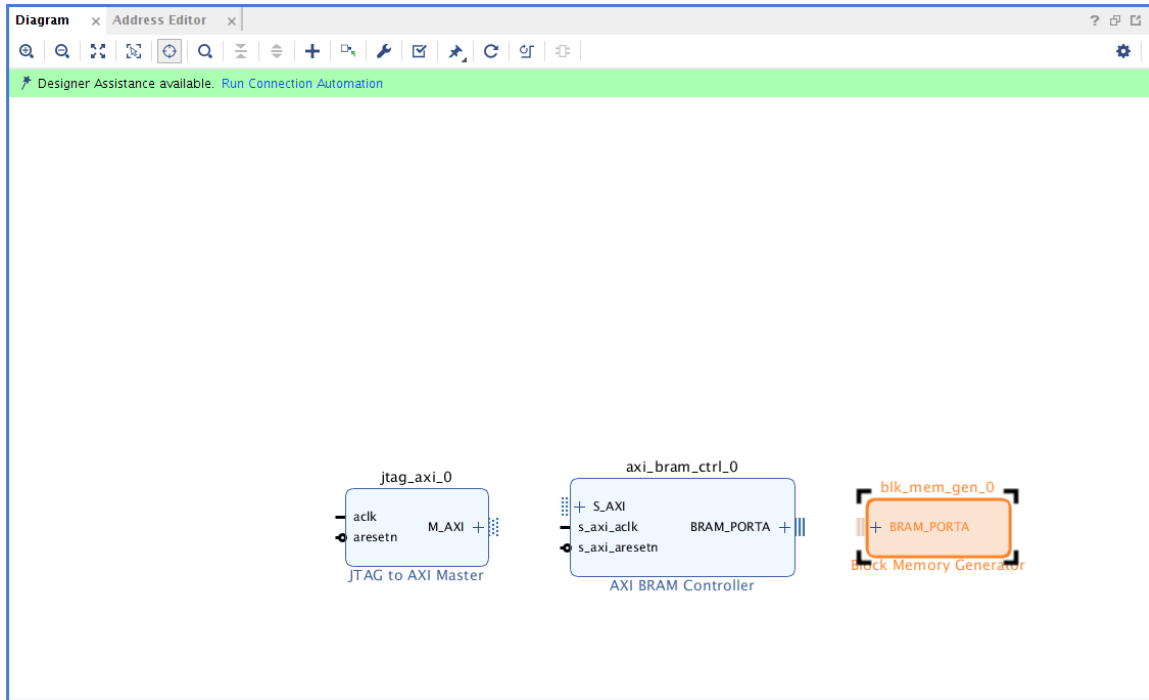

14. Notice the green banner indicating that Designer Assistance is available at the top of the block diagram canvas. Click the **Run Connection Automation** button on this banner. When the Connection Automation window appears, click the radio button for All Automation, then click **OK**.

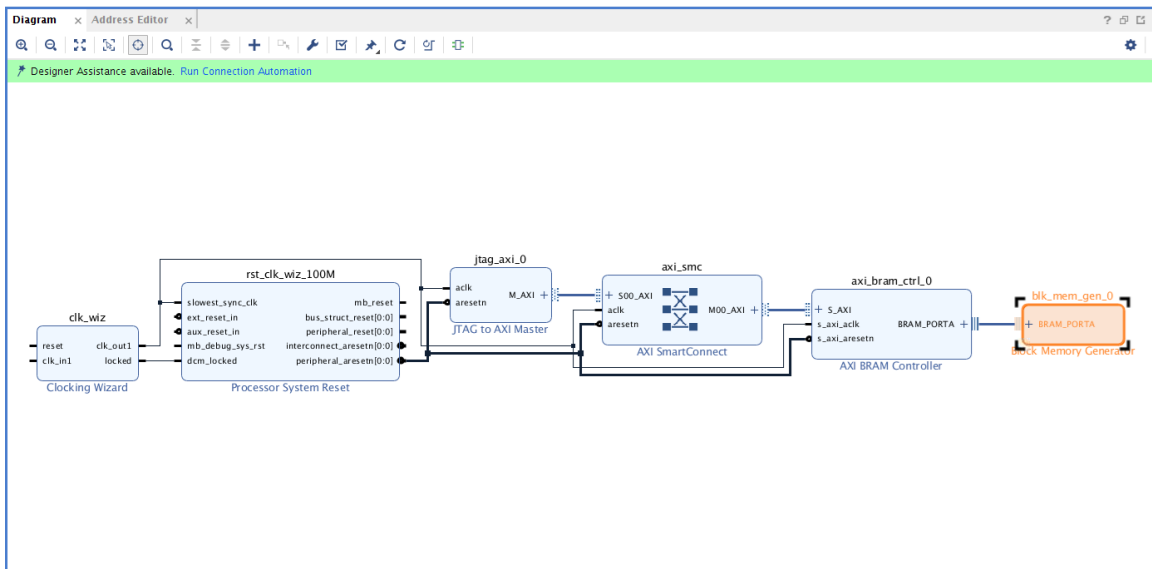

15. Notice, that the Clocking Wizard and Processor System Reset as well as an AXI SmartConnect are auto-inserted into the design. Also, take note that the Clocking Wizard clock and reset inputs are not connected and the Run Connection Automation banner persists. These inputs will be connected to physical input ports on the FPGA, wired to buttons on the KC705 board though customization of the Clocking Wizard.



- Invoke the Customization Dialog for the Clocking Wizard by double-clicking the IP in the block diagram canvas. When the dialog appears, set `CLKIN_1` to `sys_diff_clk` and `EXT_RESET_IN` to `reset`. Click **OK**.

**Note:** It is not necessary to add constraints for these ports because the project has been generated using an evaluation board as the target and the IP allows the constraint information to be selected with the `sys_diff_clk`.

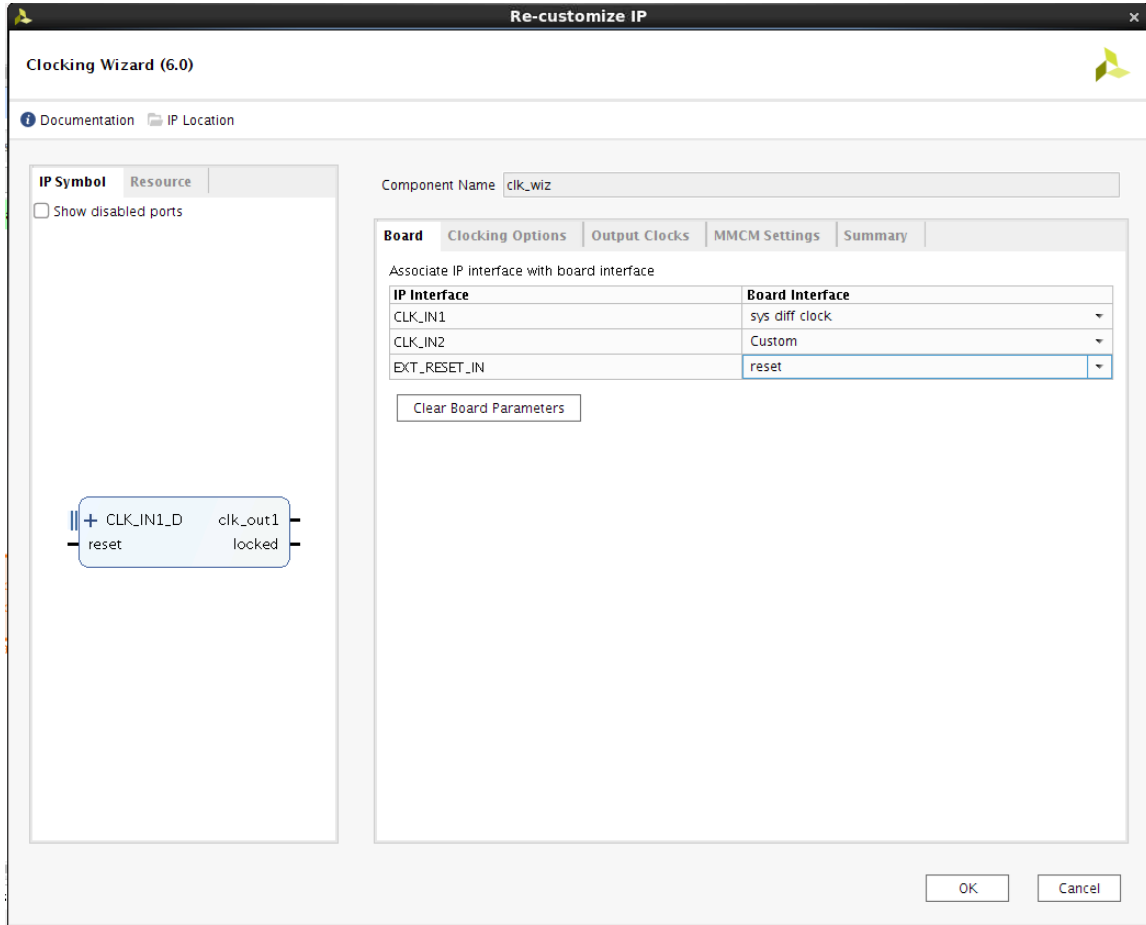

- Just as before, locate the green banner indicating that Designer Assistance is Available and click **Run Connection Automation**. When the Run Connection Automation dialog appears select the button for All Automation. Click **OK**.
- Now, `sys_diff_clk` and `reset` are connected to external ports. Examine the connectivity of the design and notice that it might be necessary to monitor AXI transactions between the JTAG to AXI master and the AXI BRAM Controller slave. This is possible if a System ILA is added to probe the AXI bus between the AXI BRAM Controller and the JTAG to AXI master.

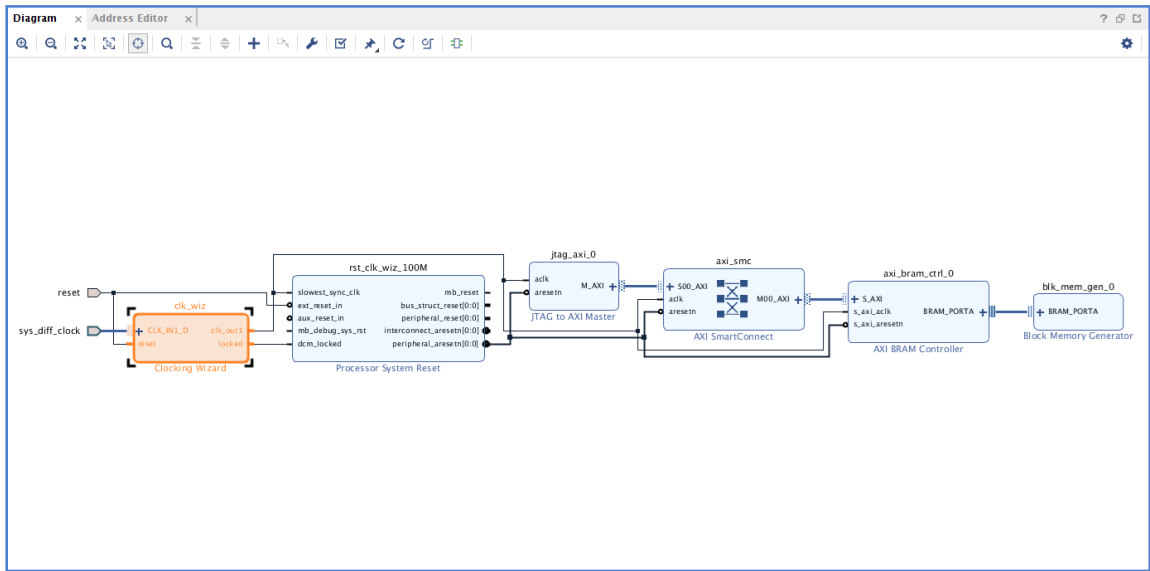

- To add a System ILA to the design, click the Add IP (+) button as in previous steps. Search for System ILA, and double click to add it to the block diagram. When it appears in the block diagram canvas, double-click on it to invoke the Customization Dialog. Ensure that both Capture Control and Advanced Trigger are selected. Also, set the Number of Comparators to the value 3. Click **OK**.

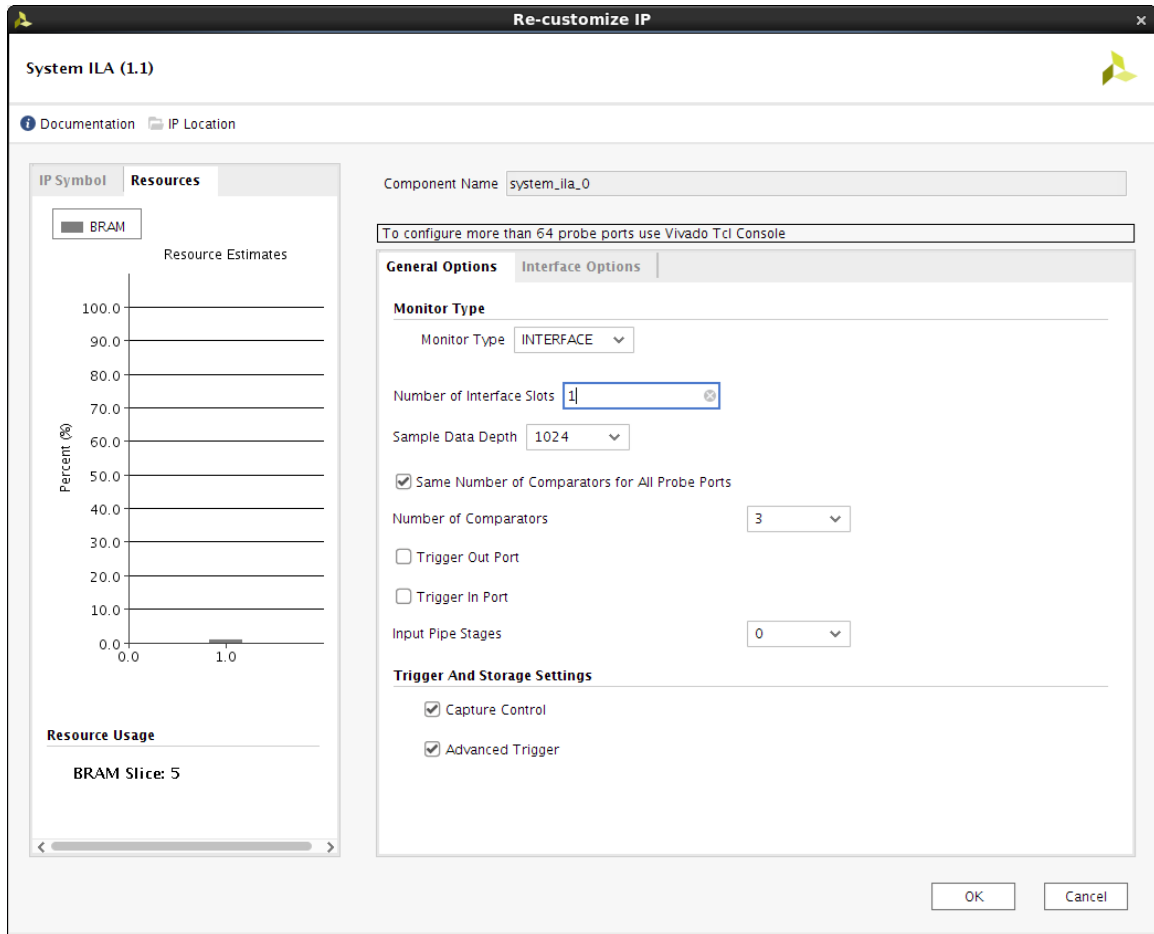

20. Now, make a connection between the System ILA `SLOT_0_AXI` port and the `S_AXI` port on the AXI BRAM Controller. Do this by clicking on the `SLOT_0_AXI` port and clicking again on the `S_AXI` port on the AXI BRAM Controller.

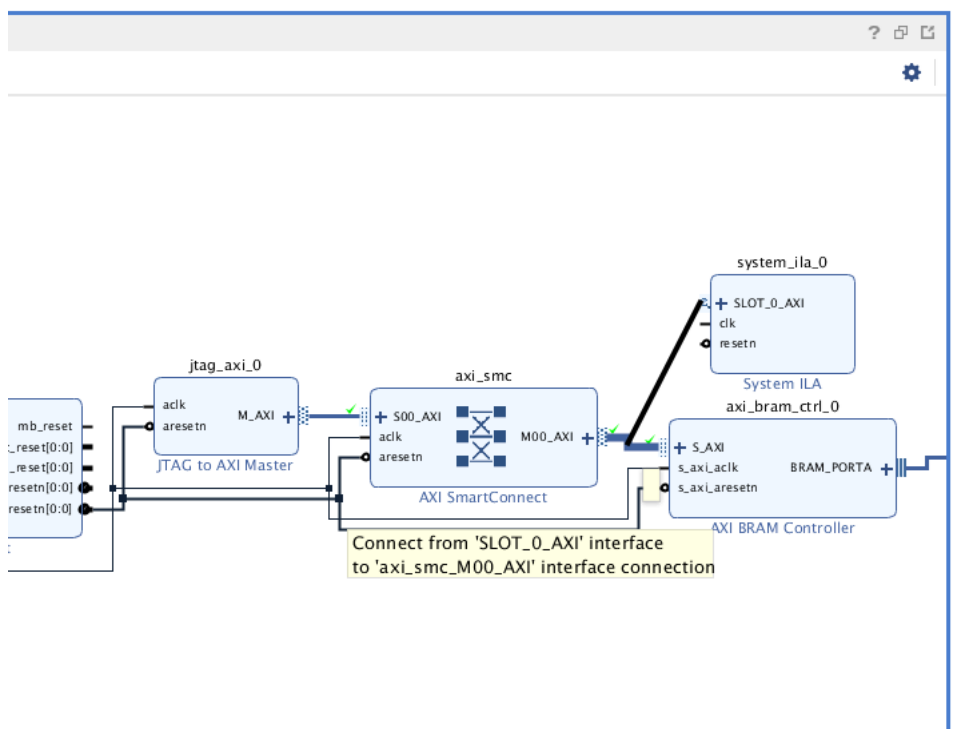

- When the Run Connection Automation banner appears, click it and select **All Automation**. Then click **OK**. Notice that the clk and resetn ports on the System ILA are connected to the AXI clock and the AXI reset.

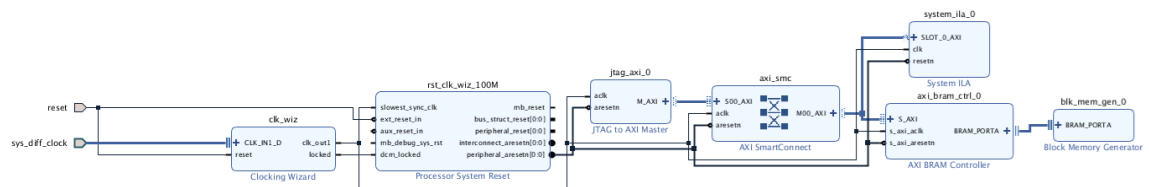

- In the upper left side of the Vivado IDE, click **File** → **Save Block Design**. Select **File** → **Close Block Design** in the same menu to close the block design.
- In the sources window, right-click on **design\_1 block design** and select **Create HDL Wrapper**. Allow Vivado IDE to manage the wrapper, and click **OK**.
- In the Flow Navigator on the left side of the Vivado IDE, click **Generate Bitstream**.
- Click **OK** to implement the design.
- Wait until the Vivado Status window shows write\_bitstream complete.
- In the Bitstream Generation Completed dialog, select **Open Hardware Manager**, and click **OK**.

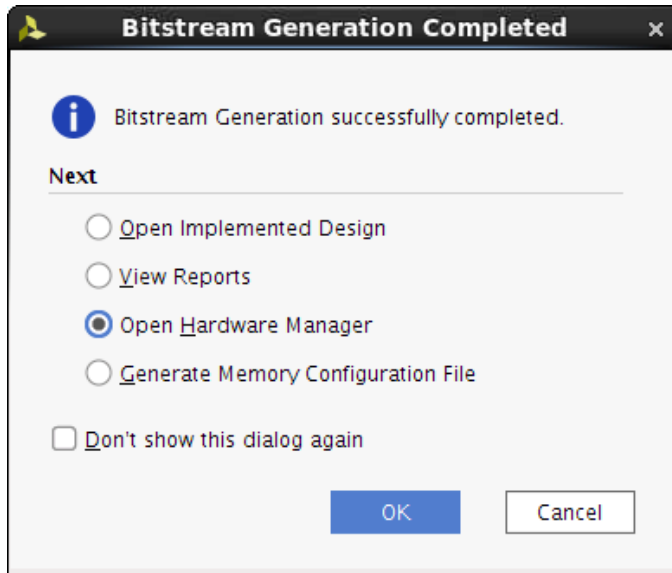

## Step 2: Program the KC705 Board and Interact with the JTAG to AXI Master Core

1. Connect your KC705 board's USB-JTAG interface to a machine that has Vivado® IDE and cable drivers installed and power up the board.
2. The Hardware Manager window opens. Click **Open New Target**. The Open New Hardware Target dialog opens.

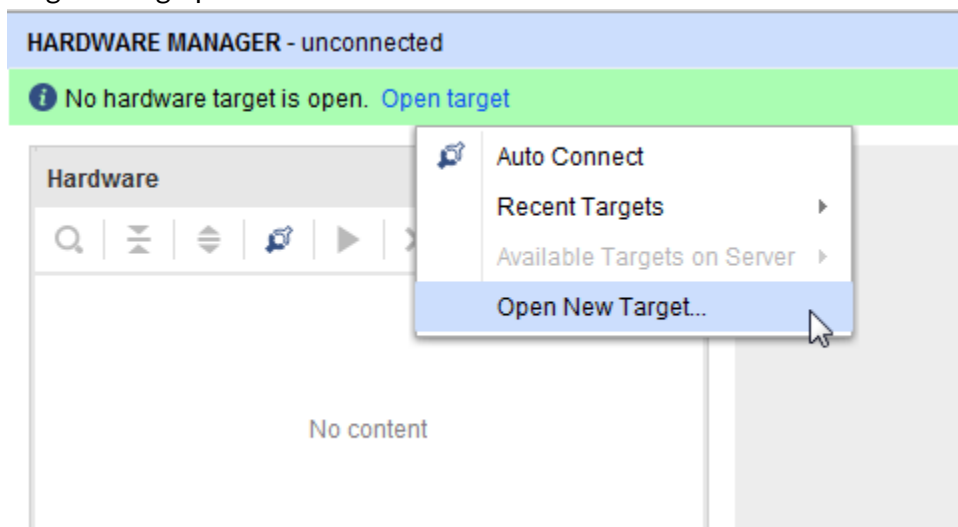

3. In the Connect to field choose **Local server**, and click **Next**.

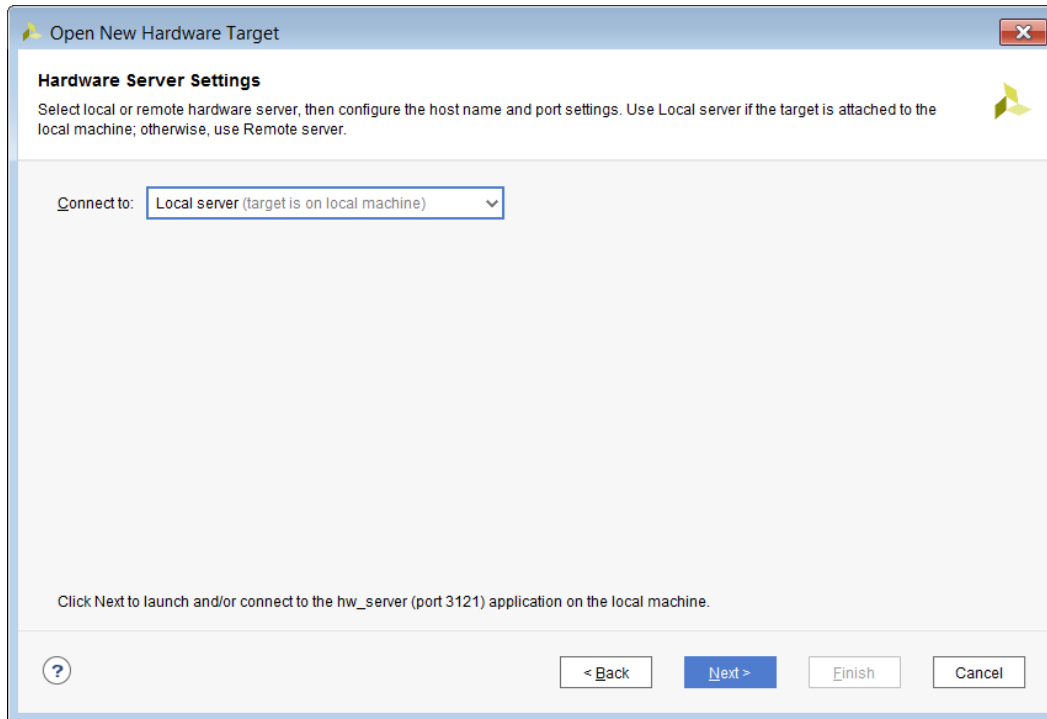

**Note:** Depending on your connection speed, this may take about 10 to 15 seconds.

4. If there is more than one target connected to the hardware server, you see multiple entries in the Select **Hardware Target** page. In this tutorial, there is only one target as shown in the following figure. Leave these settings at their default values, and click **Next**.

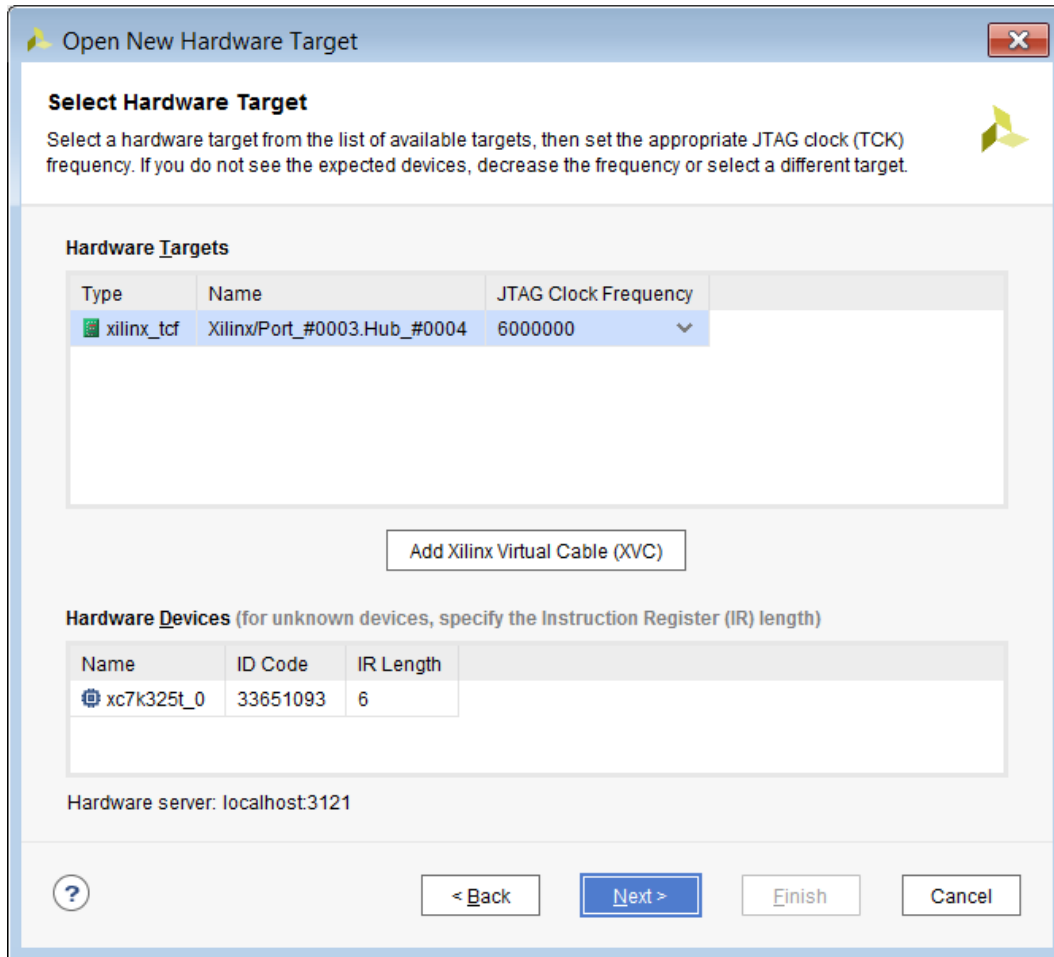

5. Leave these settings at their default values as shown. Click **Next**.
6. In the Open Hardware Target Summary page, click **Finish** as shown in the following figure.

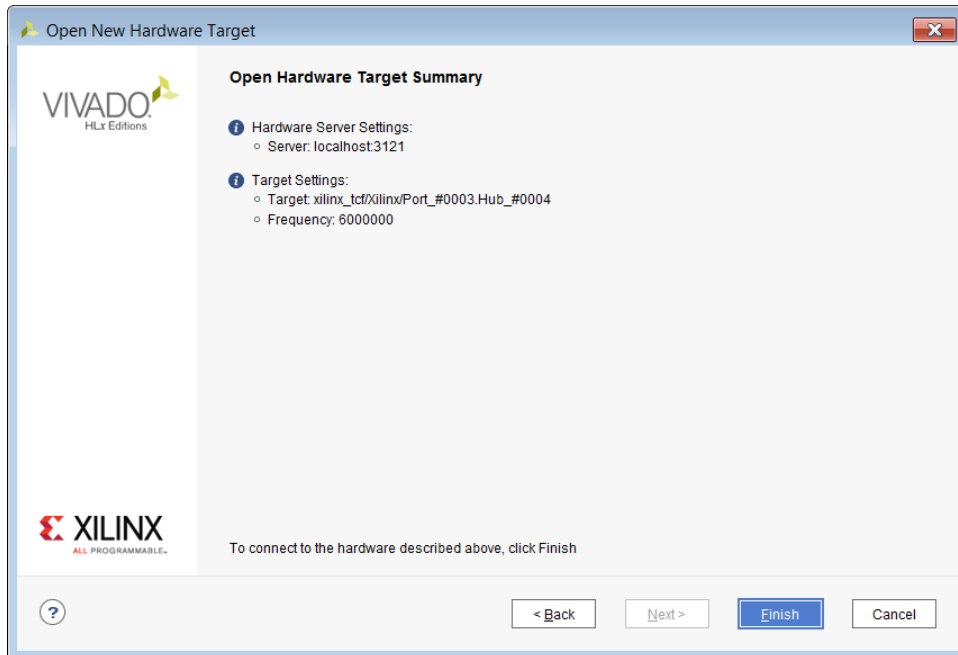

Wait for the connection to the hardware to complete. After the connection to the hardware target is made, the Hardware dialog shown in the following figure opens.

**Note:** The Hardware tab in the Debug view shows the hardware target and XC7K325T device that was detected in the JTAG chain.

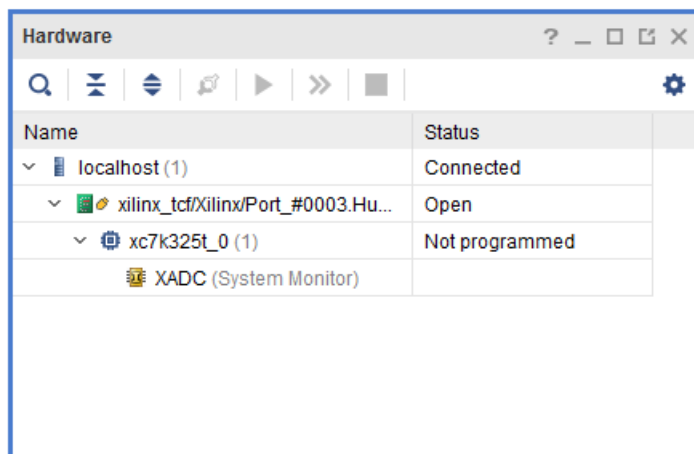

- Next, program the previously created XC7K325T device using the `.bit` bitstream file by right-clicking the XC7K325T device, and selecting **Program Device** as shown in the following figure.
- In the Program Device dialog verify that the `.bit` file is correct for the lab that you are working on. Click **Program** to program the device.



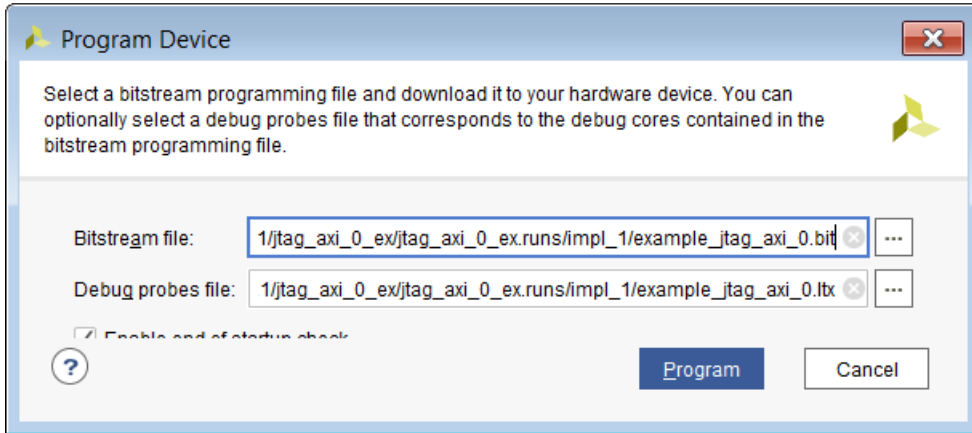

**Note:** Wait for the program device operation to complete. This can take a few minutes.

- Verify that the JTAG to AXI Master and ILA cores are detected by locating the hw\_axi\_1 and hw\_ila\_1 instances in the Hardware Manager window.

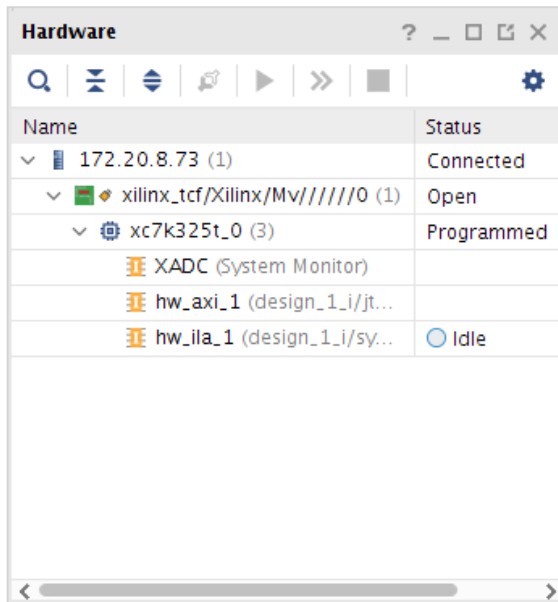

- You can communicate with the JTAG to AXI Master core via Tcl commands only. You can issue AXI read and write transactions using the run\_hw\_axi command. However, before issuing these transactions, it is important to reset the JTAG to AXI Master core. Because the aresetn input port of the jtag\_axi\_0 core instance is not connected to anything, you need to use the following Tcl commands to reset the core:

```
reset_hw_axi [get_hw_axis hw_axi_1]
```

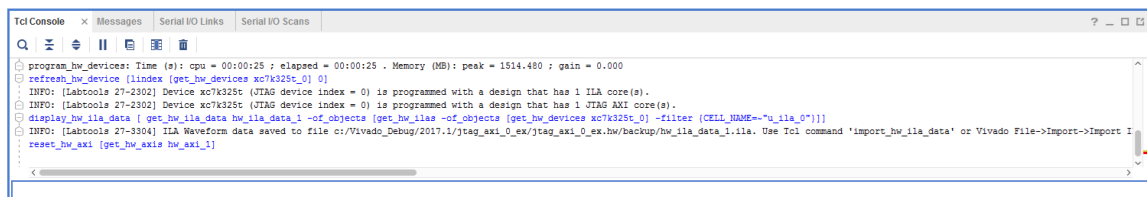

11. The next step is to create a 4-word AXI burst transaction to write to the first four locations of the BRAM:

```
set wt [create_hw_axi_txn write_txn [get_hw_axis hw_axi_1] -type WRITE -
address C0000000 -len 128 -data {44444444_33333333_22222222_11111111}]
```

where:

- `write_txn` is the name of the transaction.
- `[get_hw_axis hw_axi_1]` returns the `hw_axi_1` object.
- `-address C0000000` is the start address.
- `-len 128` sets the AXI burst length to 128 words
- `-data {44444444_33333333_22222222_11111111}` is the data to be written.

**Note:** The data direction is MSB to the left (i.e., address 3) and LSB to the right (i.e., address 0). Also note that the data will be repeated from the LSB to the MSB to fill up the entire burst.

12. The next step is to set up a 128-word AXI burst transaction to read the contents of the first four locations of the AXI-BRAM core:

```
set rt [create_hw_axi_txn read_txn [get_hw_axis hw_axi_1] -type READ -
address C0000000 -len 128]
```

where:

- `read_txn` is the name of the transaction.
- `[get_hw_axis hw_axi_1]` returns the `hw_axi_1` object.
- `-address C0000000` is the start address.
- `-len 128` sets the AXI burst length to 4 words.

13. After creating the transaction, you can run it as a write transaction using the `run_hw_axi` command:

```
run_hw_axi $wt
```

This command should return the following:

```
INFO: [Labtools 27-147] : WRITE DATA is :
44444444333333332222222211111111...
```

14. After creating the transaction, you can run it as a read transaction using the `run_hw_axi` command:

```
run_hw_axi $rt
```

This command should return the following:

```
INFO: [Labtools 27-147] : READ DATA is :
44444444333333332222222211111111...
```

## Step 3: Using ILA Advanced Trigger Feature to Trigger on an AXI Read Transaction

1. In the ILA - hw\_ila\_1 dashboard, locate the Trigger Mode Settings area and set Trigger mode to **ADVANCED\_ONLY**.
2. In the Capture Mode Settings area, set the Trigger position to **512**.
3. In the Trigger State Machine area click the **Create new trigger state machine** link.

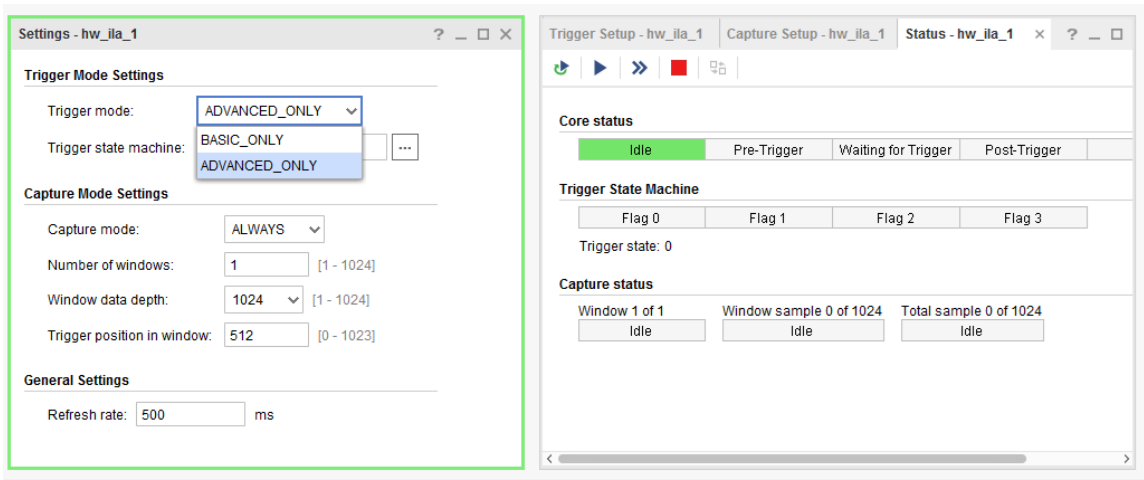

4. In the New Trigger State Machine File dialog box, set the name of the state machine script to **txns.tsm**.

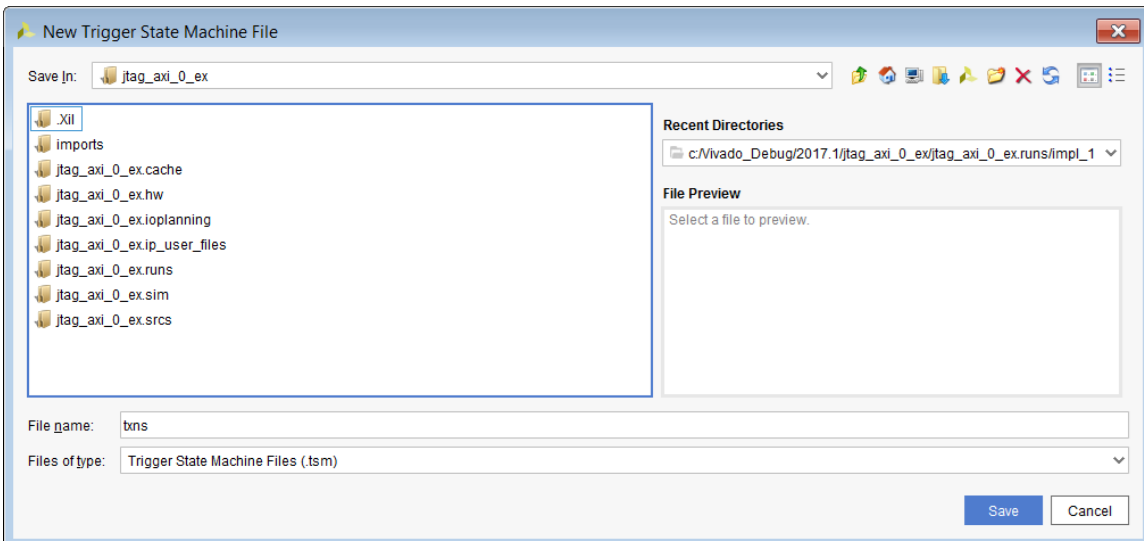

5. A basic template of the trigger state machine script is displayed in the Trigger State Machine gadget. Expand the trigger state machine gadget in the ILA dashboard. Copy the script below after line 17 of the state machine script and save the file.

```
# The "wait_for_arvalid" state is used to detect the start
# of the read address phase of the AXI transaction which
# is indicated by the axi_arvalid signal equal to '1'
#
state wait_for_arvalid:
    if (design_1_i/system_ila_0/U0/net_slot_0_axi_arvalid == 1'b1) then
        goto wait_for_rready;
    else
        goto wait_for_arvalid;
    endif
#
# The "wait_for_rready" state is used to detect the start
# of the read data phase of the AXI transaction which
# is indicated by the axi_rready signal equal to '1'
#
state wait_for_rready:
    if (design_1_i/system_ila_0/U0/net_slot_0_axi_rready == 1'b1) then
        goto wait_for_rlast;
    else
        goto wait_for_rready;
    endif
#
# The "wait_for_rlast" state is used to detect the end
# of the read data phase of the AXI transaction which
# is indicated by the axi_rlast signal equal to '1'.
# Once the end of the data phase is detected, the ILA core
# will trigger.
#
state wait_for_rlast:
    if (design_1_i/system_ila_0/U0/net_slot_0_axi_rlast == 1'b1) then
        trigger;
    else
        goto wait_for_rlast;
    endif
```

**Note:** Use the state machine to detect the various phases of an AXI read transaction:

- Beginning of the read address phase
  - Beginning of the read data phase
  - End of the read data phase
6. Arm the trigger of the ILA by right-clicking the **hw\_ila\_1 core** in the Hardware Manager window and selecting **Run Trigger**.

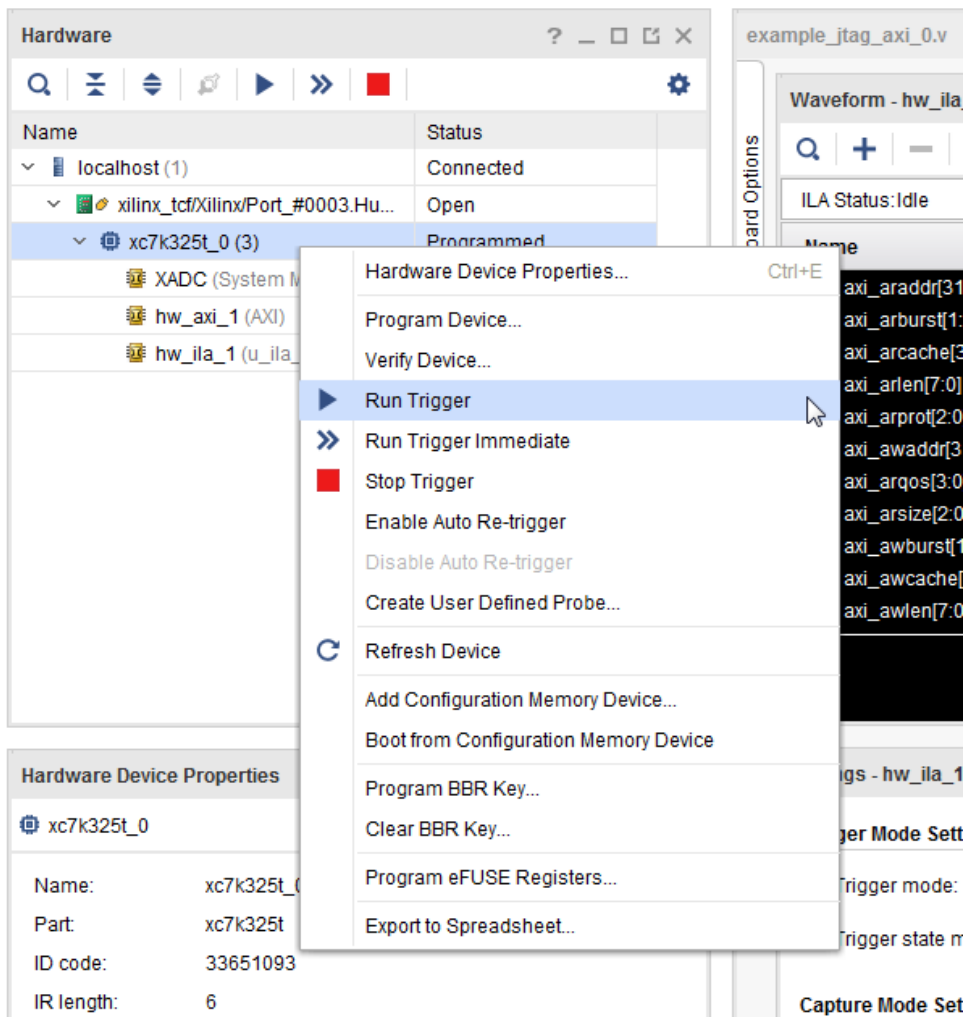

7. In the Trigger Capture Status window, note that the ILA core is waiting for the trigger to occur, and that the trigger state machine is in the wait\_for\_a\_valid state. Note that the pre-trigger capture of 512 samples has completed successfully:

Settings - hw\_ila\_1    Status - hw\_ila\_1 x

Core status    ● ○ ○ ○ ○    Waiting for Trigger

Trigger State Machine - Flags: ○ ① ○ ② ○ ③

Trigger state:    wait\_for\_arvalid (0)

Capture status - Window 1 of 1

Window sample 512 of 1024

50%

- In the Tcl Console, run the read transaction that you set up in the previous section of this tutorial.

```
run_hw_axi $rt
```

**Note:** The ILA core has triggered and the trigger mark is on the sample where the `axi_rlast` signal is equal to '1', just as the trigger state machine program intended.

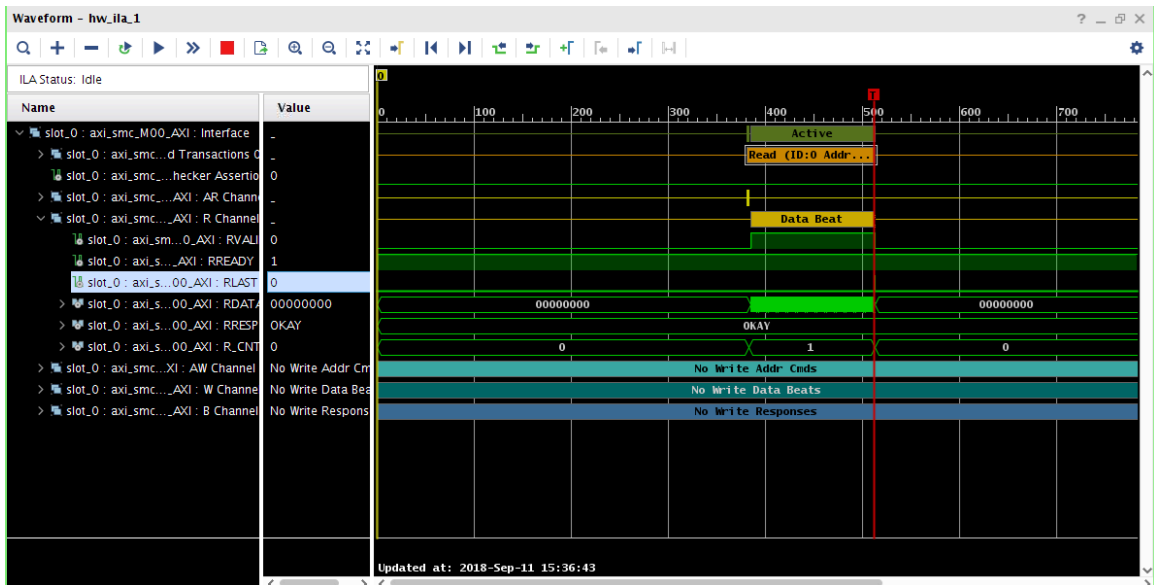

# Using the Vivado Serial Analyzer to Debug PS-GTR Serial Links

IBERT UltraScale+™ PS-GTR (IBERT PS-GTR) transceiver can be used to evaluate and monitor PS-GTR transceivers in Zynq® UltraScale+™ MPSoC devices. With this feature, you can accomplish these tasks:

- Perform eye scans with user data
- Change PS-GTR settings
- View link status
- Check the “lock” status of all phase-locked loops (PLLs) used by all PS-GTR lanes

IBERT PS-GTR transceiver does *not* provide these capabilities:

- Perform eye scans with raw pseudo-random binary sequence (PRBS) data patterns
- Measure Bit Error Ratio (no bit or error counters)

Note that this solution is purely software based, meaning that no IP or logic is required in the programmable logic (PL) of the device. This documentation guides you through the setup of the PS-GTR Transceivers by creating a first stage boot loader (FSBL). It then demonstrates how to load the FSBL into the Zynq UltraScale+ MPSoC and use IBERT PS-GTR.



---

**TIP:** This is a supported feature in Vivado® Design Suite 2017.2 and above.

---

---

## IBERT PS-GTR Flow

The IBERT PS-GTR Bring-up and subsequent EyeScan involves three different components:

1. Generating Zynq UltraScale+ MPSoC PS Xilinx® Support Archive (XSA) file from the Vivado® tool after configuring the PS-GTR.
2. Using the Vitis™ Xilinx Software Command-line Tool (XSCT) flow to generate a FSBL file using the XSA file.
3. Using the FSBL file with Vivado Serial I/O Analyzer to bring up IBERT PS-GTR.

## Tools Required

- Vivado
- Vitis
- XSCT (Part of the Vitis tool)

## Board/Part/Components Required

- ZCU102 Rev 1.0 board
- XCZU9EG-FFVB1156 production device
- PCIe®
  - A PCIe card which has at least x4 lanes
  - PCI Express 4x Male to PCIe 16x Female Riser Cable if PCIe card is larger than x4
- SATA
  - SanDisk 128 GB SATA SSD Drive
  - SATA connector cable
  - 4 Pin Molex to SATA Power Cable Adapter
- USB
  - SanDisk Ultra 32 GB USB 3.0 Flash Drive
  - USB 3.0 Type A Female to Micro Male Adapter

## Required Files

- FSBL executable and linkable format file (ELF File) (Created using the following instructions) which configures the PS-GTR
- Configuration Bitstream File (Optional file that may be needed to custom configure the FPGA depending on the board setup)
- Tcl script to generate the FSBL and modify C-source for USB Support (when available)

## Assumptions

1. FSBL should always target Cortex®-A53 processor as R5 (psu\_cortexr5\_0) is exclusively used by IBERT PS-GTR.
2. Physical devices such as SATA drive, PCIe card, etc. are needed for validation.



# Step 1: Generating a Zynq UltraScale+ MPSoC PS Xilinx Support Archive

1. Open the Vivado IDE.
2. Click **Create Project**, and click **Next**.

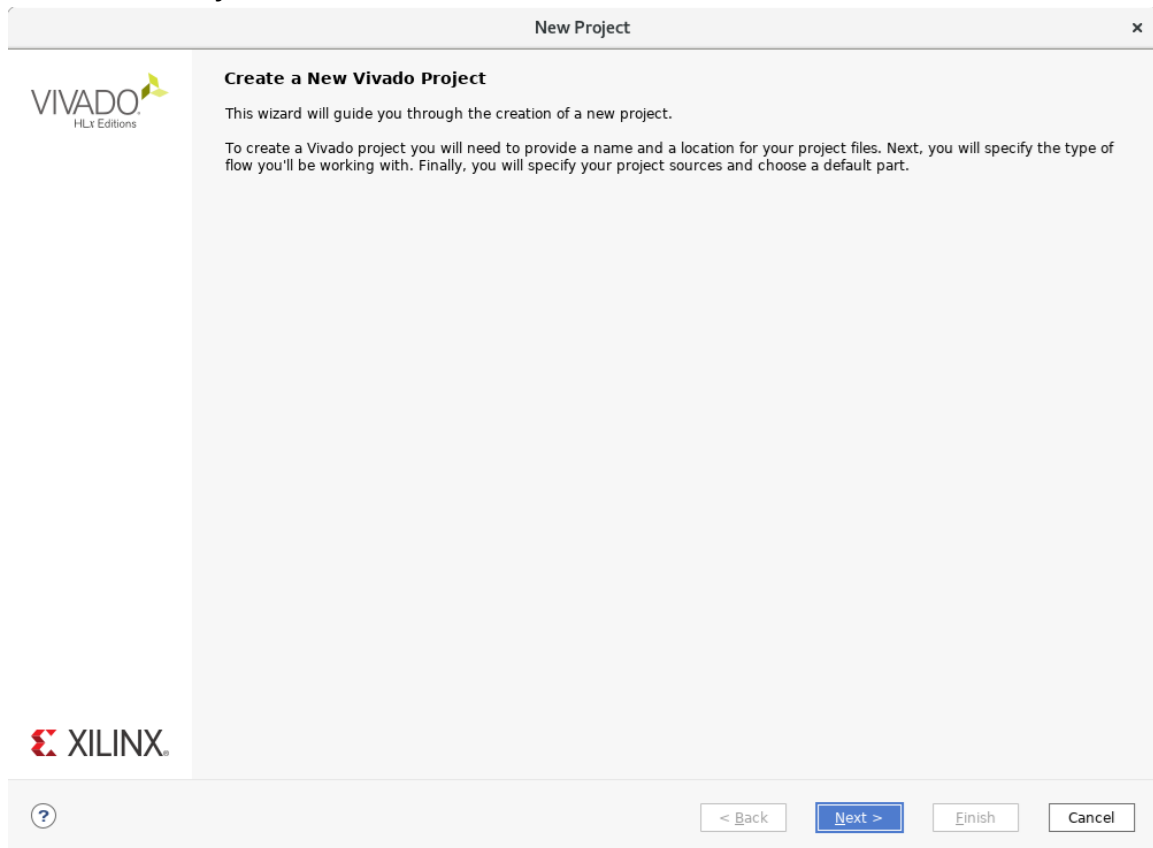

3. Set your project name, and specify the project directory. Click **Next**.
4. Select Project type as **RTL project**.
5. Select do not specify sources at this time checked, then click **Next**.
6. To choose the board, click the board icon, and select **Zynq UltraScale+ ZCU102 Evaluation board**, with Board Rev 1.0. Click **Next**.

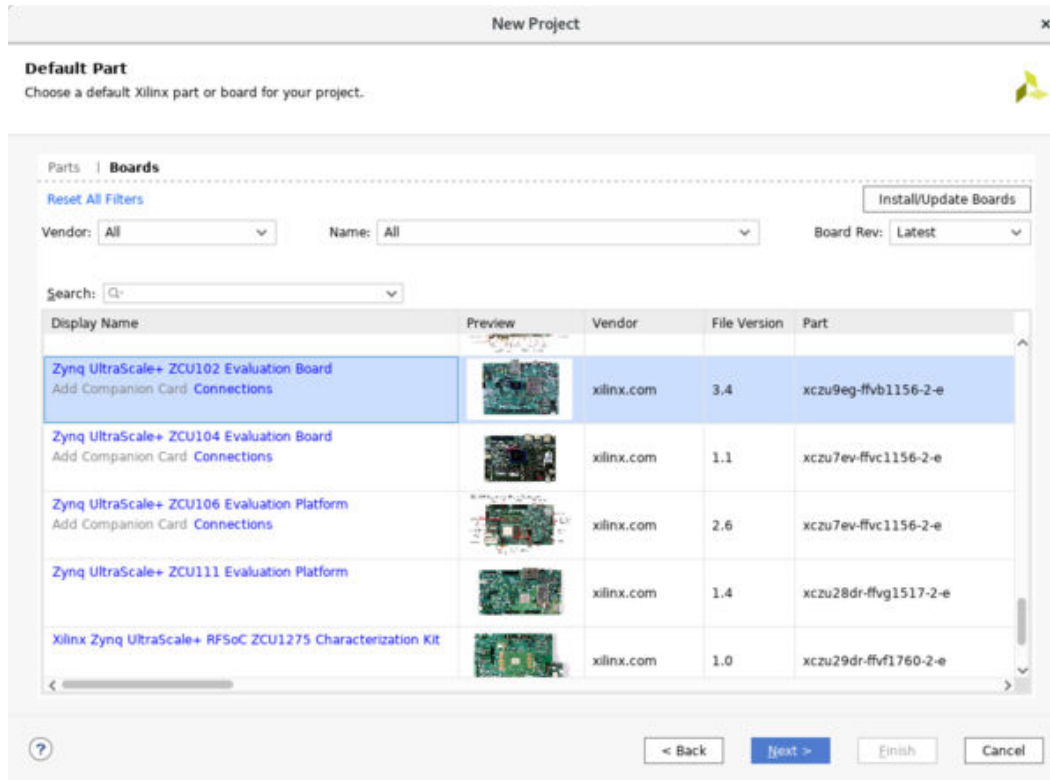

7. The project summary displays. To create the project, click **Finish**.
8. In the Flow Navigator, select **Create Block Design**. You can specify the design name and directory, but it is not necessary for a local project directory. Click **OK** to create the block design.

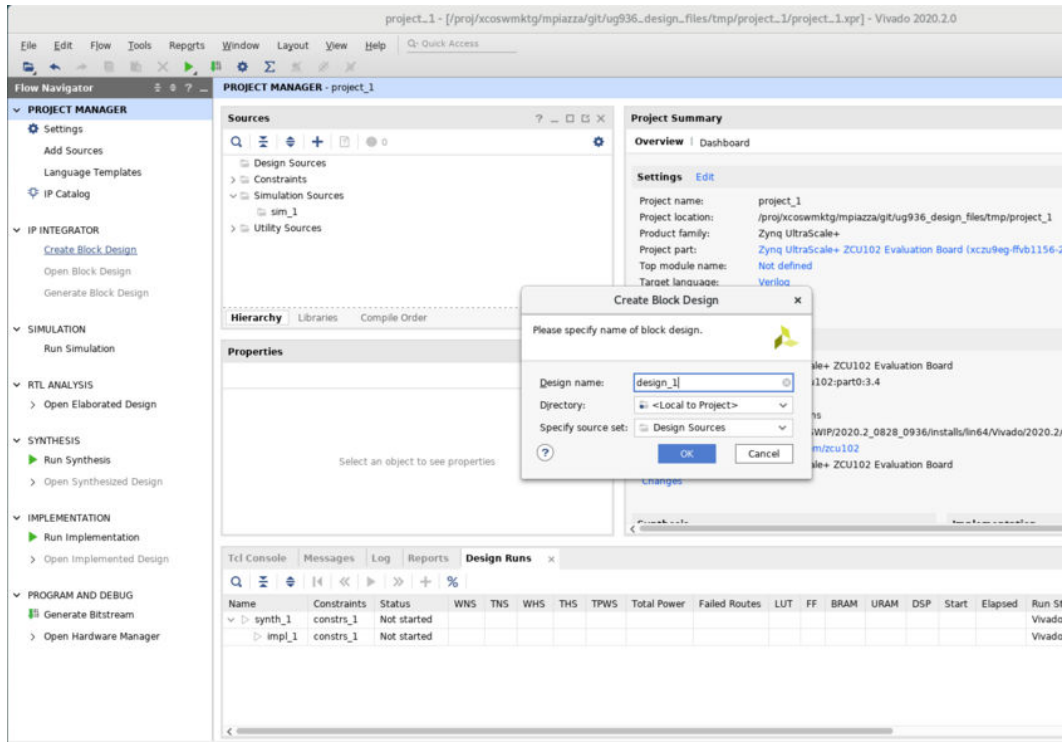

- An empty design diagram displays. Click the **Add IP** button to add IP. Select the IP based on the selected board (for the ZCU102 evaluation board, search for Zynq UltraScale+ MPSoC) and double-click the selected IP.

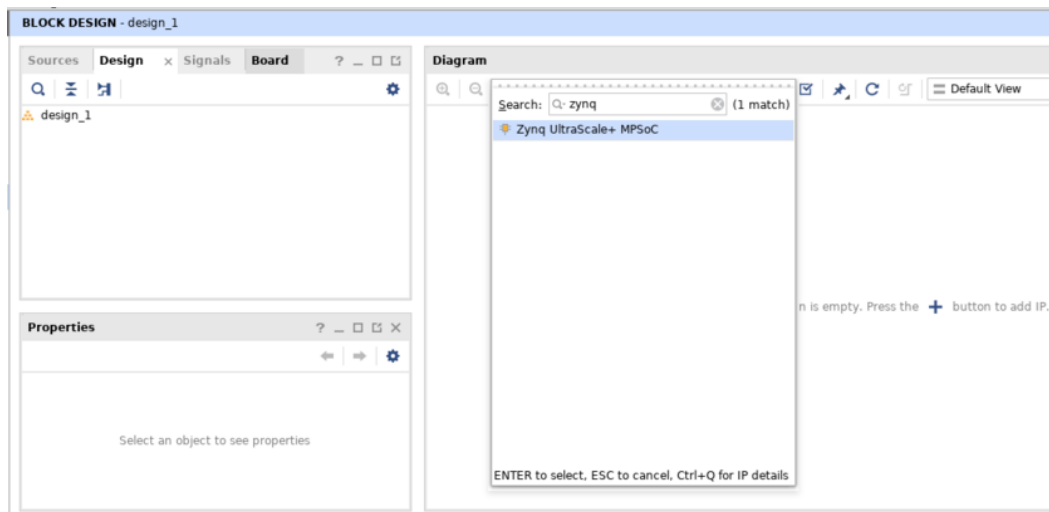

- In the design diagram window, select **Run Block Automation**. Click **OK** to continue creating the ZCU102 design.

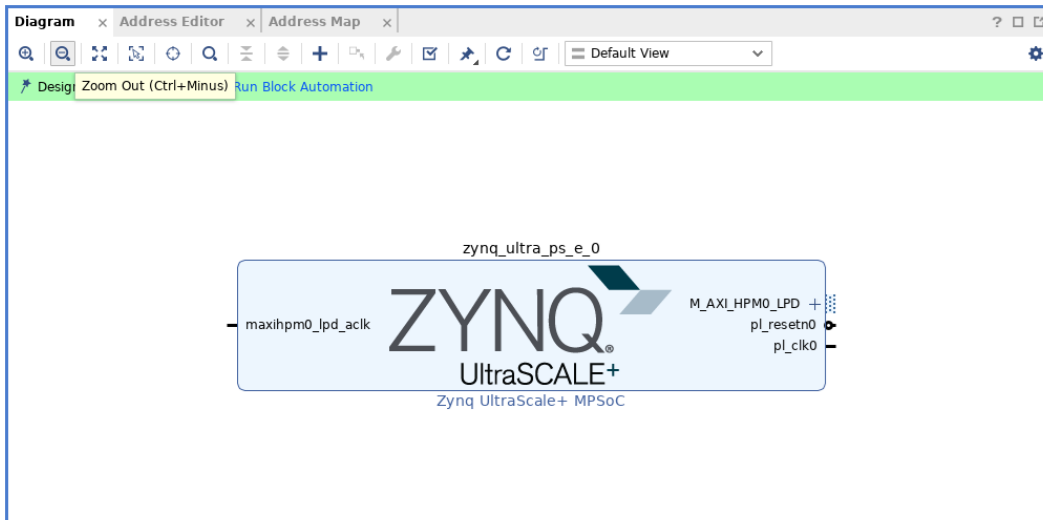

11. When the design diagram appears, use the following steps to validate the design:
  - a. Connect `maxihpm0_fpd_aclk` and `maxihpm1_fpd_aclk` together to `pl_clk0`, as shown in the following figure.
    - i. Select `maxihpm0_fpd_aclk` and drag it to `maxihpm1_fpd_aclk`.
    - ii. Select `maxihpm1_fpd_aclk` and drag it to `pl_clk0`.
  - b. Right-click the Zynq UltraScale+ MPSoC block and select **Validate Design** to validate the design. It will say validation successful. Click **OK**.

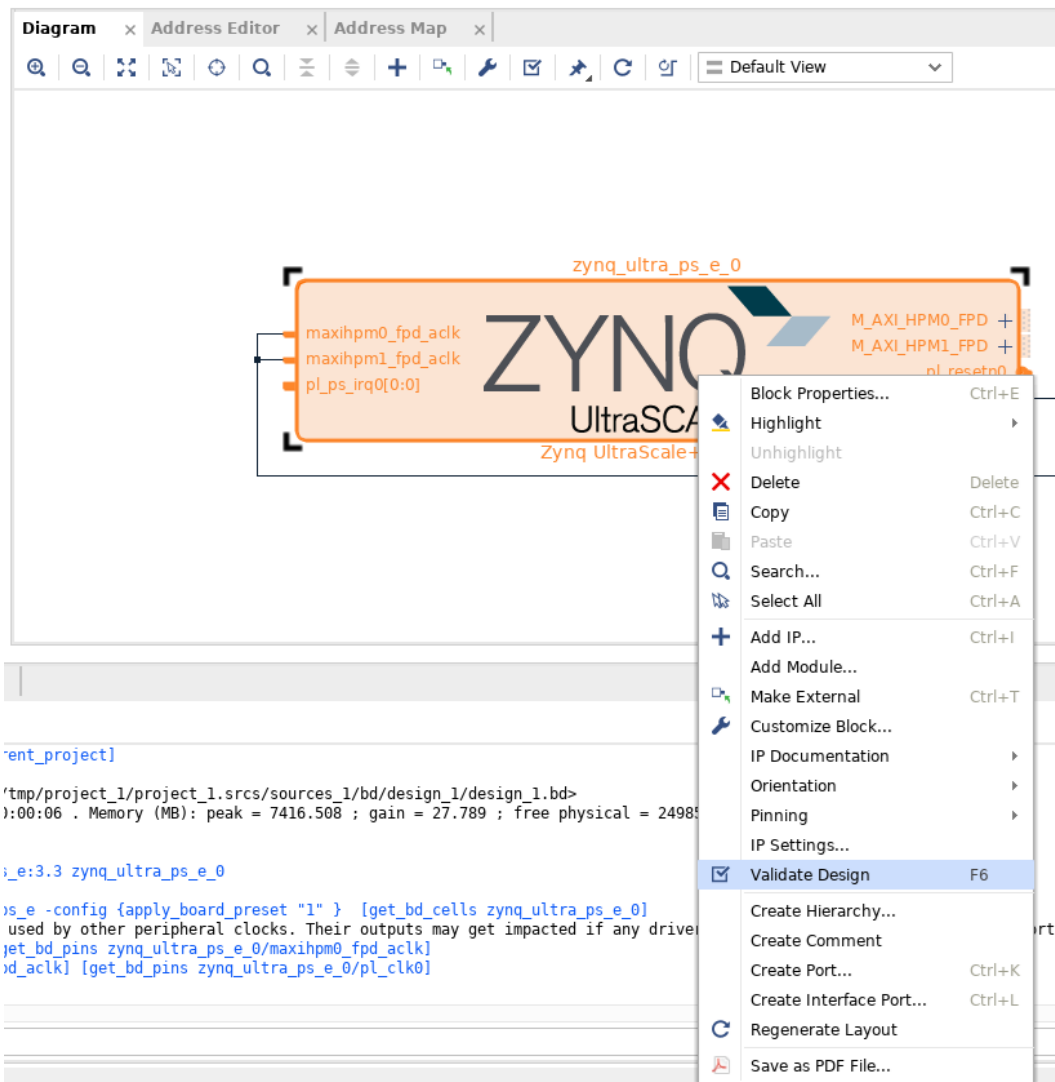

12. Customize the design by double-clicking the Zynq UltraScale+ MPSoC block and configuring the parameters. There are four valid GT configurations for ZCU102 board as shown in the following table.

**Table 2: Supported PS-GTR Connector Functionality**

SEL (S3,2,1,0)	ICM Settings (Lane 0,1,2,3)	PCIe Connector	DP Connector	USB Connector	SATA Connector
0 0 0 0	PCIe.0, PCIe.1, PCIe.2, PCIe.3	PCIe Gen2 x4	N.C.	N.C.	N.C.
1 1 1 1	DP.1, DP.0, USB, SATA	N.C.	DP.0, DP.1	USB0	SATA1
1 1 0 0	PCIe.0, PCIe.1, USB, SATA	PCIe Gen2 x2	N.C.	USB0	SATA1
1 1 1 0	PCIe.0, DP.0, USB, SATA	PCIe Gen2 x1	DP.0	USB0	SATA1

13. Select the settings based on your requirements by double-clicking the Zynq UltraScale+ MPSoC block to customize GT Lane configuration.

14. Select **I/O Configuration** → **High Speed**. Select one of the four combinations using the settings in the following screenshots.

a. PCIe – Display Port - USB - SATA (Default Vivado preset)

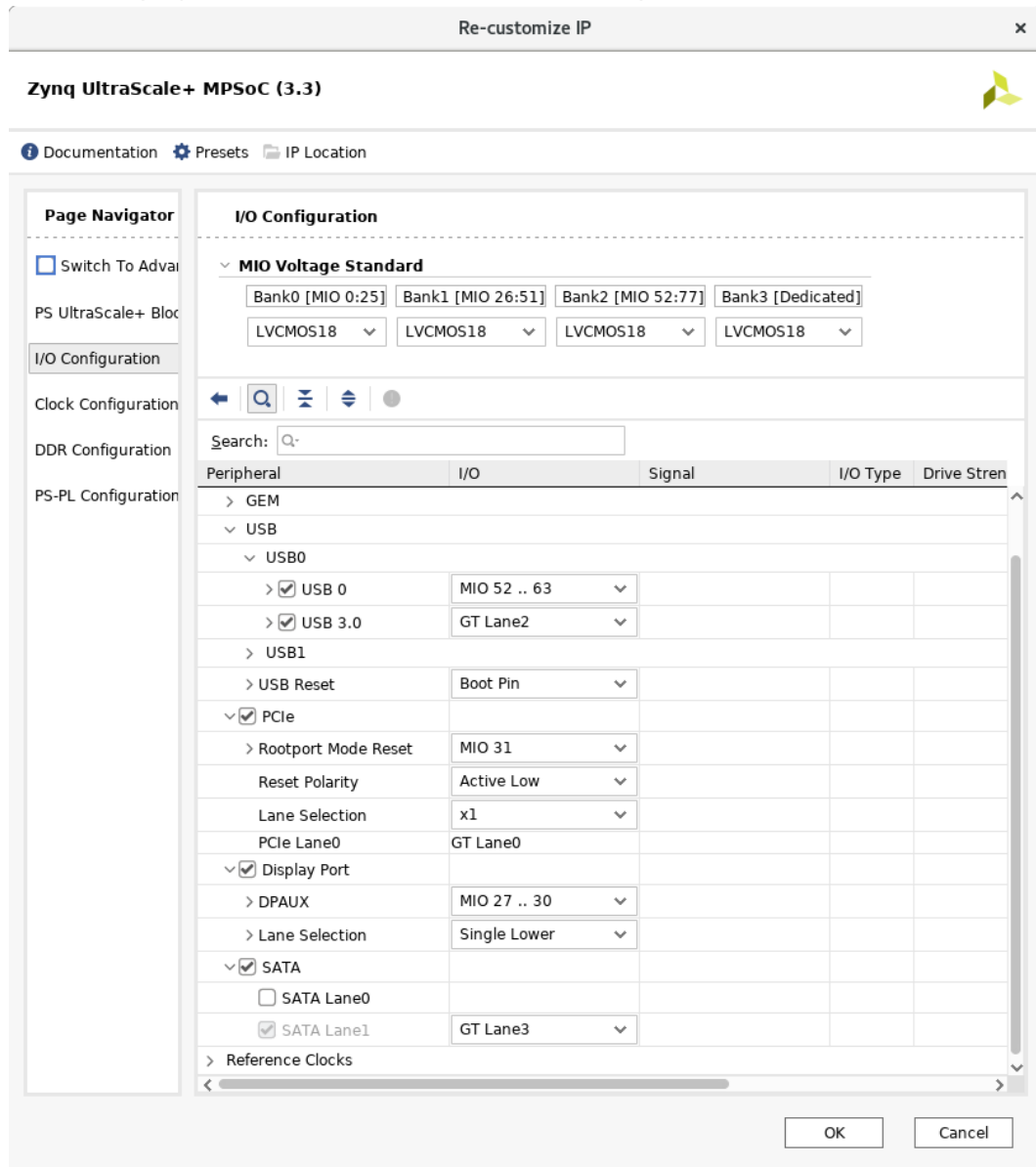

b. PCIe-PCIe - USB - SATA

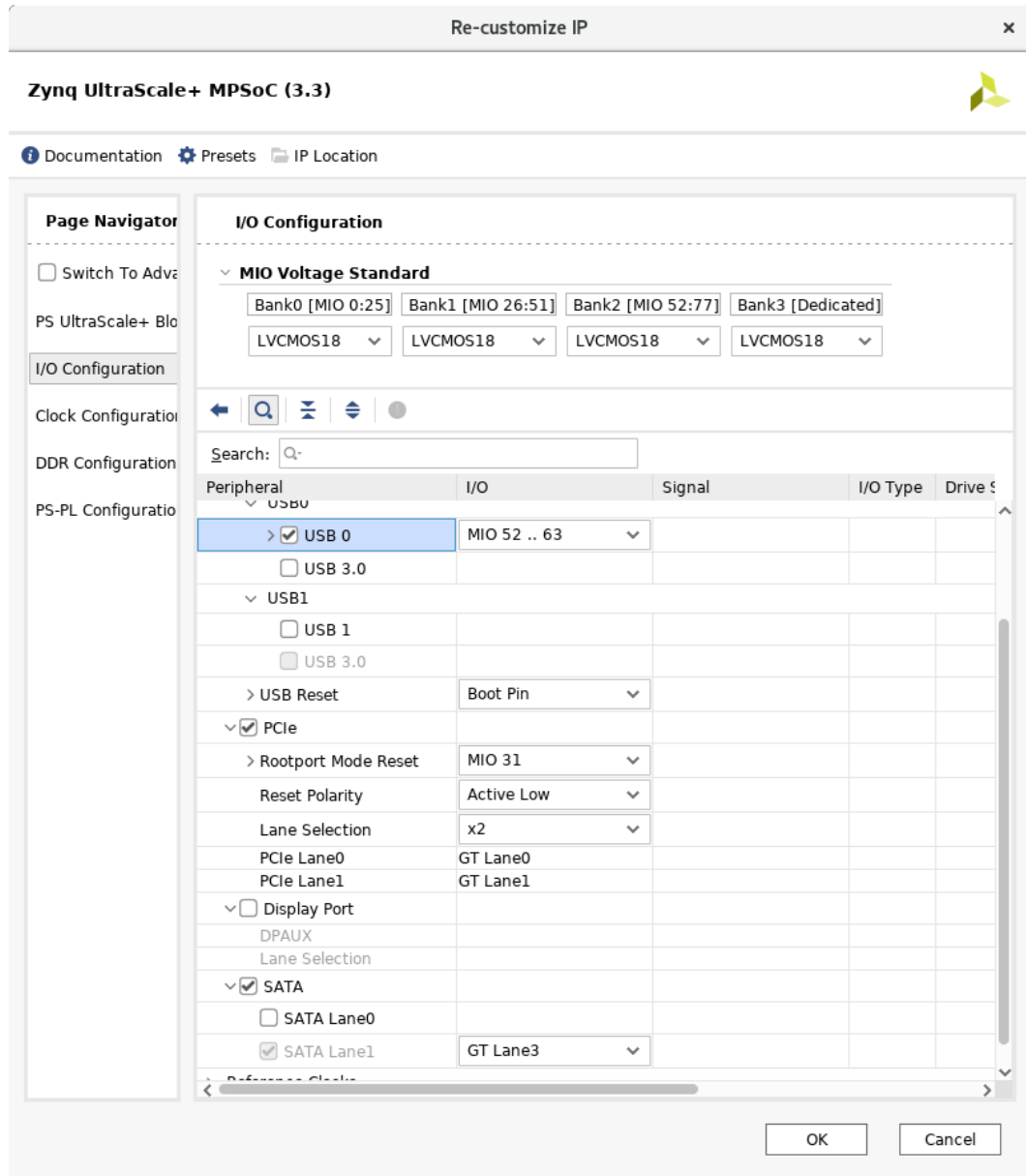

c. Display Port – Display Port - USB - SATA

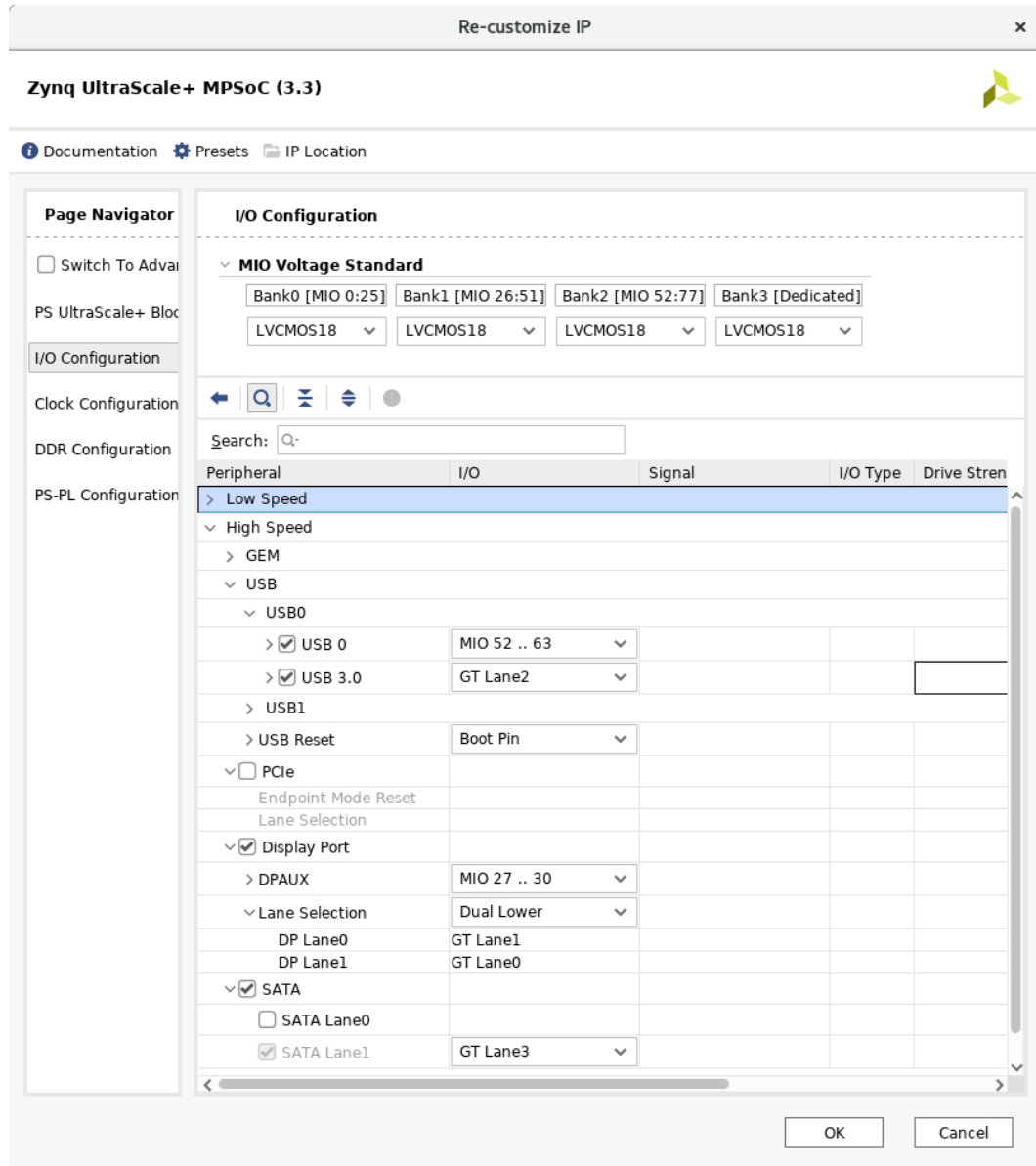

d. PCIe-PCIe - PCIe - PCIe (PCIe x4)



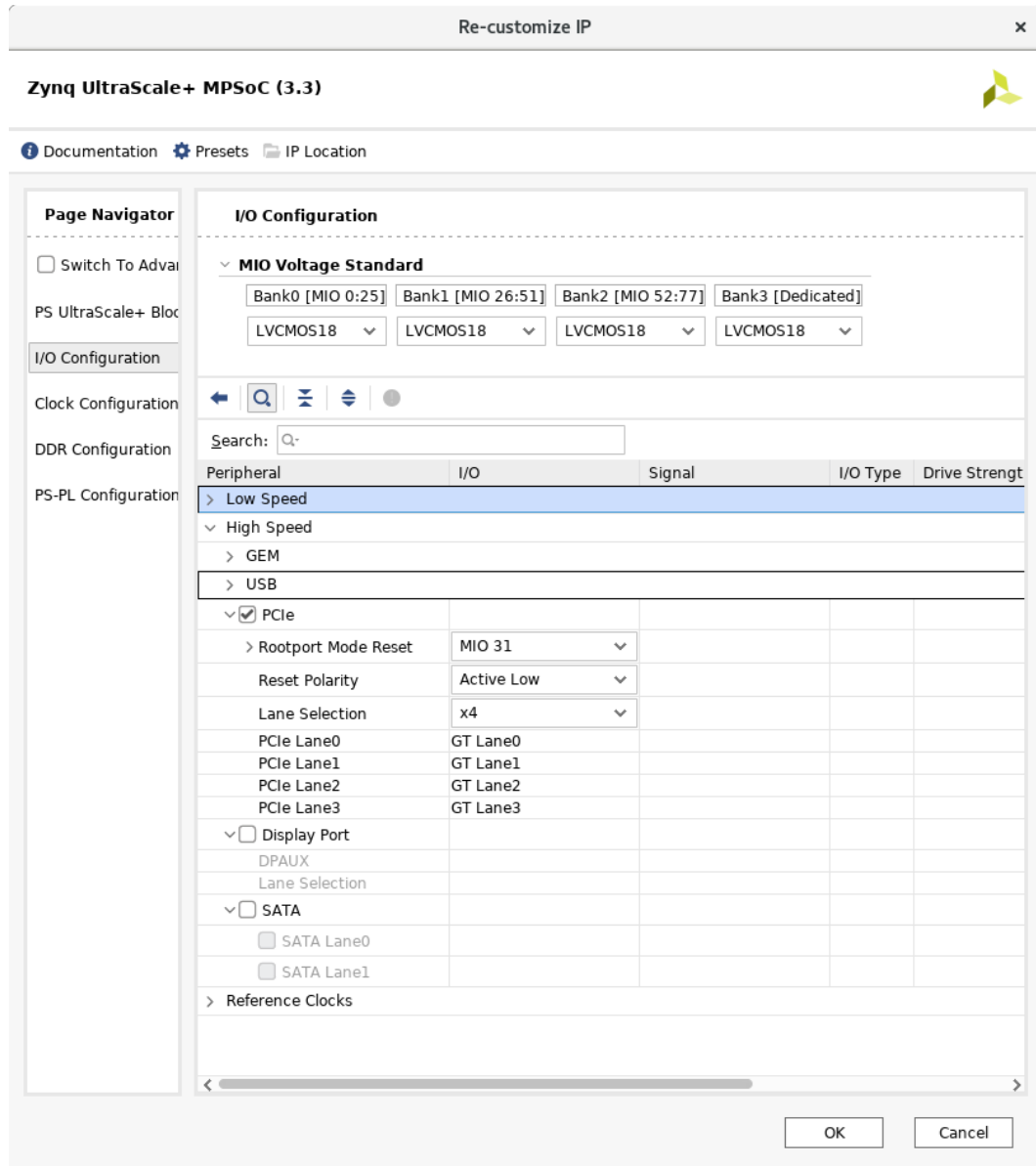

15. Click **OK** when finished customizing the GT Lane configuration.
16. Do not click Run Block Automation again, even though the banner will reappear. If used, the customized values will reset.
17. Click the **Sources** tab on the top left of the Block Design window.
  - a. Under the Block Designs group, click **IP Sources**.
  - b. Right-click **design\_1** and then click **Create HDL Wrapper**.

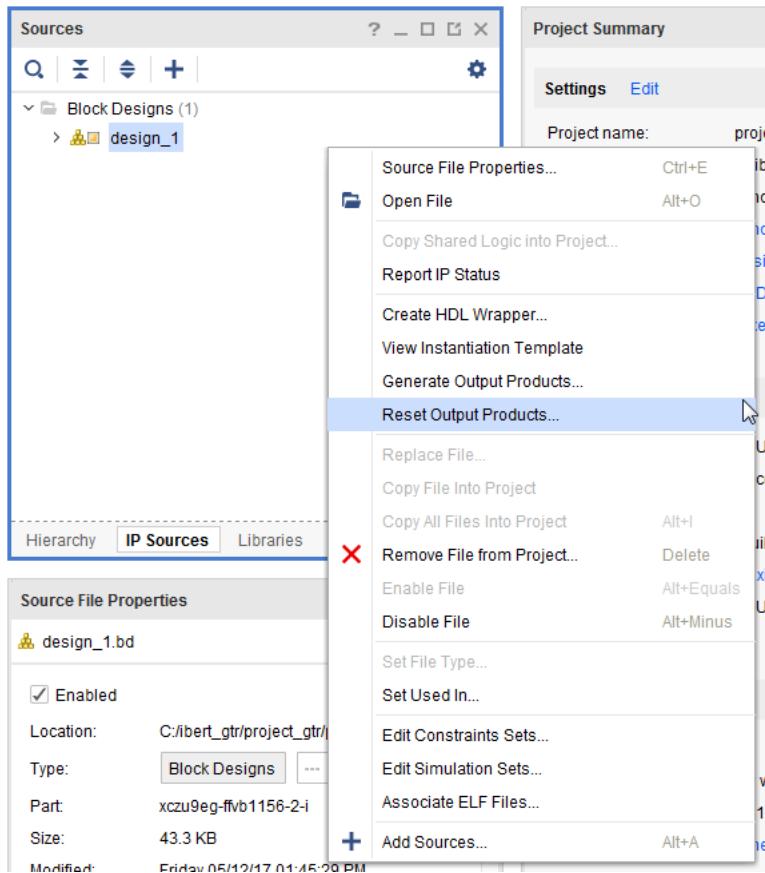

18. Leave the option Let Vivado manage wrapper and auto-update selected. Click **OK** in the dialog to create the HDL wrapper.
19. Right-click **design\_1\_i** in the IP Sources tab, and click **Generate Output Products**.
20. Click **Generate** to generate with the default options in the panel.
21. After the generation is complete, click **OK**.
22. Select **File** → **Export** → **Export Hardware**.

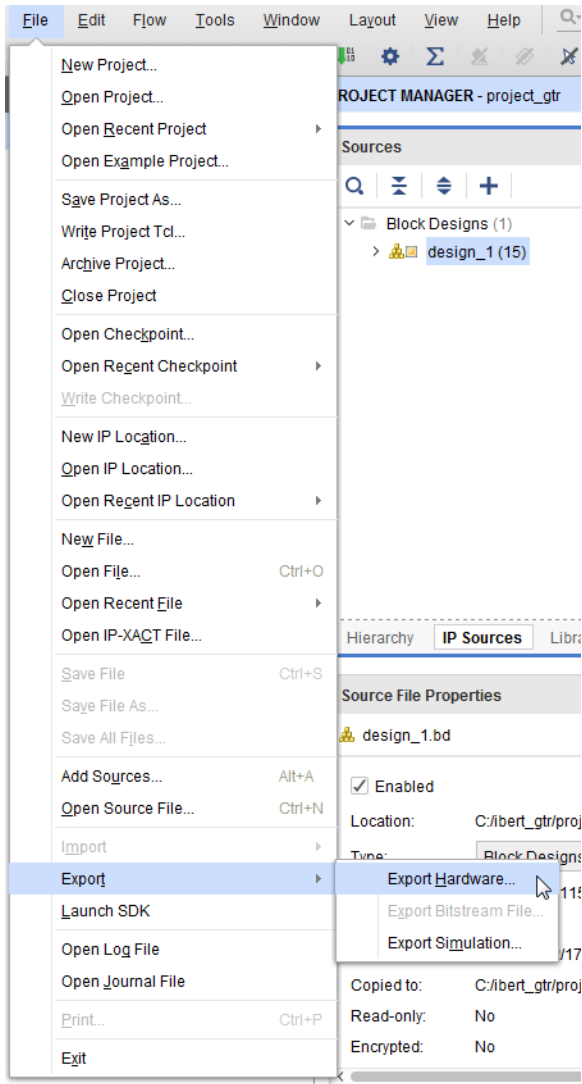

23. In the Export Hardware Platform wizard, select a Fixed platform type. Click **Next**.
24. On the next page, select **Pre-Synthesis** for the platform output type.
25. Leave the XSA name as **design\_1\_wrapper**, and choose a location to store the exported XSA, preferably in a new directory.

---

## Step 2: Using Xilinx Software Command-line Tool Flow to Generate a First Stage Boot Loader

XSCT is an interactive and scriptable command-line interface to the Vitis tool. The XSCT flow requires running a Tcl script.

## Generating Using the Xilinx Software Command-line Tool Automated Flow

To create a FSBL for the Cortex-A53 #0 (64-bit) automatically (and modify the `xfsbl_main.c/h` files if a USB is present) using the provided script, use the following steps:

1. Copy the `src/lab10/xsct_create_fsbl.tcl` script to the directory where the XSA file is located. You can modify the Tcl script if you changed the default name of the XSA file in the Vivado tool. You can also change the script if the compiler options need to be different.
2. Open a terminal on Linux or command prompt on Windows.
3. Change directory into the directory where the XSA file is located.
4. Call `xsct` from the Vitis tool install area.

```
% xsct xsct_create_fsbl.tcl
```

5. The location of the generated ELF File prints out when the script completes.

---

## Step 3: ZCU102 Board Settings

### USB Jumper Setting Requirements for HOST Mode on ZCU102

1. Make sure the following jumpers are correctly set for USB to be in HOST mode (refer to *ZCU102 Evaluation Board User Guide* ([UG1182](#))).
  - a. J7 – ON
  - b. J113 – 1-2
  - c. J110 – 2-3
2. Refer to the following image for jumper settings on a ZCU102 Rev 1.0 board.



---

## Using FSBL with Serial I/O Analyzer to Bring Up IBERT PS-GTR

1. Connect all the physical devices such as SATA Drive, PCIe® card, and USB device based on your selection from the four valid GT configurations for ZCU102 prior to loading the FSBL. Hot swap or hot plug is not supported.
2. Open Vivado.
3. Open hardware manager and connect to a board with a Zynq UltraScale+ device. The following example shows connecting to a board on a remote machine, so hw\_server needs to be running on the remote machine before it can connect.

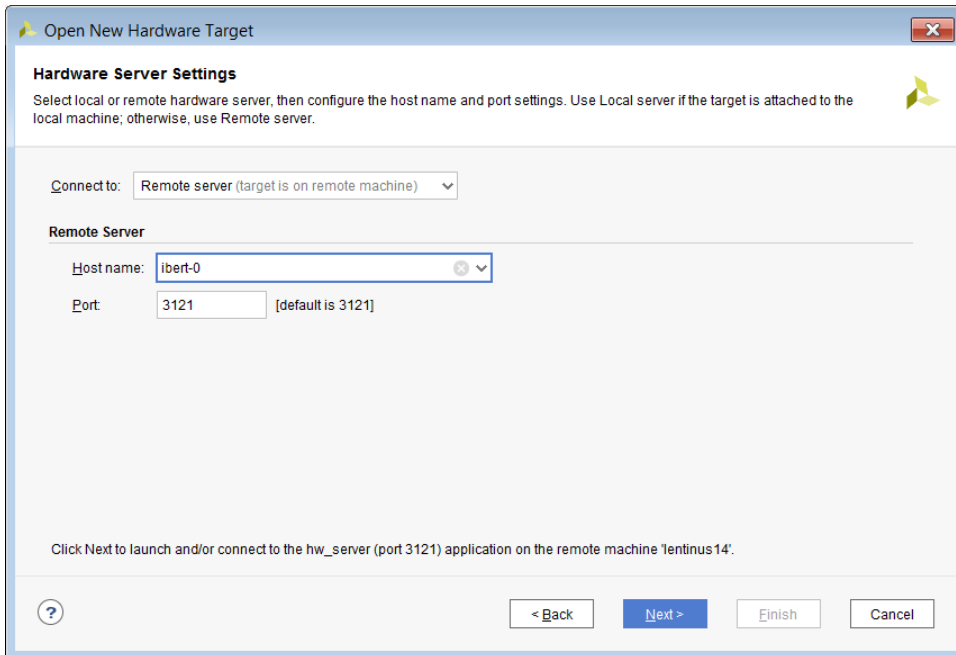

- Verify the ARM\_DAP is visible in the hardware device list and click **Next**, and then click **Finish**.

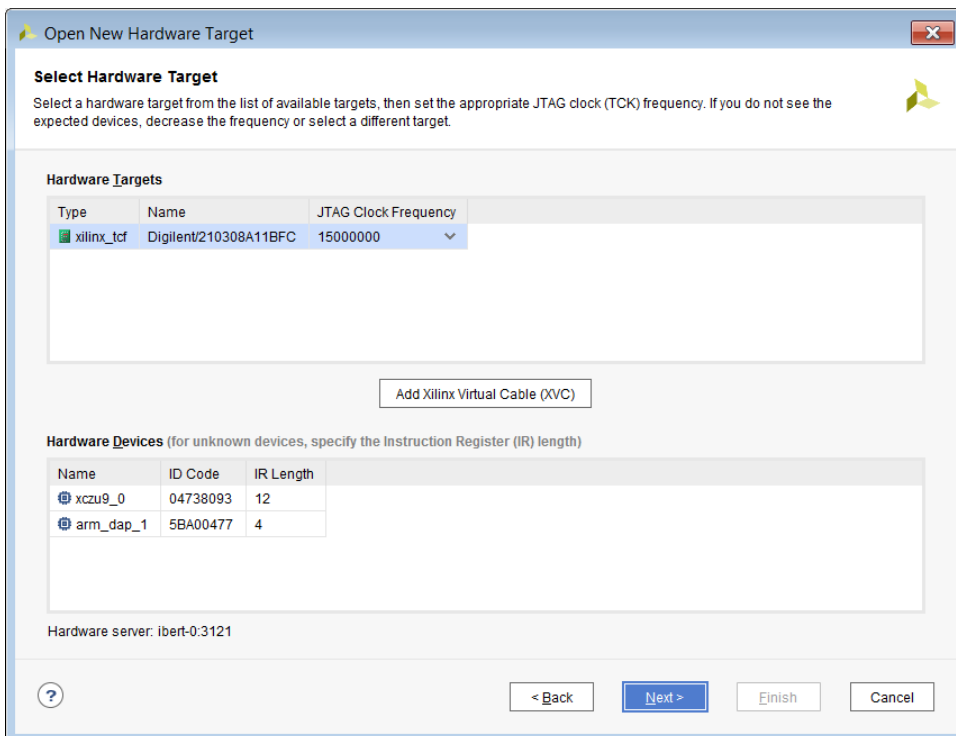

- Right-click the **ARM\_DAP** device in the hardware tree and select **Configure IBERT GTR**.

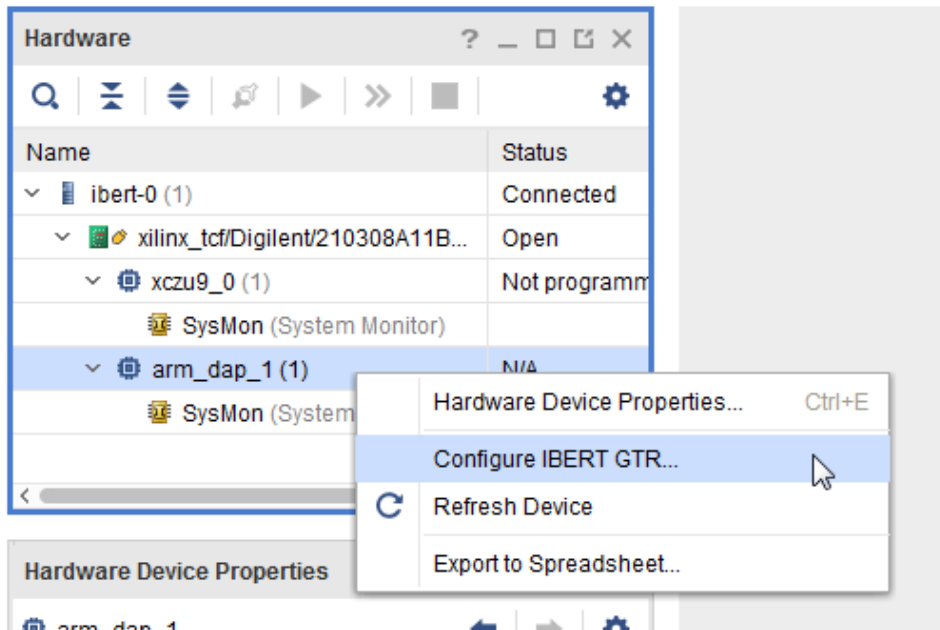

- When the dialog box opens, you must provide the FSBL ELF file created in the previous steps and optionally a configuration file (a bitstream, if your design requires one). You can also reset the system before configuring with the Reset Zynq option checked. Click **OK** when done.

**Note:** The Reset Zynq option leaves the ARM\_DAP in a bad state on early versions of Zynq UltraScale+ devices (for example, ZU9EG es1). If that occurs, power cycle the board and keep the Reset Zynq option unchecked.

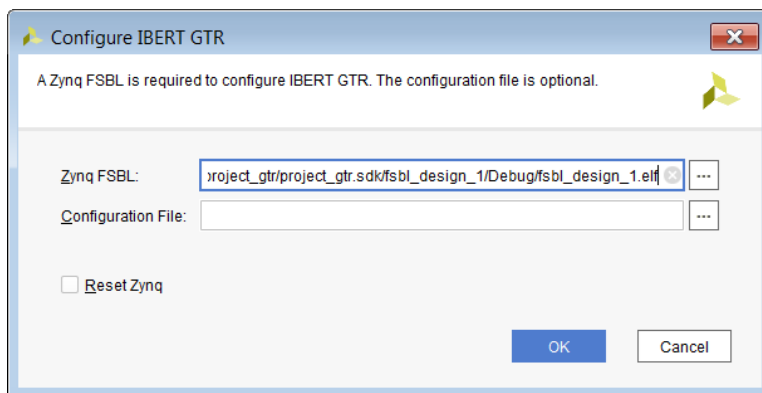

- `config_hw_sio_gts` is executed with the selected settings. `refresh_hw_device` is then called to rescan the device for new debug cores. The IBERT should be configured as shown in the following example.

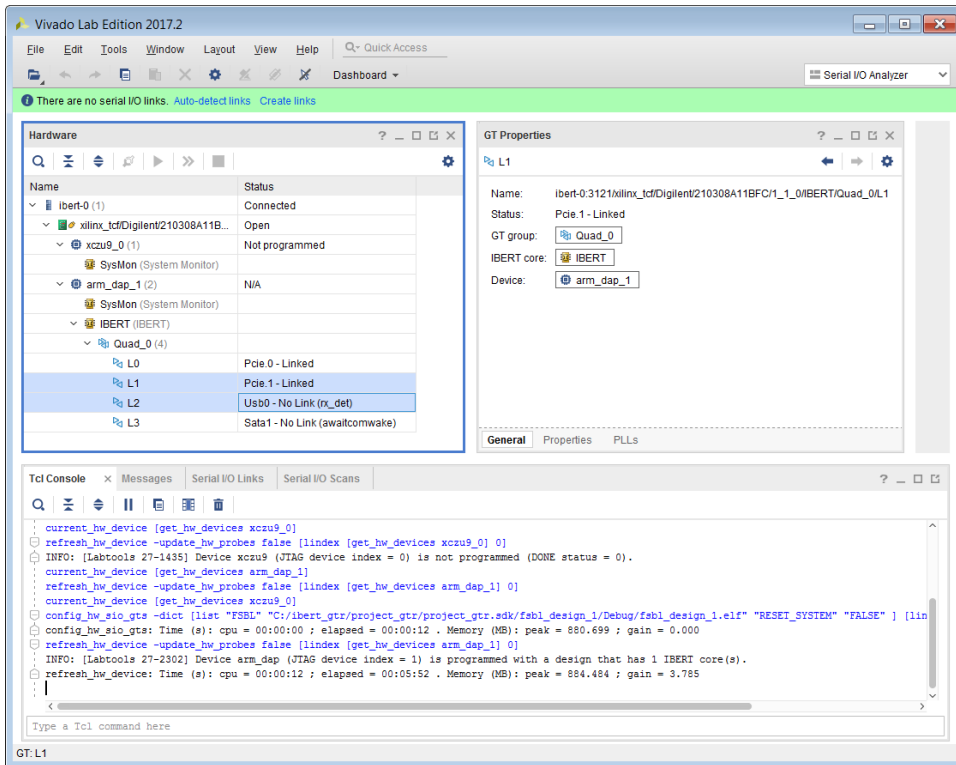

8. The Auto-detect links option does not work for PS-GTR. You can manually create links by using Create Links as shown in the following figure.

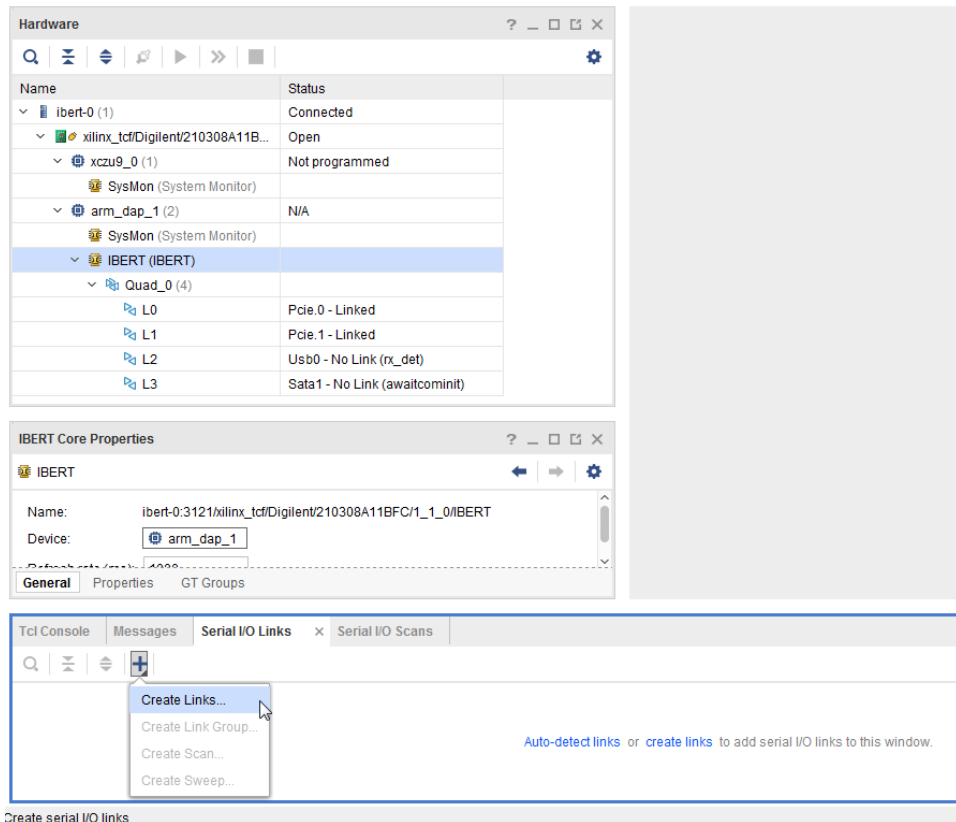



9. Create links for all four lanes with each lane's TX connected to the same lane's RX, as shown in the following figure.

Click **OK** when done.

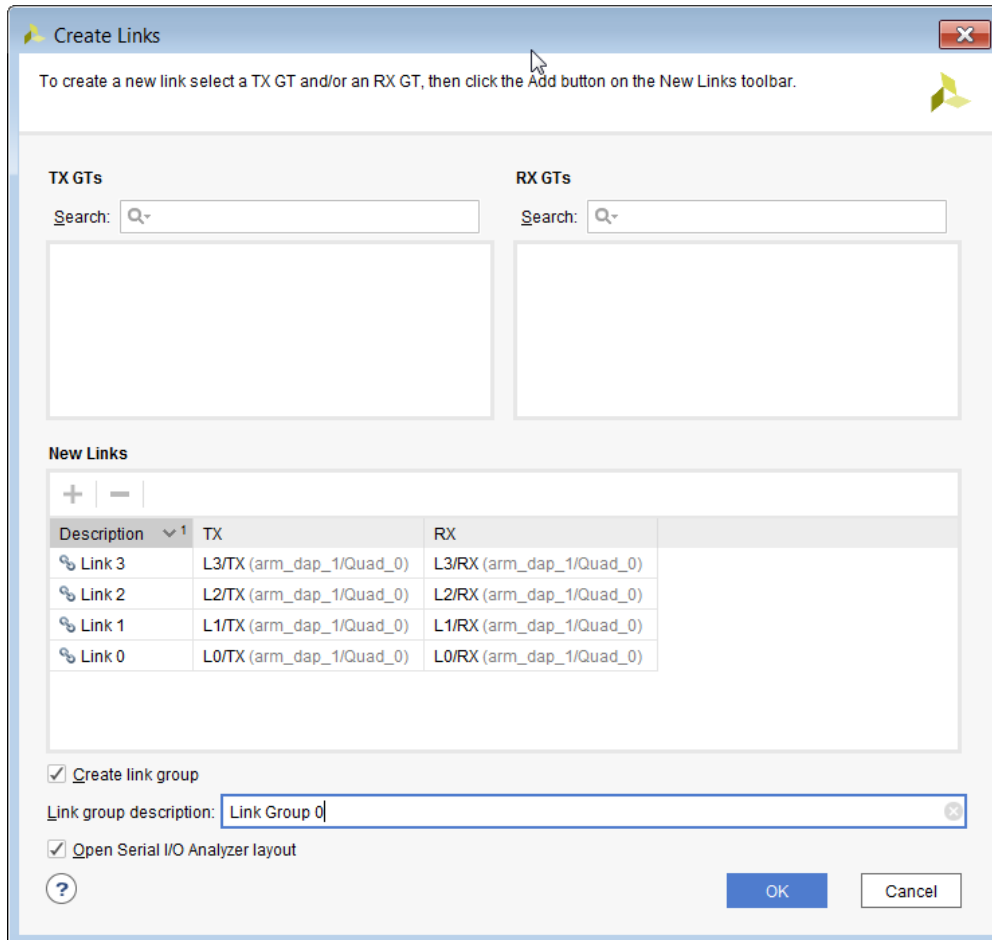

10. The following figure shows the Serial I/O Links view where Status shows all the four lanes as linked.

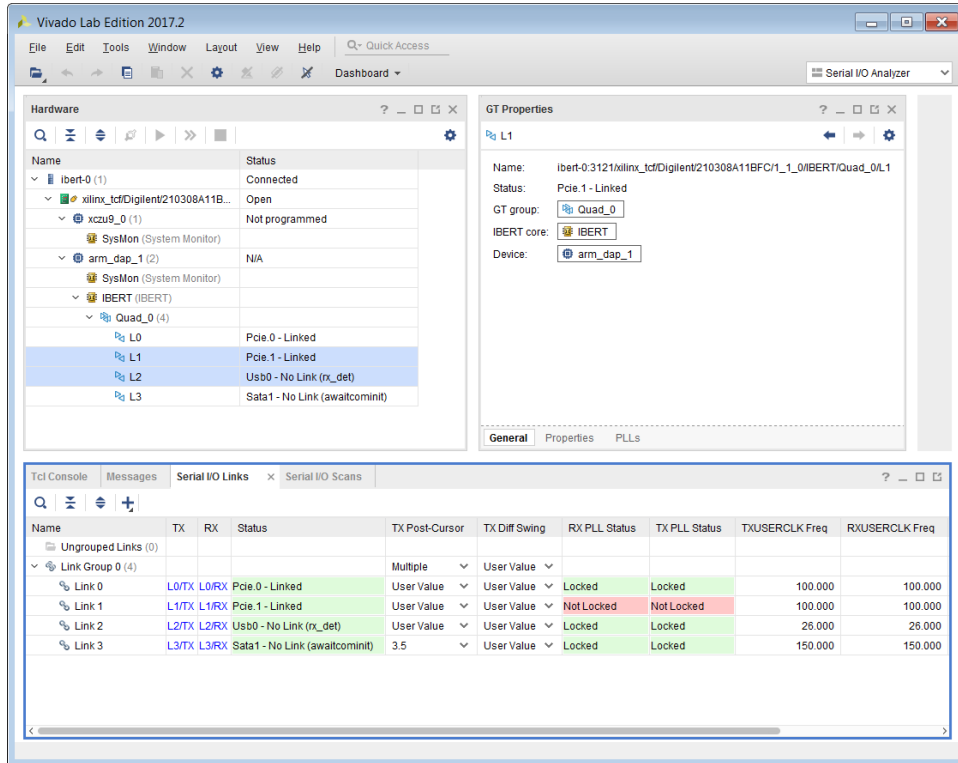

**Note:** The Link 1 PLL Status shows Not Locked, because it uses the Link 0 PLL as required by PCIe protocol.

11. Right-click on any link and select **Create Scan**.

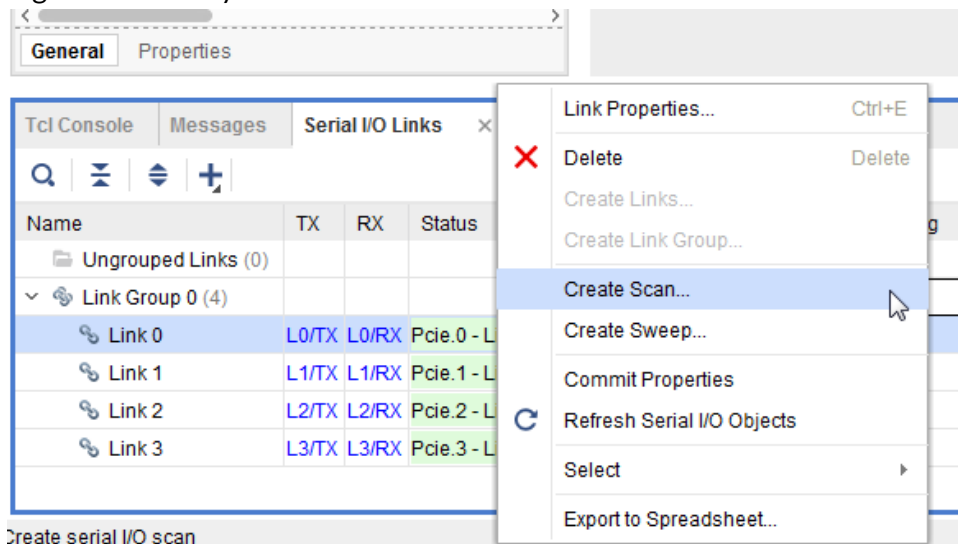

12. Select the appropriate parameters for EyeScan and perform the EyeScan. For example, the following figure is performing EyeScan on Lane L1 (Link 1). Once the EyeScan completes, the eye from -1UI to +1UI will be displayed.

**Note:** Although the Create Scan pop up shows -0.5UI to +0.5UI, the EyeScan displayed is from -1UI to +1UI.

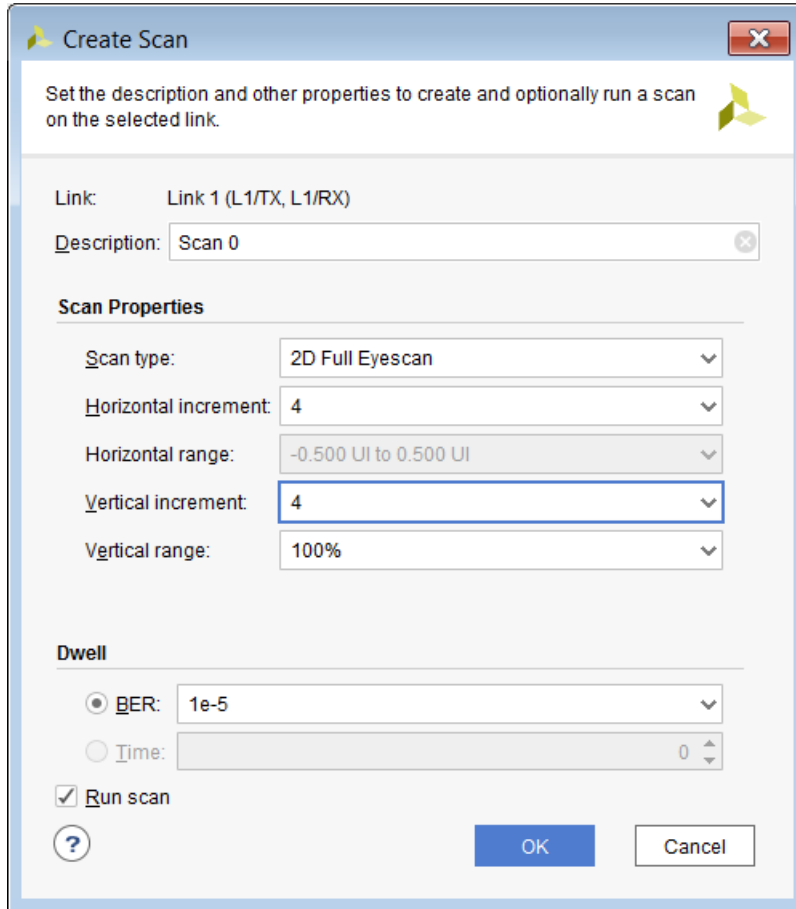

13. The following figure is a sample EyeScan performed on Lane L1.

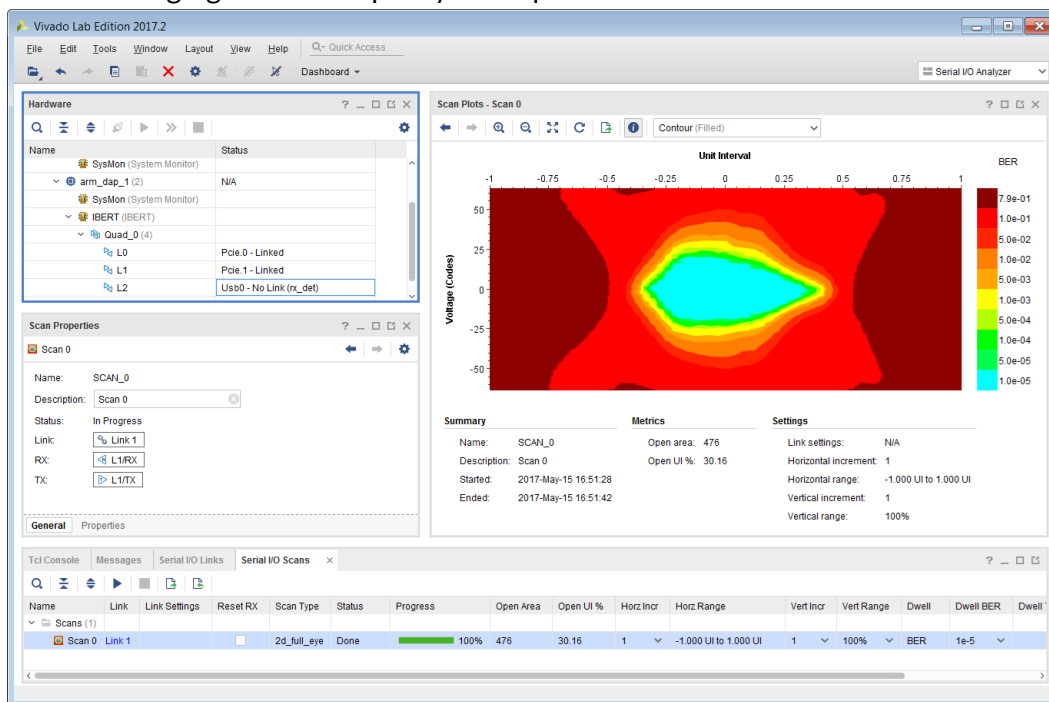

**Note:** The value reported by Open UI % is a percentage of the entire horizontal axis, which is 2UI wide for the PS-GTR transceiver.

## Troubleshooting

### Known Issues

1. By default, FSBL does not enumerate USB as that is something Linux drivers would do. To put USB in link state without Linux, a small modification is required in the FSBL C-code. This modification still does not enumerate the device, it only brings the USB into link state.
2. The EyeScan does not have a built-in time-out mechanism. If your link is poor (for example, if `L*_TM_DIG_8.EYESURF_ENABLE != 1`), the EyeScan will hang without providing a user. No results are returned in this case.
3. If the EyeScan progress is not moving, make sure the below parameters for all lanes are set for EyeScan to function correctly. Note that \* represents the lane number (as in, for Lane 0 the parameter would be L0).

Click on the lane in the hardware tree and then click on the properties tab. There's a search button you can use to find the properties below.

- a. `L*_TM_MISC3.CDR_EN_FPL = 0`
- b. `L*_TM_MISC3.CDR_EN_FFL = 0`
- c. `L*_TM_DIG_8.EYESURF_ENABLE = 1`

Also check below parameters values which ensures Eye Scan circuit is operational.

- d. `L*_PLL_LOCK = 1`
- e. `L*_TM_SAMP_STATUS4.E_SAMP_PH0_CALIB_CODE` is non-zero value
- f. `L*_TM_SAMP_STATUS5.E_SAMP_PH180_CALIB_CODE` is non-zero value

### Notes

1. As mentioned in Assumptions, IBERT PS-GTR uses the `psu_cortexr5_0` core, so no other applications should use this core.
2. TCM0 and TCM1 memory are combined to form a unified memory for IBERT PS-GTR. Any other processor core should not access this memory while IBERT PS-GTR is running.
3. The error counter is 16 bits and the sample counter is 32 bits. Each sample can have 8 bits of error count. Therefore on the edges, the error counter can saturate with a sample count value of 8192. PS-GTR does not stop the sample counter even if the error counter saturates. A `prescale=0` produces 8192 samples and thus a total samples of  $8192 * 8$  (65536) and thus the outside edges of eye could show a BER of e-01 or less depending on the prescale selected.

4. The EyeScan assumes there is link present. If there is no link, the EyeScan may not complete. Canceling the EyeScan stops the command sequence, but the state of the previous point scan will be unknown.
5. If you run EyeScan and because of no link the EyeScan does not complete, set the register L\*\_TM\_MISC\_ST\_0.EYE\_SURF\_RUN to 0 for the given lane before you run the EyeScan again.
6. If you run EyeScan on a lane that is either powered down or Display Port, it will immediately stop and the scan will be marked as incomplete. EyeScan will not work in either scenario.

# Additional Resources and Legal Notices

---

## Xilinx Resources

For support resources such as Answers, Documentation, Downloads, and Forums, see [Xilinx Support](#).

---

## Documentation Navigator and Design Hubs

Xilinx<sup>®</sup> Documentation Navigator (DocNav) provides access to Xilinx documents, videos, and support resources, which you can filter and search to find information. To open DocNav:

- From the Vivado<sup>®</sup> IDE, select **Help** → **Documentation and Tutorials**.
- On Windows, select **Start** → **All Programs** → **Xilinx Design Tools** → **DocNav**.
- At the Linux command prompt, enter `docnav`.

Xilinx Design Hubs provide links to documentation organized by design tasks and other topics, which you can use to learn key concepts and address frequently asked questions. To access the Design Hubs:

- In DocNav, click the **Design Hubs View** tab.
- On the Xilinx website, see the [Design Hubs](#) page.

**Note:** For more information on DocNav, see the [Documentation Navigator](#) page on the Xilinx website.

---

## Please Read: Important Legal Notices

The information disclosed to you hereunder (the "Materials") is provided solely for the selection and use of Xilinx products. To the maximum extent permitted by applicable law: (1) Materials are made available "AS IS" and with all faults, Xilinx hereby DISCLAIMS ALL WARRANTIES AND CONDITIONS, EXPRESS, IMPLIED, OR STATUTORY, INCLUDING BUT NOT LIMITED TO WARRANTIES OF MERCHANTABILITY, NON-INFRINGEMENT, OR FITNESS FOR ANY PARTICULAR PURPOSE; and (2) Xilinx shall not be liable (whether in contract or tort, including negligence, or under any other theory of liability) for any loss or damage of any kind or nature related to, arising under, or in connection with, the Materials (including your use of the Materials), including for any direct, indirect, special, incidental, or consequential loss or damage (including loss of data, profits, goodwill, or any type of loss or damage suffered as a result of any action brought by a third party) even if such damage or loss was reasonably foreseeable or Xilinx had been advised of the possibility of the same. Xilinx assumes no obligation to correct any errors contained in the Materials or to notify you of updates to the Materials or to product specifications. You may not reproduce, modify, distribute, or publicly display the Materials without prior written consent. Certain products are subject to the terms and conditions of Xilinx's limited warranty, please refer to Xilinx's Terms of Sale which can be viewed at <https://www.xilinx.com/legal.htm#tos>; IP cores may be subject to warranty and support terms contained in a license issued to you by Xilinx. Xilinx products are not designed or intended to be fail-safe or for use in any application requiring fail-safe performance; you assume sole risk and liability for use of Xilinx products in such critical applications, please refer to Xilinx's Terms of Sale which can be viewed at <https://www.xilinx.com/legal.htm#tos>.

### **AUTOMOTIVE APPLICATIONS DISCLAIMER**

AUTOMOTIVE PRODUCTS (IDENTIFIED AS "XA" IN THE PART NUMBER) ARE NOT WARRANTED FOR USE IN THE DEPLOYMENT OF AIRBAGS OR FOR USE IN APPLICATIONS THAT AFFECT CONTROL OF A VEHICLE ("SAFETY APPLICATION") UNLESS THERE IS A SAFETY CONCEPT OR REDUNDANCY FEATURE CONSISTENT WITH THE ISO 26262 AUTOMOTIVE SAFETY STANDARD ("SAFETY DESIGN"). CUSTOMER SHALL, PRIOR TO USING OR DISTRIBUTING ANY SYSTEMS THAT INCORPORATE PRODUCTS, THOROUGHLY TEST SUCH SYSTEMS FOR SAFETY PURPOSES. USE OF PRODUCTS IN A SAFETY APPLICATION WITHOUT A SAFETY DESIGN IS FULLY AT THE RISK OF CUSTOMER, SUBJECT ONLY TO APPLICABLE LAWS AND REGULATIONS GOVERNING LIMITATIONS ON PRODUCT LIABILITY.

## Copyright

© Copyright 2012-2021 Xilinx, Inc. Xilinx, the Xilinx logo, Alveo, Artix, Kintex, Kria, Spartan, Versal, Vitis, Virtex, Vivado, Zynq, and other designated brands included herein are trademarks of Xilinx in the United States and other countries. AMBA, AMBA Designer, Arm, ARM1176JZ-S, CoreSight, Cortex, PrimeCell, Mali, and MPCore are trademarks of Arm Limited in the EU and other countries. PCI, PCIe, and PCI Express are trademarks of PCI-SIG and used under license. All other trademarks are the property of their respective owners.