

Vivado Design Suite Tutorial

Implementation

UG986 (v2020.2) February 17, 2021



Revision History

The following table shows the revision history for this document.

Section	Revision Summary
02/17/2021 Version 2020.2	
Release updates.	Validated for Xilinx release 2020.2.
08/12/2020 Version 2020.1	
<ul style="list-style-type: none">• Figure 35: Design Runs Window after Completion• Figure 37: Incremental Reuse Report• Figure 45: Vivado IDE Showing project_bft_core Project Details	Figure Updates

Table of Contents

Revision History	2
Implementation Tutorial	5
Tutorial Design Description.....	6
Hardware and Software Requirements.....	6
Preparing the Tutorial Design Files.....	6
Chapter 1: Using Implementation Strategies	8
Step 1: Opening the Example Project.....	8
Step 2: Creating Additional Implementation Runs.....	14
Step 3: Analyzing Implementation Results.....	15
Step 4: Tightening Timing Requirements.....	17
Conclusion.....	18
Chapter 2: Using Incremental Implementation	19
Step 1: Opening the Example Project.....	19
Step 2: Viewing the Incremental Column in the Design Runs Window.....	23
Step 3: Turning on Incremental Implementation.....	24
Step 4: Compiling the Reference Design.....	26
Step 5: Making Incremental Changes.....	27
Step 6: Rerunning Synthesis and Implementation.....	29
Conclusion.....	32
Chapter 3: Manual and Directed Routing	33
Step 1: Opening the Example Project.....	33
Step 2: Performing Place and Route on the Design.....	38
Step 3: Analyzing Output Bus Timing.....	39
Step 4: Improving Bus Timing through Placement.....	44
Step 5: Using Manual Routing to Reduce Clock Skew.....	49
Step 6: Copying Routing to Other Nets.....	59
Conclusion.....	62
Chapter 4: Vivado ECO Flow	64

Step 1: Creating a Project Using the Vivado New Project Wizard	66
Step 2: Synthesizing, Implementing, and Generating the Bitstream.....	67
Step 3: Validating the Design on the Board.....	68
Step 4: Making the ECO Modifications.....	75
Step 5: Implementing the ECO Changes.....	89
Step 6: Replacing Debug Probes.....	95
Conclusion.....	98
Appendix A: Additional Resources and Legal Notices.....	99
Please Read: Important Legal Notices.....	99

Implementation Tutorial



IMPORTANT! *This tutorial requires the use of the Kintex®-7 and Kintex® UltraScale™ family of devices. You will need to update your Vivado® Design Suite tools installation if you do not have these device families installed. Refer to the Vivado Design Suite User Guide: Release Notes, Installation, and Licensing (UG973) for more information on Adding Design Tools or Devices.*

This tutorial includes four labs that demonstrate different features of the Xilinx® Vivado Design Suite implementation tool:

- Lab 1 demonstrates using implementation strategies to meet different design objectives.
- Lab 2 demonstrates the use of the incremental compile feature after making a small design change.
- Lab 3 demonstrates the use of manual placement and routing, and duplicated routing, to fine-tune the timing on the design.
- Lab 4 demonstrates the use of the Vivado ECO to make quick changes to your design post implementation.

Vivado implementation includes all steps necessary to place and route the netlist onto the FPGA device resources, while meeting the logical, physical, and timing constraints of a design.



VIDEO: *You can also learn more about implementing the design by viewing the following Quick Take videos:*

- [Vivado Quick Take Video: Implementing the Design](#)
 - [Vivado Quick Take Video: Using Incremental Implementation in Vivado](#)
-



TRAINING: *Xilinx provides training courses that can help you learn more about the concepts presented in this document. Use these links to explore related courses:*

- [Designing FPGAs Using the Vivado Design Suite 1](#)
 - [Designing FPGAs Using the Vivado Design Suite 2](#)
 - [Designing FPGAs Using the Vivado Design Suite 3](#)
 - [Designing FPGAs Using the Vivado Design Suite 4](#)
-

Tutorial Design Description

The design used for Lab 1 is the CPU Netlist example design, `project_cpu_netlist_kintex7`, provided with the Vivado Design Suite installation. This design uses a top-level EDIF netlist source file, and an XDC constraints file.

The design used for Lab 2 and Lab 3 is the BFT Core example design, `project_bft_kintex7`. This design includes both Verilog and VHDL RTL files, as well as an XDC constraints file.

The design used for Lab 4 is available as a Reference Design from the Xilinx website. See information in [Locating Design Files for Lab 4](#).

The CPU Netlist and BFT Core designs target an XC7K70T device, and the design for Lab 4 targets an XCKU040 device. Running the tutorial with small designs allows for minimal hardware requirements and enables timely completion of the tutorial, as well as minimizing data size.

Hardware and Software Requirements

This tutorial requires that the 2020.2 Vivado Design Suite software release or later is installed.

Refer to the *Vivado Design Suite User Guide: Release Notes, Installation, and Licensing* ([UG973](#)) for a complete list and description of the system and software requirements.

Preparing the Tutorial Design Files

Locating Design Files for Labs 1-3

You can find the files for Labs 1-3 in this tutorial in the Vivado Design Suite examples directory at the following location:

```
<Vivado_install_area>/Vivado/<version>/examples/Vivado_Tutorial
```

You can also extract the provided zip file, at any time, to write the tutorial files to your local directory, or to restore the files to their starting condition.

Extract the zip file contents from the software installation into any write-accessible location.

```
<Vivado_install_area>/Vivado/<version>/examples/Vivado_Tutorial.zip
```

The extracted `Vivado_Tutorial` directory is referred to as `<Extract_Dir>` in this tutorial.

Note: You will modify the tutorial design data while working through this tutorial. You should use a new copy of the original `Vivado_Tutorial` directory each time you start this tutorial

Locating Design Files for Lab 4

To access the reference design for Lab 4, do the following:

1. In your C: drive, create a folder called `/Vivado_Tutorial`.
2. Download the [reference design files](#) from the Xilinx website.
3. Unzip the tutorial source file to the `/Vivado_Tutorial` folder.

Using Implementation Strategies

In this lab, you will learn how to use implementation strategies with design runs by creating multiple implementation runs employing different strategies, and comparing the results. You will use the CPU Netlist example design that is included.

Step 1: Opening the Example Project

1. Open the Xilinx Vivado IDE.

On Linux:

1. Change to the directory where the lab materials are stored:

```
cd <Extract_Dir>/Vivado_Tutorial
```

2. Launch the Vivado IDE: `vivado`

On Windows:

1. To launch the Vivado IDE, select:

Start → **All Programs** → **Xilinx Design Tools** → **Vivado 2020.x** → **Vivado 2020.x**

Note: Your Vivado Design Suite installation might be called something other than Xilinx Design Tools on the Start menu.

Note: As an alternative, click the **Vivado 2020.x** Desktop icon to start the Vivado IDE.

2. From the Getting Started page, click **Open Example Project**.

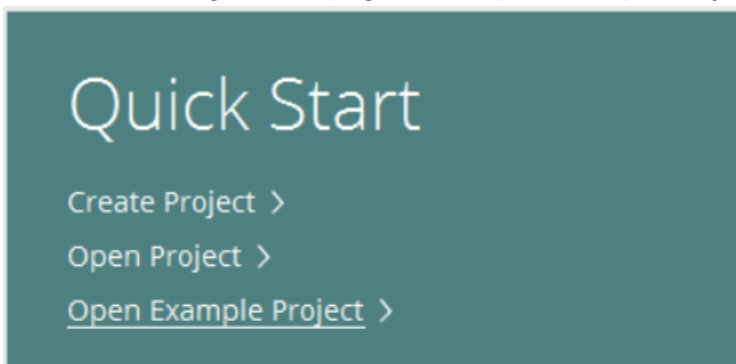

3. In the Create an Example Project page, click **Next**.

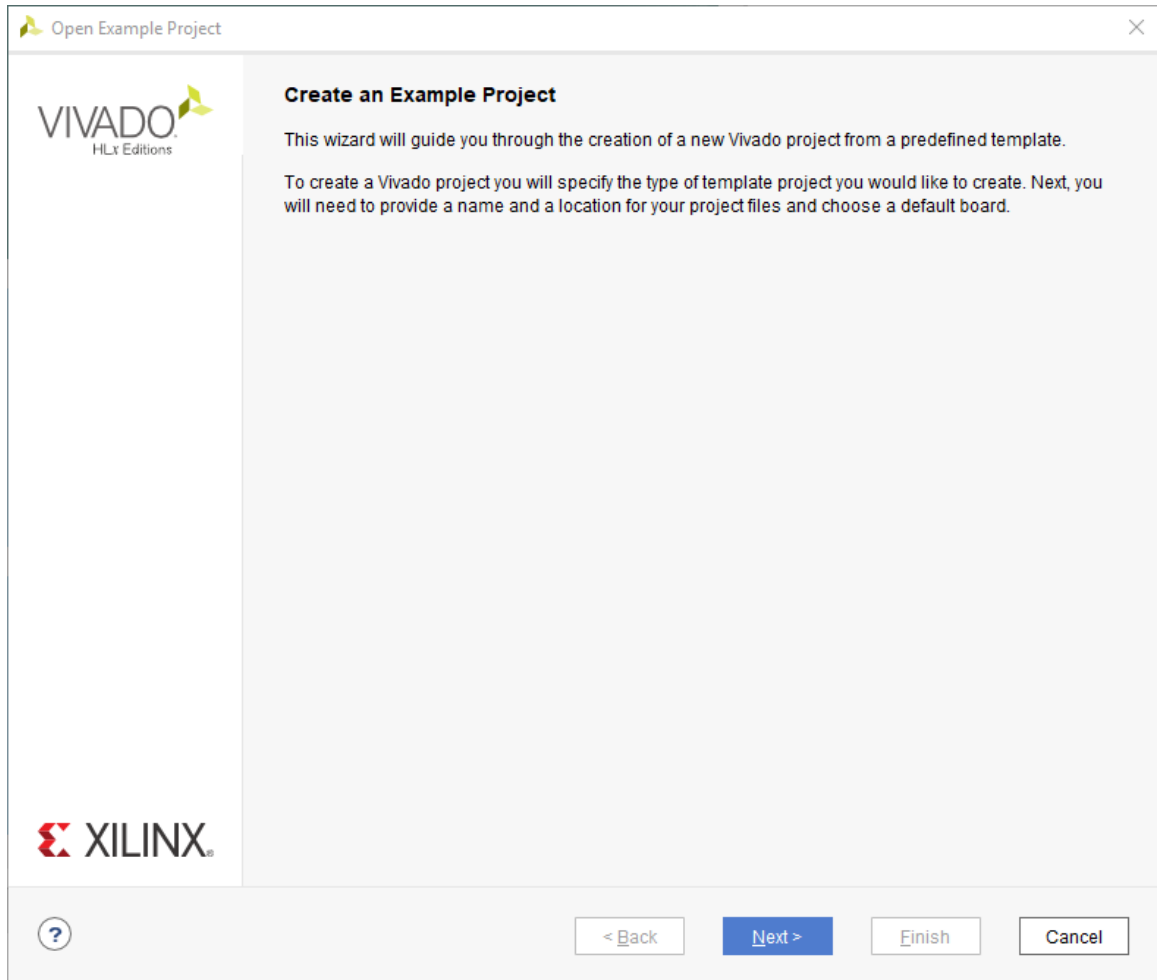

4. In the Select Project Template page, choose the **CPU (Synthesized)** project and click **Next**.

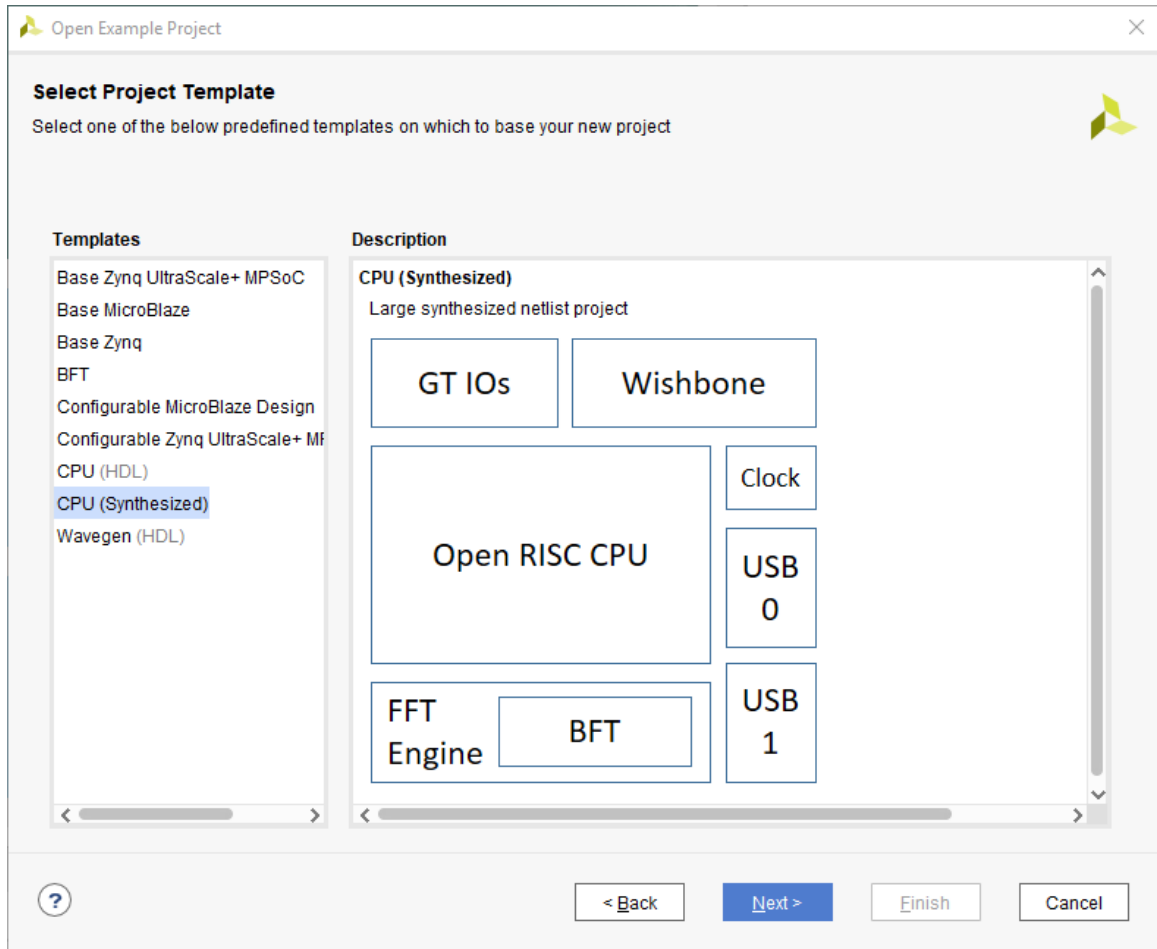

5. In the Project Name page, specify the following, and click **Next**:

- Project name: `project_cpu_netlist`
- Project location: `<Project_Dir>`

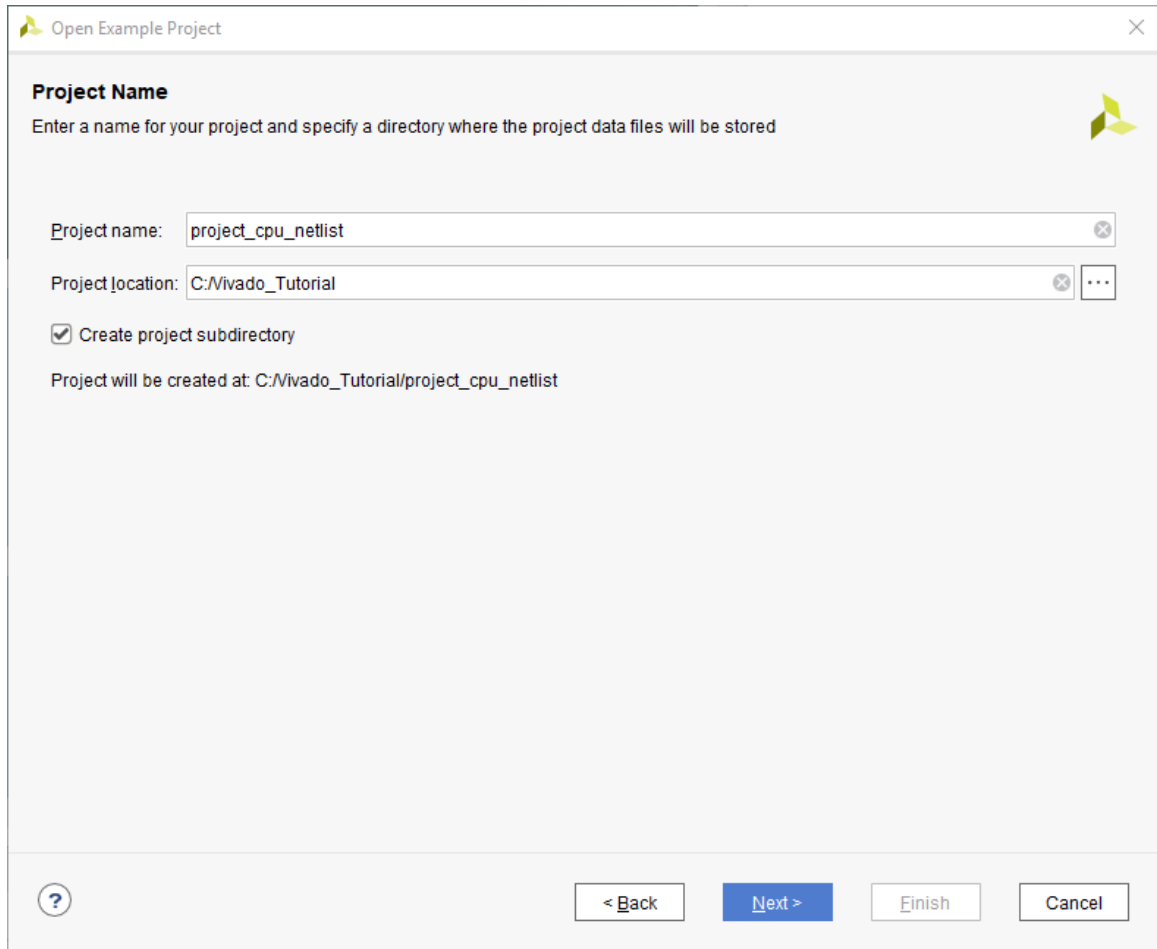

Open Example Project

Project Name
Enter a name for your project and specify a directory where the project data files will be stored

Project name:

Project location:

Create project subdirectory

Project will be created at: C:/vivado_Tutorial/project_cpu_netlist

6. In the Default Part screen, select the **xc7k70tfbg676-2** part and click **Next**.

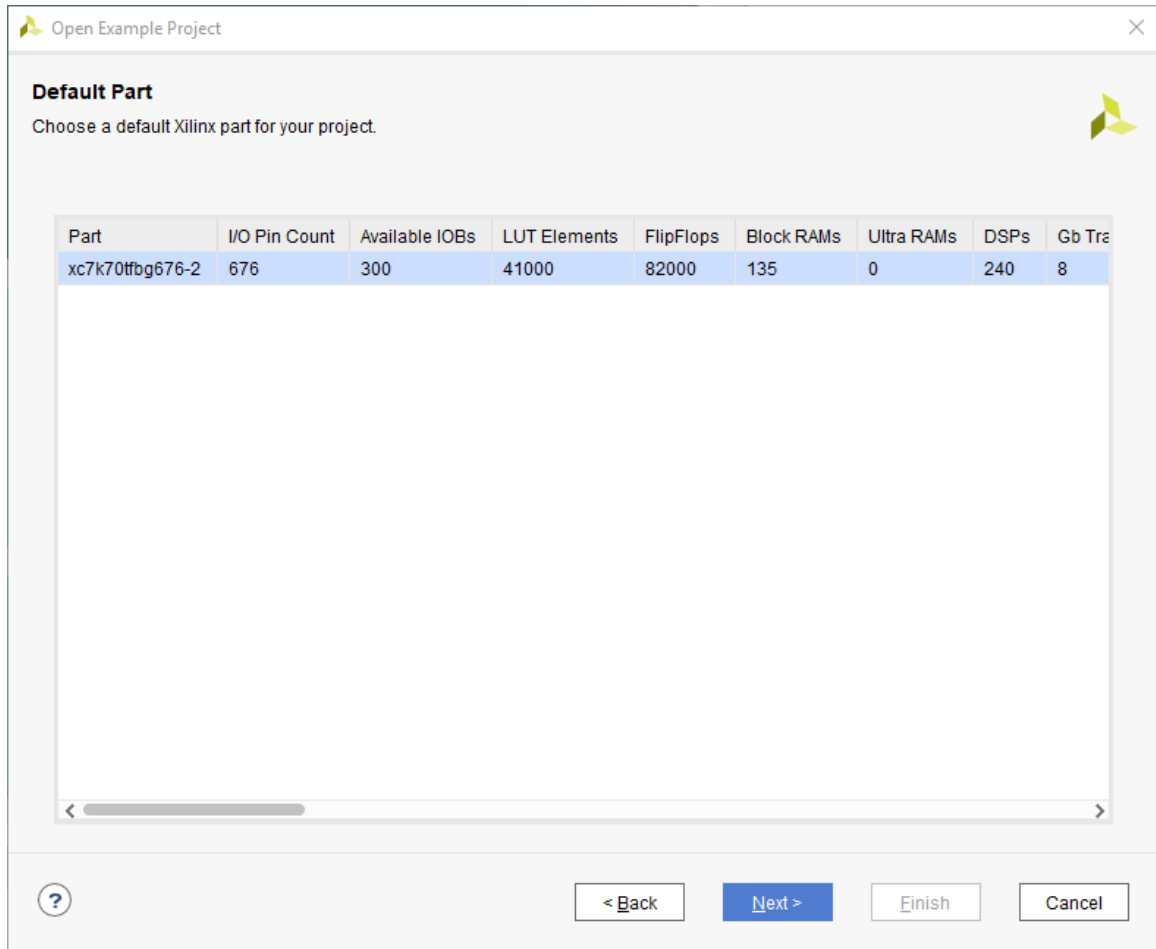

7. In the New Project Summary page, review the project details, and click **Finish**.

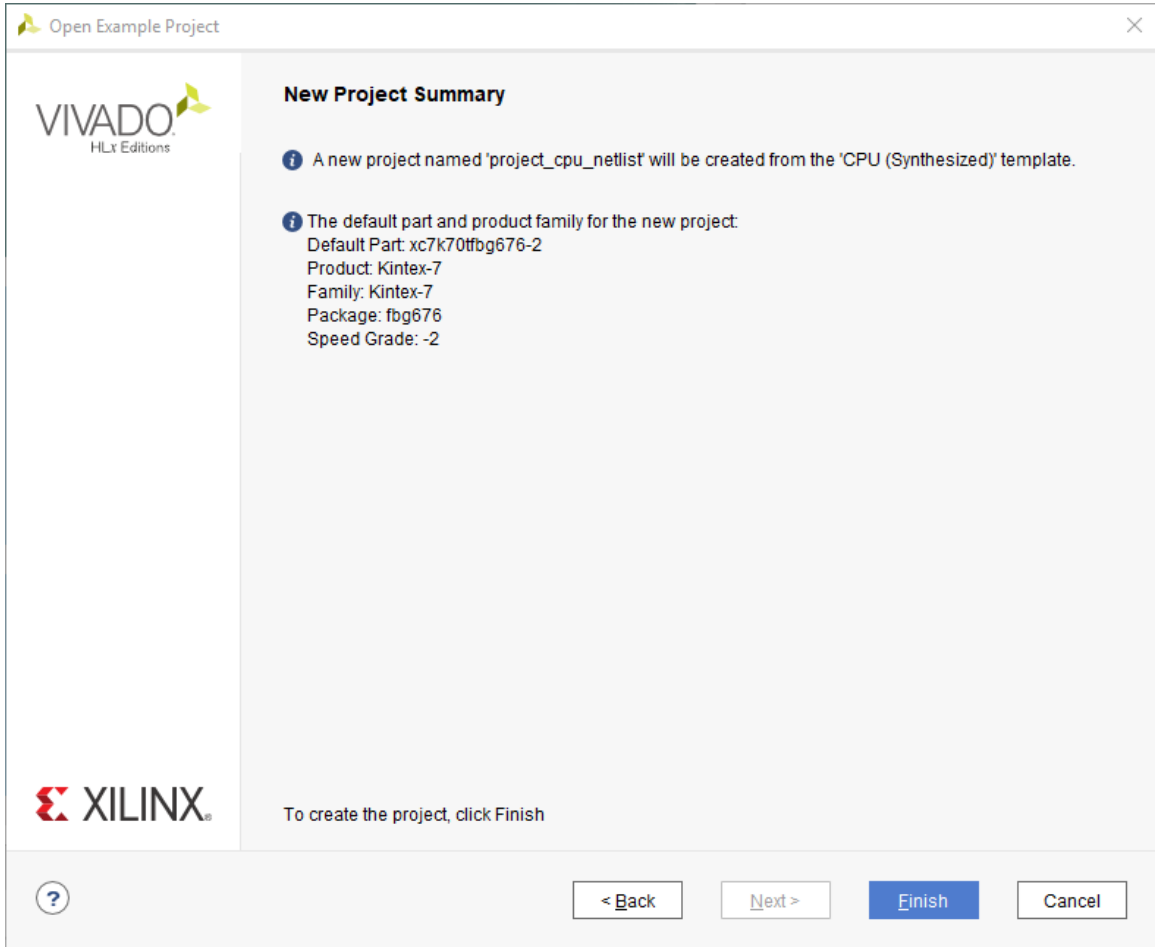

The Vivado IDE opens with the default view.

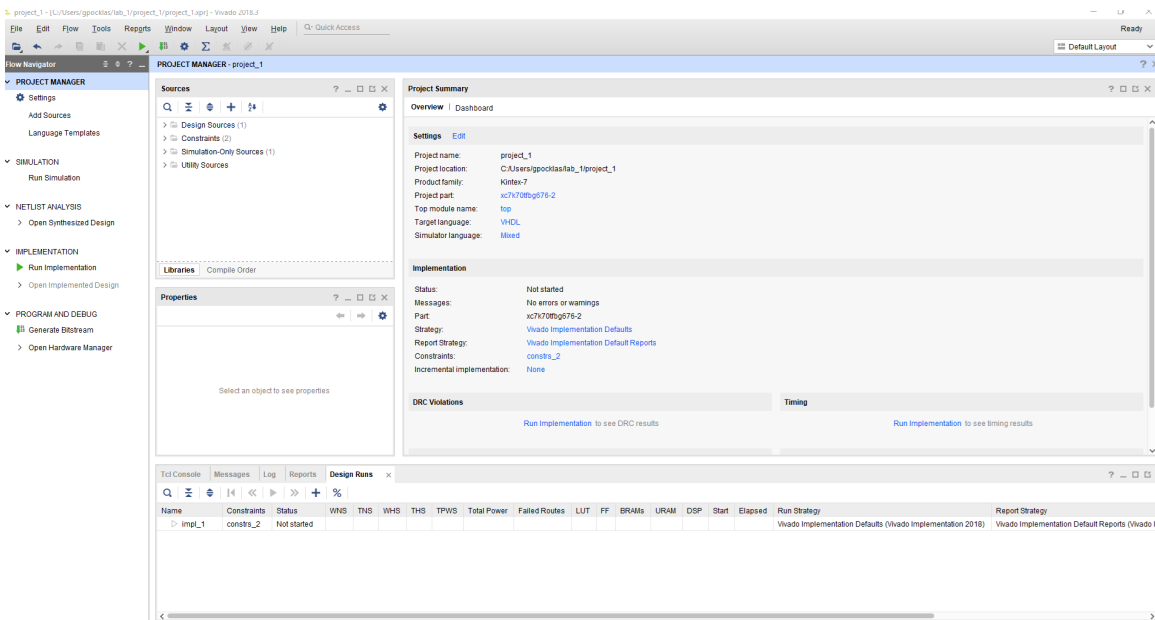

Step 2: Creating Additional Implementation Runs

The project contains previously defined implementation runs as seen in the Design Runs window of the Vivado IDE. You will create new implementation runs and change the implementation strategies used by these new runs.

1. From the main menu, select **Flow** → **Create Runs**.
2. The Create New Runs wizard opens.
3. Click **Next** to open the Configure Implementation Runs screen.

The screen appears with a new implementation run defined. You can configure this run and add other runs as well.

4. In the Run Strategy drop-down menu, select **Performance_Explore** as the strategy for the run.
5. Click the **Add**  button twice to create two additional runs.
6. Select **Flow_RunPhysOpt** as the Run Strategy for the `impl_3` run.
7. Select **Flow_RuntimeOptimized** as the Run Strategy for the `impl_4` run.

The Configure Implementation Runs screen now displays three new implementations along with the strategy you selected for each, as shown in the following figure.

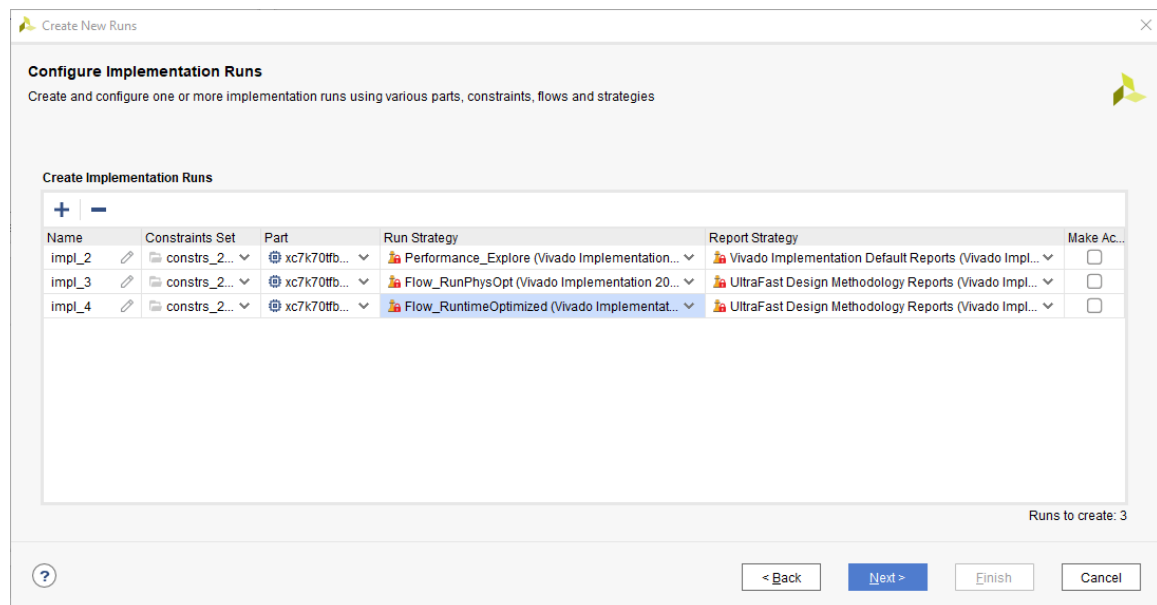



8. Click **Next** to open the Launch Options screen.
9. Select **Do not launch now**, and click **Next** to view the Create New Runs Summary.

10. In the Create New Runs Summary page, click **Finish**.

Step 3: Analyzing Implementation Results

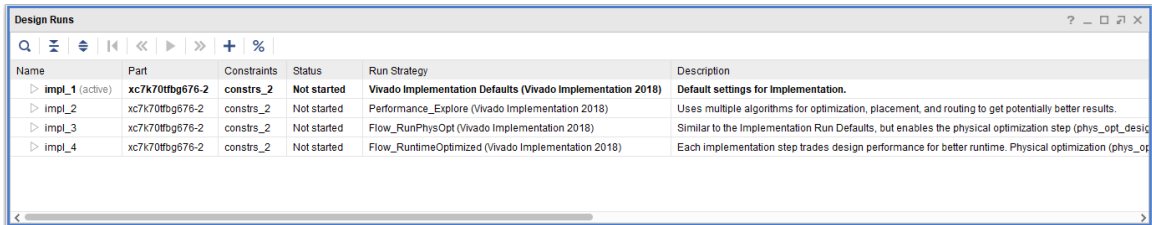
1. In the Design Runs window, select all the implementation runs.



2. Click the **Launch Runs** toolbar button .
3. In the Launch Runs dialog box, select **Launch runs on local host** and Number of jobs: **4**, as shown in the following figure. The number of jobs is the maximum number of implementation runs for parallel execution. Up to 4 jobs may run in parallel depending on number of available processors with remaining jobs put into a queue.

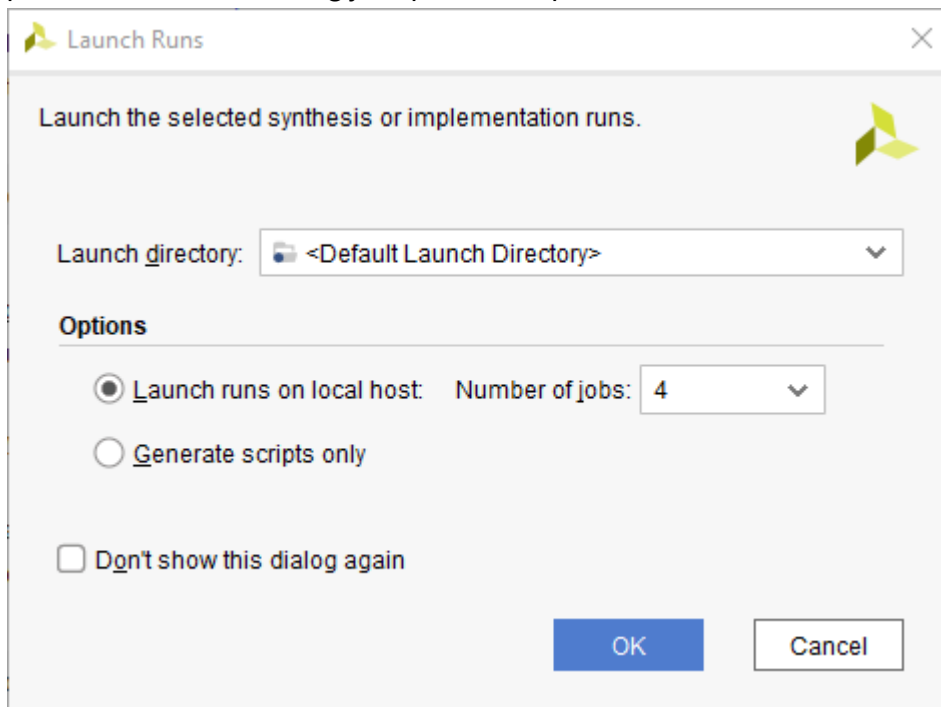

4. Click **OK**.

Two runs launch simultaneously, with the remaining runs going into a queue. In this example, Vivado is running on a machine with only 2 available processors.

Name	Part	Constraints	Strategy	Status	Progress	WNS	TNS	WHS	THS	TPWS	Total Power
impl_1 (active)	xc7k70tbg676-2	constrs_2	Vivado Implementation Defaults (Vivado Implementation 2017)	Running place_design...	50%						
impl_2	xc7k70tbg676-2	constrs_2	Performance_Explore (Vivado Implementation 2017)	Running place_design...	40%						
impl_3	xc7k70tbg676-2	constrs_2	Flow_RunPhysOpt (Vivado Implementation 2017)	Queued...	0%						
impl_4	xc7k70tbg676-2	constrs_2	Flow_RuntimeOptimized (Vivado Implementation 2017)	Queued...	0%						

When the active run, `impl_1`, completes, examine the Project Summary. The Project Summary reflects the status and the results of the active run. When the active run (`impl_1`) is complete, the Implementation Completed dialog box opens.

- Click **Cancel** to close the dialog box.

Note: The implementation utilization results display as a bar graph at the bottom of the summary page (you might need to scroll down), as shown in the following figure.

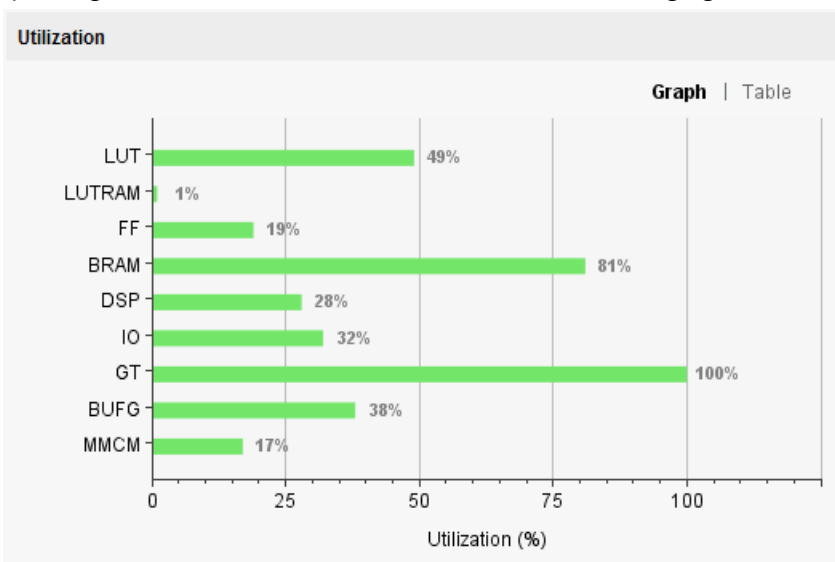

When you open an implementation run, the `report_power` and the `report_timing_summary` results are automatically opened for the run in a new tab in the Results Window.

- When all the implementation runs are complete, select the **Design Runs** window.
- Right-click the `impl_3` run in the Design Runs window, and select **Make Active** from the popup menu.

The Project Summary now displays the status and results of the new active run, `impl_3`.

Name	Part	Constraints	Status	Run Strategy	Elapsed	WNS	Description
impl_1	xc7k70tbg676-2	constrs_2	route_design Complete!	Vivado Implementation Defaults (Vivado Implementation 2018)	00:07:01	0.105	Default settings for implementation.
impl_2	xc7k70tbg676-2	constrs_2	route_design Complete!	Performance_Explore (Vivado Implementation 2018)	00:07:10	0.105	Uses multiple algorithms for optimization, placement, and routing.
impl_3 (active)	xc7k70tbg676-2	constrs_2	route_design Complete!	Flow_RunPhysOpt (Vivado Implementation 2018)	00:07:36	0.105	Similar to the Implementation Run Defaults, but enables the performance optimization.
impl_4	xc7k70tbg676-2	constrs_2	route_design Complete!	Flow_RuntimeOptimized (Vivado Implementation 2018)	00:06:54	0.799	Each implementation step trades design performance for better timing.

8. Compare the results for the completed runs in the Design Runs window, as shown in the previous figure.
 - The `Flow_RuntimeOptimized` strategy in `impl_4` completed in the least amount of time, as you can see in the Elapsed time column.
 - The WNS column shows that all runs met the timing requirements.

Step 4: Tightening Timing Requirements

To examine the impact of the `Performance_Explore` strategy on meeting timing, you will change the timing constraints to make timing closure more challenging.

1. In the Sources window, double-click the `top_full.xdc` file in the `constrs_2` constraint set.

The constraints file opens in the Vivado IDE text editor.

```

1  # Define the top level system clock of the design
2  create_clock -period 10 -name sysClk [get_ports sysClk]
3
4  # Define the clocks for the GTX blocks
5  create_clock -name gt0_txusrclk_i -period 12.8 [get_pins mgtEngine/ROCKETIO_WRAPPER_T
6  create_clock -name gt2_txusrclk_i -period 12.8 [get_pins mgtEngine/ROCKETIO_WRAPPER_T
7  create_clock -name gt4_txusrclk_i -period 12.8 [get_pins mgtEngine/ROCKETIO_WRAPPER_T
8  create_clock -name gt6_txusrclk_i -period 12.8 [get_pins mgtEngine/ROCKETIO_WRAPPER_T
9
10
    
```

2. On line 2, change the period of the `create_clock` constraint from 10 ns to 7.35 ns. The new constraint should read as follows:

```
create_clock -period 7.35 -name sysClk [get_ports sysClk]
```

3. Save the changes by clicking the Save File button in the toolbar of the text editor.

Note: Saving the constraints file changes the status of all runs using that constraints file from “Complete” to “Out-of-date,” as seen in the Design Runs window.

Name	Part	Constraints	Status	Run Strategy	Elapsed	WNS	Description
impl_1	xc7k70tbg676-2	constrs_2	Implementation Out-of-date	Vivado Implementation Defaults (Vivado Implementation 2018)	00:07:01	0.105	Default settings for implementation.
impl_2	xc7k70tbg676-2	constrs_2	Implementation Out-of-date	Performance_Explore (Vivado Implementation 2018)	00:07:10	0.105	Uses multiple algorithms for optimization, placement, and routing.
impl_3 (active)	xc7k70tbg676-2	constrs_2	Implementation Out-of-date	Flow_RunPhysOpt (Vivado Implementation 2018)	00:07:36	0.105	Similar to the Implementation Run Defaults, but enables the performance_Explore strategy.
impl_4	xc7k70tbg676-2	constrs_2	Implementation Out-of-date	Flow_RuntimeOptimized (Vivado Implementation 2018)	00:06:54	0.799	Each implementation step trades design performance for better timing closure.

4. In the Design Runs window, select all runs and click the Reset Runs button.

- In the Reset Runs dialog box, click **Reset**.

This directs the Vivado Design Suite to remove all files associated with the selected runs from the project directory. The status of all runs changes from “Out-of-date” to “Not started.”

- With all runs selected in the Design Runs window, click the Launch Runs  button.

The Launch Selected Runs window opens.



TIP: You can also launch runs without resetting them first. If the runs are out of date, the Reset Runs dialog box displays. In this dialog box, you can reset the runs before they are launched.

- Select **Launch runs on local host** and Number of jobs: **2** and click **OK**.

When the active run (`impl_3`) completes, the Implementation Completed dialog box opens.

- Click **Cancel** to close the dialog box.

- Compare the Elapsed time for each run in the Design Runs window, as seen in the following figure.

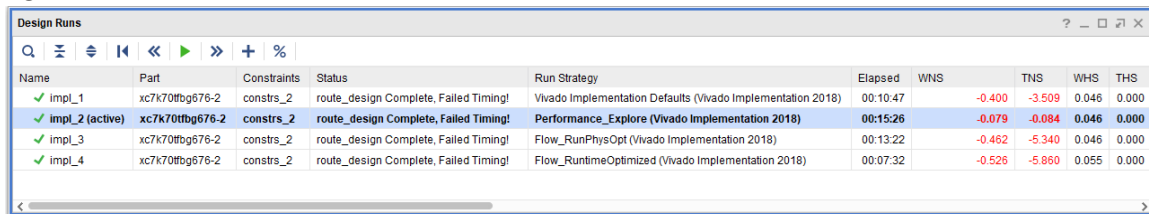

Name	Part	Constraints	Status	Run Strategy	Elapsed	WNS	TNS	WHS	THS
✓ impl_1	xc7k70tbg676-2	constrs_2	route_design Complete, Failed Timing!	Vivado Implementation Defaults (Vivado Implementation 2018)	00:10:47	-0.400	-3.509	0.046	0.000
✓ impl_2 (active)	xc7k70tbg676-2	constrs_2	route_design Complete, Failed Timing!	Performance_Explore (Vivado Implementation 2018)	00:15:26	-0.079	-0.084	0.046	0.000
✓ impl_3	xc7k70tbg676-2	constrs_2	route_design Complete, Failed Timing!	Flow_RunPhysOpt (Vivado Implementation 2018)	00:13:22	-0.462	-5.340	0.046	0.000
✓ impl_4	xc7k70tbg676-2	constrs_2	route_design Complete, Failed Timing!	Flow_RuntimeOptimized (Vivado Implementation 2018)	00:07:32	-0.526	-5.860	0.055	0.000

- Notice that the `impl_2` run, using the `Performance_Explore` strategy is closest to meeting timing, but also took the most time to complete.

Note: Reserve the `Performance_Explore` strategy for designs that have challenging timing constraints and fail to meet timing with the Implementation Defaults strategy.

Conclusion

In this lab, you learned how to define multiple implementation runs to employ different strategies to resolve timing. You have seen how some strategies trade performance for results, and learned how to use those strategies in a more challenging design.

This concludes Lab 1. If you plan to continue directly to Lab 2, keep the Vivado IDE open and close the current project. If you do not plan to continue, you can exit the Vivado Design Suite.

Using Incremental Implementation

Incremental implementation can be used when a user wants to get faster implementation compile times and more consistent implementation results. Incremental implementation is a flow that achieves greater consistency of results and faster implementation compile times. It should be used when a design is relatively stable and only small changes are required.

After resynthesizing a design with minor changes, the incremental compile flow can speed up placement and routing by reusing results from a prior design iteration. This can help you preserve timing closure while allowing you to quickly implement incremental changes to the design.

In this lab, you use the BFT example design that is included in the Vivado[®] Design Suite, to learn how to use the Incremental Implementation. Refer to the *Vivado Design Suite User Guide: Implementation* ([UG904](#)) to learn more about Incremental Compile.

Step 1: Opening the Example Project

1. Start by loading Vivado IDE by doing one of the following:
 - Launch the Vivado IDE from the icon on the Windows desktop.
 - Type `vivado` from a command terminal.
2. From the Getting Started page, click **Open Example Project**.

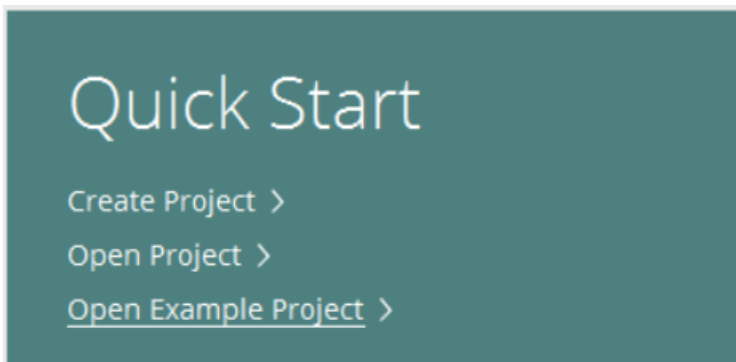

3. In the Create an Example Project page, click **Next**.

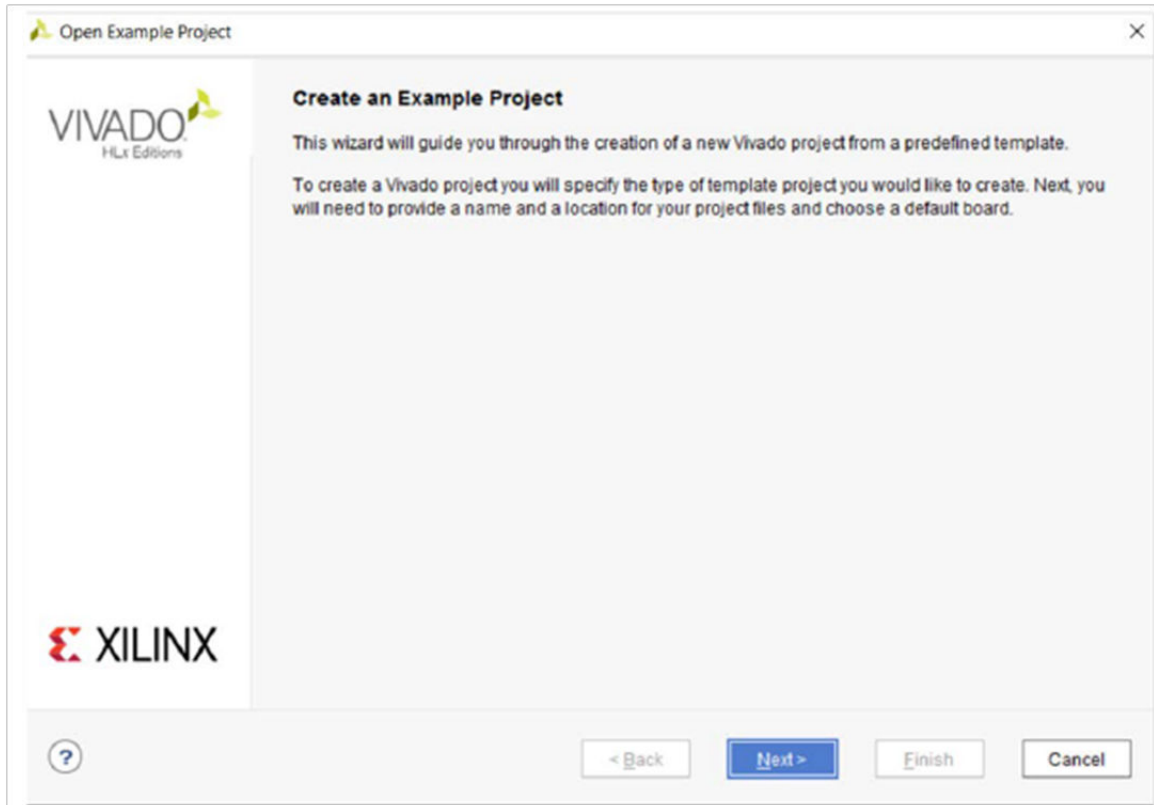

4. In the Select Project Template page, select the **BFT (Small RTL project)** design, and click **Next**.

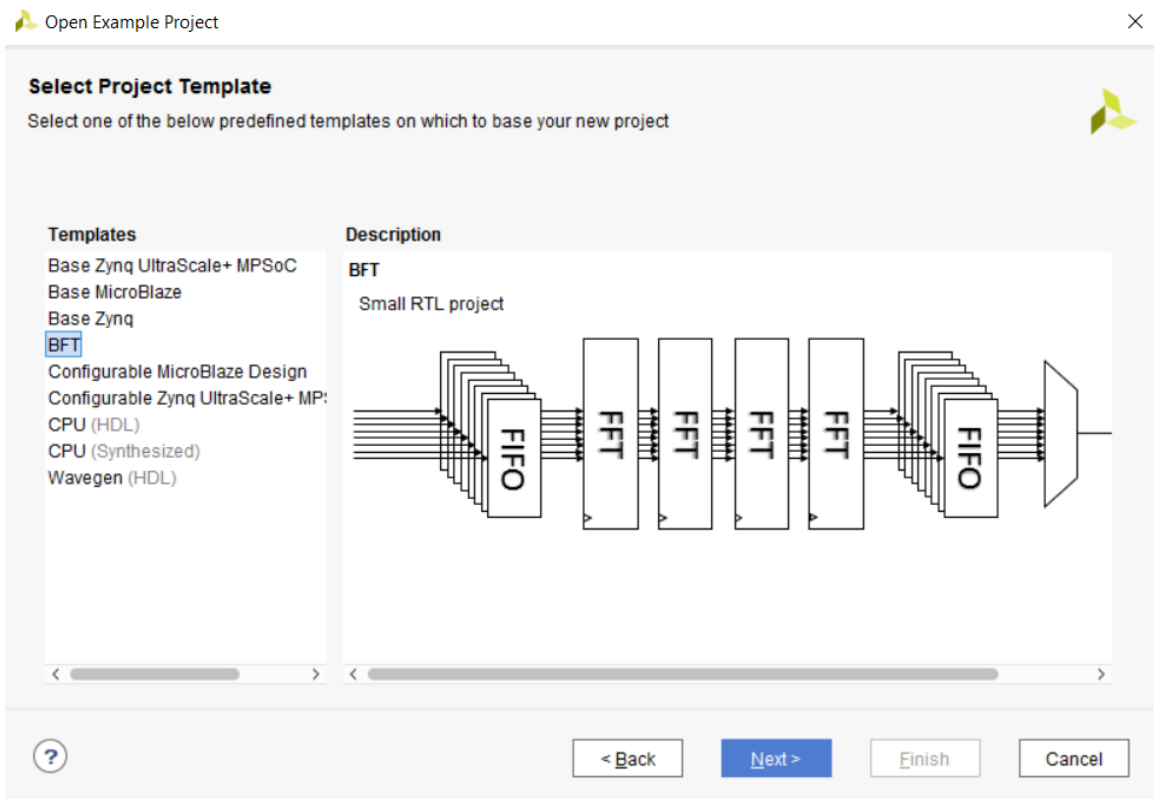

5. In the Project Name page, specify the following, and click **Next**:

- Project name: `project_bft_core_hdl`
- Project location: `<Project_Dir>`

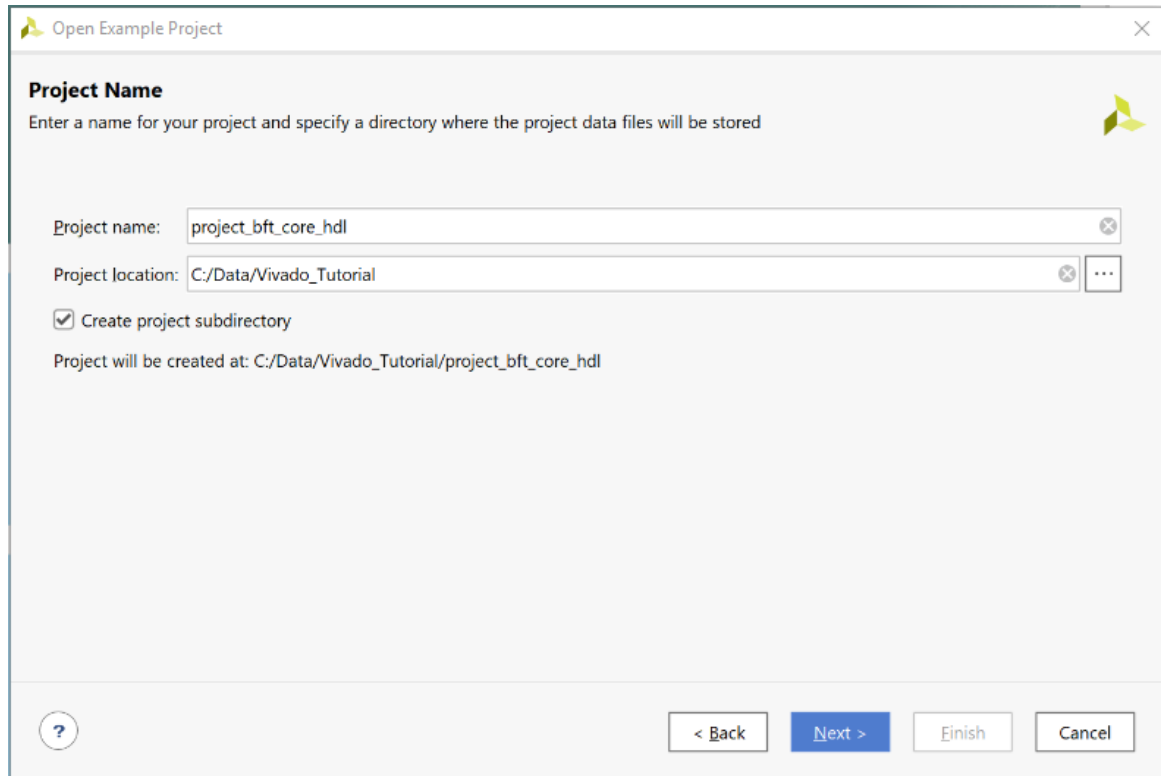

Project Name
Enter a name for your project and specify a directory where the project data files will be stored

Project name:

Project location:

Create project subdirectory

Project will be created at: C:/Data/Vivado_Tutorial/project_bft_core_hdl

6. In the Default Part page, select the `xc7k70tfbg484-2` part, and click **Next**.

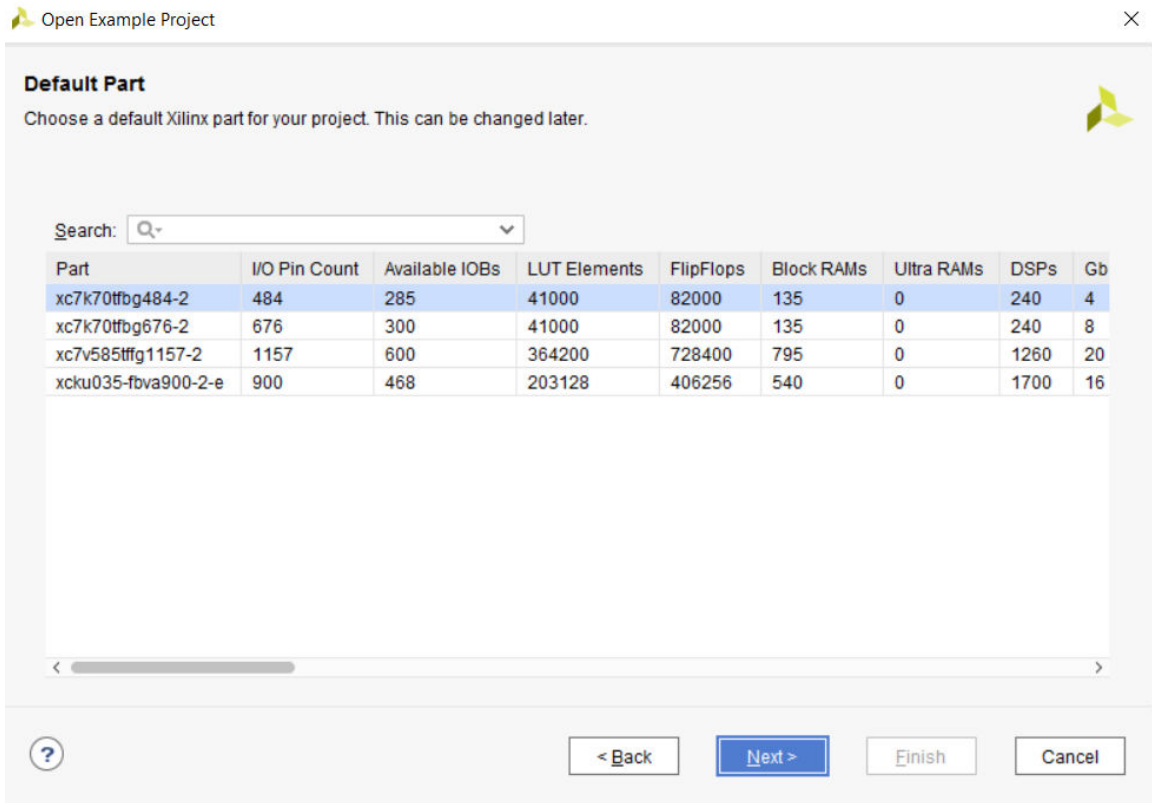

7. In the New Project Summary page, review the project details, and click **Finish**.

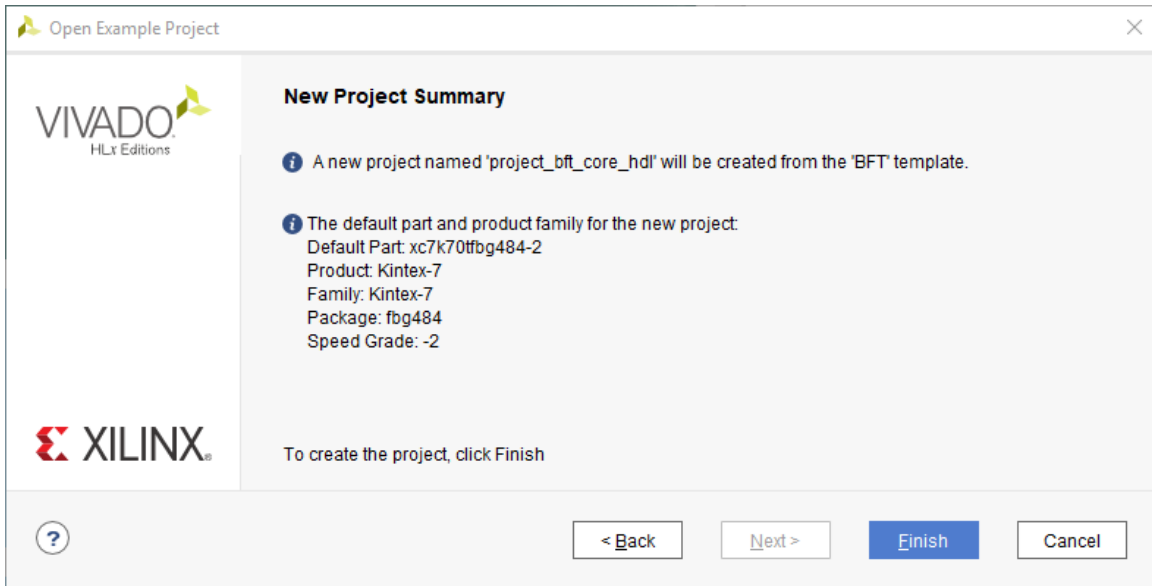

The Vivado IDE opens with the default view.

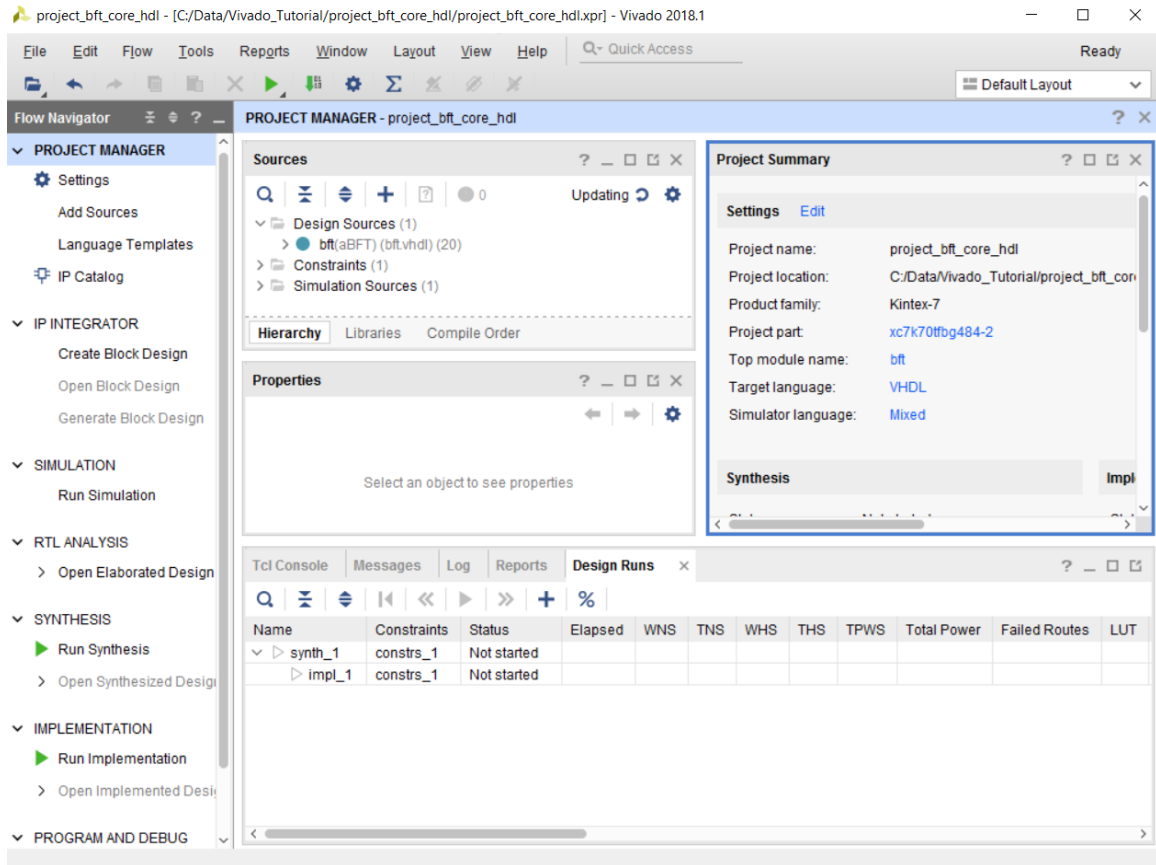

Step 2: Viewing the Incremental Column in the Design Runs Window

In the Design Runs window, right-click on any of the column headings and enable the Incremental column if it is not already enabled, as shown in the following figures:

Figure 1: Enabling Incremental Heading

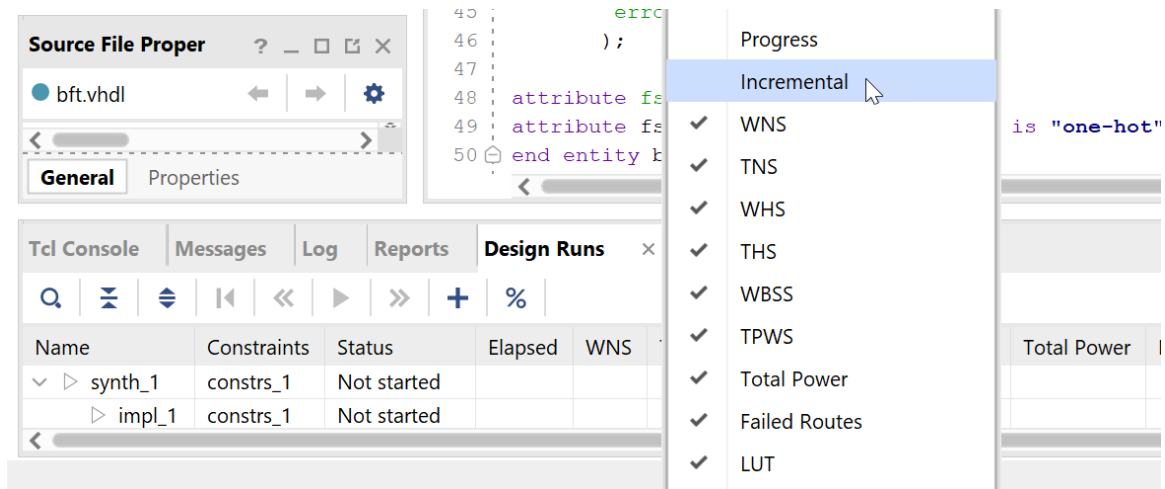
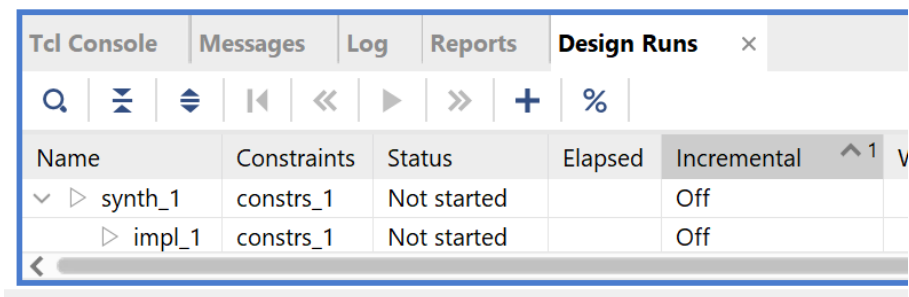

Figure 2: Design Runs Window



This column shows how the incremental flow was used. The information is also available in the messages in the Vivado log file.

Step 3: Turning on Incremental Implementation

1. Right-click on the `impl_1` run and select **Set Incremental Implementation**.

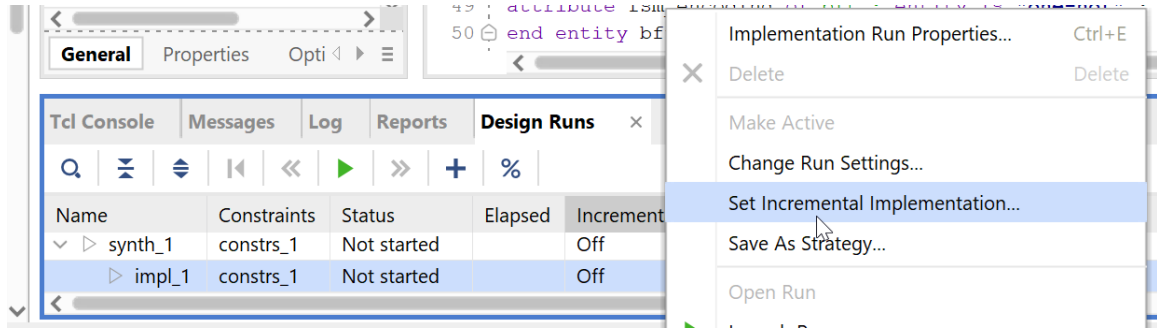

- In the Incremental Implementation dialog box, select **Automatically use the checkpoint from the previous run**.

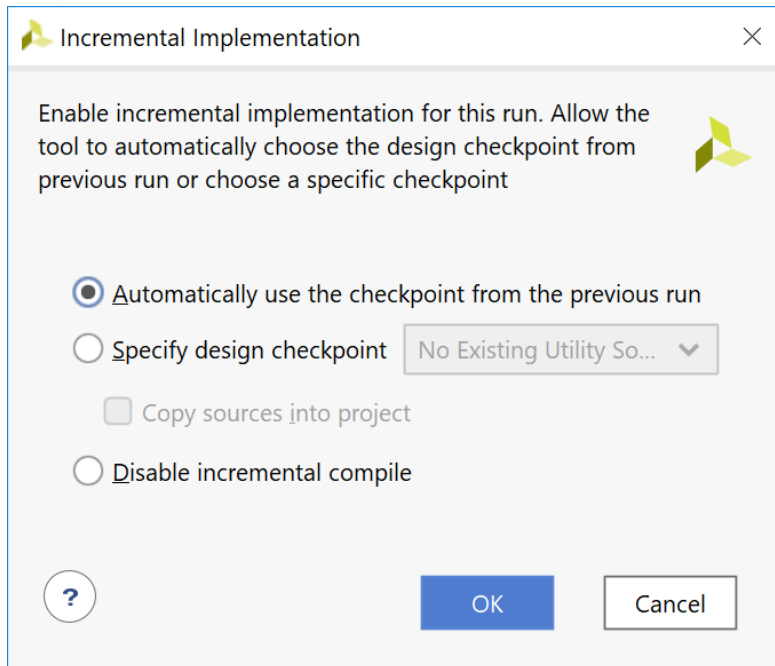

This dialog box can be opened from many places inside the Vivado IDE. These include the Implementation Run Options window and the Project Summary. The same functionality can also be built into scripts via Tcl commands.

- To enable automatic checkpoint selection via Tcl, use the following command:

```
set_property AUTO_INCREMENTAL_CHECKPOINT 1 [get_runs impl_1]
```

After this is done, you should see the Incremental Column in the Design Runs window update to Auto(skipped). This setting indicates that Auto mode is enabled but that Incremental Implementation has not been run.

Tcl Console Messages Log Reports Design Runs ×				
🔍 ⚙️ ⚙️ ⏪ ⏩ ▶️ ⏴ ⏵ + %				
Name	Constraints	Status	Elapsed	Incremental ^ 1
▼ ▷ synth_1	constrs_1	Not started		Off
▷ impl_1	constrs_1	Not started		Auto(Skipped)

It is possible to select your own checkpoint, which is desirable when the checkpoint must not be updated or lower thresholds for reuse are OK to use. It is your responsibility to manage the suitability of the checkpoint in this case.

Step 4: Compiling the Reference Design

1. From the Flow Navigator, select **Run Implementation**.
2. In the Missing Synthesis Results dialog box that appears, click **OK** to launch synthesis first. Synthesis runs, and implementation starts automatically when synthesis completes.

Note: The dialog box appears because you are running implementation without first running synthesis.

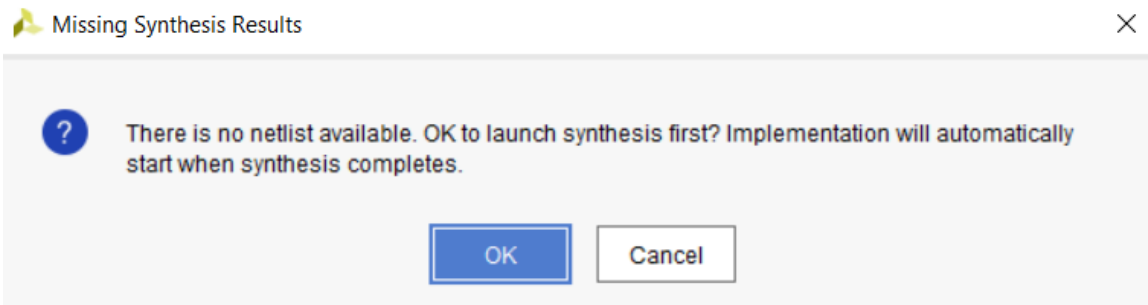

3. After implementation finishes, the Implementation Complete dialog box opens. Click **Cancel** to dismiss the dialog box.

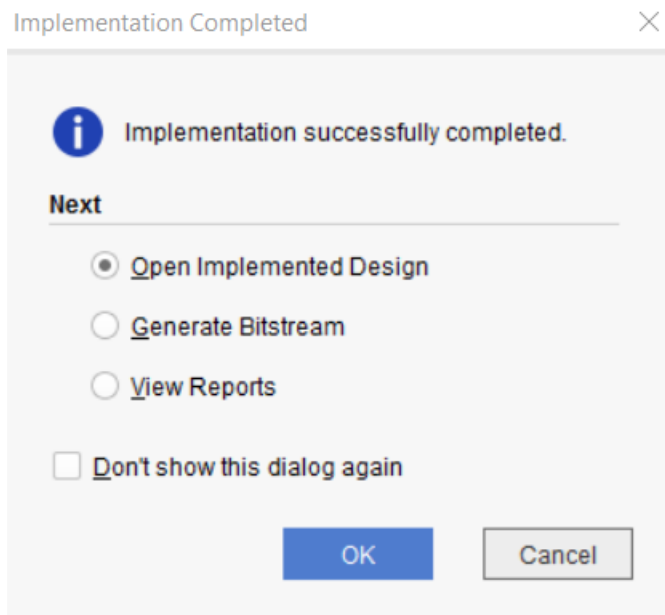

In a project-based design, the Vivado Design Suite saves intermediate implementation results as design checkpoints in the implementation runs directory. You will use the final checkpoint as the reference to the incremental compile flow.

Step 5: Making Incremental Changes

In this step, you make minor changes to the RTL design sources. These changes necessitate resynthesizing the netlist and re-implementing the design.

1. In the Hierarchy tab of the Sources window, double-click the top-level VHDL file, `core_transform.vhdl` under `arnd1`, to open the file in the Vivado IDE text editor, as shown in the following figure.

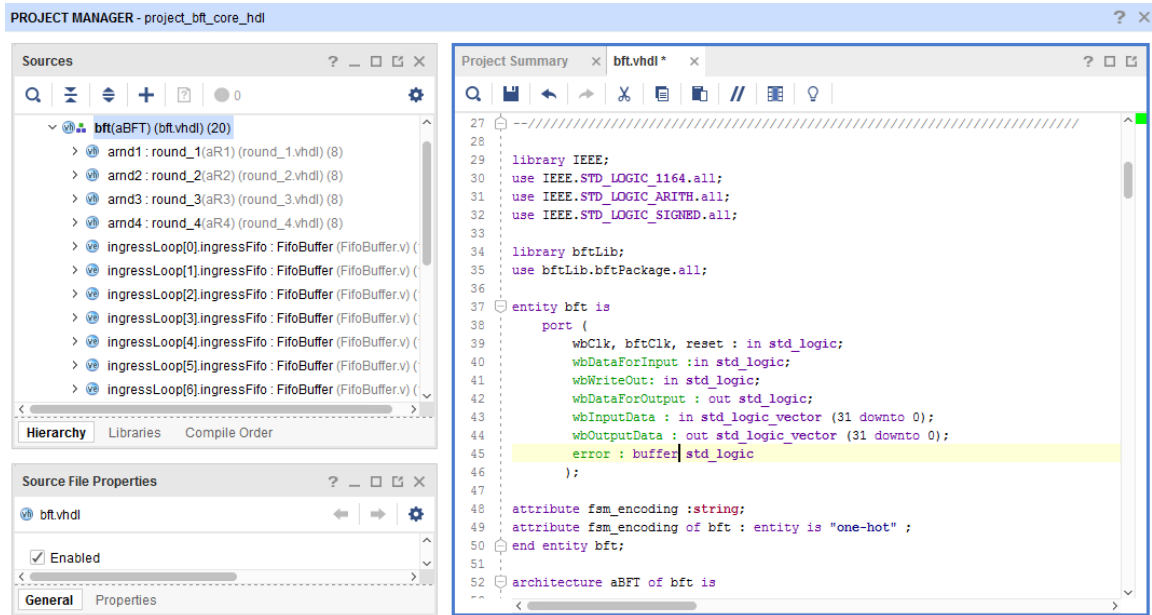

- Go to line 65 and make swap the inputs to `uReg` and `xReg`. The following code snippet shows the required changes:

From	To
<pre>begin process (clk) begin if rising_edge(clk) then xStepReg <= xStep; uReg <= u; xReg <= x; end if; end process;</pre>	<pre>begin process (clk) begin if rising_edge(clk) then xStepReg <= xStep; --uReg <= u; --xReg <= x; uReg <= x; xReg <= u; end if; end process;</pre>

- Save the changes by clicking the Save File button in the toolbar of the text editor.

As you can see in the following figure, changing the design source files also changes the run status for finished runs from Complete to Out-of-date.

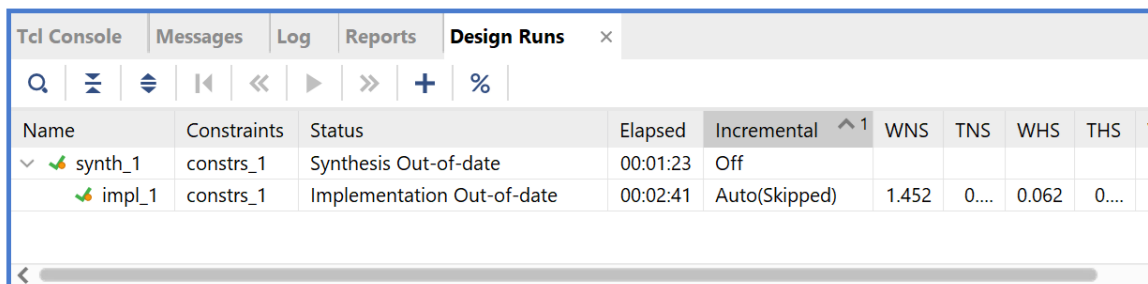

Step 6: Rerunning Synthesis and Implementation

With changes to the RTL source now made, synthesis and implementation must be rerun. As Incremental Implementation has already been configured, all that must be done is to relaunch the tool flow as would be done in the default flow.

1. In the Flow Navigator, click on **Run Implementation**. At this point, all the runs are reset and relaunched.

In the Sources window, the Utility Sources is updated with the checkpoint from the previously routed `impl_1` if the checkpoint has met certain criteria to ensure it is a good quality reference checkpoint for future runs.

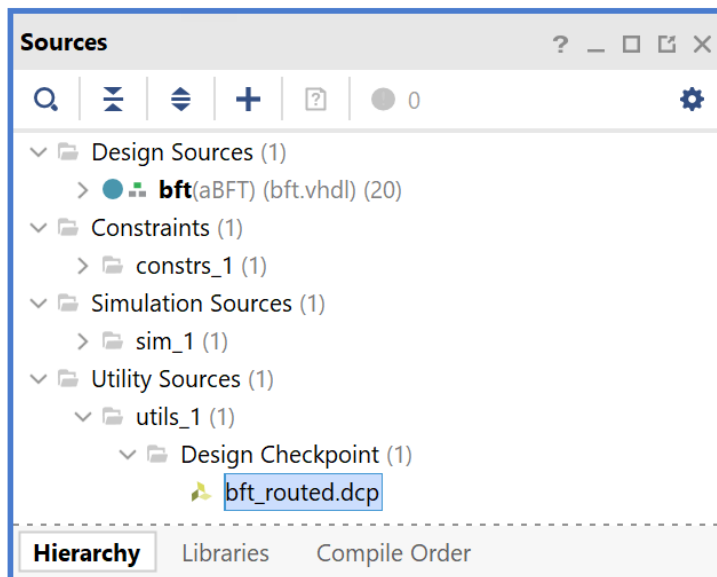

Also updated is the Incremental column in the Design Runs window. This should now say Auto. If the checkpoint did not meet the criteria to be used as a suitable reference, it shows Auto(Skipped) as before.

After implementation is complete, the Design Runs window shows the completed run.

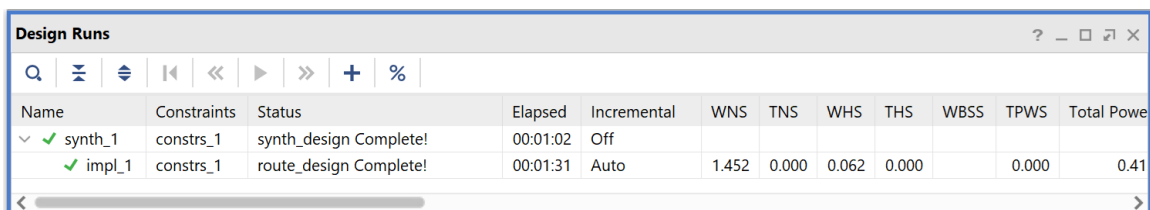

Name	Constraints	Status	Elapsed	Incremental	WNS	TNS	WHS	THS	WBSS	TPWS	Total Power
synth_1	constrs_1	synth_design Complete!	00:01:02	Off							
impl_1	constrs_1	route_design Complete!	00:01:31	Auto	1.452	0.000	0.062	0.000		0.000	0.41

In the Design Runs window, it is possible to examine runtime and timing criteria. In this case:

- Runtime has reduced for implementation as seen in the Elapsed column.

- WNS > 0.000 has been maintained

Note: Synthesis has not been run in a different mode than before so should be similar to before.

The “Elapsed” column measurement includes improvements to the `place_design` (`phys_opt_design` is not run here) and `route_design` and also the extra commands that are required in the incremental flow such as `read_checkpoint -incremental` and the extra reporting. To see more significant runtime improvements, the flow should be used on larger designs with a good reference checkpoint.

Note: `opt_design` is not incremental and runtime for `opt_design` is unimpacted.

Designs that have a complex flow, requiring most effort in the reference run see the highest benefit. Ideally, reference checkpoints are timing-closed, with fewer than 5% of the leaf cells different than the updated design.

2. Select the **Reports** window and double-click the Incremental Reuse Report in the Route Design section, as shown in the following figure.

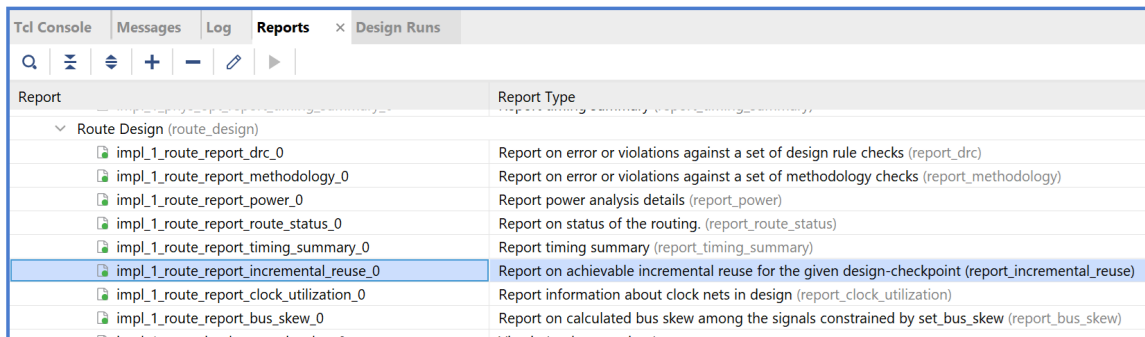

Report	Report Type
Route Design (route_design)	
impl_1_route_report_drc_0	Report on error or violations against a set of design rule checks (report_drc)
impl_1_route_report_methodology_0	Report on error or violations against a set of methodology checks (report_methodology)
impl_1_route_report_power_0	Report power analysis details (report_power)
impl_1_route_report_route_status_0	Report on status of the routing. (report_route_status)
impl_1_route_report_timing_summary_0	Report timing summary (report_timing_summary)
impl_1_route_report_incremental_reuse_0	Report on achievable incremental reuse for the given design-checkpoint (report_incremental_reuse)
impl_1_route_report_clock_utilization_0	Report information about clock nets in design (report_clock_utilization)
impl_1_route_report_bus_skew_0	Report on calculated bus skew among the signals constrained by set_bus_skew (report_bus_skew)

So far, you have modified the generation of the `readEgressFifo` so that the signal is zero when the error signal is non-zero. This is a small change to the design so you would expect the reuse to be high. Now examine the Incremental Reuse Report to confirm this is the case.

Incremental Implementation Information

Table of Contents

- 1. Reuse Summary
- 2. Reference Checkpoint Information
- 3. Comparison with Reference Run
- 4. Non Reuse Information

1. Reuse Summary

Type	Matched % (of Total)	Reuse % (of Total)	Fixed % (of Total)	Total
Cells	99.07	99.52	1.98	3578
Nets	99.71	98.97	0.00	5189
Pins	-	89.30	-	19495
Ports	100.00	100.00	100.00	71

* Reused % can exceed matched % when unmatched cells take their placement directly from other cells that have been matched

2. Reference Checkpoint Information

DCP Location: C:/Vivado_Tutorial/project_bft_core/project_bft_core.srcs/utils_1/imports/impl_1/bft_routed.dcp

DCP Information	Value
Vivado Version	2019.1
DCP State	POST_ROUTE
Recorded WNS	1.450
Recorded WHS	0.059
Reference Speed File Version	PRODUCTION 1.12 2017-02-17
Incremental Speed File Version	PRODUCTION 1.12 2017-02-17

* Recorded WNS/WHS timing numbers are estimated timing numbers. They may vary slightly from sign-off timing numbers.

In the report you can confirm that a high percentage of cells, nets and ports are fully reused.

In the Reference Checkpoint Information section you can see information reported on the reference checkpoint. This is useful when the source of the checkpoint is unknown.

3. Comparison with Reference Run

Stage	WNS (ns)		Runtime (elapsed) (hh:mm)		Runtime (cpu) (hh:mm)	
	Reference	Incremental	Reference	Incremental	Reference	Incremental
synth_design			< 1 min	00:01	< 1 min	00:01
opt_design			00:01	00:01	00:01	00:01
read_checkpoint			< 1 min	< 1 min		< 1 min
place_design	2.209	1.795	< 1 min	< 1 min	00:01	< 1 min
route_design	1.794	1.793	00:01	00:01	00:01	00:01

4. Non Reuse Information

Type	%
Non-Reused Cells	0.62
New	0.62
Partially reused nets	0.00
Non-Reused nets	0.54
Non-Reused Ports	0.00

In the Comparison with Reference Run section, you can see how the runtime and WNS at each stage of the flow compares. This is good for debugging purposes to understand where WNS and runtime diverge when there are issues. Note that these designs are not 100% the same so this information is a only guide.

When run with the RuntimeOptimized directive, the target WNS of this run is either 0.0 or the WNS from the reference run if it is < 0.0. To always target a timing closed design (Target WNS = 0.0 ns), the incremental directive must be set TimingClosure. This can be done by applying the following command:

```
set_property -name INCREMENTAL_CHECKPOINT.MORE_OPTIONS -value {-
incremental_directive TimingClosure} -objects [get_runs impl_1]
```

Conclusion

This concludes Lab 2. You can close the current project and exit the Vivado IDE.

In this lab, you learned how to run the Incremental Implementation portion of the Incremental Compile flow, using a checkpoint from a previously implemented design. You also examined the similarity between a reference design checkpoint and the current design by examining the Incremental Reuse Report.

Manual and Directed Routing

In this lab, you learn how to use the Vivado[®] IDE to assign routing to nets for precisely controlling the timing of a critical portion of the design.

- You will use the BFT HDL example design that is included in the Vivado[®] Design Suite.
- To illustrate the manual routing feature, you will precisely control the skew within the output bus of the design, `wbOutputData`.

Step 1: Opening the Example Project

1. Start by loading Vivado IDE by doing one of the following:
 - Launch the Vivado IDE from the icon on the Windows desktop.
 - Type `vivado` from a command terminal.
2. From the Getting Started page, click **Open Example Project**.

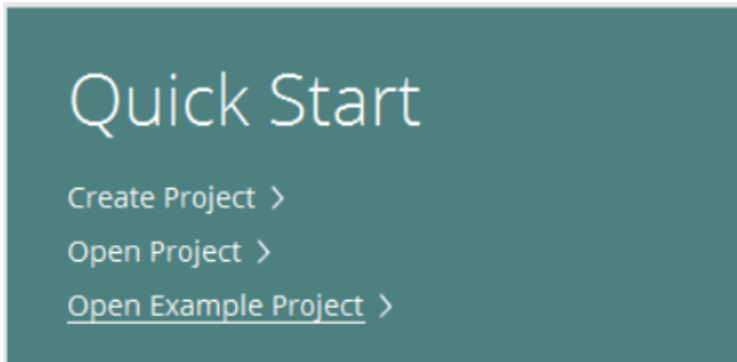

3. In the Create an Example Project page, click **Next**.

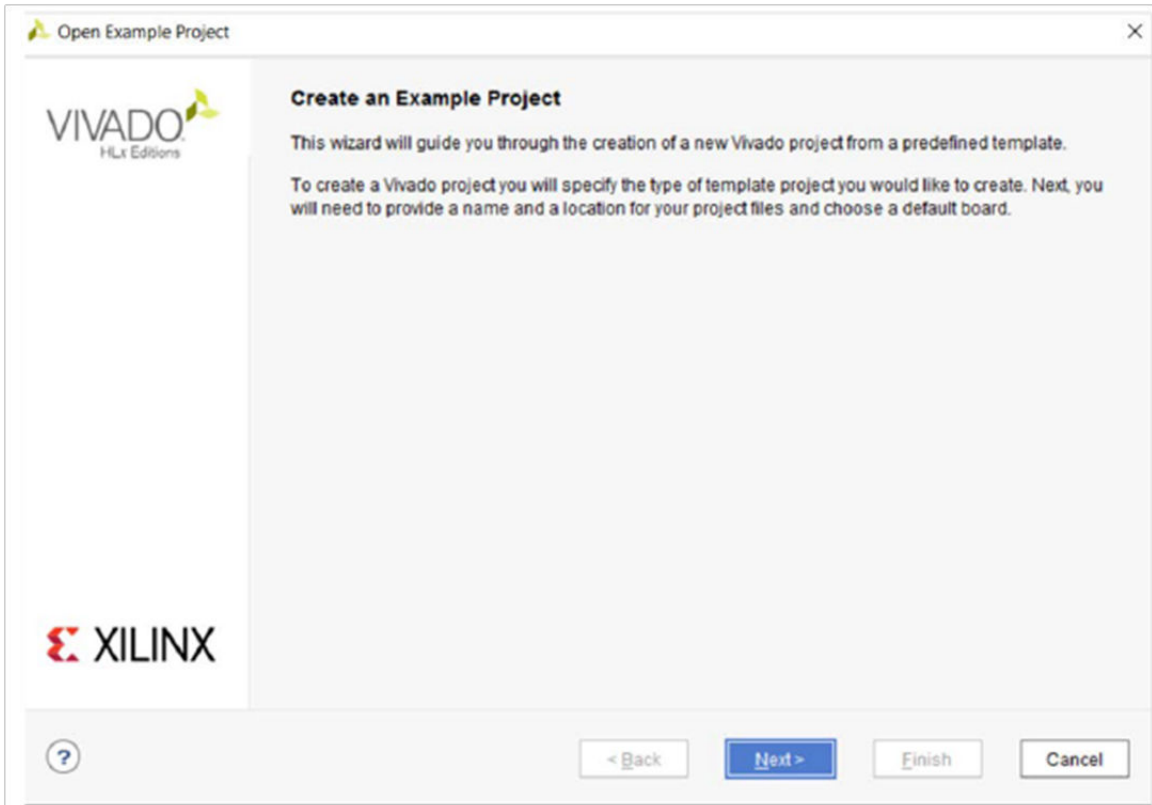

4. In the Select Project Template page, select the **BFT (Small RTL project)** design, and click **Next**.

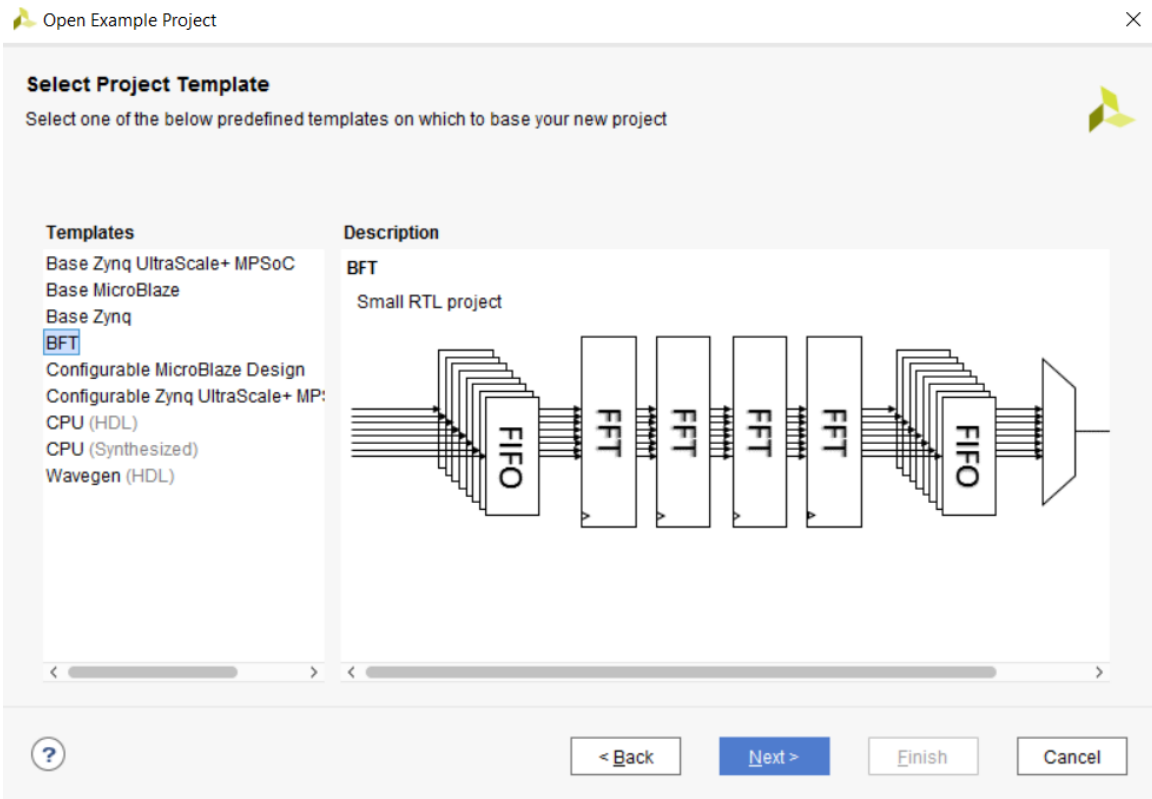

5. In the Project Name page, specify the following, and click **Next**:

- Project name: `project_bft_core`
- Project location: `<Project_Dir>`

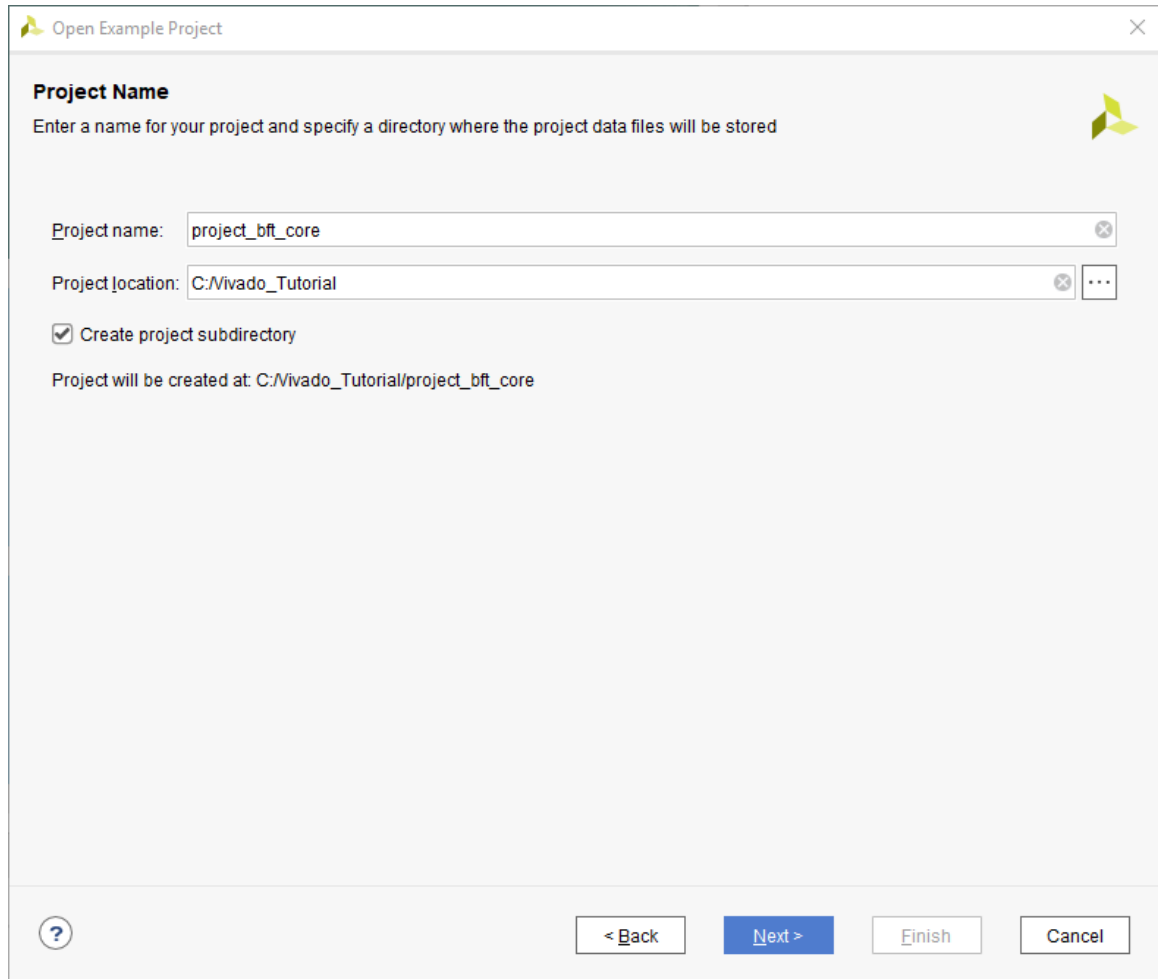

6. In the Default Part page, select the **xc7k70tfbg484-2** as your Default Part, and click **Next**.

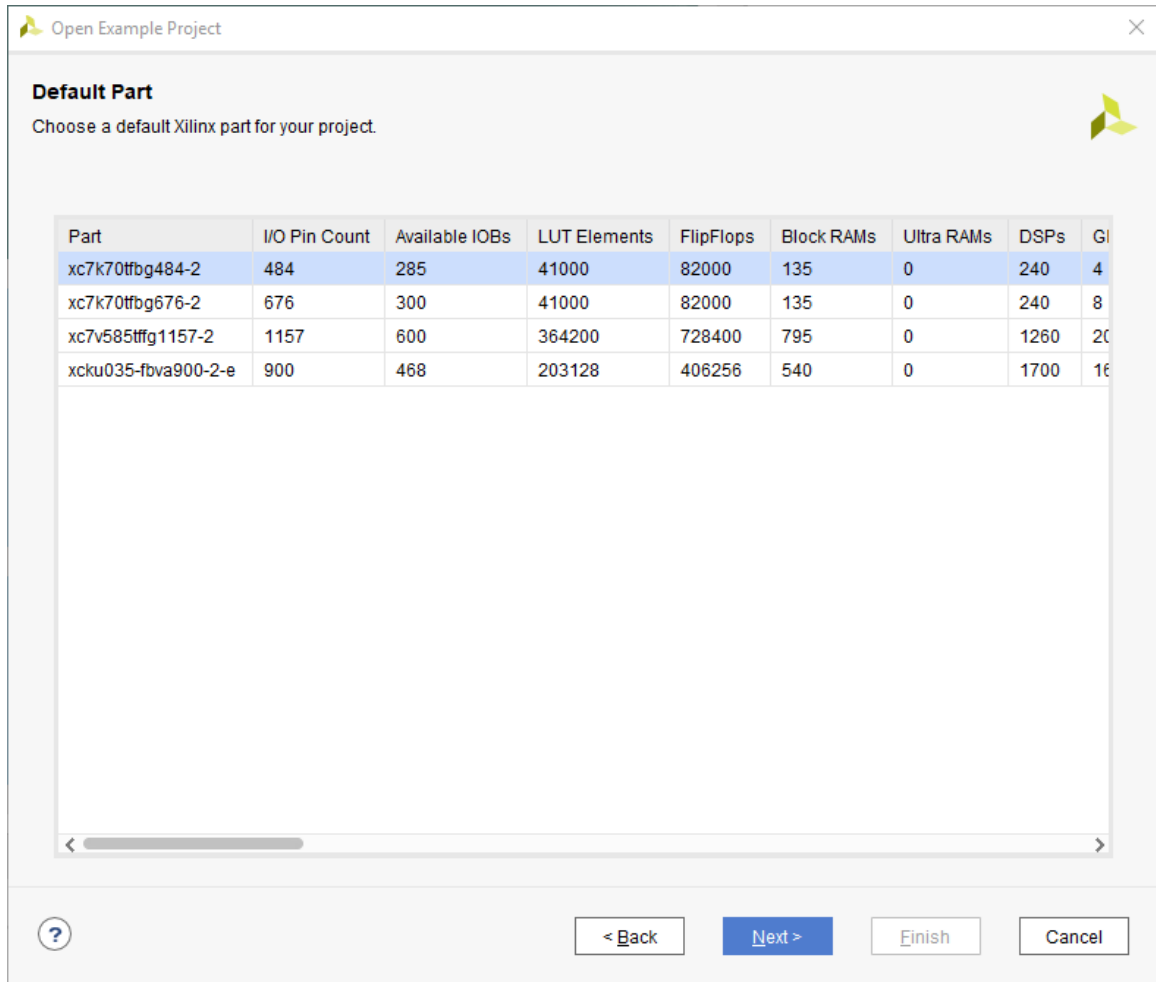

7. In the New Project Summary page, review the project details, and click **Finish**.

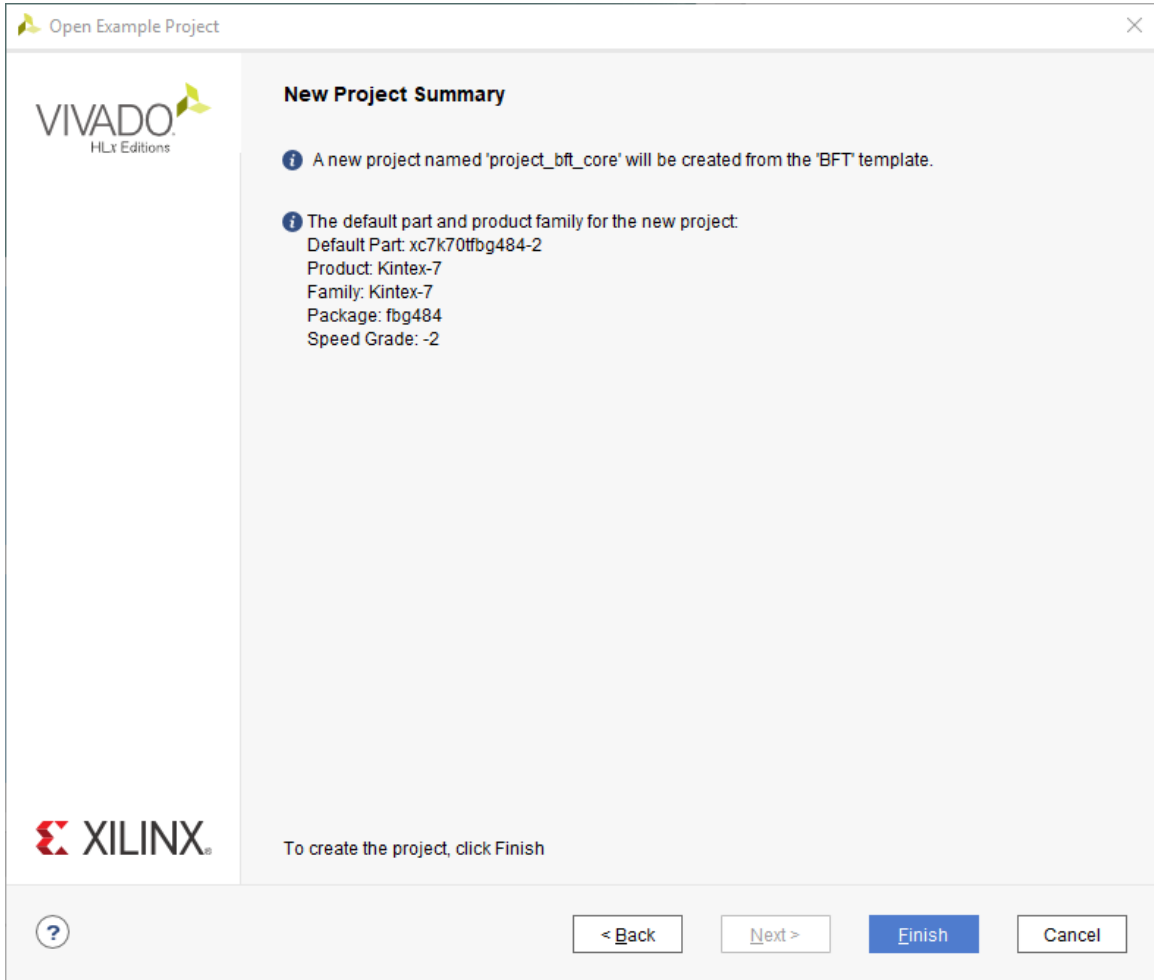

The Vivado IDE opens with the default view.

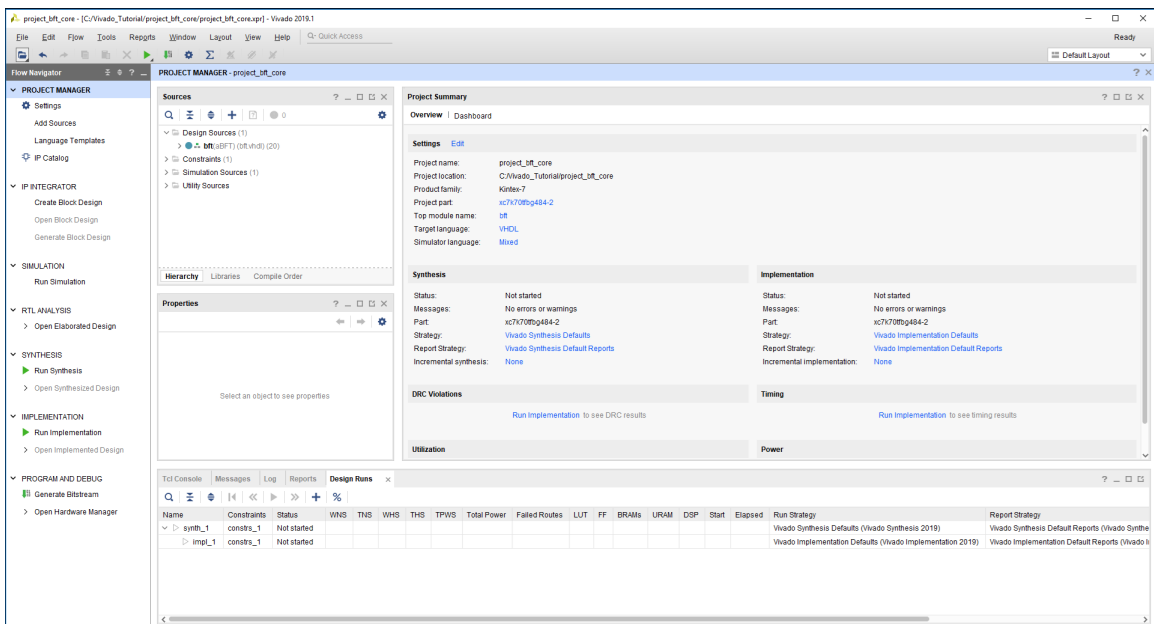

Step 2: Performing Place and Route on the Design

1. In the Flow Navigator, click **Run Implementation**.

The Missing Synthesis Results dialog box opens to inform you that there is no synthesized netlist to implement, and prompts you to start synthesis first.

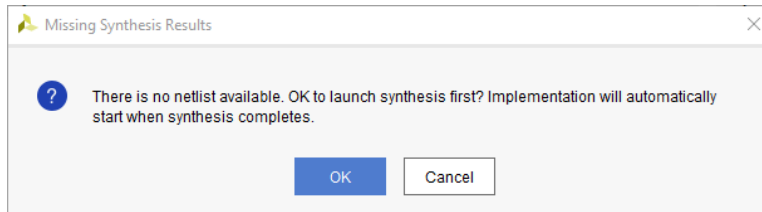

2. Click **OK** to launch synthesis first.

Implementation automatically starts after synthesis completes, and the Implementation Completed dialog box opens when complete, as shown in the following figure.

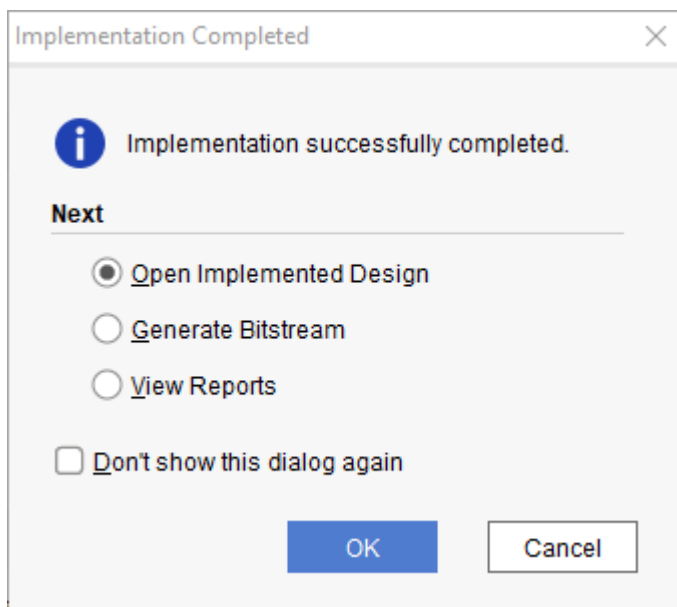

3. In the Implementation Completed dialog box, select **Open Implemented Design** and click **OK**.

The Device window opens, displaying the placement results.

4. Click the Routing Resources button  to view the detailed routing resources in the Device window.

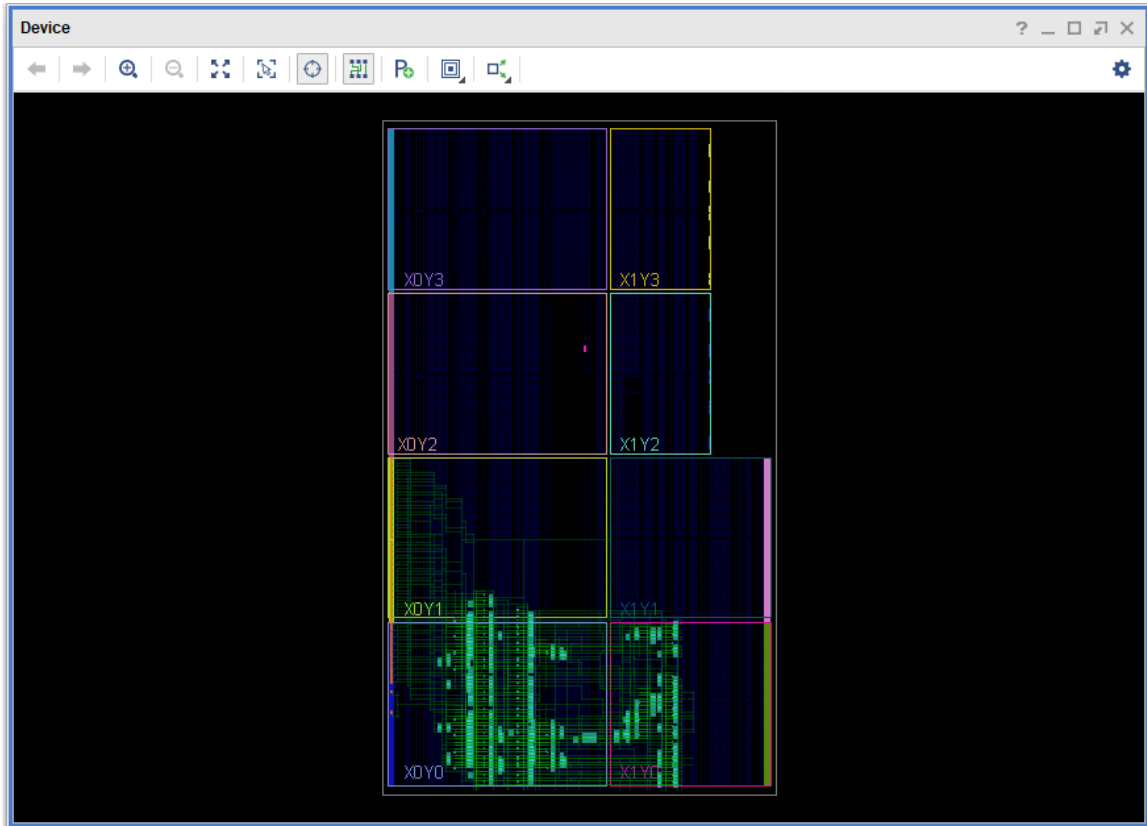

Step 3: Analyzing Output Bus Timing

★ **IMPORTANT!** The tutorial design has an output data bus, `wbOutputData`, which feeds external logic. Your objective is to precisely control timing skew by manually routing the nets of this bus.

You can use the Report Datasheet command to analyze the current timing of members of the output bus, `wbOutputData`. The Report Datasheet command lets you analyze the timing of a group of ports with respect to a specific reference port.

1. From the main menu, select **Reports** → **Timing** → **Report Datasheet**.
2. Select the **Groups** tab in the Report Datasheet dialog box, as seen in the following figure, and enter the following:
 - Reference: `[get_ports {wbOutputData[0]}]`
 - Ports: `[get_ports {wbOutputData[*]}]`

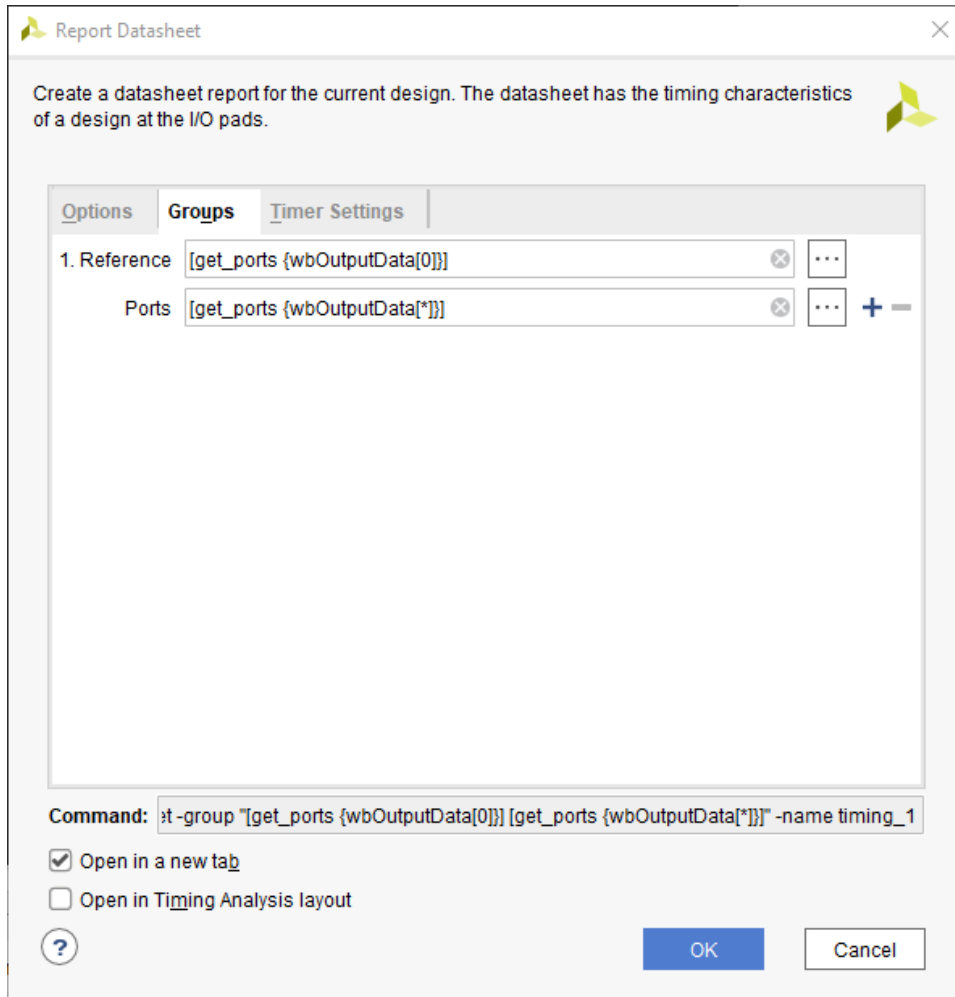

3. Click **OK**.

In this case, you are examining the timing at the ports carrying the `wbOutputData` bus, relative to the first bit of the bus, `wbOutputData[0]`. This allows you to quickly determine the relative timing differences between the different bits of the bus.

4. Click the Maximize button to maximize the Timing - Datasheet window and expand the results.
5. Select the **Max/Min Delays for Groups** → **Clocked by wbClk** → **wbOutputData[0]** section, as seen in the following figure.

You can see from the report that the timing skew across the `wbOutputData` bus varies by almost 660 ps. The goal is to minimize the skew across the bus to less than 100 ps.

Timing

Max/Min Delays for Groups - Clocked by wbClk - wbOutputData[0]

Pad	Max Delay	Max Edge	Max Process Corner	Min Delay	Min Edge	Min Process Corner	E
wbOutputData[28]	9.281	Rise	SLOW	4.060	Rise	FAST	0.659
wbOutputData[31]	9.249	Rise	SLOW	4.054	Rise	FAST	0.627
wbOutputData[30]	9.226	Rise	SLOW	4.029	Rise	FAST	0.604
wbOutputData[27]	9.214	Rise	SLOW	4.023	Rise	FAST	0.592
wbOutputData[26]	9.202	Rise	SLOW	3.997	Rise	FAST	0.580
wbOutputData[24]	9.190	Rise	SLOW	3.998	Rise	FAST	0.568
wbOutputData[29]	9.130	Rise	SLOW	3.971	Rise	FAST	0.508
wbOutputData[23]	9.079	Rise	SLOW	3.949	Rise	FAST	0.457
wbOutputData[20]	9.011	Rise	SLOW	3.929	Rise	FAST	0.389
wbOutputData[25]	8.984	Rise	SLOW	3.897	Rise	FAST	0.362
wbOutputData[21]	8.962	Rise	SLOW	3.874	Rise	FAST	0.340
wbOutputData[22]	8.945	Rise	SLOW	3.870	Rise	FAST	0.323
wbOutputData[12]	8.828	Rise	SLOW	3.821	Rise	FAST	0.206
wbOutputData[18]	8.813	Rise	SLOW	3.784	Rise	FAST	0.191
wbOutputData[6]	8.801	Rise	SLOW	3.822	Rise	FAST	0.179
wbOutputData[9]	8.784	Rise	SLOW	3.801	Rise	FAST	0.162
wbOutputData[13]	8.771	Rise	SLOW	3.808	Rise	FAST	0.149
wbOutputData[19]	8.760	Rise	SLOW	3.773	Rise	FAST	0.138
wbOutputData[14]	8.747	Rise	SLOW	3.774	Rise	FAST	0.125
wbOutputData[11]	8.738	Rise	SLOW	3.782	Rise	FAST	0.116
wbOutputData[15]	8.722	Rise	SLOW	3.758	Rise	FAST	0.100
wbOutputData[1]	8.522	Rise	SLOW	3.645	Rise	FAST	0.100
wbOutputData[8]	8.717	Rise	SLOW	3.753	Rise	FAST	0.095
wbOutputData[16]	8.714	Rise	SLOW	3.753	Rise	FAST	0.092
wbOutputData[3]	8.534	Rise	SLOW	3.646	Rise	FAST	0.088
wbOutputData[10]	8.541	Rise	SLOW	3.667	Rise	FAST	0.081
wbOutputData[17]	8.687	Rise	SLOW	3.708	Rise	FAST	0.065
wbOutputData[7]	8.675	Rise	SLOW	3.736	Rise	FAST	0.053
wbOutputData[2]	8.674	Rise	SLOW	3.735	Rise	FAST	0.052
wbOutputData[4]	8.649	Rise	SLOW	3.709	Rise	FAST	0.028
wbOutputData[5]	8.642	Rise	SLOW	3.736	Rise	FAST	0.021
wbOutputData[0]	8.622	Rise	SLOW	3.716	Rise	FAST	0.000
Worst Case Summary	9.281	Rise	SLOW	3.645	Rise	FAST	0.659

Bus Skew: 0.659 ns

Timing Summary - impl_1 (saved) x Datasheet - timing_1 x

6. Click the Restore button so you can simultaneously see the Device window and the Timing - Datasheet results.

7. Click the hyperlink for the Max Delay of the source `wbOutputData[28]`.

This highlights the path in the Device window that is currently open.

Note: Ensure the Autofit Selection is highlighted in the Device window so you can see the entire path, as shown in the following figure.

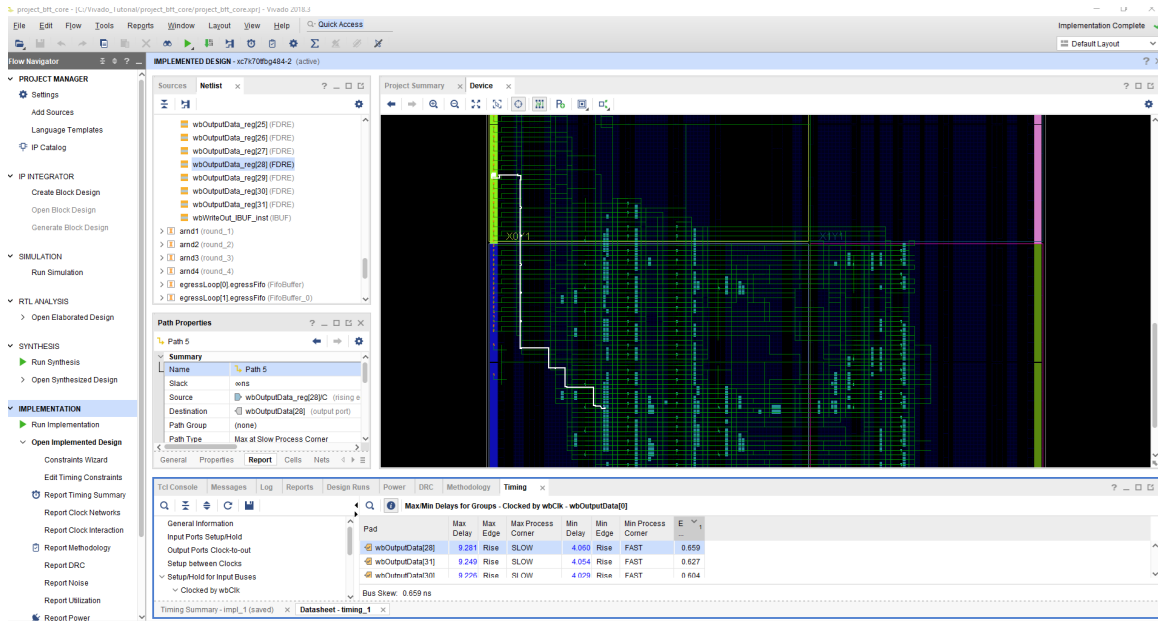

- In the Device window, right-click on the highlighted path and select Schematic from the popup menu.

This displays the schematic for the selected output data bus. From the schematic, you can see that the output port is directly driven from a register through an output buffer (OBUF).

If you can consistently control the placement of the register with respect to the output pins on the bus and control the routing between registers and the outputs, you can minimize skew between the members of the output bus.

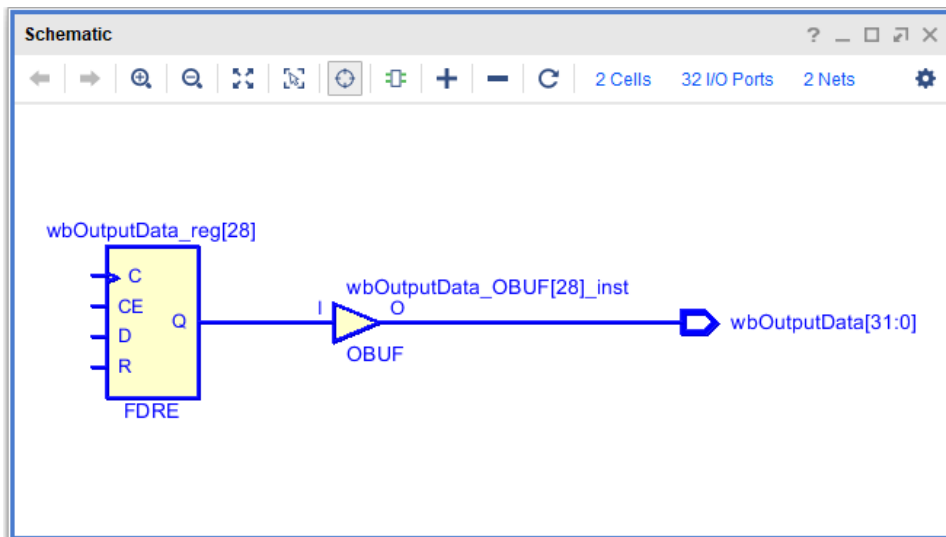

- Change to the Device window.

To better visualize the placement of the registers and outputs, you can use the `mark_objects` command to mark them in the Device window.

10. From the Tcl Console, type the following commands:

```
mark_objects -color blue [get_ports wbOutputData[*]]
mark_objects -color red [get_cells wbOutputData_reg[*]]
```

Blue diamond markers show on the output ports, and red diamond markers show on the registers feeding the outputs, as seen in the following figure.

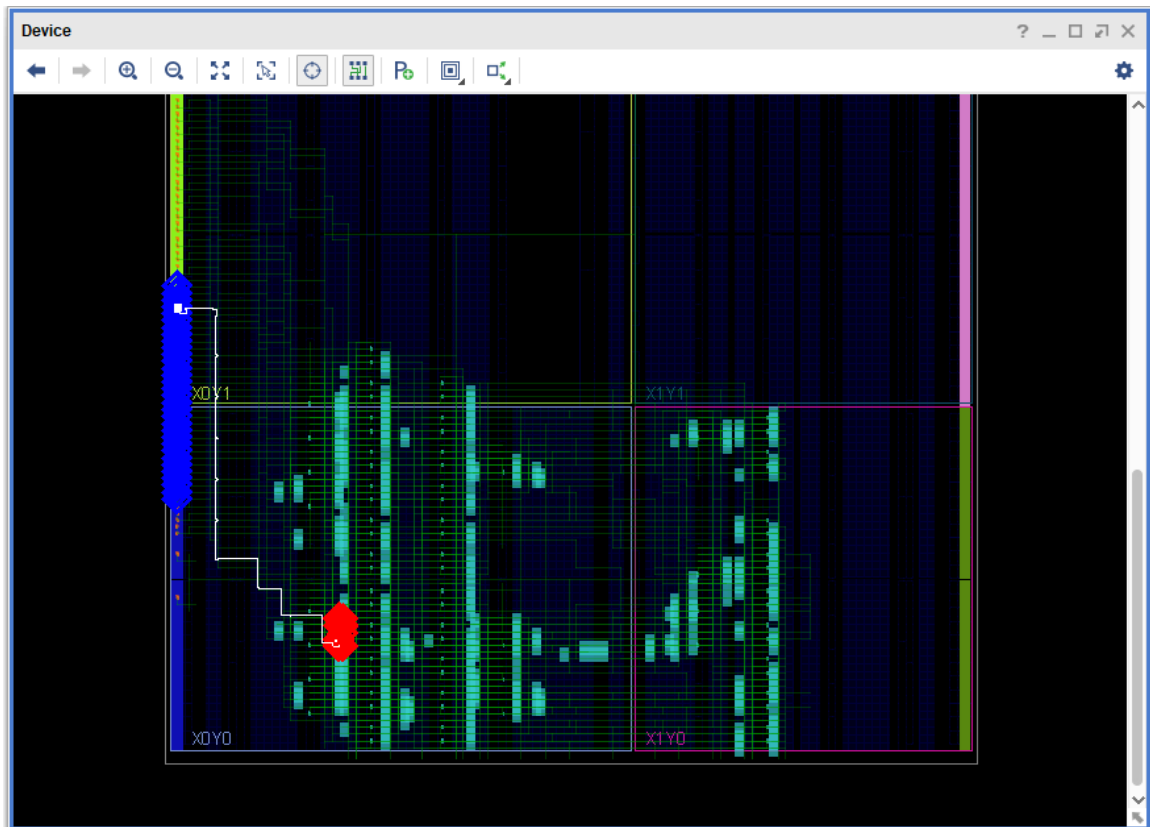

The outputs marked in blue are spread out along two banks on the left side starting with `wbOutputData[0]` (on the bottom) and ending with `wbOutputData[31]` (at the top), while the output registers marked in red are clustered close together on the right.

To look at all of the routing from the registers to the outputs, you can use the `highlight_objects` Tcl command to highlight the nets.



11. Type the following command at the Tcl prompt:

```
highlight_objects -color yellow [get_nets -of [get_pins -of [get_cells \
wbOutputData_reg[*]] -filter DIRECTION==OUT]]
```

This highlights all the nets connected to the output pins of the `wbOutputData_reg[*]` registers.

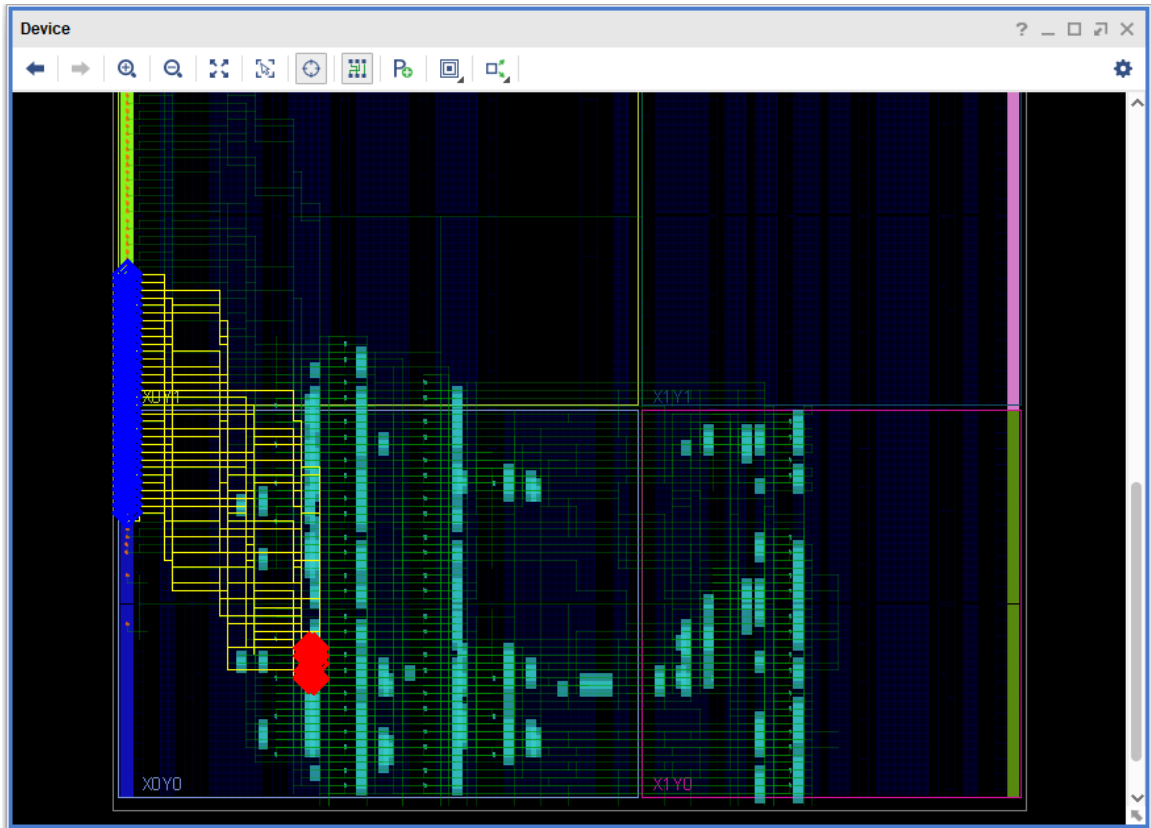
In the Device window, you can see that there are various routing distances between the clustered output registers and the distributed outputs pads of the bus. Consistently placing the output registers in the slices next to each output port eliminates a majority of the variability in the clock-to-out delay of the `wbOutputData` bus.





12. In the main toolbar, click the Unhighlight All  button and the Unmark All  button.

Step 4: Improving Bus Timing through Placement

To improve the timing of the `wbOutputData` bus you will place the output registers closer to their respective output pads, then rerun timing to look for any improvement. To place the output registers, you will identify potential placement sites, and then use a sequence of Tcl commands, or a Tcl script, to place the cells and reroute the connections.



RECOMMENDED: Use a series of Tcl commands to place the output registers in the slices next to the `wbOutputData` bus output pads.

1. In the Device window click to disable Routing Resources  and make sure Autofit Selection  is still enabled on the toolbar.

This lets you see placed objects more clearly in the Device window, without the added details of the routing.

2. Select the `wbOutputData` ports placed on the I/O blocks with the following Tcl command:

```
select_objects [get_ports wbOutputData*]
```

The Device window will show the selected ports highlighted in white, and zoom to fit the selection. By examining the device resources around the selected ports, you can identify a range of placement sites for the output registers.

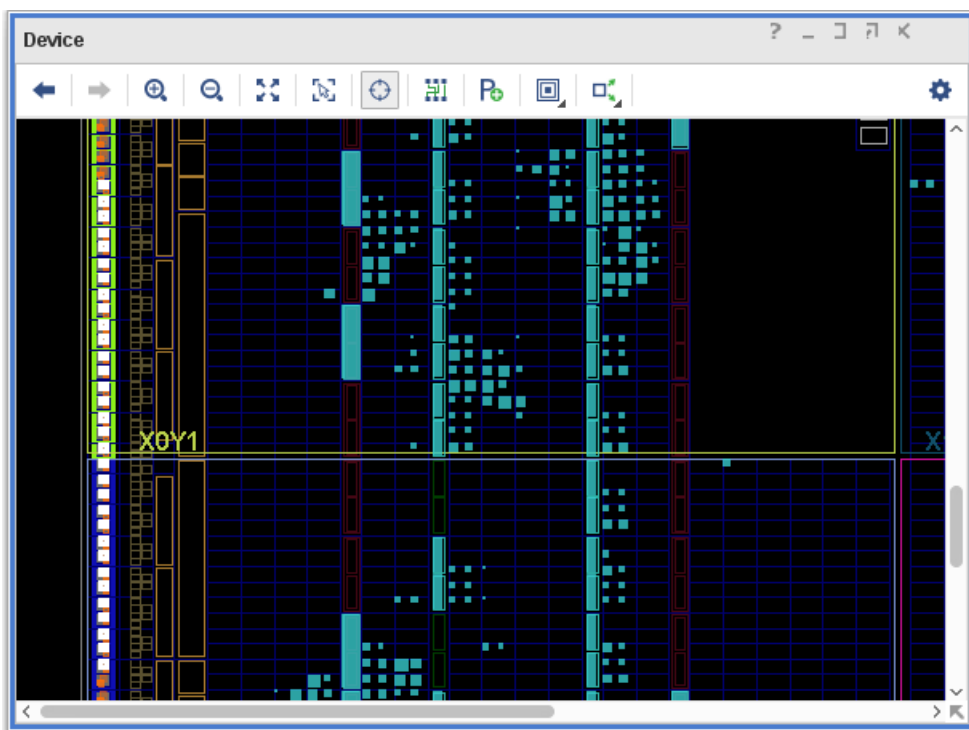

3. Zoom into the Device window around the bottom selected output ports. The following figure shows the results.

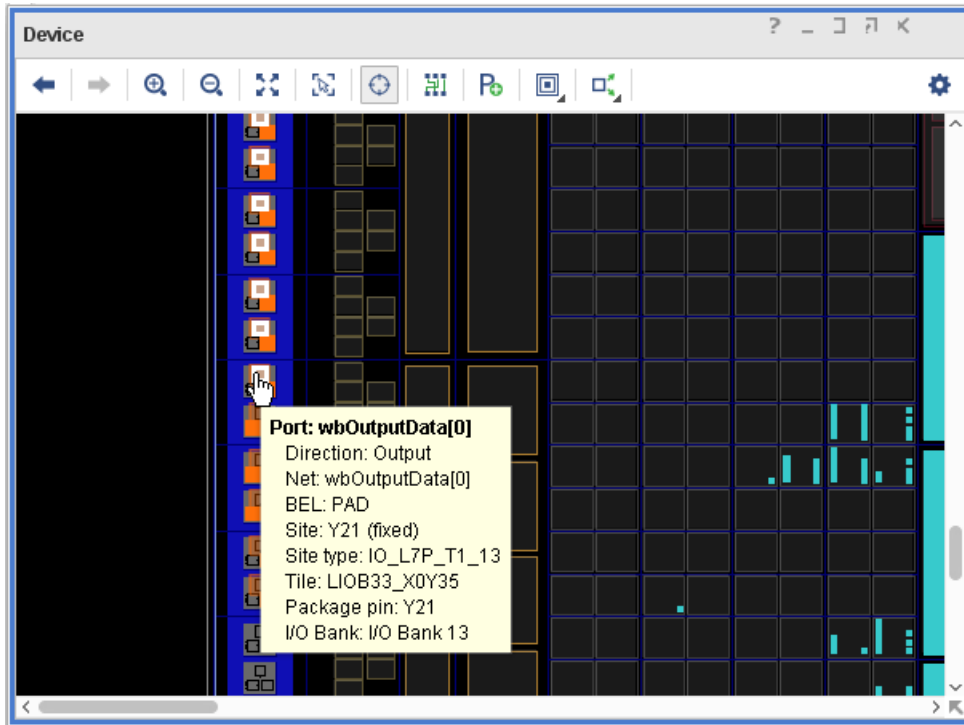

The bottom ports are the lowest bits of the output bus, starting with `wbOutputData[0]`.

This port is placed on Package Pin Y21. Over to the right, where the Slice logic contains the device resources needed to place the output registers, the Slice coordinates are X0Y36. You will use that location as the starting placement for the 32 output registers, `wbOutputData_reg[31:0]`.

By scrolling or panning in the Device window, you can visually confirm that the highest output data port, `wbOutputData[31]`, is placed on Package Pin K22, and the registers to the right are in Slice X0Y67.

Now that you have identified the placement resources needed for the output registers, you must make sure they are available for placing the cells. You will do this by quickly unplacing the Slices to clear any currently placed logic.

4. Unplace any cells currently assigned to the range of slices needed for the output registers, `SLICE_X0Y36` to `SLICE_X0Y67`, with the following Tcl command:

```
for {set i 0} {$i<32} {incr i} {
    unplace_cell [get_cells -of [get_sites SLICE_X0Y[expr 36 + $i]]]
}
```

This command uses a `for` loop with an index counter (`i`) and a Tcl expression (`36 + $i`) to get and unplace any cells found in the specified range of Slices. For more information on `for` loops and other scripting suggestions, refer to the *Vivado Design Suite User Guide: Using Tcl Scripting* (UG894).



TIP: If there are no cells placed within the specified slices, you will see warning messages that nothing has been unplaced. You can safely ignore these messages.

With the slices cleared of any current logic cells, the needed resources are available for placing the output registers. After placing those, you will also need to replace any logic that was unplaced in the last step.

- Place the output registers, `wbOutputData_reg[31:0]`, in the specified slice range with the following command:

```
for {set i 0} {$i<32} {incr i} {
    place_cell wbOutputData_reg[$i] SLICE_X0Y[expr 36 + $i]/AFF
}
```

- Place any remaining unplaced cells with the following command:

```
place_design
```

Note: The Vivado placer works incrementally on a partially placed design.

- As a precaution, unroute any nets connected to the output register cells, `wbOutputData_reg[31:0]`, using the following Tcl command:

```
route_design -unroute -nets [get_nets -of [get_cells \
wbOutputData_reg[*]]]
```

- Route any currently unrouted nets in the design:

```
route_design
```

Note: The Vivado router works incrementally on a partially routed design.

- Analyze the route status of the current design to ensure that there are no routing conflicts:

```
report_route_status
```

- Click the Routing Resources button  to view the detailed routing resources in the Device window.

- Mark the output ports and registers again, and re-highlight the routing between them using the following Tcl commands:

```
mark_objects -color blue [get_ports wbOutputData[*]]
mark_objects -color red [get_cells wbOutputData_reg[*]]
highlight_objects -color yellow [get_nets -of [get_pins -of [get_cells \
wbOutputData_reg[*]] -filter DIRECTION==OUT]]
```



TIP: Because you have entered these commands before, you can copy them from the journal file (`vivado.jou`) to avoid typing them again.

- In the Device window, zoom into some of the marked output ports.

- Select the nets connecting to them.



TIP: You can also select the nets in the Netlist window, and they will be cross-selected in the Device window.

In the Device window, you can see that all output registers are now placed equidistant from their associated outputs, and the routing path is very similar for all the nets from output register to output. This results in clock-to-out times that are closely matched between the outputs.

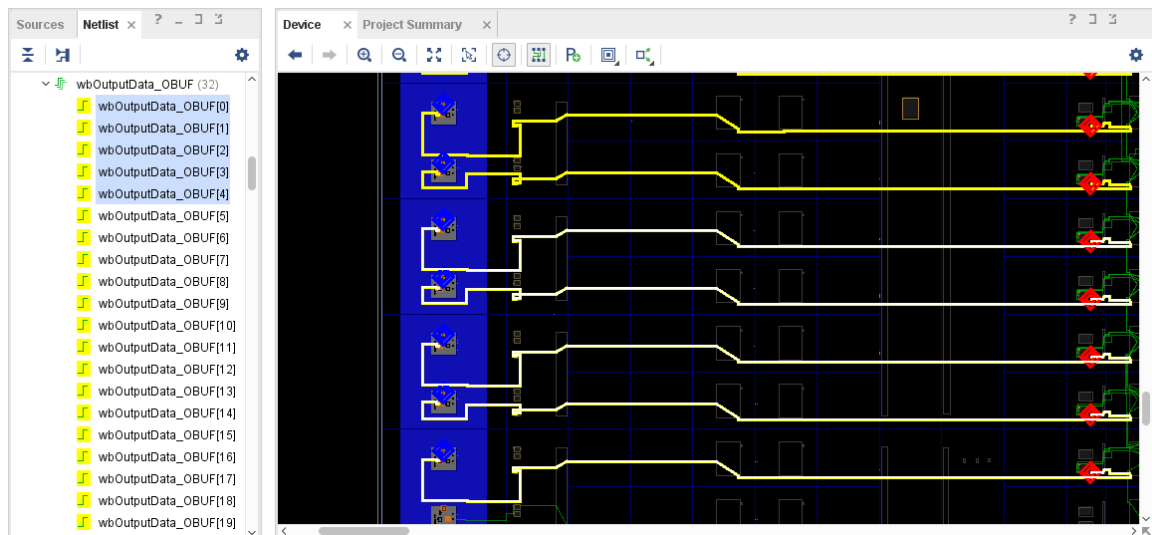

14. Run the **Reports → Timing → Report Datasheet** command again.

The Report Datasheet dialog box is populated with settings from the last time you ran it:

- Reference: [get_ports {wbOutputData[0]}]
- Ports: [get_ports {wbOutputData[*]}]

15. In the Report Datasheet results, select the **Max/Min Delays for Groups → Clocked by wbClk → wbOutputData[0]** section.

Examining the results, the timing skew is closely matched within both the lower bits, `wbOutputData[0-13]`, and the upper bits, `wbOutputData[14-31]`, of the output bus. While the overall skew is reduced, it is still over 200 ps between the upper and lower bits.

With the improved placement, the skew is now a result of the output ports and registers spanning two clock regions, X0Y0 and X0Y1, which introduces clock network skew. Looking at the `wbOutputData` bus, notice that the Max delay is greater on the lower bits than it is on the upper bits. To reduce the skew, add delay to the upper bits.

You can eliminate some of the skew using a BUFGMR/BUFR combination instead of a BUFG, to clock the output registers. However, for this tutorial, you will use manual routing to add delay from the output registers clocked by the BUFG to the output pins for the upper bits, `wbOutputData[14-31]`, to further reduce the clock-to-out variability within the bus.

Timing

Max/Min Delays for Groups - Clocked by wbClk - wbOutputData[0]

Pad	Max Delay	Max Edge	Max Process Corner	Min Delay	Min Edge	Min Process Corner	Edge Skew
wbOutputData[0]	7.911	Rise	SLOW	3.303	Rise	FAST	0.000
wbOutputData[31]	7.720	Rise	SLOW	3.236	Rise	FAST	0.190
wbOutputData[30]	7.697	Rise	SLOW	3.213	Rise	FAST	0.213
wbOutputData[29]	7.705	Rise	SLOW	3.221	Rise	FAST	0.205
wbOutputData[28]	7.707	Rise	SLOW	3.222	Rise	FAST	0.204
wbOutputData[27]	7.715	Rise	SLOW	3.228	Rise	FAST	0.196
wbOutputData[26]	7.688	Rise	SLOW	3.201	Rise	FAST	0.223
wbOutputData[25]	7.694	Rise	SLOW	3.208	Rise	FAST	0.217
wbOutputData[24]	7.695	Rise	SLOW	3.208	Rise	FAST	0.215
wbOutputData[23]	7.701	Rise	SLOW	3.214	Rise	FAST	0.210
wbOutputData[22]	7.687	Rise	SLOW	3.200	Rise	FAST	0.224
wbOutputData[21]	7.691	Rise	SLOW	3.203	Rise	FAST	0.220
wbOutputData[20]	7.723	Rise	SLOW	3.236	Rise	FAST	0.188
wbOutputData[19]	7.730	Rise	SLOW	3.242	Rise	FAST	0.181
wbOutputData[18]	7.678	Rise	SLOW	3.191	Rise	FAST	0.233
wbOutputData[17]	7.681	Rise	SLOW	3.193	Rise	FAST	0.230
wbOutputData[16]	7.718	Rise	SLOW	3.231	Rise	FAST	0.193
wbOutputData[15]	7.723	Rise	SLOW	3.236	Rise	FAST	0.188
wbOutputData[14]	7.755	Rise	SLOW	3.268	Rise	FAST	0.156
wbOutputData[13]	7.942	Rise	SLOW	3.336	Rise	FAST	0.032
wbOutputData[12]	7.891	Rise	SLOW	3.284	Rise	FAST	0.019
wbOutputData[11]	7.897	Rise	SLOW	3.290	Rise	FAST	0.014
wbOutputData[10]	7.905	Rise	SLOW	3.297	Rise	FAST	0.007
wbOutputData[9]	7.914	Rise	SLOW	3.306	Rise	FAST	0.004
wbOutputData[8]	7.886	Rise	SLOW	3.278	Rise	FAST	0.025
wbOutputData[7]	7.881	Rise	SLOW	3.274	Rise	FAST	0.030
wbOutputData[6]	7.915	Rise	SLOW	3.306	Rise	FAST	0.004
wbOutputData[5]	7.919	Rise	SLOW	3.311	Rise	FAST	0.008
wbOutputData[4]	7.868	Rise	SLOW	3.261	Rise	FAST	0.043
wbOutputData[3]	7.874	Rise	SLOW	3.267	Rise	FAST	0.037
wbOutputData[2]	7.875	Rise	SLOW	3.269	Rise	FAST	0.035
wbOutputData[1]	7.878	Rise	SLOW	3.271	Rise	FAST	0.033
wbOutputData[0]	7.911	Rise	SLOW	3.303	Rise	FAST	0.000
Worst Case Summary	7.942	Rise	SLOW	3.191	Rise	FAST	0.233

Bus Skew: 0.233 ns

Datasheet - timing_2

Step 5: Using Manual Routing to Reduce Clock Skew

To adjust the skew, begin by examining the current routing of the nets, `wbOutputData_OBUF[14:31]`, to see where changes might be made to consistently add delay. You can use a `Tcl for` loop to report the existing routing on those nets, to let you examine them more closely.

1. In the Tcl Console, type the following command:

```
for {set i 14} {$i<32} {incr i} {
    puts "$i [get_property ROUTE [get_nets -of [get_pins -of \
    [get_cells wbOutputData_reg[$i]] -filter DIRECTION==OUT]]]"
}
```

This `for` loop initializes the index to 14 (set `i 14`), and gets the `ROUTE` property to return the details of the route on each selected net.

The Tcl Console returns the net index followed by relative route information for each net:

```
14 { CLBLL_LL_AQ CLBLL_LOGIC_OUTS4 WW2BEG0 IMUX_L34 IOI_OLOGIC0_D1
LIOI_OLOGIC0_OQ LIOI_O0 }
15 { CLBLL_LL_AQ CLBLL_LOGIC_OUTS4 WW2BEG0 IMUX_L34 IOI_OLOGIC1_D1
LIOI_OLOGIC1_OQ LIOI_O1 }
16 { CLBLL_LL_AQ CLBLL_LOGIC_OUTS4 WW2BEG0 IMUX_L34 IOI_OLOGIC0_D1
LIOI_OLOGIC0_OQ LIOI_O0 }
17 { CLBLL_LL_AQ CLBLL_LOGIC_OUTS4 WW2BEG0 IMUX_L34 IOI_OLOGIC1_D1
LIOI_OLOGIC1_OQ LIOI_O1 }
18 { CLBLL_LL_AQ CLBLL_LOGIC_OUTS4 WW2BEG0 IMUX_L34 IOI_OLOGIC0_D1
LIOI_OLOGIC0_OQ LIOI_O0 }
19 { CLBLL_LL_AQ CLBLL_LOGIC_OUTS4 WW2BEG0 IMUX_L34 IOI_OLOGIC1_D1
LIOI_OLOGIC1_OQ LIOI_O1 }
20 { CLBLL_LL_AQ CLBLL_LOGIC_OUTS4 WW2BEG0 IMUX_L34 IOI_OLOGIC0_D1
LIOI_OLOGIC0_OQ LIOI_O0 }
21 { CLBLL_LL_AQ CLBLL_LOGIC_OUTS4 WW2BEG0 IMUX_L34 IOI_OLOGIC1_D1
LIOI_OLOGIC1_OQ LIOI_O1 }
22 { CLBLL_LL_AQ CLBLL_LOGIC_OUTS4 WW2BEG0 IMUX_L34 IOI_OLOGIC0_D1
LIOI_OLOGIC0_OQ LIOI_O0 }
23 { CLBLL_LL_AQ CLBLL_LOGIC_OUTS4 WW2BEG0 IMUX_L34 IOI_OLOGIC1_D1
LIOI_OLOGIC1_OQ LIOI_O1 }
24 { CLBLL_LL_AQ CLBLL_LOGIC_OUTS4 WW2BEG0 IMUX_L34 IOI_OLOGIC0_D1
LIOI_OLOGIC0_OQ LIOI_O0 }
25 { CLBLL_LL_AQ CLBLL_LOGIC_OUTS4 WW2BEG0 IMUX_L34 IOI_OLOGIC1_D1
LIOI_OLOGIC1_OQ LIOI_O1 }
26 { CLBLL_LL_AQ CLBLL_LOGIC_OUTS4 WW2BEG0 IMUX_L34 IOI_OLOGIC0_D1
LIOI_OLOGIC0_OQ LIOI_O0 }
27 { CLBLL_LL_AQ CLBLL_LOGIC_OUTS4 WW2BEG0 IMUX_L34 IOI_OLOGIC1_D1
LIOI_OLOGIC1_OQ LIOI_O1 }
28 { CLBLL_LL_AQ CLBLL_LOGIC_OUTS4 WW2BEG0 IMUX_L34 IOI_OLOGIC0_D1
LIOI_OLOGIC0_OQ LIOI_O0 }
29 { CLBLL_LL_AQ CLBLL_LOGIC_OUTS4 WW2BEG0 IMUX_L34 IOI_OLOGIC1_D1
LIOI_OLOGIC1_OQ LIOI_O1 }
30 { CLBLL_LL_AQ CLBLL_LOGIC_OUTS4 WW2BEG0 IMUX_L34 IOI_OLOGIC0_D1
LIOI_OLOGIC0_OQ LIOI_O0 }
31 { CLBLL_LL_AQ CLBLL_LOGIC_OUTS4 WW2BEG0 IMUX_L34 IOI_OLOGIC1_D1
LIOI_OLOGIC1_OQ LIOI_O1 }
```

From the returned `ROUTE` properties, note that the nets are routed from the output registers using identical resources, up to node `IMUX_L34`. Beyond that, the Vivado router uses different nodes for odd and even index nets to complete the connection to the die pad.

By reusing routing paths, you can manually route one net with an even index, like `wbOutputData_OBUF[14]`, and one net with an odd index, such as `wbOutputData_OBUF[15]`, and copy the routing to all other even and odd index nets in the group.

- In the Tcl Console, select the first net with the following command:

```
select_objects [get_nets -of [get_pins -of \
[get_cells wbOutputData_reg[14]] -filter DIRECTION==OUT]]
```

- In the Device window, right-click to open the popup menu and select **Unroute**.
- Click **Yes** in the Confirm Unroute dialog box.

The Device window displays the unrouted net as a fly-line between the register and the output pad.

- Click the Maximize button to maximize the Device window.
- Right-click the net and select **Enter Assign Routing Mode**.

The Target Load Cell Pin dialog box opens, as seen in the following Figure, to let you select a load pin to route to or from. In this case, only one load pin populates:

wbOutputData_OBUF[14]_inst.

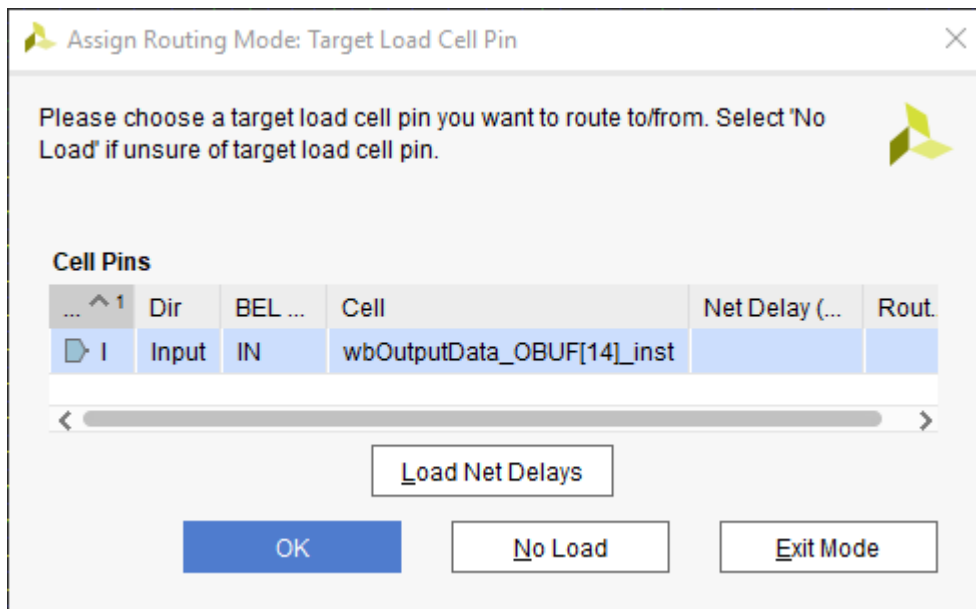

- Select the load cell pin **wbOutputData_OBUF[14]_inst/I**, and click **OK**.

The Vivado IDE enters into Assign Routing mode, displaying a new Routing Assignment window on the right side of the Device window, as shown in the following figure.

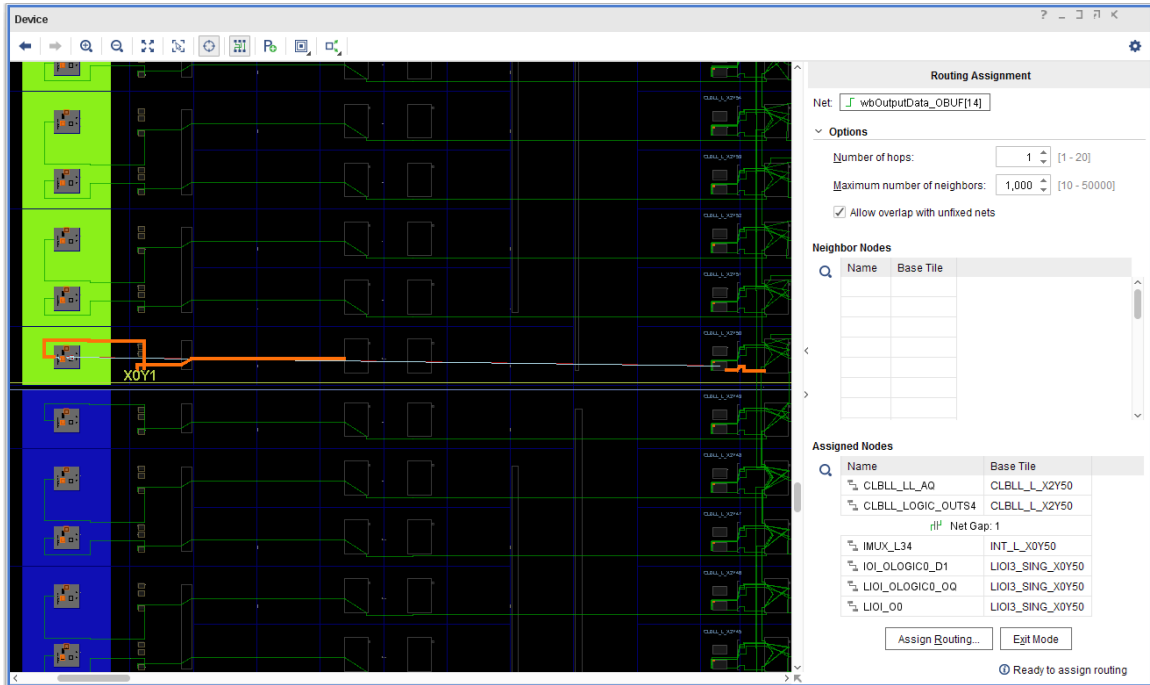

The Routing Assignment window includes the following sections:

- **Net:** Displays the current net being routed.
- **Options:** Are hidden by default, and can be displayed by clicking **Options**.
 - **Number of hops:** Defines how many programmable interconnect points, or PIPs, to look at when reporting the available neighbors. The default is 1.
 - **Maximum number of neighbors:** Limits the number of neighbors displayed for selection.
 - **Allow overlap with unfixed nets:** Enables or disables a loose style of routing which can create conflicts that must be later resolved. The default is ON.
- **Neighbor Nodes:** Lists the available neighbor PIPs/nodes to choose from when defining the path of the route.
- **Assigned Nodes:** Shows the currently assigned nodes in the route path of the selected net.
- **Assign Routing:** Assigns the currently defined path in the Routing Assignment window as the route path for the selected net.
- **Exit Mode:** Closes the Routing Assignment window.

The Assigned Nodes section displays six currently assigned nodes. The Vivado router automatically assigns a node if it is the only neighbor of a selected node and there are no alternatives to the assigned nodes for the route. In the Device window, the assigned nodes appear as a partial route in orange.

In the currently selected net, `wbOutputData_OBUF[14]`, nodes `CLBLL_LL_AQ` and `CLBLL_LOGIC_OUTS4` are already assigned because they are the only neighbor nodes available to the output register, `wbOutputData_reg[14]`. The nodes `IMUX_L34`, `IOI_OLOGIC0_D1`, `LIOI_OLOGIC0_OQ`, and `LIOI_O0` are also already assigned because they are the only neighbor nodes available to the destination, the output buffer (OBUF).

A gap exists between the two routed portions of the path where there are multiple neighbors to choose from when defining a route. This gap is where you will use manual routing to complete the path and add the needed delay to balance the clock skew.

You can route the gap by selecting a node on either side of the gap and then choosing the neighbor node to assign the route to. Selecting the node displays possible neighbor nodes in the Neighbor Nodes section of the Routing Assignment window and appear as dashed white lines in the Device window.



TIP: The number of reachable neighbor nodes displayed depends on the number of hops defined in the Options.

- Under the Assigned Nodes section, select the `CLBLL_LOGIC_OUTS4` node before the gap.

The available neighbors appear as shown in the following figure.

To add delay to compensate for the clock skew, select a neighbor node that provides a slight detour over the more direct route previously chosen by the router.

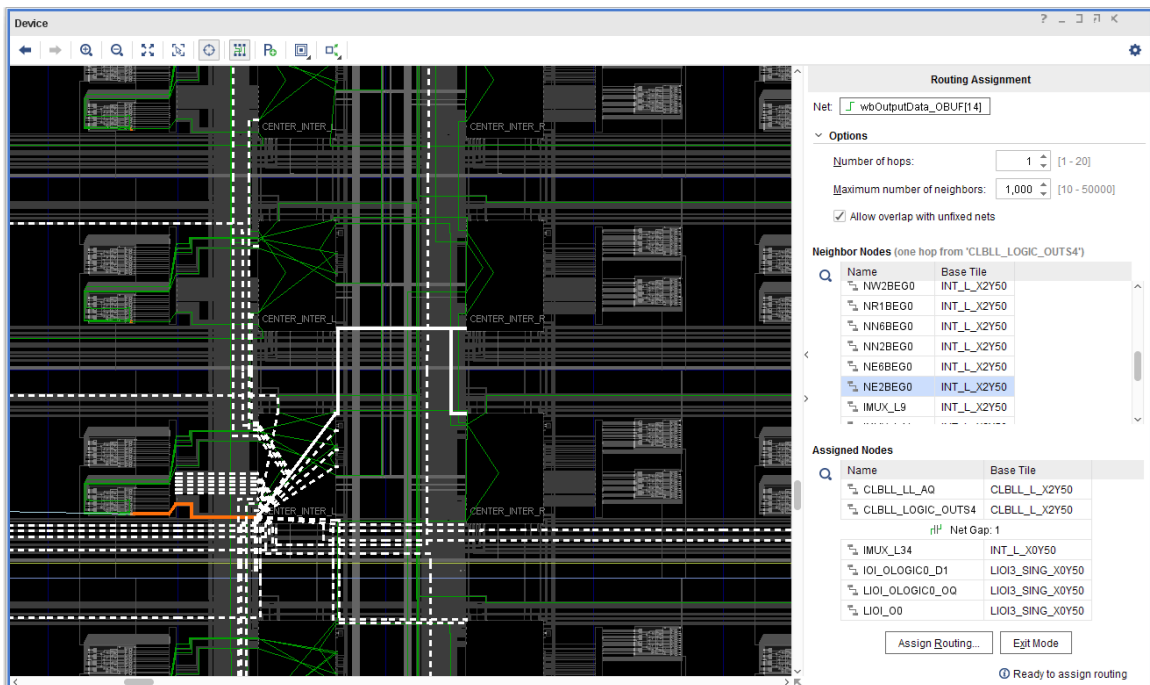

- Under Neighbor Nodes, select node `NE2BEG0`.

This node provides a routing detour to add delay, as compared to some other nodes such as `WW2BEG0`, which provide a more direct route toward the output buffer. Clicking a neighbor node once selects it so you can explore routing alternatives. Double-clicking the node temporarily assigns it to the net, so that you can then select the next neighbor from that node.

10. In Neighbor Nodes, assign node `NE2BEG0` by double-clicking it.

This adds the node to the Assigned Nodes section of the Routing Assignment window, which updates the Neighbor Nodes.

11. In Neighbor Nodes, select and assign nodes `WR1BEG1`, and then `WR1BEG2`.



TIP: In case you assigned the wrong node, you can select the node from the Assigned Nodes list, right-click, and select *Remove* on the context menu.

You can turn off the Auto Fit Selection  in the Device window if you would like to stay at the same zoom level.

The following figure shows the partially routed path using the selected nodes shown in orange. You can use the automatic routing feature to fill the remaining gap.

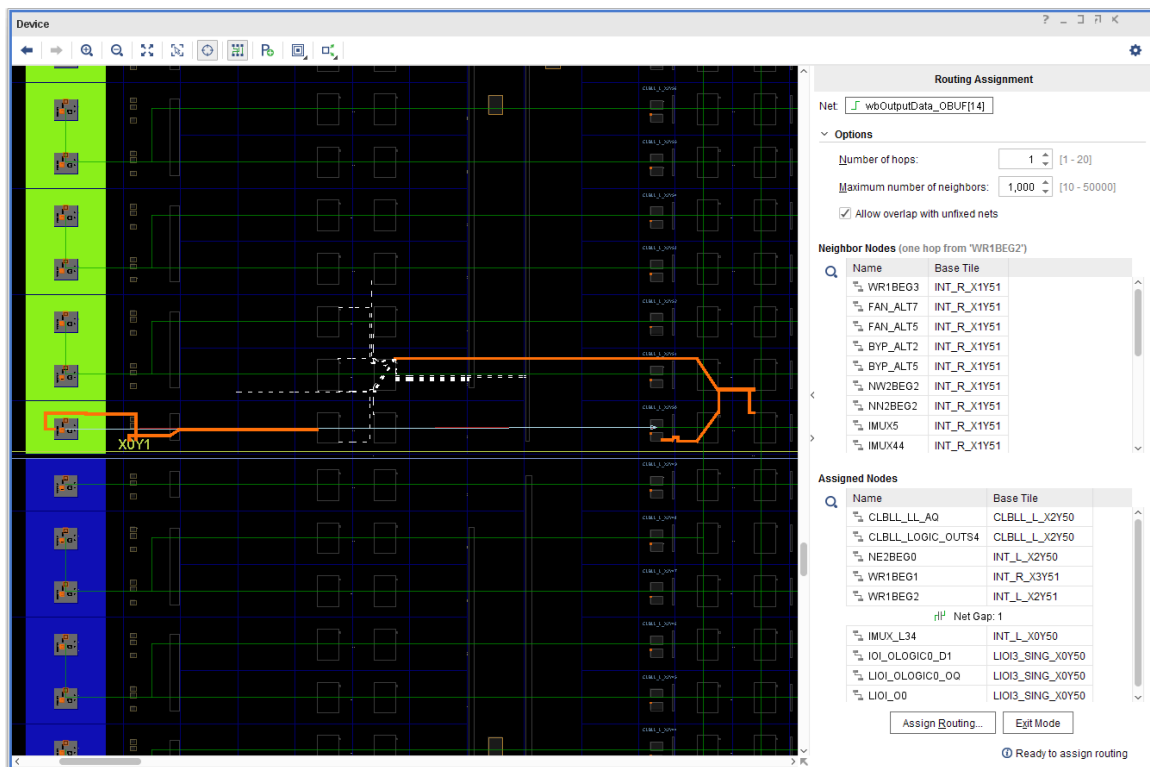

12. Under the Assigned Nodes section of the Routing Assignment window, right-click the **Net Gap**, and select **Auto-Route**, as shown in the following figure.

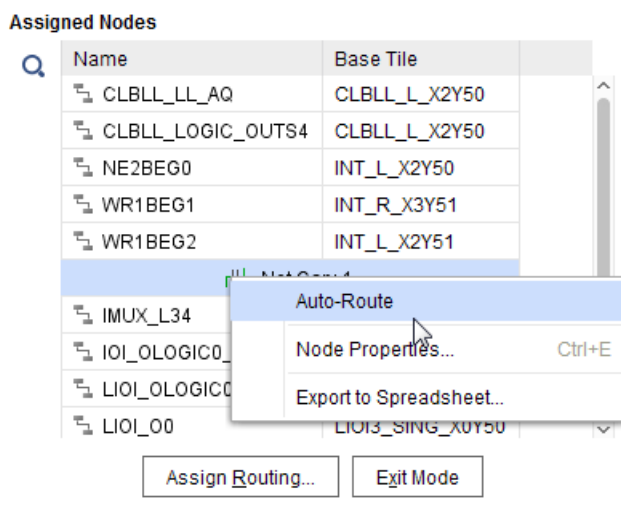

The Vivado router fills in the last small bit of the gap. With the route path fully defined, you can assign the routing to commit the changes to the design.

13. Click **Assign Routing** at the bottom of the Routing Assignment window.

The Assign Routing dialog box opens, as seen in the following figure. This displays the list of currently assigned nodes that define the route path. You can select any of the listed nodes, highlighting it in the Device window. This lets you quickly review the route path prior to committing it to the design.

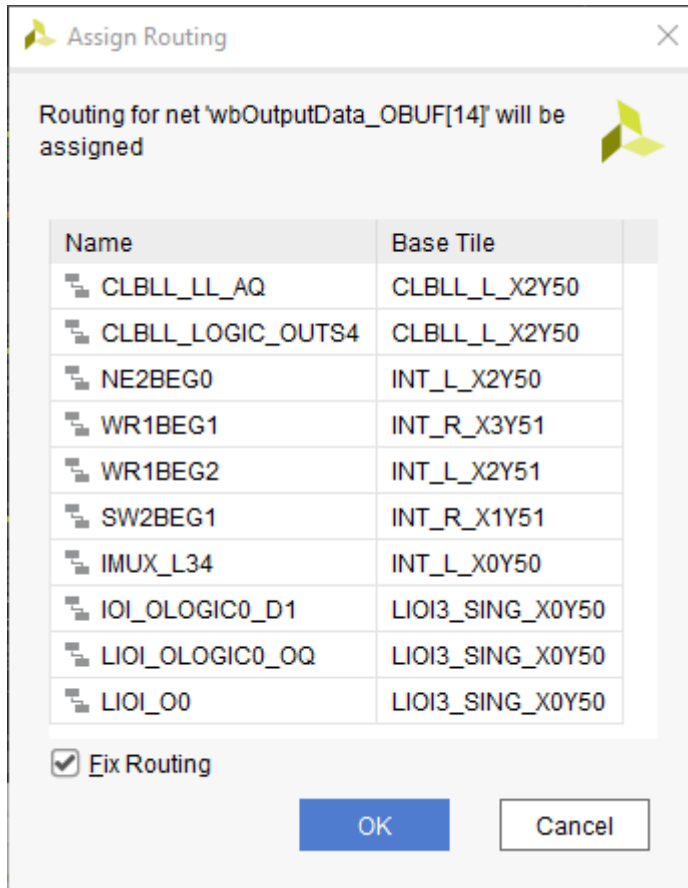

14. Make sure **Fix Routing** is checked, and click **OK**.

The Fix Routing checkbox marks the defined route as fixed to prevent the Vivado router from ripping it up or modifying it during subsequent routing steps. This is important in this case, because you are routing the net manually to add delay to match clock skew.

15. Examine the Tcl commands in the Tcl Console.

The Tcl Console reports any Tcl commands that assigned the routing for the current net. Those commands are:

```
set_property is_bel_fixed 1 [get_cells {wbOutputData_reg[14]
wbOutputData_OBUF[14]_inst } ]
set_property is_loc_fixed 1 [get_cells {wbOutputData_reg[14]
wbOutputData_OBUF[14]_inst } ]
set_property fixed_route { { CLBLL_LL_AQ CLBLL_LOGIC_OUTS4 NE2BEG0
WR1BEG1 WR1BEG2 SW2BEG1 IMUX_L34 IOI_OLOGIC0_D1 LIOI_OLOGIC0_OQ
LIOI_O0 } } [get_nets {wbOutputData_OBUF[14]}]
```



IMPORTANT! The `FIXED_ROUTE` property assigned to the net, `wbOutputData_OBUF[14]`, uses a directed routing string with a relative format, based on the placement of the net driver. This lets you reuse defined routing by copying the `FIXED_ROUTE` property onto other nets that use the same relative route.

After defining the manual route for the even index nets, the next step is to define the route path for the odd index net, `wbOutputData_OBUF[15]`, applying the same steps you just completed.

16. In the Tcl Console type the following to select the net:

```
select_objects [get_nets wbOutputData_OBUF[15]]
```

17. With the net selected:

- a. Unroute the net.
- b. Enter Routing Assignment mode.
- c. Select the load cell pin.
- d. Route the net using the specified neighbor nodes (`NE2BEG0`, `WR1BEG1`, and `WR1BEG2`).
- e. Auto-Route the gap.
- f. Assign the routing.

The Assign Routing dialog box, shown in the following figure, shows the nodes selected to complete the route path for the odd index nets.

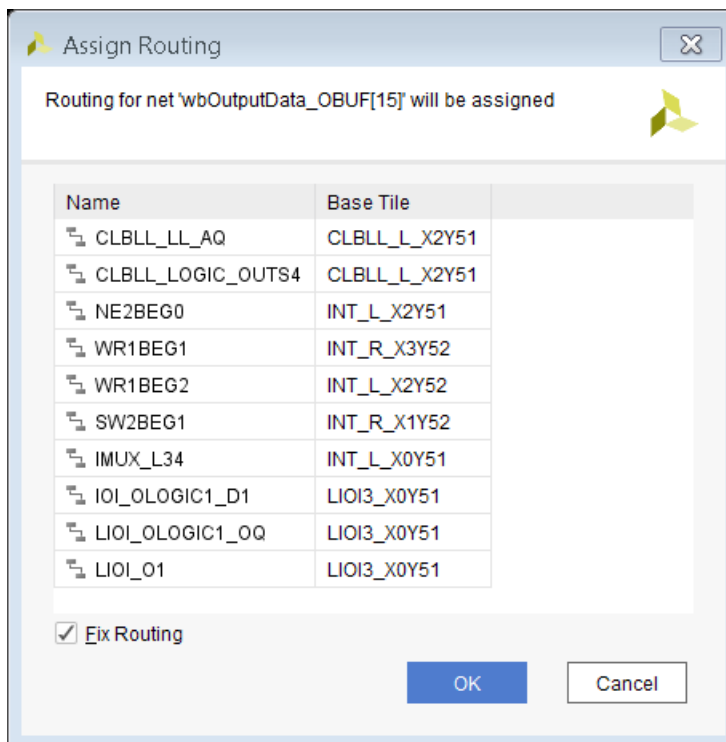

You routed the `wbOutputData_OBUF[14]` and `wbOutputData_OBUF[15]` nets with the detour to add the needed delay. You can now run the Report Datasheet command again to examine the timing for these nets with respect to the lower order bits of the bus.

18. Switch to the Timing Datasheet report window. Notice the information message in the banner of the window indicating that the report is out of date because the design was modified.
19. In the Timing Datasheet report, click Rerun to update the report with the latest timing information.
20. Select **Max/Min Delays for Groups → Clocked by wbClk → wbOutputData[0]** to display the timing info for the `wbOutputData` bus, as seen in the following figure.

Pad	Max Delay	Max Edge	Max Process Corner	Min Delay	Min Edge	Min Process Corner	Edge Skew
wbOutputData[31]	7.720	Rise	SLOW	3.236	Rise	FAST	0.190
wbOutputData[30]	7.697	Rise	SLOW	3.213	Rise	FAST	0.213
wbOutputData[29]	7.705	Rise	SLOW	3.221	Rise	FAST	0.205
wbOutputData[28]	7.707	Rise	SLOW	3.222	Rise	FAST	0.204
wbOutputData[27]	7.715	Rise	SLOW	3.228	Rise	FAST	0.196
wbOutputData[26]	7.688	Rise	SLOW	3.201	Rise	FAST	0.223
wbOutputData[25]	7.694	Rise	SLOW	3.208	Rise	FAST	0.217
wbOutputData[24]	7.695	Rise	SLOW	3.208	Rise	FAST	0.215
wbOutputData[23]	7.701	Rise	SLOW	3.214	Rise	FAST	0.210
wbOutputData[22]	7.687	Rise	SLOW	3.200	Rise	FAST	0.224
wbOutputData[21]	7.691	Rise	SLOW	3.203	Rise	FAST	0.220
wbOutputData[20]	7.723	Rise	SLOW	3.236	Rise	FAST	0.188
wbOutputData[19]	7.730	Rise	SLOW	3.242	Rise	FAST	0.181
wbOutputData[18]	7.678	Rise	SLOW	3.191	Rise	FAST	0.233
wbOutputData[17]	7.681	Rise	SLOW	3.193	Rise	FAST	0.230
wbOutputData[16]	7.718	Rise	SLOW	3.231	Rise	FAST	0.193
wbOutputData[15]	7.987	Rise	SLOW	3.366	Rise	FAST	0.076
wbOutputData[14]	7.949	Rise	SLOW	3.328	Rise	FAST	0.038
wbOutputData[13]	7.942	Rise	SLOW	3.336	Rise	FAST	0.032
wbOutputData[12]	7.891	Rise	SLOW	3.284	Rise	FAST	0.019
wbOutputData[11]	7.897	Rise	SLOW	3.290	Rise	FAST	0.014
wbOutputData[10]	7.905	Rise	SLOW	3.297	Rise	FAST	0.007
wbOutputData[9]	7.914	Rise	SLOW	3.306	Rise	FAST	0.004
wbOutputData[8]	7.886	Rise	SLOW	3.278	Rise	FAST	0.025
wbOutputData[7]	7.881	Rise	SLOW	3.274	Rise	FAST	0.030
wbOutputData[6]	7.915	Rise	SLOW	3.306	Rise	FAST	0.004
wbOutputData[5]	7.919	Rise	SLOW	3.311	Rise	FAST	0.008
wbOutputData[4]	7.868	Rise	SLOW	3.261	Rise	FAST	0.043
wbOutputData[3]	7.874	Rise	SLOW	3.267	Rise	FAST	0.037
wbOutputData[2]	7.875	Rise	SLOW	3.269	Rise	FAST	0.035
wbOutputData[1]	7.878	Rise	SLOW	3.271	Rise	FAST	0.033
wbOutputData[0]	7.911	Rise	SLOW	3.303	Rise	FAST	0.000
wbOutputData[0]	7.911	Rise	SLOW	3.303	Rise	FAST	0.000
Worst Case Summary	7.987	Rise	SLOW	3.191	Rise	FAST	0.233

Bus Skew: 0.233 ns

You can see from the report that the skew within the rerouted nets, `wbOutputData[14]` and `wbOutputData[15]`, more closely matches the timing of the lower bits of the output bus, `wbOutputData[13:0]`. The skew is within the target of 100 ps of the reference pin `wbOutputData[0]`.

In Step 6, you copy the same route path to the remaining nets, `wbOutputData_OBUF[31:16]`, to tighten the timing of the whole `wbOutputData` bus.

Step 6: Copying Routing to Other Nets

To apply the same fixed route used for net `wbOutputData_OBUF[14]` to the even index nets, and the fixed route for `wbOutputData_OBUF[15]` to the odd index nets, you can use Tcl For loops as described in the following steps.

1. Select the **Tcl Console** tab.
2. Set a Tcl variable to store the route path for the even nets and the odd nets:

```
set even [get_property FIXED_ROUTE [get_nets wbOutputData_OBUF[14]]]
set odd [get_property FIXED_ROUTE [get_nets wbOutputData_OBUF[15]]]
```

3. Set a Tcl variable to store the list of nets to be routed, containing all high bit nets of the output data bus, `wbOutputData_OBUF[16:31]`:

```
for {set i 16} {$i<32} {incr i} {
    lappend routeNets [get_nets wbOutputData_OBUF[$i]]
}
```

4. Unroute the specified nets:

```
route_design -unroute -nets $routeNets
```

5. Apply the `FIXED_ROUTE` property of net `wbOutputData_OBUF[14]` to the even nets:

```
for {set i 16} {$i<32} {incr i 2} {
    set_property FIXED_ROUTE $even [get_nets wbOutputData_OBUF[$i]]
}
```

6. Apply the `FIXED_ROUTE` property of net `wbOutputData_OBUF[15]` to the odd nets:

```
for {set i 17} {$i<32} {incr i 2} {
    set_property FIXED_ROUTE $odd [get_nets wbOutputData_OBUF[$i]]
}
```

The even and odd nets of the output data bus, as needed, now have the same routing paths, adding delay to the high order bits. Run the route status report and the datasheet report to validate that the design is as expected.

7. In the Tcl Console, type the following command:

```
report_route_status
```



TIP: Some routing errors might be reported if the routed design included nets that use some of the nodes you have assigned to the `FIXED_ROUTE` properties of the manually routed nets. Remember you enabled `Allow Overlap with Unfixed Nets` in the Routing Assignment window.

8. If any routing errors are reported, type the `route_design` command in the Tcl Console. The nets with the `FIXED_ROUTE` property takes precedence over the auto-routed nets.
9. After `route_design`, repeat the `report_route_status` command to see the clean report.
10. Examine the output data bus in the Device window, as seen in the following figure:
 - All nets from the output registers to the output pins for the upper bits 14-31 of the output bus `wbOutputData` have identical fixed routing sections (shown as dashed lines).
 - You do not need to fix the `LOC` and the `BEL` for the output registers. It was done by the `place_cell` command in an earlier step.

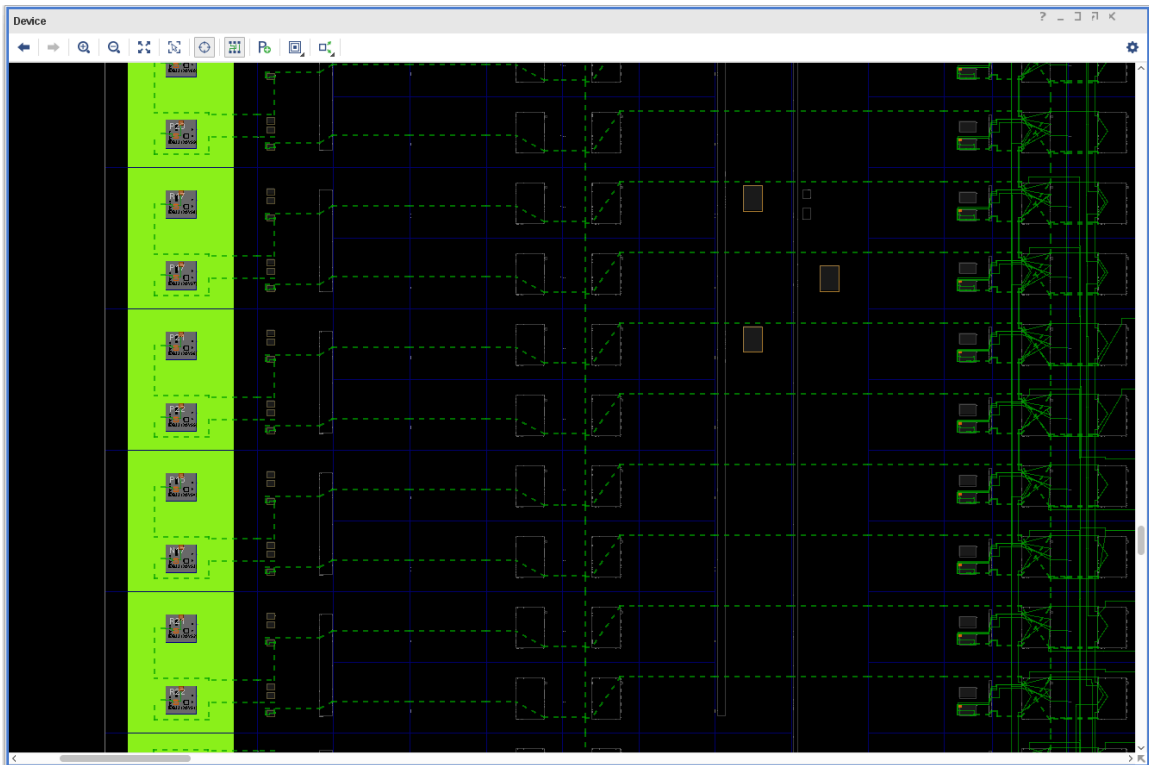

Having routed all the upper bit nets, `wbOutputData_OBUF[31:14]`, with the detour needed for added delay, you can now re-examine the timing of output bus.

11. Select the **Timing** window.

Notice the information message in the banner of the window indicating that the report is out of date because timing data has been modified.

12. Click **rerun** to update the report with the latest timing information.

13. Select the **Max/Min Delays for Groups** → **Clocked by wbClk** → **wbOutputData[0]** section to display the timing info for the `wbOutputData` bus.

The clock-to-out timing within all bits of output bus `wbOutputData` is now closely matched to within 83 ps.

14. Save the constraints to write them to the target XDC, so that they apply every time you compile the design.
15. Select **File** → **Constraints** → **Save** to save the placement constraints to the target constraint file, `bft_full.xdc`, in the active constraint set, `constrs_1`.

The synthesis and implementation will go out-of-date since constraints were updated. You can force the design to update by clicking on **Details** in tool bar, since new constraints are already applied.

Timing

Max/Min Delays for Groups - Clocked by wbClk - wbOutputData[0]

Pad	Max Delay	Max Edge	Max Process Corner	Min Delay	Min Edge	Min Process Corner	Edge Skew
wbOutputData[0]	7.911	Rise	SLOW	3.303	Rise	FAST	0.000
wbOutputData[31]	7.984	Rise	SLOW	3.366	Rise	FAST	0.073
wbOutputData[30]	7.961	Rise	SLOW	3.343	Rise	FAST	0.050
wbOutputData[29]	7.969	Rise	SLOW	3.351	Rise	FAST	0.058
wbOutputData[28]	7.970	Rise	SLOW	3.351	Rise	FAST	0.059
wbOutputData[27]	7.978	Rise	SLOW	3.357	Rise	FAST	0.067
wbOutputData[26]	7.951	Rise	SLOW	3.331	Rise	FAST	0.041
wbOutputData[25]	7.958	Rise	SLOW	3.338	Rise	FAST	0.047
wbOutputData[24]	7.959	Rise	SLOW	3.338	Rise	FAST	0.048
wbOutputData[23]	7.965	Rise	SLOW	3.344	Rise	FAST	0.054
wbOutputData[22]	7.951	Rise	SLOW	3.330	Rise	FAST	0.040
wbOutputData[21]	7.955	Rise	SLOW	3.333	Rise	FAST	0.044
wbOutputData[20]	7.986	Rise	SLOW	3.365	Rise	FAST	0.076
wbOutputData[19]	7.994	Rise	SLOW	3.371	Rise	FAST	0.083
wbOutputData[18]	7.942	Rise	SLOW	3.320	Rise	FAST	0.031
wbOutputData[17]	7.945	Rise	SLOW	3.323	Rise	FAST	0.034
wbOutputData[16]	7.981	Rise	SLOW	3.360	Rise	FAST	0.070
wbOutputData[15]	7.987	Rise	SLOW	3.366	Rise	FAST	0.076
wbOutputData[14]	7.949	Rise	SLOW	3.328	Rise	FAST	0.038
wbOutputData[13]	7.942	Rise	SLOW	3.336	Rise	FAST	0.032
wbOutputData[12]	7.891	Rise	SLOW	3.284	Rise	FAST	0.019
wbOutputData[11]	7.897	Rise	SLOW	3.290	Rise	FAST	0.014
wbOutputData[10]	7.905	Rise	SLOW	3.297	Rise	FAST	0.007
wbOutputData[9]	7.914	Rise	SLOW	3.306	Rise	FAST	0.004
wbOutputData[8]	7.886	Rise	SLOW	3.278	Rise	FAST	0.025
wbOutputData[7]	7.881	Rise	SLOW	3.274	Rise	FAST	0.030
wbOutputData[6]	7.915	Rise	SLOW	3.306	Rise	FAST	0.004
wbOutputData[5]	7.919	Rise	SLOW	3.311	Rise	FAST	0.008
wbOutputData[4]	7.868	Rise	SLOW	3.261	Rise	FAST	0.043
wbOutputData[3]	7.874	Rise	SLOW	3.267	Rise	FAST	0.037
wbOutputData[2]	7.875	Rise	SLOW	3.269	Rise	FAST	0.035
wbOutputData[1]	7.878	Rise	SLOW	3.271	Rise	FAST	0.033
wbOutputData[0]	7.911	Rise	SLOW	3.303	Rise	FAST	0.000
Worst Case Summary	7.994	Rise	SLOW	3.261	Rise	FAST	0.083

Bus Skew: 0.083 ns

Datasheet - timing_2

Conclusion

In this lab, you did the following:

- Analyzed the clock skew on the output data bus using the Report Datasheet command.

- Used manual placement techniques to improve the timing of selected nets.
- Used the Assign Manual Routing Mode in the Vivado IDE to precisely control the routing of a net.
- Used the FIXED_ROUTE property to copy the relative fixed routing among similar nets to control the routing of the critical portion of the nets.

Vivado ECO Flow

In this lab, you will learn how to use the Vivado® Engineering Change Order (ECO) flow to modify your design post implementation, implement the changes, run reports on the changed netlist, and generate programming files.

For this lab, you will use the design file that is included with this guide and is targeted at the Kintex® UltraScale™ KCU105 Evaluation Platform. For instructions on locating the design files, see Locating Design Files for Lab 4.

A block diagram of the design is shown in the following figure.

Figure 3: Block Diagram of the Design

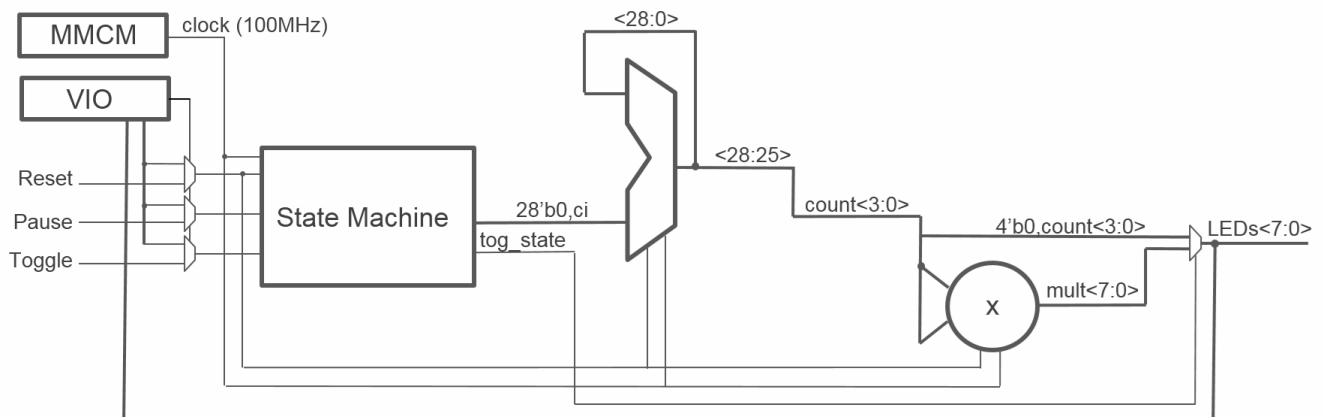

In this design, a mixed-mode clock manager (MMCM) is used to synthesize a 100 MHz clock from the 300 MHz clock provided by the board.

A 29-bit counter is used to divide the clock down further. The four most significant bits of the counter form the `count<3:0>` signal that is 0-extended to 8 bits and drives the 8 on-board LEDs through an 8-bit 2-1 mux.

The `count<3:0>` signal is also squared using a multiplier, and the product drives the other eight inputs of the mux. A `Toggle` signal controls the mux select and either drives the LEDs (shown in the following figure) with the counter value or the multiplier output.

A `Pause` signal allows you to stop the counter, and a `Reset` signal allows you to reset the design. The `Toggle`, `Pause`, and `Reset` signals can either be controlled from on-board buttons shown in the following figure or a VIO in the Hardware Manager as shown in the subsequent figure. The VIO also allows you to observe the status of the LEDs. The following figures show the location of the push-buttons and the LEDs on the KCU105 board and a Hardware Manager dashboard.

Figure 4: KCU105 On-Board Push Buttons and LEDs

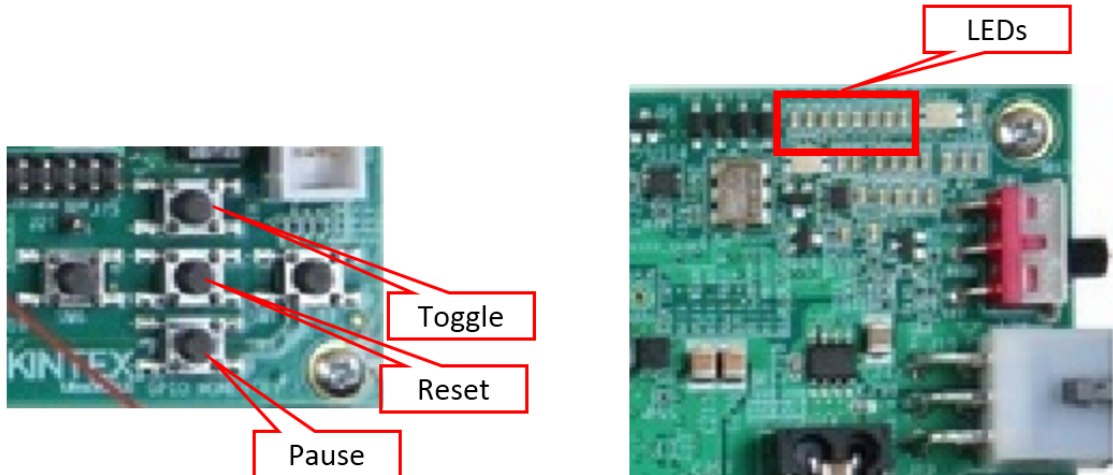

Figure 5: VIO Dashboard

Name	Value	Acti...	Directi...	VIO
count_out_OBUF[7:0]	[U] 100		Input	hw_vio_1
count_out_OBUF...	●		Input	hw_vio_1
count_out_OBUF...	●		Input	hw_vio_1
count_out_OBUF...	●		Input	hw_vio_1
count_out_OBUF...	●		Input	hw_vio_1
count_out_OBUF...	●		Input	hw_vio_1
count_out_OBUF...	●		Input	hw_vio_1
count_out_OBUF...	●		Input	hw_vio_1
count_out_OBUF...	●		Input	hw_vio_1
pause_vio_out	0		Output	hw_vio_1
reset_vio_out	0		Output	hw_vio_1
toggle_vio_out	0		Output	hw_vio_1
vio_select	1		Output	hw_vio_1

Related Information

[Locating Design Files for Lab 4](#)

Step 1: Creating a Project Using the Vivado New Project Wizard

To create a project, use the New Project wizard to name the project, to add RTL source files and constraints, and to specify the target device.

1. Open the Vivado Design Suite integrated design environment (IDE).
2. In the Getting Started page, click **Create Project** to open the New Project wizard.
3. Click **Next**.
4. In the Project Name page, do the following:
 - a. Name the new project `project_ECO_lab`.
 - b. Provide the project location `C:/Vivado_Tutorial`.
 - c. Ensure that Create project subdirectory is selected.
 - d. Click **Next**.
5. In the Project Type page, do the following:
 - a. Specify the type of project to create as **RTL Project**.
 - b. Leave the Do not specify sources at this time check box unchecked.
 - c. Click **Next**.
6. In the Add Sources page, do the following:
 - a. Set the Target Language to Verilog.
 - b. Click **Add Files**.
 - c. In the Add Source Files dialog box, navigate to the `/src/lab4` directory.
 - d. Select all Verilog source files.
 - e. Click **OK**.
 - f. Verify that the files are added.
 - g. Click **Add Files**.
 - h. In the Add Source Files dialog box, navigate to the `/src/lab4/IP` directory.
 - i. Select all of the XCI source files and click **OK**.
 - j. Verify that the files are added and **Copy sources into project** is selected.

- k. Click **Next**.
7. In the Add Constraints dialog box, do the following:
 - a. Click the Add button , and then select **Add Files**.
 - b. Navigate to the `/src/lab4` directory and select **ECO_kcu105.xdc**.
 - c. Click **Next**.
8. In the Default Part page, do the following:
 - a. Select **Boards** and then select **Kintex-UltraScale KCU105 Evaluation Platform**.
 - b. Click **Next**.
9. Review the New Project Summary page. Verify that the data appears as expected, per the steps above.
10. Click **Finish**.

Note: It might take a moment for the project to initialize.
11. In the Sources window in the Vivado IDE, expand top to see the source files for this lab.

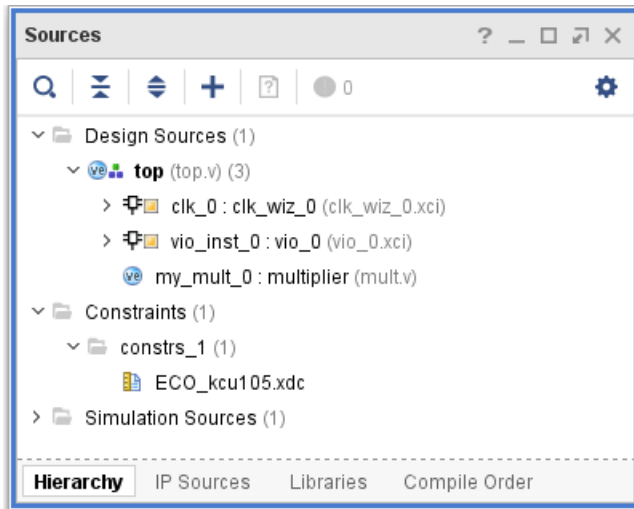

Step 2: Synthesizing, Implementing, and Generating the Bitstream

1. In the Flow Navigator, under Program and Debug, click **Generate Bitstream**.

This synthesizes, implements, and generates a bitstream for the design.

The No Implementation Results Available dialog box appears.
2. Click **Yes**.

After bitstream generation completes, the Bitstream Generation Completed dialog box appears. Open Implemented Design is selected by default.

3. Click **OK**.
4. Inspect the Timing Summary report and make sure that all timing constraints have been met.

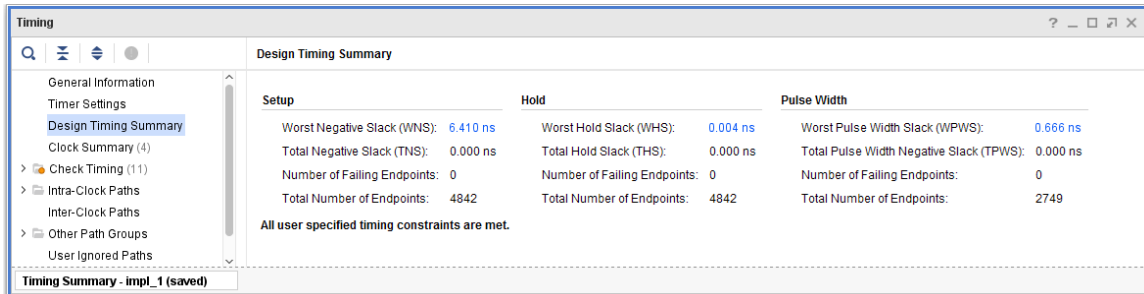

Setup	Hold	Pulse Width
Worst Negative Slack (WNS): 6.410 ns	Worst Hold Slack (WHS): 0.004 ns	Worst Pulse Width Slack (WPWS): 0.666 ns
Total Negative Slack (TNS): 0.000 ns	Total Hold Slack (THS): 0.000 ns	Total Pulse Width Negative Slack (TPWS): 0.000 ns
Number of Failing Endpoints: 0	Number of Failing Endpoints: 0	Number of Failing Endpoints: 0
Total Number of Endpoints: 4842	Total Number of Endpoints: 4842	Total Number of Endpoints: 2749

All user specified timing constraints are met.

You can use the generated bitstream programming file to download your design into the target FPGA device using the Hardware Manager. For more information, see the *Vivado Design Suite User Guide: Programming and Debugging* (UG908).

Step 3: Validating the Design on the Board

This step is optional, but will help you understand the ECO modifications that you will make in Step 4: Making the ECO Modifications.

1. From the main menu, select **Flow** → **Open Hardware Manager**.

The Hardware Manager window opens.

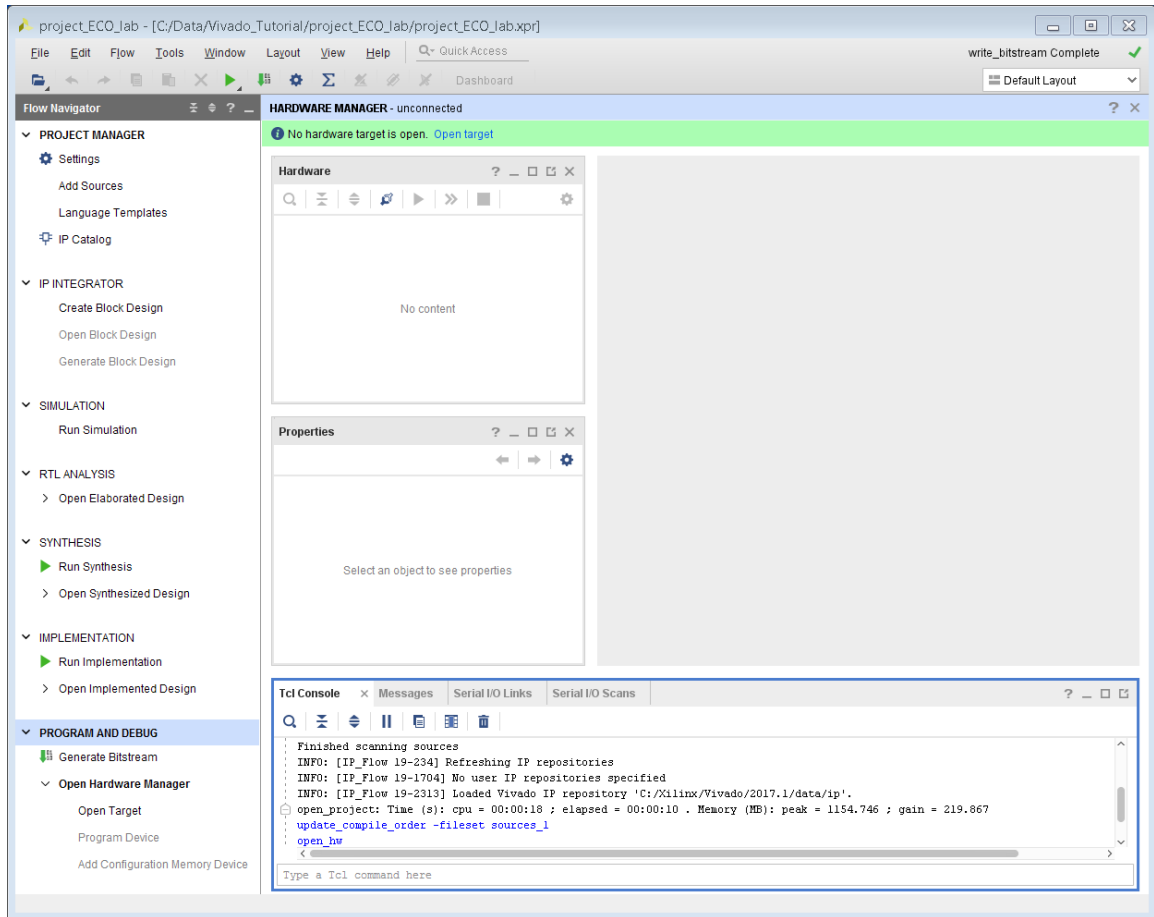

2. Connect to a hardware target using `hw_server`.



TIP: For more information about different ways to connect to a hardware target, refer to the *Vivado Design Suite User Guide: Programming and Debugging (UG908)*.

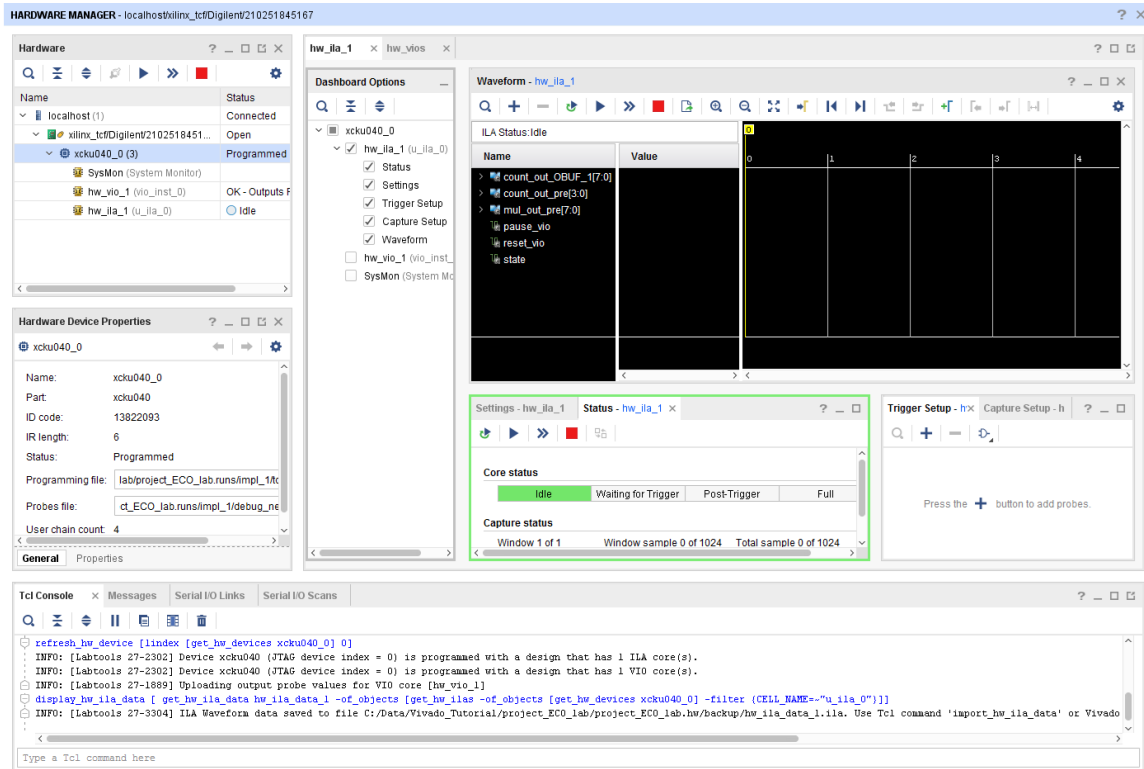

3. In the Vivado Flow Navigator, under Program and Debug, click Program Device.
The Program Device dialog box opens.

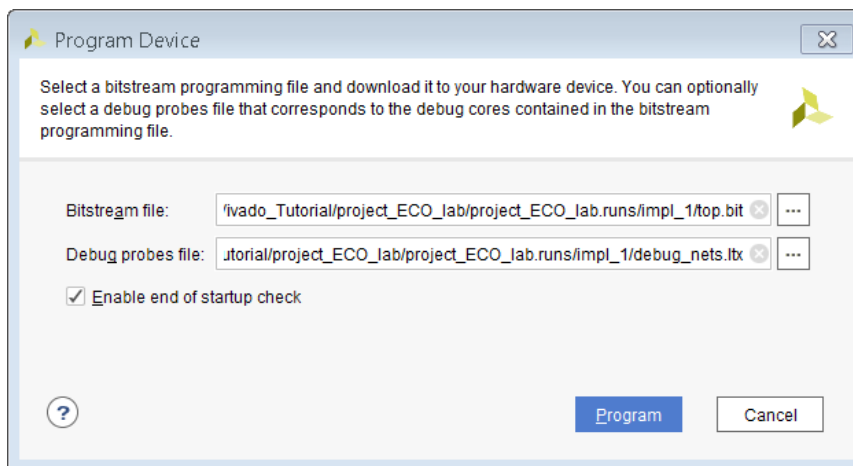

4. Navigate to the Bitstream file and Debug Probes file.
5. Click **Program**.

Now that the FPGA is configured, you can use the on-board buttons and the on-board LEDs to control and observe the hardware. Press the **Pause** button to pause the counter. Press the **Toggle** button to select between the count and the multiplier result. Press the **Reset** button to reset the counter.

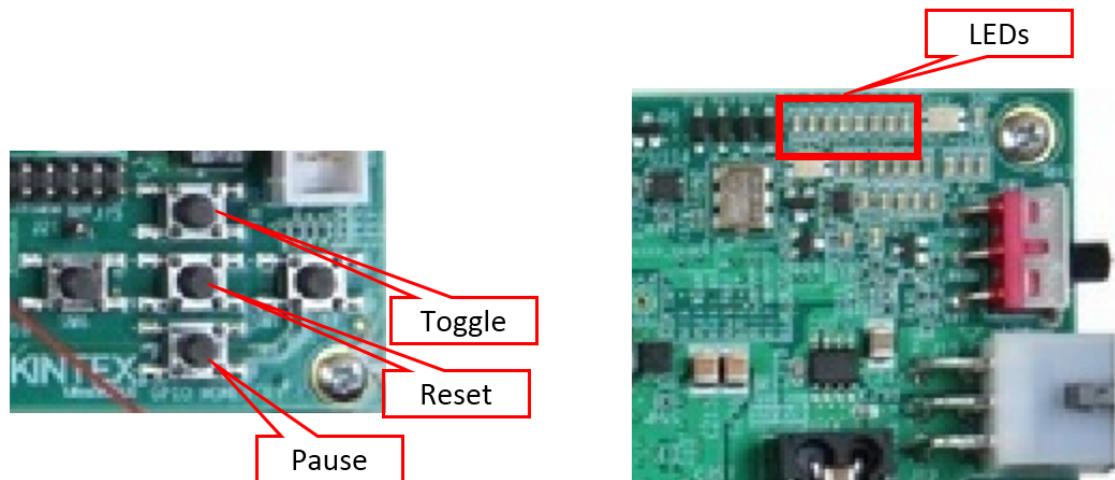

Alternatively, you can use the VIO to control and observe the hardware.

If the following warning message appears, select one of the alternatives suggested in the message.

```
WARNING: [Labtools 27-1952] VIO hw_probe OUTPUT_VALUE properties for
hw_vio(s) [hw_vio_1] differ from output values in the VIO core(s).
Resolution:
To synchronize the hw_probes properties and the VIO core outputs choose
one of the following alternatives:
  1) Execute the command 'Commit Output Values to VIO Core', to write
down the hw_probe values to the core.
  2) Execute the command 'Refresh Input and Output Values from VIO
Core', to update the hw_probe properties with the core values.
  3) First restore initial values in the core with the command 'Reset
VIO Core Outputs', and then execute the command 'Refresh Input and
Output Values from VIO Core'.
```

6. Select the **hw_vios** tab in the dashboard and click the **Add** button  to add probes.

The Add Probes dialog box opens.

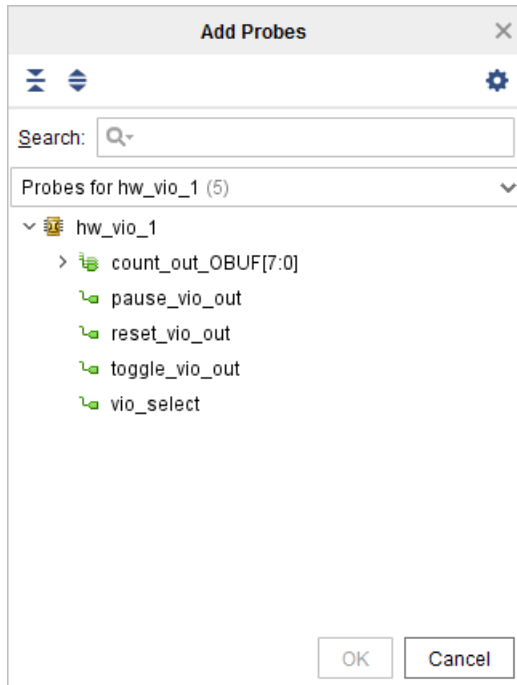

7. Select all of the probes for `hw_vio_1` and click **OK**.
8. In the `hw_vios` dashboard, select `count_out_OBUF[7:0]`, then right-click and select **Radix** → **Unsigned Decimal**.

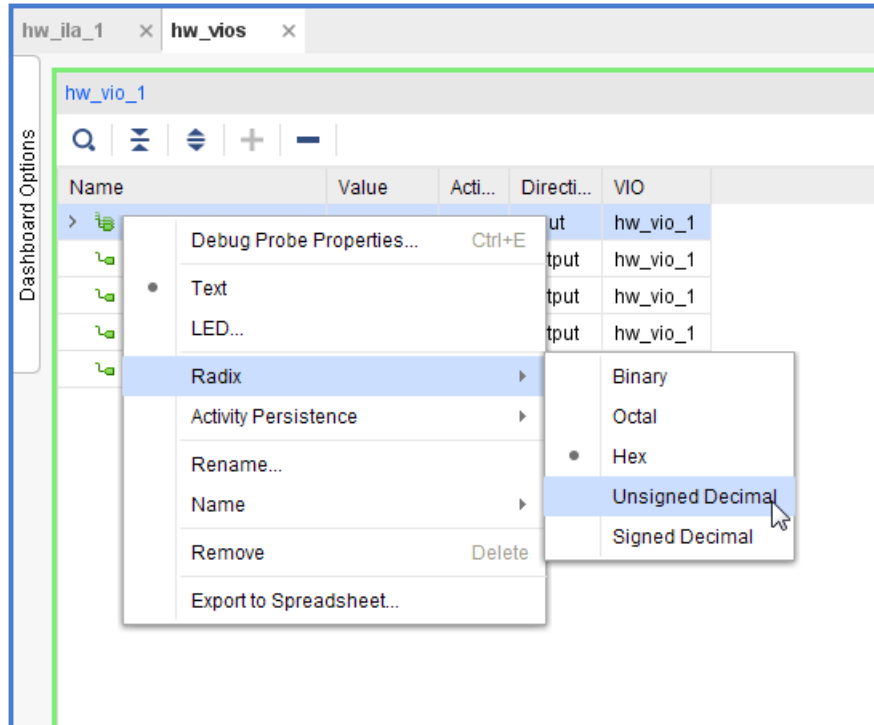

9. In the `hw_vios` dashboard, select `count_out_OBUF[7:0]`, then right-click and select **LED**.
The Select LED Colors dialog box opens.

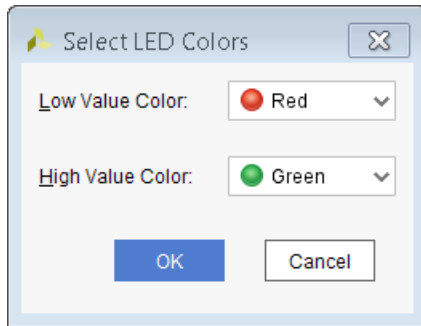

10. Select **Red** for the Low Value Color and **Green** for the High Value Color.
11. Click **OK**.
12. In the `hw_vios` dashboard, select `pause_vio_out`, `reset_vio_out`, and `toggle_vio_out`, then right-click and select **Active-High Button**.

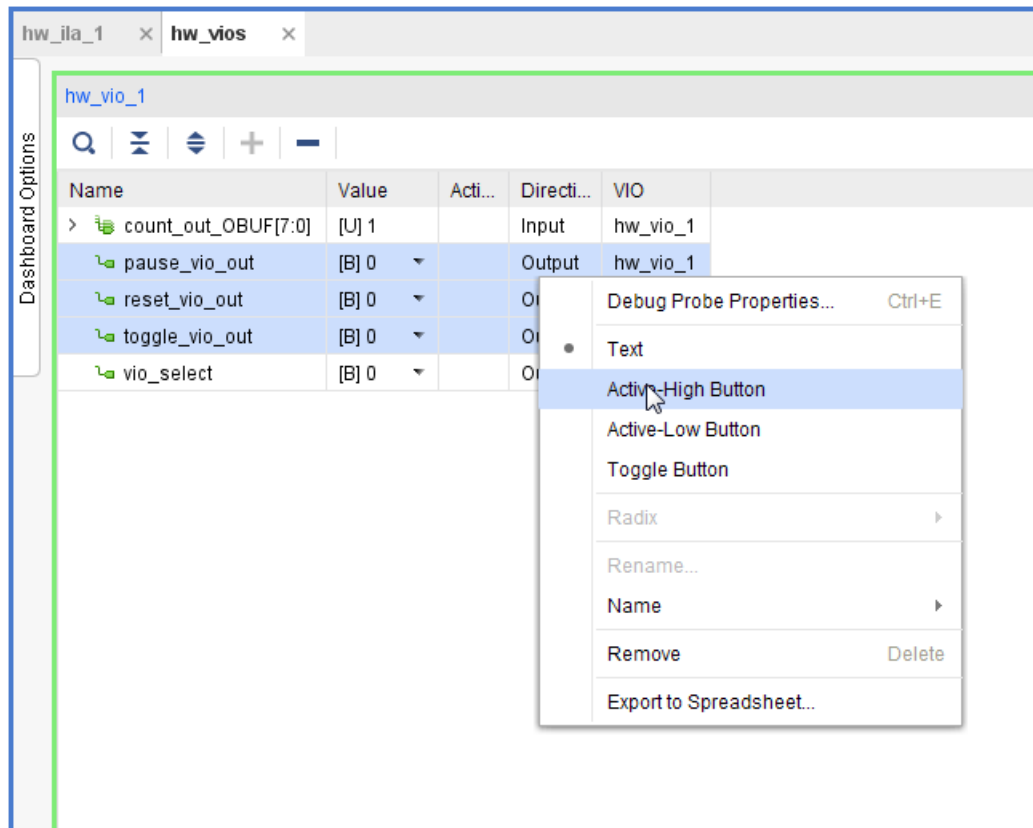

13. In the `hw_vios` dashboard, right-click `vio_select` and select **Toggle Button**.

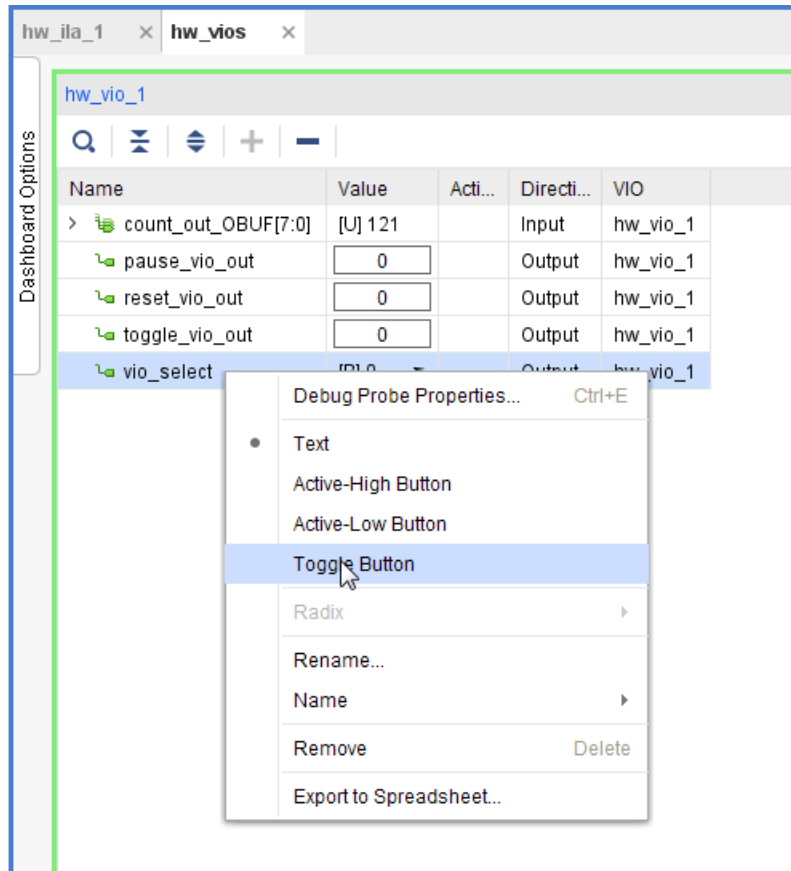

14. Expand **count_out_OBUF[7:0]** to view the VIO LEDs.

Now that the VIO is set up, you are ready to analyze the design.

15. Toggle the **vio_select** button to control the hardware from the VIO.

16. Press the **pause_vio_out** button to pause the counter.

17. Press the **toggle_vio_out** button to select between the count and the multiplier result.

18. Press the **reset_vio_out** button to reset the counter.

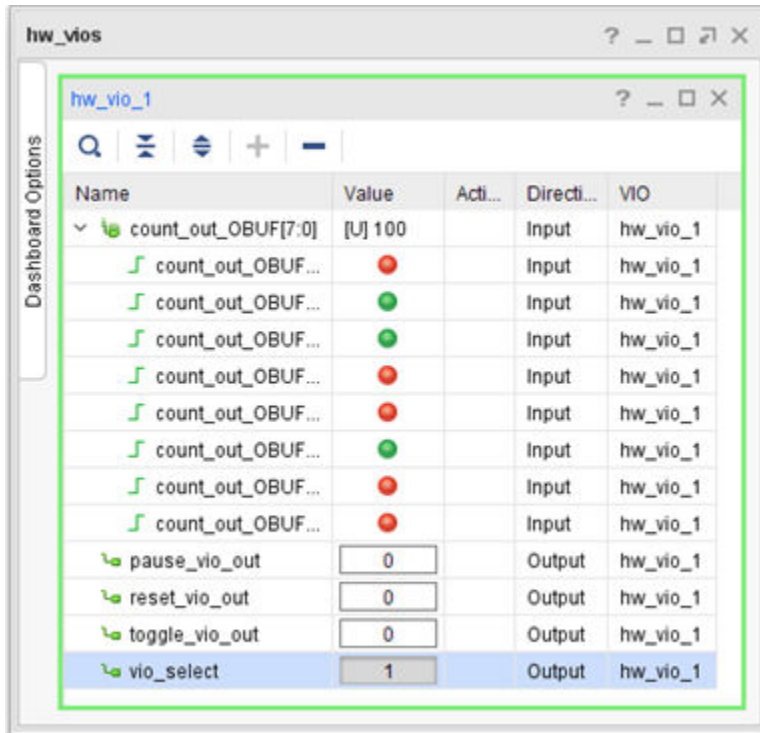

Step 4: Making the ECO Modifications

1. In the Flow Navigator, select the **Project Manager**.
2. In the Design Runs window, right-click on **impl_1** and select **Open Run Directory**.
3. The run directory opens in a file browser, as seen in the following figure. The run directory contains the routed checkpoint (`top_routed.dcp`) to be used for the ECO flow.



TIP: In a project-based design, the Vivado Design Suite saves intermediate implementation results as design checkpoints in the implementation runs directory. When you re-run implementation, the previous results are deleted. Save the router checkpoint to a new directory to preserve the modified checkpoint.

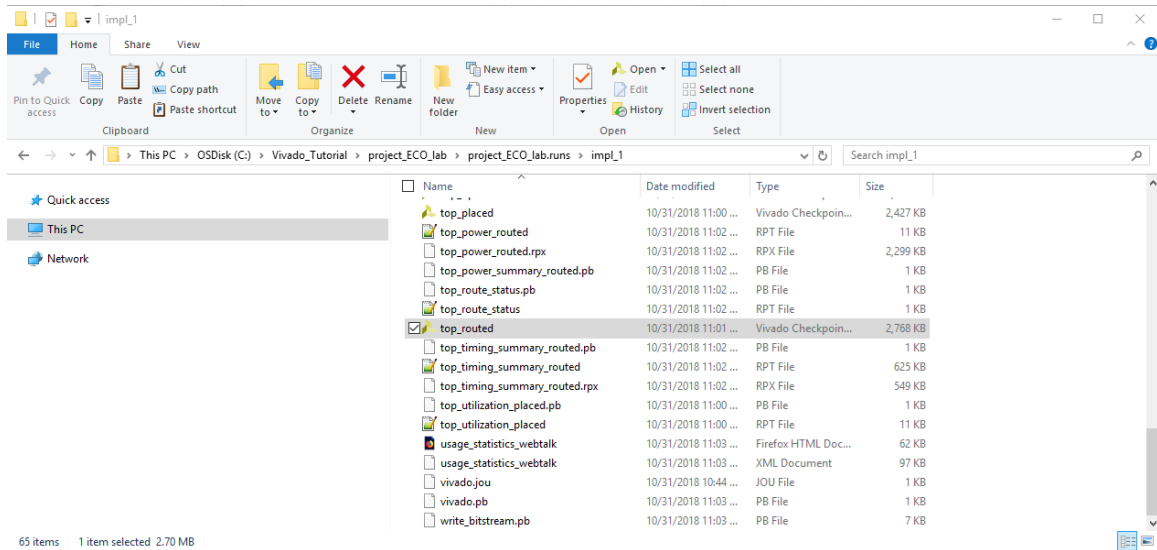

4. Create a new directory named `ECO` in the original `C:\Vivado_Tutorial\project_ECO_lab` project directory, and copy the `top_routed.dcp` file from the implementation runs directory to that newly created directory.

5. From the main menu, select **File** → **Checkpoint** → **Open**.

The Open Checkpoint dialog box opens.

6. Navigate to `C:\Vivado_Tutorial\project_ECO_lab\ECO` and select the **top_routed.dcp** checkpoint.

A dialog box opens, asking whether to close the current project.

7. Click **Yes**.

8. From the main menu, select **Layout** → **ECO**.

The ECO Layout is selected. The ECO Navigator is displayed on the left of the layout (highlighted in red in the following figure). It provides access to netlist commands, run steps, report and analysis tools, and commands to save changes and generate programming files.

The Scratch Pad in the center of the layout (highlighted in red in the following figure) tracks netlist changes, as well as place and route status for cells, pins, ports, and nets.

Note: ECOs only work on design checkpoints. The ECO layout is only available after you have opened a design checkpoint in the Vivado IDE.

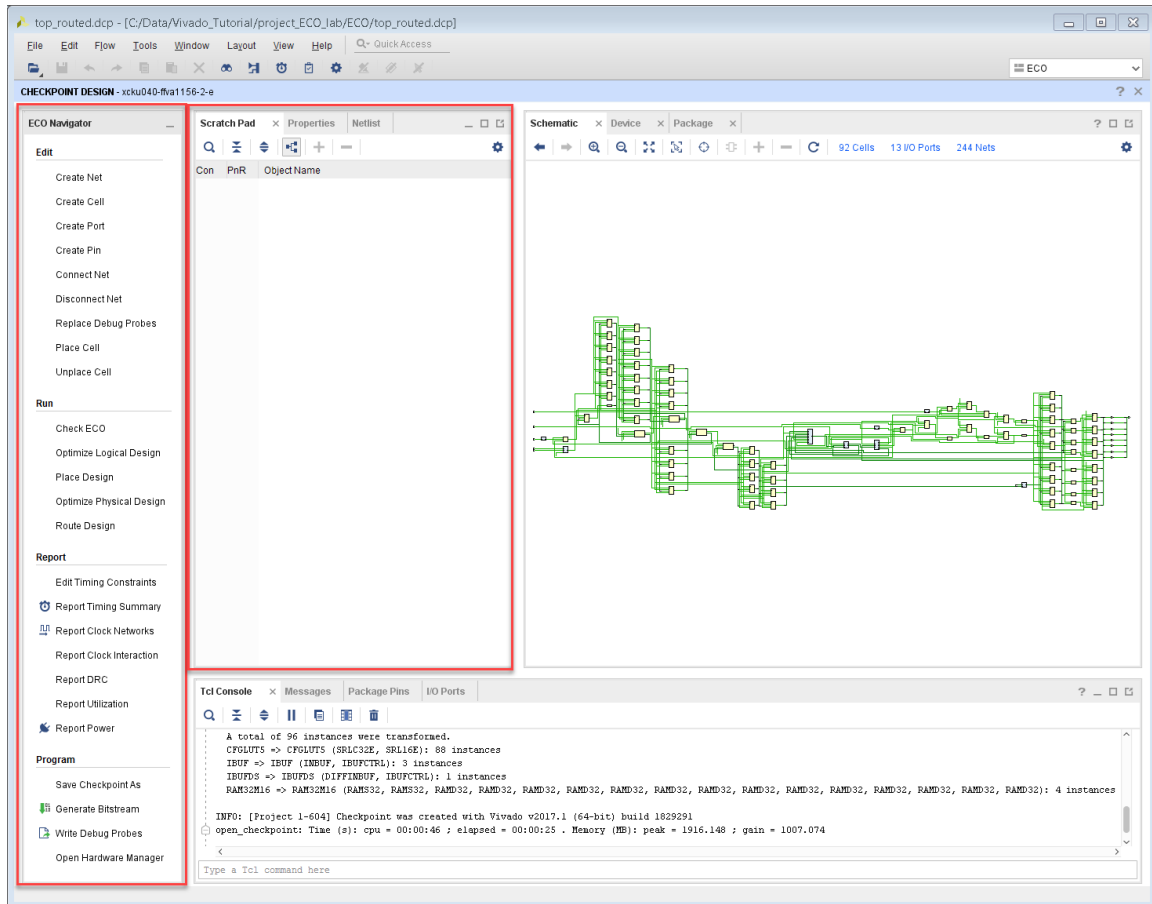

To illustrate the capabilities of the ECO flow, you next change the functionality of the multiplier from a square of `count [3 : 0]` to a multiply by two.

- From the Tcl Console, type the following command:

```
mark_objects -color blue [get_cells my_mult_0]
```



TIP: To make it easier to locate objects that are included in the ECO modifications, it helps to mark or highlight the objects with different colors.

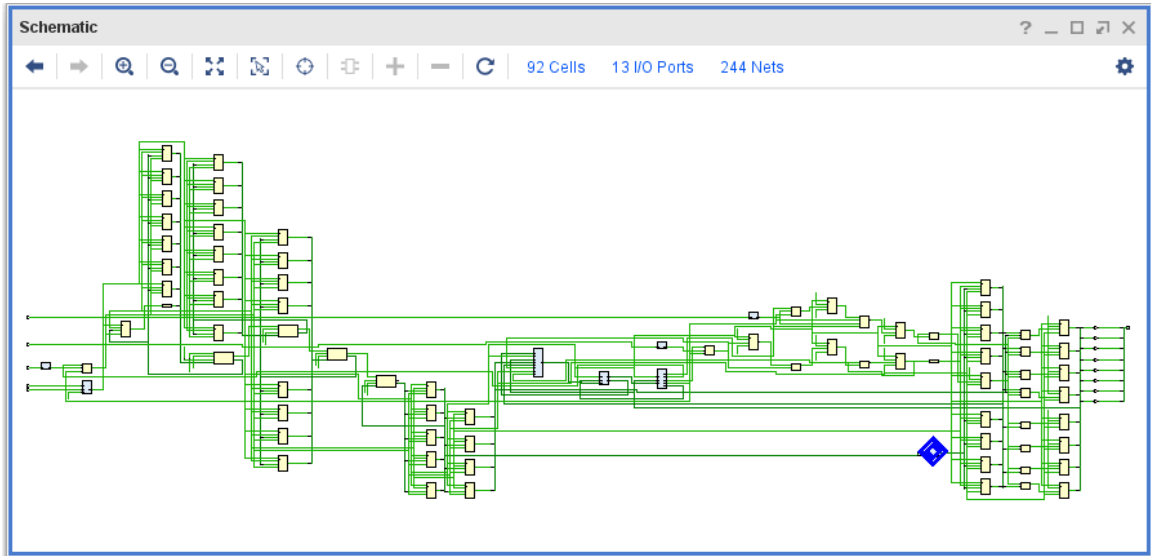

10. Zoom into the multiplier in the schematic window and select the in2[3:0] pins.

Alternatively, you can type the following command in the Tcl Console:

```
select_objects [get_pins my_mult_0/in2[*]]
```

11. Click the **Disconnect Net** button in the Edit section of the Vivado ECO Navigator. The net is disconnected from the pins in the schematic.

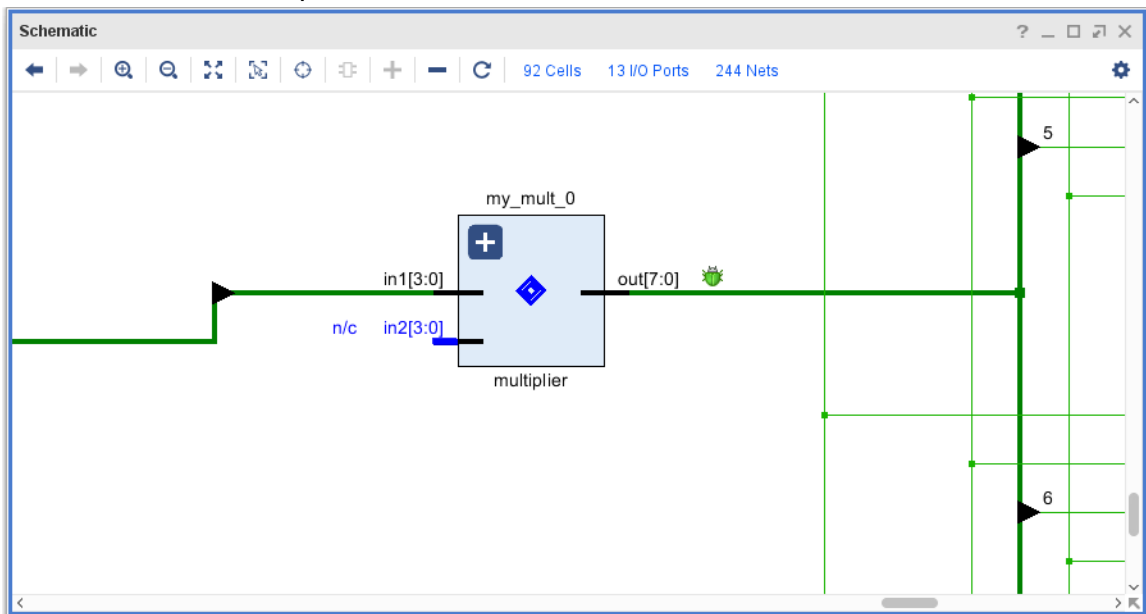

The Tcl Console reproduces the `disconnect_net` command that you just executed in the ECO Navigator. This is useful if you want to replay your ECO changes later by opening the original checkpoint and sourcing a Tcl script with the ECO commands.

```

Tcl Console
mark_objects -color blue [get_cells my_mult_0]
startgroup
disconnect_net -objects [list {my_mult_0/in2[3]}]
disconnect_net -objects [list {my_mult_0/in2[2]}]
disconnect_net -objects [list {my_mult_0/in2[1]}]
disconnect_net -objects [list {my_mult_0/in2[0]}]
endgroup
|
Type a Tcl command here
    
```

The Scratch Pad is populated with the four nets `divClk_reg[28:25]` that you disconnected and the multiplier input pins `my_mult_0/in2[3:0]`. Note the following in the Scratch Pad:

- The Scratch Pad connectivity column (Con) shows a check mark next to the `divClk_reg[28:25]` nets, indicating that they are still connected to the other multiplier inputs.
- The `my_mult_0/in2[3:0]` pins do not show a check mark next to them because they no longer have nets connected.
- The Place and Route (PnR) column is unchecked for everything, indicating that the changes have not yet been implemented on the device.

Con	PnR	Object Name
		my_mult_0/in2
		my_mult_0/in2[3]
		my_mult_0/in2[2]
		my_mult_0/in2[1]
		my_mult_0/in2[0]
✓		divClk_reg
✓		divClk_reg[25]
✓		divClk_reg[26]
✓		divClk_reg[27]
✓		divClk_reg[28]

12. In the Scratch Pad, select the `my_mult_0/in2[3]`, `my_mult_0/in2[2]`, and `my_mult_0/in2[0]` pins.

13. In the Edit section of the Vivado ECO Navigator, click **Connect Net**.

The Connect Net dialog box opens.

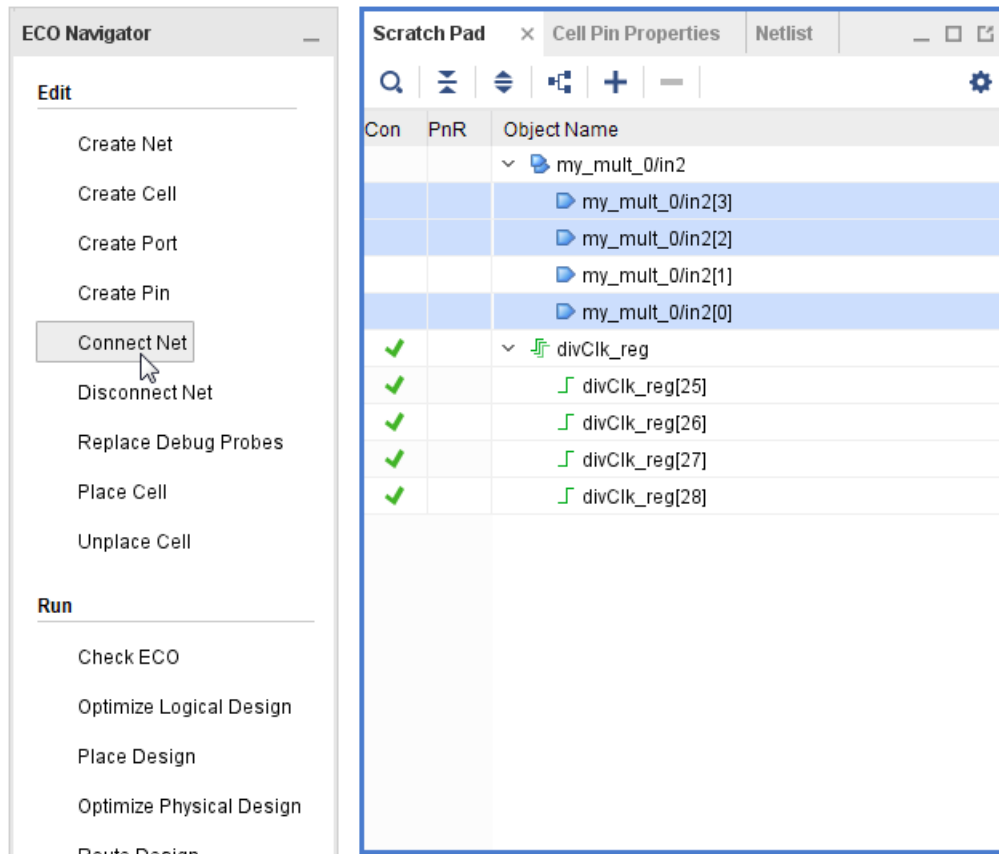

14. In the Connect Net dialog box, select <const0> from the GROUND section.

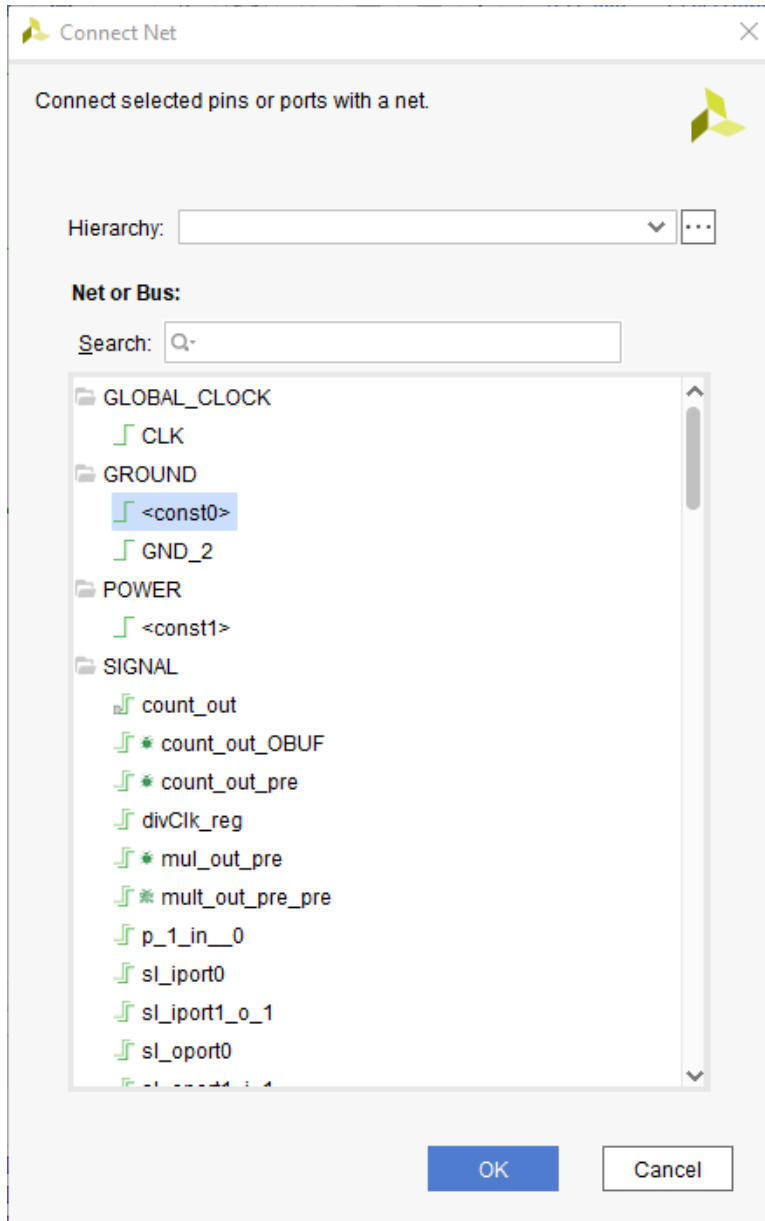

15. Click **OK**.

<const0> is added to the Scratch Pad.

16. Collapse the <const0> signal.

The three pins that you connected now show check marks in the Connectivity column of the Scratch Pad.

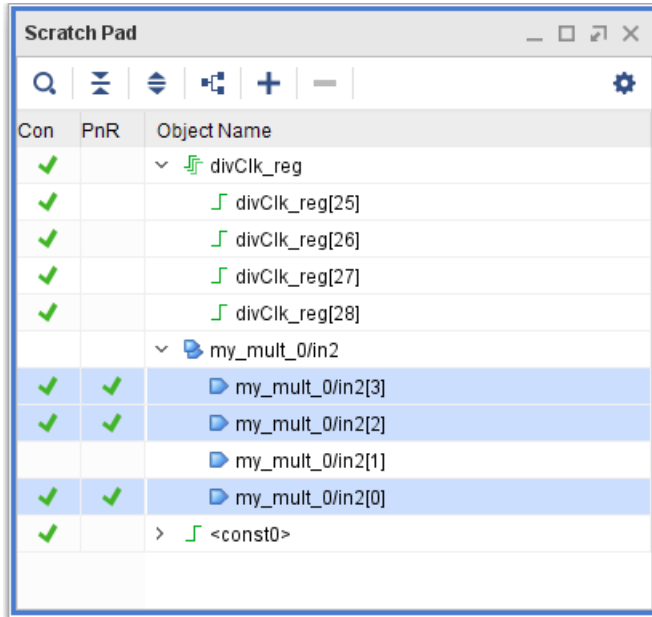

17. In the Scratch Pad, select the **my_mult_0/in2[1]** pin.

18. Click **Connect Net**.

The Connect Net dialog box opens.

19. In the Connect Net dialog box, select **<const1>** from the POWER section.

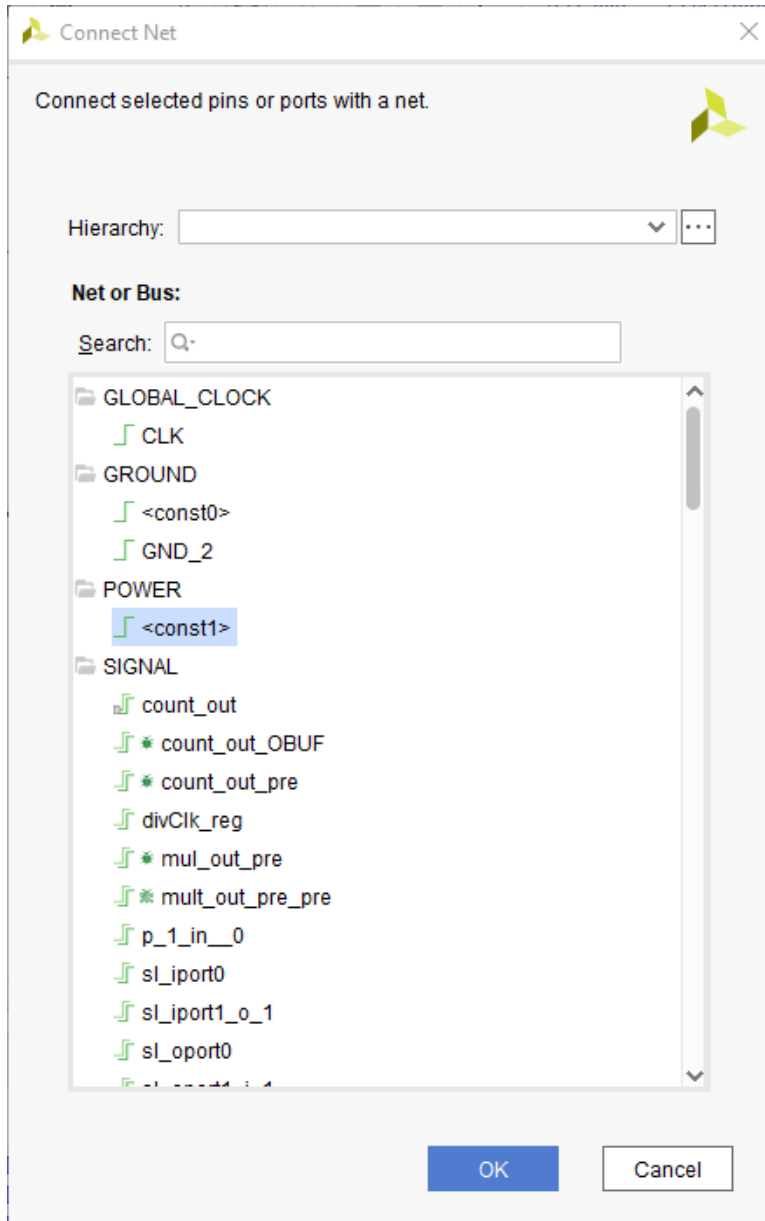

20. Click **OK**.

<const1> is added to the Scratch Pad.

21. Collapse the <const1> signal.

The pin that you connected now shows check marks in the Connectivity column of the Scratch Pad.

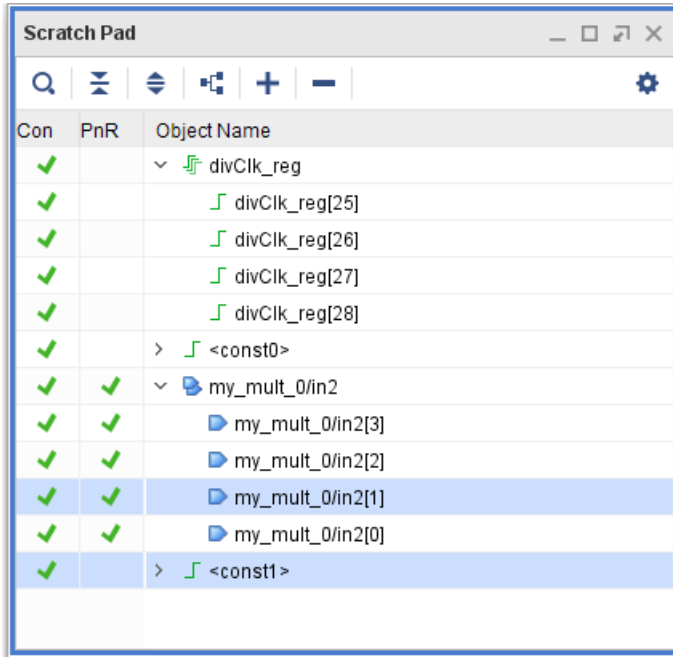

22. Select the `my_mult_0/in2` pin in the Scratch Pad.

This command highlights the pins in the currently open Schematic window, and shows the updated connections.

Note: Make sure that the Autofit Selection  toggle button is highlighted in the Schematic window so you can see the entire path, as shown in the following figure.

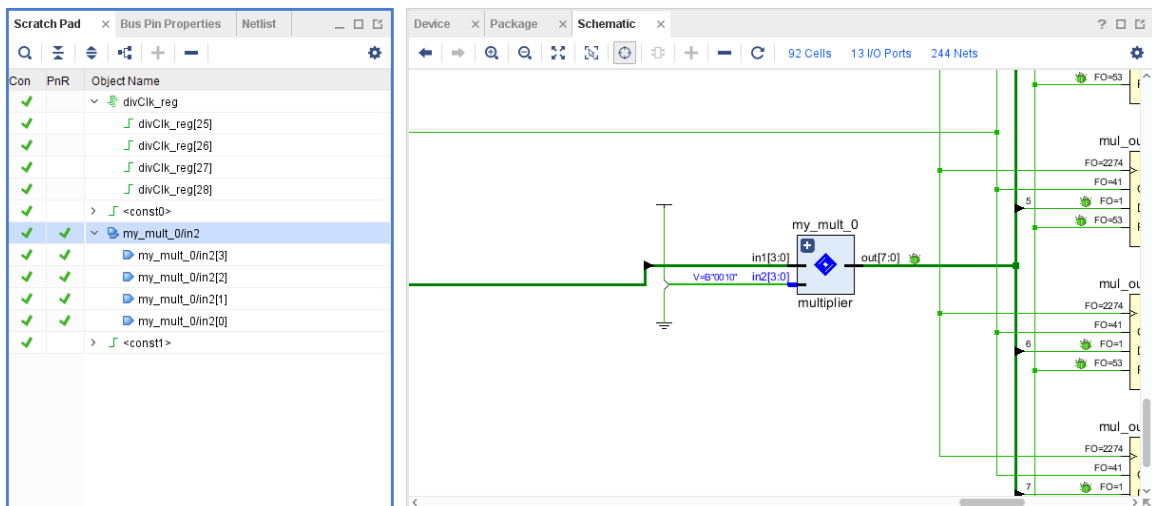

When you observe the count signal on the LEDs, you only use four bits. The upper four bits are padded with zeroes.

Now, you will use the ECO flow to observe counter bit 24 on LED 7. The first step is to analyze the logic that drives `count_out_reg[3]`.

23. From the Tcl Console, type the following command:

```
select_objects [get_cells count_out[3]_i_1]
```

This lets you quickly identify the LUT3 that drives the `count_out_reg[3]` register, which drives LED 3. The inputs are:

- `mul_out_pre_reg[3]` for pin I0
- `count_out_pre_reg[3]` for pin I1
- `tog_state_reg` for pin I2

24. Click the **Cell Properties** tab to view the cell properties and select the **Truth Table** tab.

25. Click **Edit LUT Equation** to view the equation for the LUT3. Note the LUT equation:

$$O = I1 \& !I2 + I0 \& I2$$

26. Click **Cancel** to close the window.

The screenshot shows the Vivado interface. On the left, the 'Cell Properties' window is open for the cell 'count_out[3]_i_1'. The 'Truth Table' tab is selected, showing a truth table with three inputs (I2, I1, I0) and one output (O). The equation for the LUT is $O = I1 \& !I2 + I0 \& I2$. Below the truth table is an 'Edit LUT Equation...' button. On the right, the 'Schematic' view shows the circuit implementation. The LUT3 cell is highlighted in blue, and its output is connected to the 'count_out_reg[3]' register. The schematic also shows other LUTs and registers in the design.

27. From the Tcl Console, type the following command:

```
select_objects [get_cells count_out[7]_i_1]
```

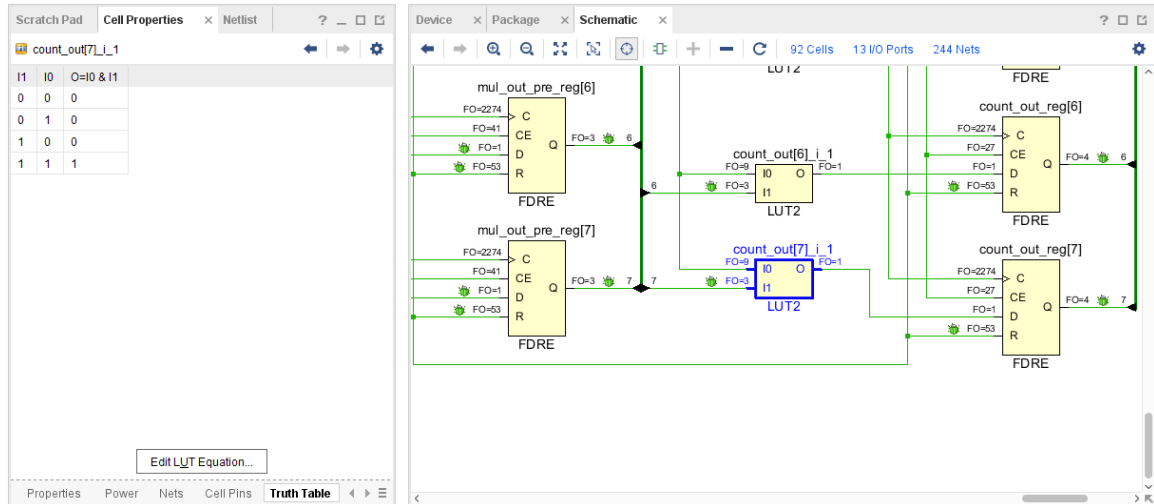

This command selects the LUT2 that drives the `count_out_reg[7]` register, which drives LED 7 on the KCU105 board. The only inputs are `tog_state_reg` for pin I0 and `mul_out_pre_reg[7]` for pin I1. You need to replace the LUT2 with a 3-input LUT and connect the output of counter register `divClk_reg[24]` to the additional input pin.

28. In the Vivado ECO Navigator, under Edit, click **Create Cell**.

The Create Cell dialog box opens.

- In the Cell name field, enter `ECO_LUT3`.
- In the Search field, enter `LUT3`.
- Select **LUT3** as the cell type and copy the LUT equation $O=I1 \& !I2 + I0 \& I2$ from cell `count_out[3]_i_1`.
- Click **OK**.

`ECO_LUT3` is added to the Scratch Pad and the schematic.

- Right-click the newly added `ECO_LUT3` cell in the Scratch Pad, then select **Mark** and the color red.

Note: Marking the `ECO_LUT3` cell makes it easier to locate.

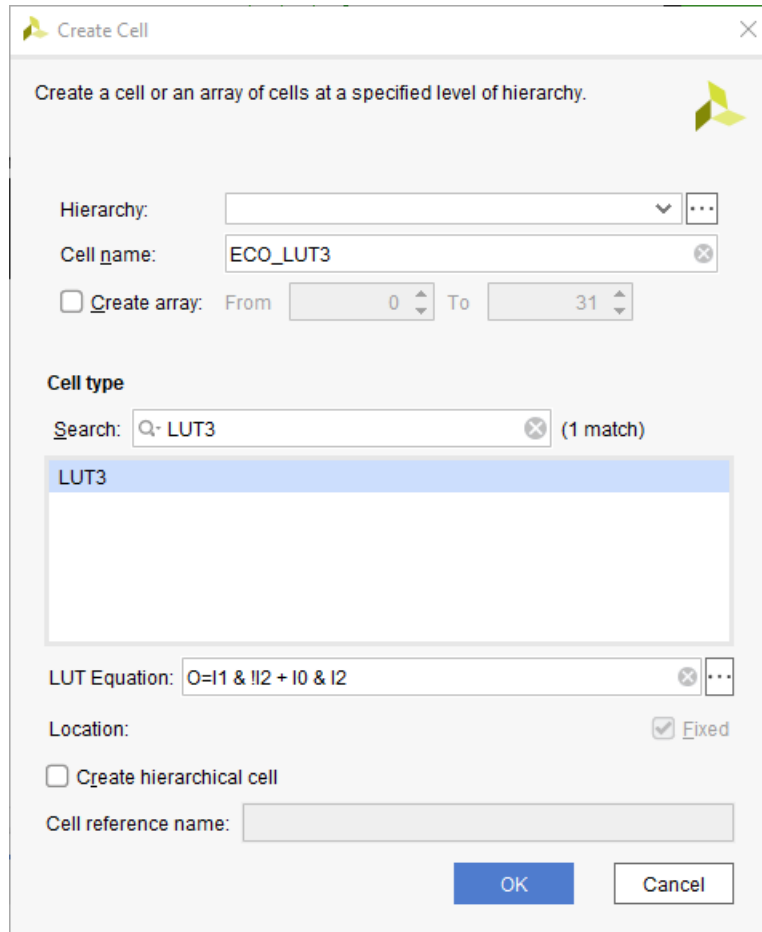

Because you copied the LUT equation from cell `count_out[3]_i_1`, the nets must be hooked up in the same order, with the following connections:

- Net `mul_out_pre[7]` connected to pin `I0`
- Net `divClk_reg_n_0_[24]` connected to pin `I1`
- Net `tog_state` connected to pin `I2` of `ECO_LUT3`

29. Locate the `tog_state` net driven by the `tog_state_reg` register in the schematic and select it. Alternatively you can select the net from the Tcl Console by running the following command:

```
select_objects [get_nets tog_state]
```

30. Connect the `I2` pin of the newly added `ECO_LUT3` cell by doing the following:

- Hold down the **Ctrl** key and select pin **I2** in the Scratch Pad. This selects pin `I2` in addition to the already selected `tog_state` net.
- Click **Connect Net**.

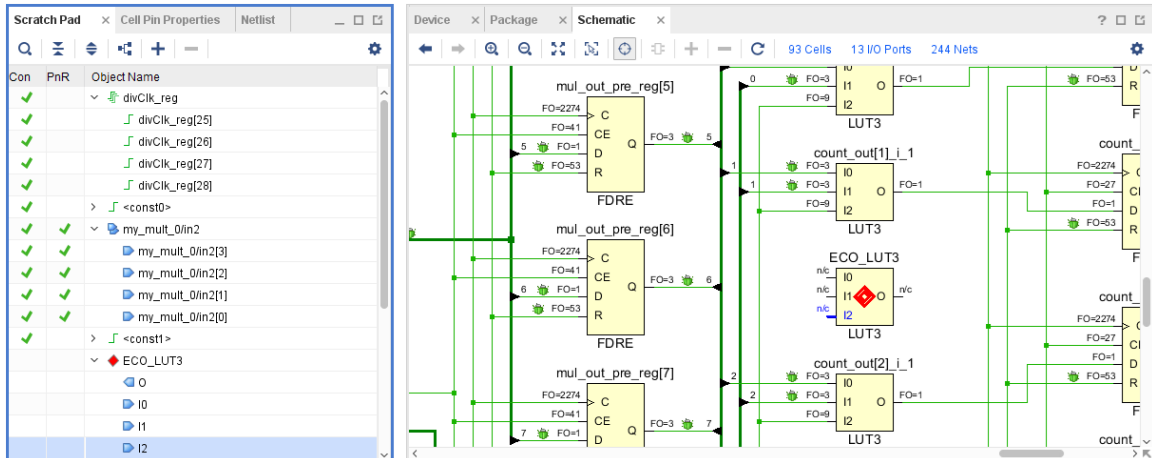

31. Locate the `mul_out_pre[7]` net in the schematic and select it.

Alternatively, you can select the net from the Tcl Console by executing the following command:

```
select_objects [get_nets mul_out_pre[7]]
```

32. Connect the I0 pin of the newly added ECO_LUT3 cell by doing the following:

- Hold down the **CTRL** key and select pin **I0** in the Scratch Pad. This selects pin I0 in addition to the already selected `mul_out_pre[7]` net.
- Click **Connect Net**.

33. Locate the `divClk_reg_n_0[24]` net in the schematic and select it.

Alternatively, you can select the net from the Tcl Console by executing the following command:

```
select_objects [get_nets divClk_reg_n_0[24]]
```

34. Connect the I1 pin of the newly added ECO_LUT3 cell by doing the following:

- Hold down the **CTRL** key and select pin **I1** from the Scratch Pad. This selects pin I1 in addition to the already selected `divClk_reg_n_0[24]` net.
- Click **Connect Net**.

Next, you need to connect the updated logic function implemented in the newly created LUT3 to the D input of `count_out_reg[7]`. The first step is to delete the LUT2 that was previously connected to the D input.

35. Select the **LUT2** `count_out[7]_i_1` in the schematic window.

Alternately, you can select it by executing the following command in the Tcl Console:

```
select_objects [get_cell count_out[7]_i_1]
```

36. In the main toolbar, click the Delete button to delete the selected cell.

37. Select the net connected to the D input of the `count_out_reg[7]` register in the schematic window.

Alternatively you can select the net from the Tcl Console by executing the following command:

```
select_objects [get_nets count_out[7]-i-1-n-0]
```

38. Connect the O pin of the newly added `ECO_LUT3` cell by doing the following:
 - a. Hold down the **CTRL** key and select pin O from the Scratch Pad.
 - b. Click **Connect Net**.

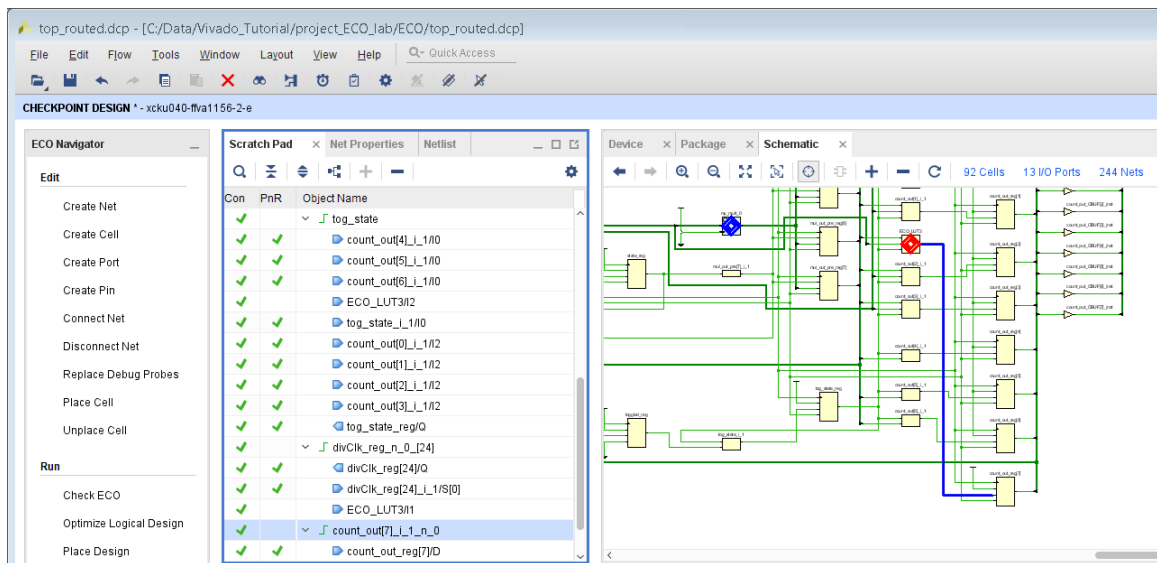

The ECO modifications are complete.

Step 5: Implementing the ECO Changes

Before you place and route the updates, you need to check for any illegal logical connections or other logical issues introduced during the ECO that would prevent a successful implementation of your changes.

1. In the Vivado ECO Navigator, under Run, click **Check ECO**.

The following figure shows the messages generated by the ECO DRC.

- The two Critical Warnings are due to the partially routed signals that are a result of the ECO and will be cleaned up during incremental place and route.
- The Warning message is due to nets in the debug hub instance that do not drive any loads. This Warning can be ignored.
- No other warnings were issued and you are ready to implement the changes.

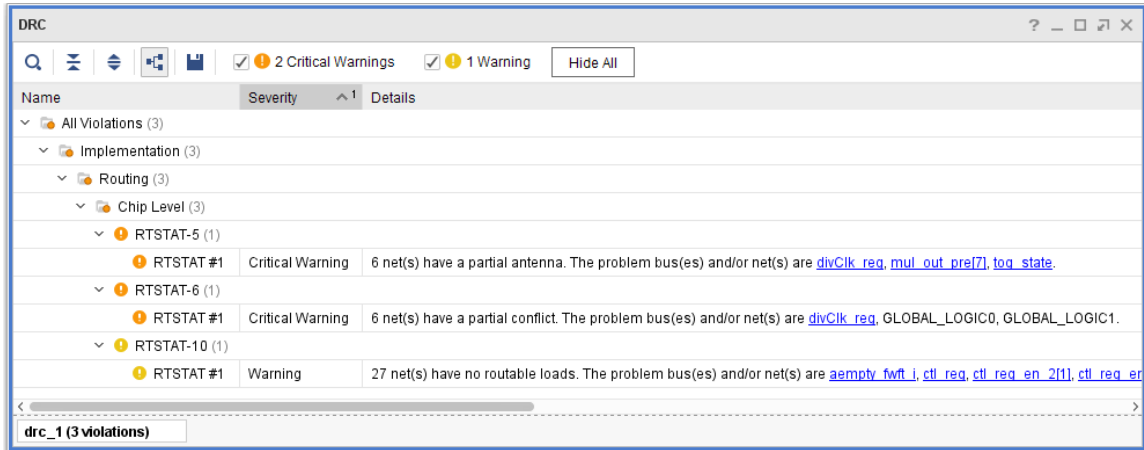

Because you added additional logic, you need to place the logic using the incremental place, and then route the updated net connections using incremental route.

2. In the Vivado ECO Navigator, under Run, click **Place Design**.

The Place Design dialog box opens, allowing you to specify additional options for the `place_design` command. For this exercise, do not specify additional options.

3. Click **OK**.

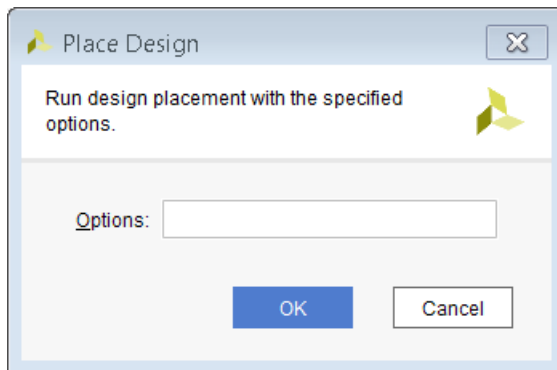

4. Vivado runs the incremental placer.

At the end of the `place_design` step, the incremental Placement Summary is displayed in the Tcl Console.

```

+-----+
| Incremental Placement Summary |
+-----+
|           Type           | Count | Percentage |
+-----+
| Total instances         | 4880 | 100.00 |
| Reused instances       | 4878 | 99.96 |
| Non-reused instances   | 2 | 0.04 |
|   New                  | 1 | 0.02 |
|   Discarded illegal placement due to netlist changes | 1 | 0.02 |
+-----+
| Incremental Placement Runtime Summary |
+-----+
| Initialization time (elapsed secs) | 4.08 |
| Incremental Placer time (elapsed secs) | 7.29 |
+-----+
    
```

The incremental placement summary shows that the following two cells did not have their previous placement reused:

- The new `ECO_LUT3` cell, which had to be placed from scratch
- The `count_out_reg[7]` cell, which had to get updated placement due to the placement of the `ECO_LUT3` driving it

5. In the Vivado ECO Navigator, under Run, click **Route Design**.

The Route Design dialog box opens.

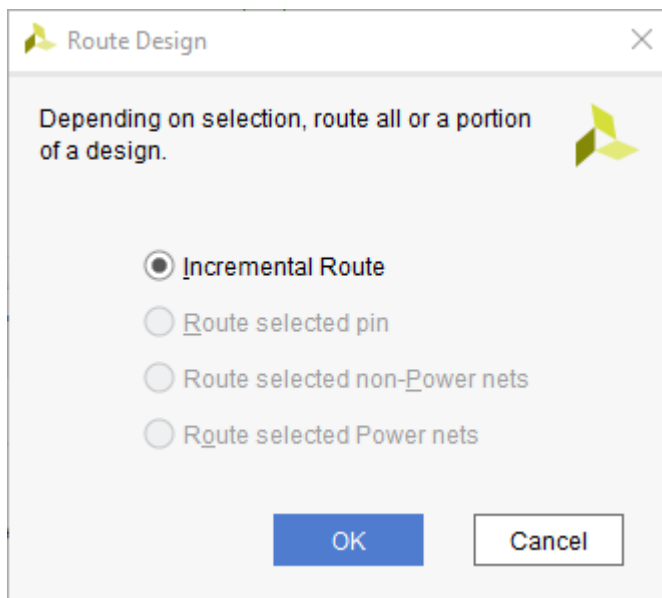

Depending on your selection, you have four options to route the ECO changes:

- **Incremental Route:** This is the default option.
- **Route selected pin:** This option limits the route operation to the selected pin.

- **Route selected non-Power nets:** This option routes only the selected signal nets.
- **Route selected Power nets:** This option routes only the selected VCC/GND nets.

In this case, the best choice is to route the changes you made incrementally.

6. Select **Incremental Route**.
7. Click **OK**.

At the end of the `route_design` step, the incremental Routing Reuse Summary displays in the Tcl Console.

```

-----
|Incremental Routing Reuse Summary          |
-----
|Type                | Count  | Percentage |
-----
|Fully reused nets   |    3761|    99.89  |
|Partially reused nets |     3  |     0.08  |
|Non-reused nets     |     1  |     0.03  |
-----
    
```

Most of the nets did not require any routing and have been fully reused.



TIP: It is a good idea to run `report_route_status` after the route operation to make sure all the nets have been routed and none have any routing issues. This is especially true if you only routed selected pins or selected nets and want to make sure you have not missed any routes.

8. In the Tcl Console, run the `report_route_status` command.

The Design Route Status looks similar to the following status.

```

Design Route Status
                                     :    # nets :
----- : ----- :
# of logical nets..... :    5160 :
  # of nets not needing routing..... :    1363 :
    # of internally routed nets..... :    1306 :
      # of nets with no loads..... :     57 :
# of routable nets..... :    3797 :
  # of fully routed nets..... :    3797 :
    # of nets with routing errors..... :     0 :
----- : ----- :
    
```

Before you generate a bitstream, run the ECO DRCs on the design.

9. In the ECO Navigator, click **Check ECO**. Make sure no Critical Warnings are generated.



10. In the Vivado ECO Navigator, under Program, click **Save Checkpoint As**.

The Save Checkpoint As dialog box opens and you can specify a name for the checkpoint file to write to disk.

11. Click **OK** to save a checkpoint file with your changes.

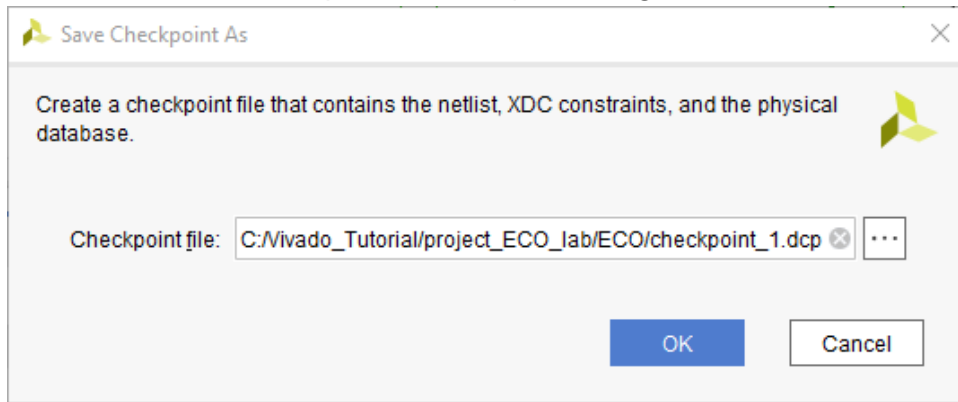

12. In the Vivado ECO Navigator, under Program, click **Generate Bitstream**.

The Generate Bitstream dialog box opens.

You can specify a name for a Bit file and select the desired options for the `write_bitstream` operation.

13. Click **OK** to generate a bitstream with your changes.

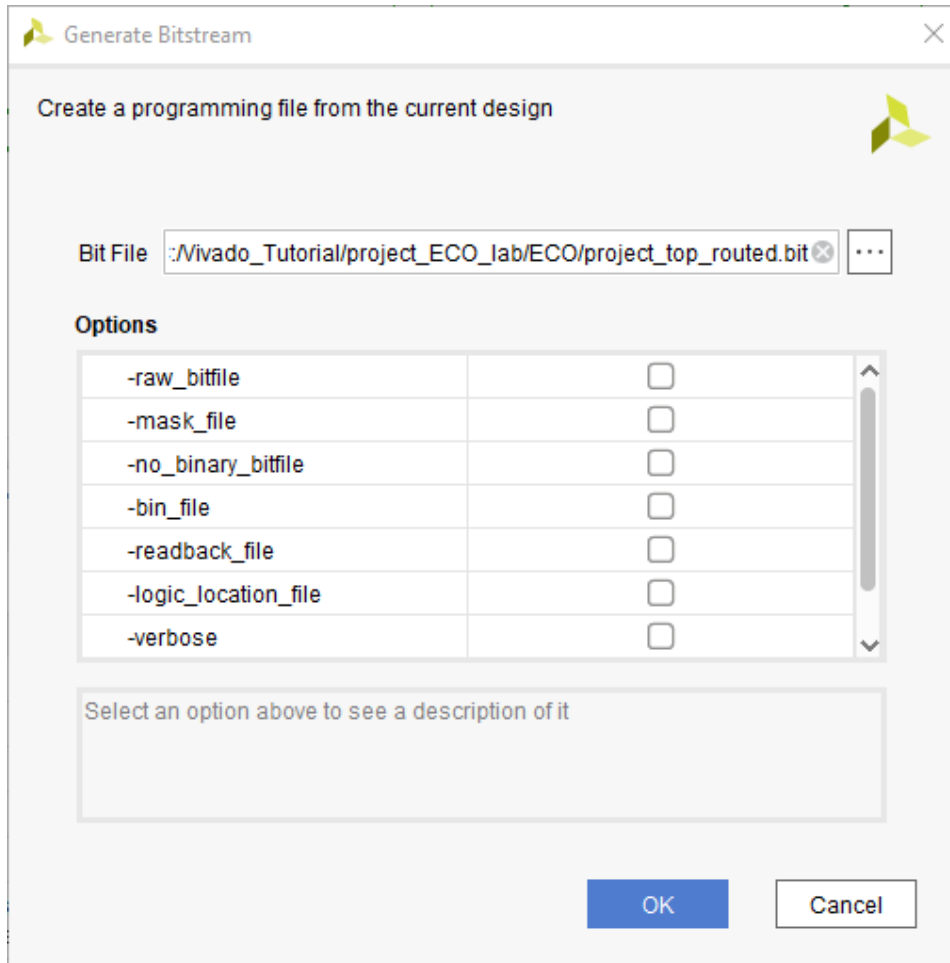

14. In the Vivado ECO Navigator, under Program, click **Write Debug Probes**.
The Write Debug Probes dialog box opens.

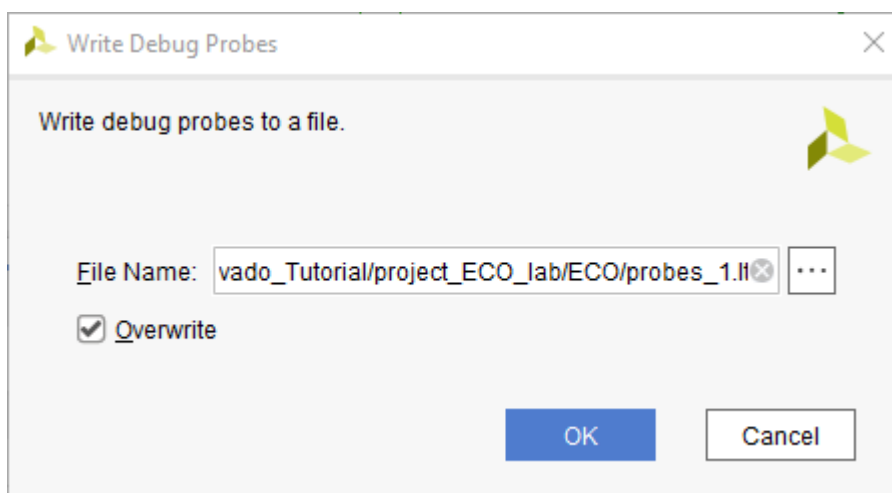

You can specify a name for a .1tx file for your debug probes.

- Click **OK** to generate debug probes file (LTX).

This command allows you to generate a new `.ltx` file for your debug probes. If you made changes to your debug probes using the Replace Debug Probes command, you need to save the updated information to a new debug probes file to reflect the changes in the Vivado Hardware Manager.

- Follow the instructions in Step 3: Validating the Design on the Board to download the generated bitstream programming file and debug probes file into the target FPGA device using the Hardware Manager to check your ECO modifications.

Step 6: Replacing Debug Probes

Another powerful feature of the Vivado ECO flow is the ability to replace debug probes on a previously inserted Debug Hub. After the debug probes have been replaced, a new LTX file can be generated that contains the updated debug probe information.

To replace a debug probe in your previously modified design, do the following:

- From the main menu, select **File** → **Checkpoint** → **Open**.

The Open Checkpoint dialog box opens.

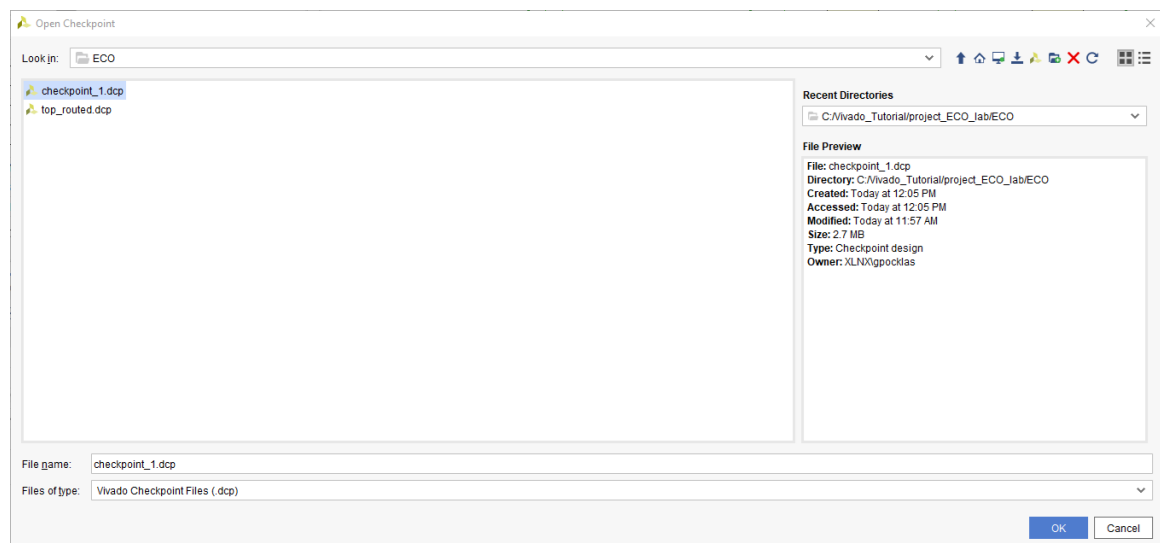

- Browse to the `C:/Data/Vivado_Tutorial/project_ECO_lab/ECO` directory and select the previously saved `checkpoint_1.dcp` file.
- Close any previously open checkpoints.
- From the main menu, select **Layout** → **ECO**.
- In the Vivado ECO Navigator, under Edit, click Replace Debug Probes.

The Replace Debug Probes dialog box opens.

In this example, you will replace the net `reset_vio` that is connected to `probe4` of `u_ila_0` with the net `toggle_vio`.

6. Scroll to the bottom of the probes for `u_ila_0` in the Replace Debug Probes dialog and click the `reset_vio` net name in the Probe column to select it.
7. Click the Edit Probes button .

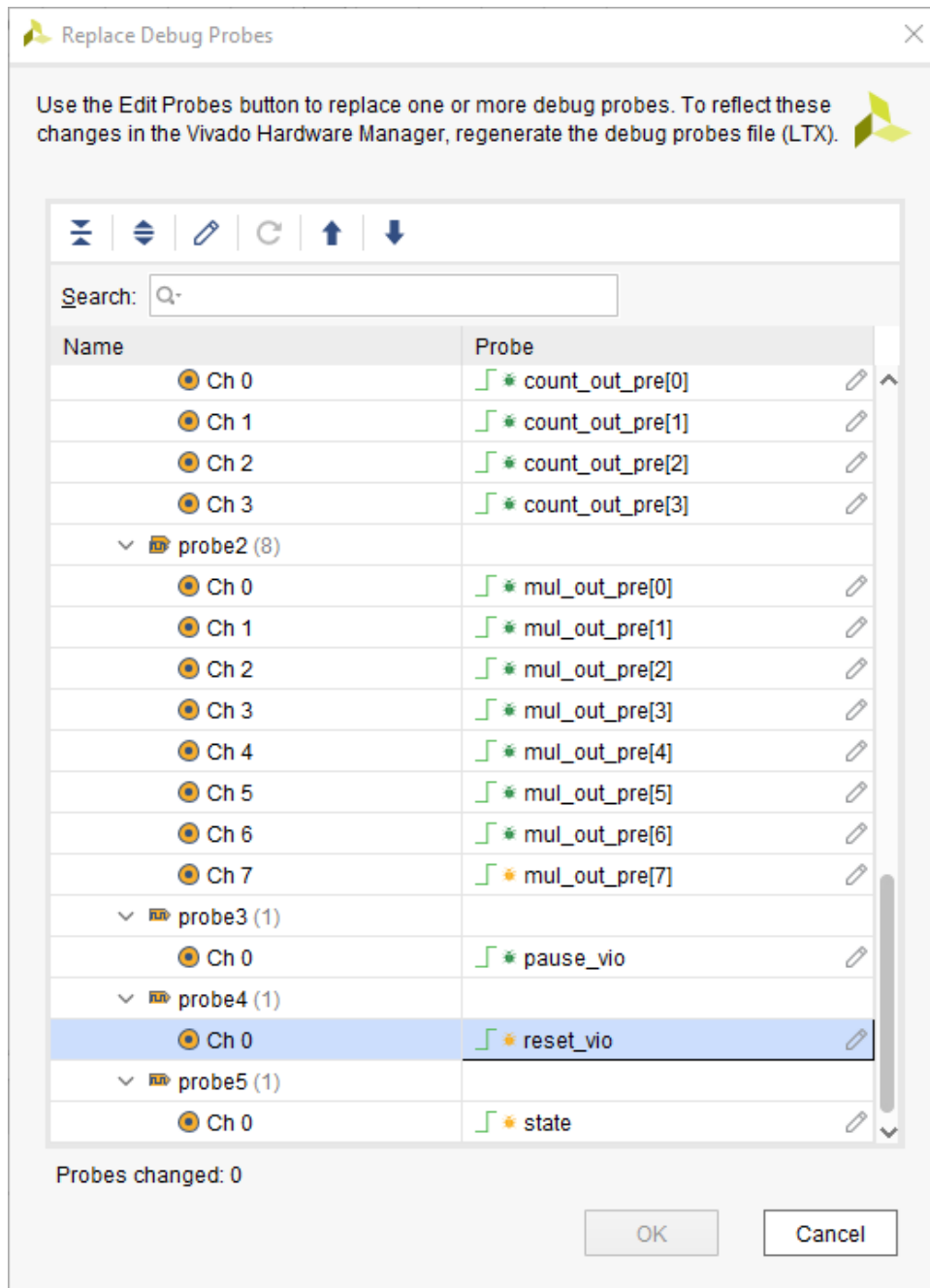

The Choose Nets dialog box opens.

8. Choose a new net to connect to the debug probe `probe4` by doing the following:

- a. Type `toggle_vio` in the search field of the Choose Nets dialog box.
- b. Click **Find**.
- c. Select the `toggle_vio` net, and move it to the Selected names section.
- d. Click **OK**.

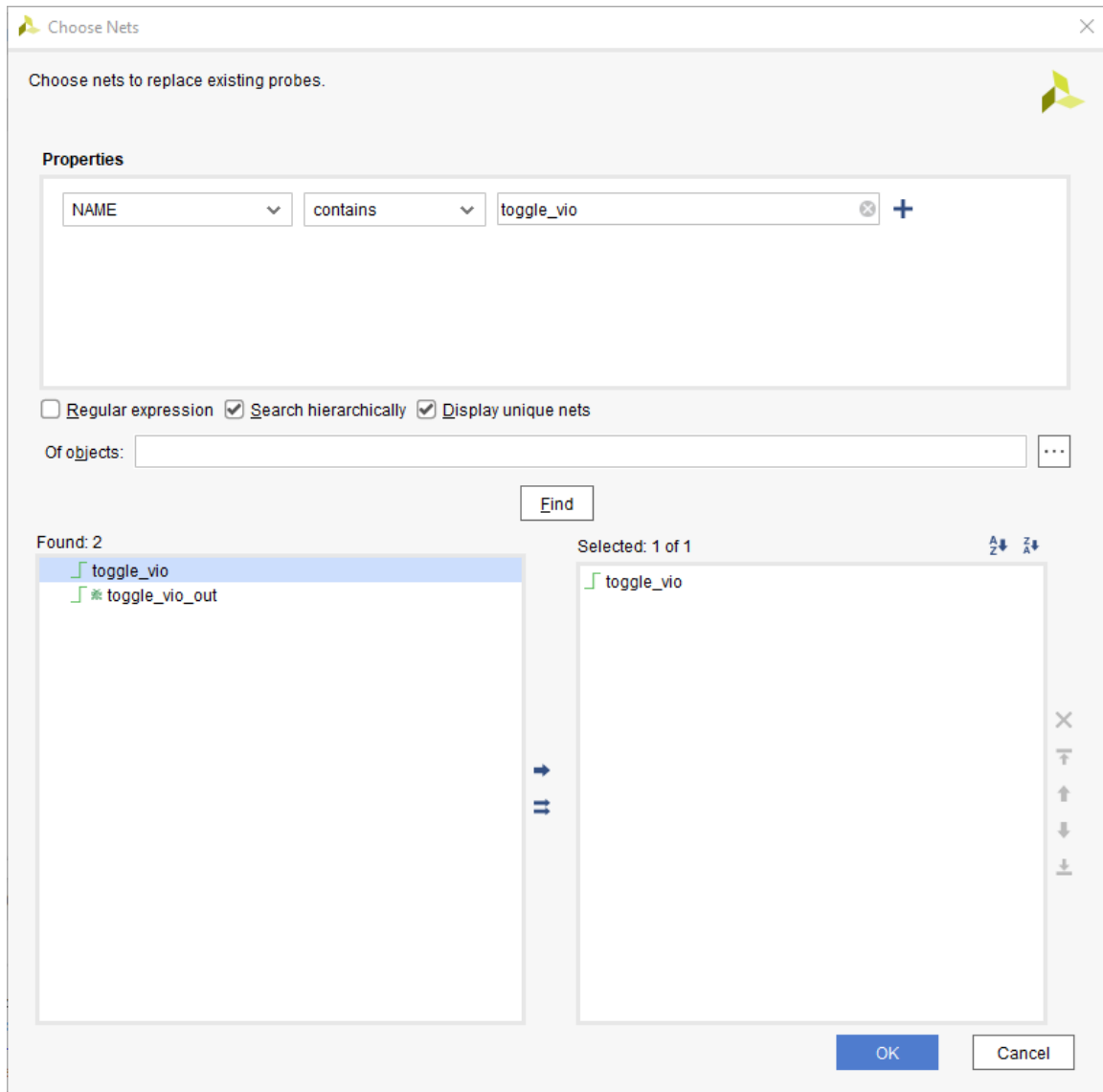

9. In the Replace Debug Probes dialog box, click **OK**.
10. Repeat steps 5 through 14 of Step 5: Implementing the ECO Changes to generate an updated design checkpoint, bitstream file, and probes file (LTX).

The updated debug probes file has the `reset_vio` net for `probe4` replaced with net `toggle_vio`, which you can verify when you program the device with the updated bit file and debug probes file.

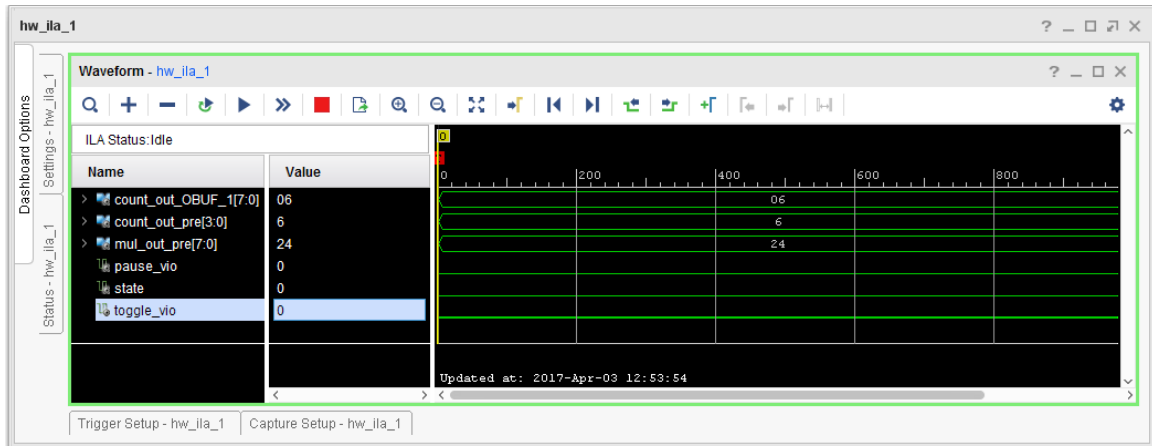

Related Information

[Step 5: Implementing the ECO Changes](#)

Conclusion

In this lab you learned the following:

- Made changes to the previously implemented design using the Vivado ECO flow.
- Implemented the changes using incremental place and route.
- Generated a bitstream and probes file with your changes to configure the FPGA.
- Used the Replace Debug Probes command to switch the sources for debug probes in the design.

Additional Resources and Legal Notices

Please Read: Important Legal Notices

The information disclosed to you hereunder (the "Materials") is provided solely for the selection and use of Xilinx products. To the maximum extent permitted by applicable law: (1) Materials are made available "AS IS" and with all faults, Xilinx hereby **DISCLAIMS ALL WARRANTIES AND CONDITIONS, EXPRESS, IMPLIED, OR STATUTORY, INCLUDING BUT NOT LIMITED TO WARRANTIES OF MERCHANTABILITY, NON-INFRINGEMENT, OR FITNESS FOR ANY PARTICULAR PURPOSE**; and (2) Xilinx shall not be liable (whether in contract or tort, including negligence, or under any other theory of liability) for any loss or damage of any kind or nature related to, arising under, or in connection with, the Materials (including your use of the Materials), including for any direct, indirect, special, incidental, or consequential loss or damage (including loss of data, profits, goodwill, or any type of loss or damage suffered as a result of any action brought by a third party) even if such damage or loss was reasonably foreseeable or Xilinx had been advised of the possibility of the same. Xilinx assumes no obligation to correct any errors contained in the Materials or to notify you of updates to the Materials or to product specifications. You may not reproduce, modify, distribute, or publicly display the Materials without prior written consent. Certain products are subject to the terms and conditions of Xilinx's limited warranty, please refer to Xilinx's Terms of Sale which can be viewed at <https://www.xilinx.com/legal.htm#tos>; IP cores may be subject to warranty and support terms contained in a license issued to you by Xilinx. Xilinx products are not designed or intended to be fail-safe or for use in any application requiring fail-safe performance; you assume sole risk and liability for use of Xilinx products in such critical applications, please refer to Xilinx's Terms of Sale which can be viewed at <https://www.xilinx.com/legal.htm#tos>.

AUTOMOTIVE APPLICATIONS DISCLAIMER

AUTOMOTIVE PRODUCTS (IDENTIFIED AS "XA" IN THE PART NUMBER) ARE NOT WARRANTED FOR USE IN THE DEPLOYMENT OF AIRBAGS OR FOR USE IN APPLICATIONS THAT AFFECT CONTROL OF A VEHICLE ("SAFETY APPLICATION") UNLESS THERE IS A SAFETY CONCEPT OR REDUNDANCY FEATURE CONSISTENT WITH THE ISO 26262 AUTOMOTIVE SAFETY STANDARD ("SAFETY DESIGN"). CUSTOMER SHALL, PRIOR TO USING

OR DISTRIBUTING ANY SYSTEMS THAT INCORPORATE PRODUCTS, THOROUGHLY TEST SUCH SYSTEMS FOR SAFETY PURPOSES. USE OF PRODUCTS IN A SAFETY APPLICATION WITHOUT A SAFETY DESIGN IS FULLY AT THE RISK OF CUSTOMER, SUBJECT ONLY TO APPLICABLE LAWS AND REGULATIONS GOVERNING LIMITATIONS ON PRODUCT LIABILITY.

Copyright

© Copyright 2012-2021 Xilinx, Inc. Xilinx, the Xilinx logo, Alveo, Artix, Kintex, Spartan, Versal, Virtex, Vivado, Zynq, and other designated brands included herein are trademarks of Xilinx in the United States and other countries. All other trademarks are the property of their respective owners.