

Vivado Design Suite Reference Guide

Model-Based DSP Design Using System Generator

UG958 (v2020.2) November 18, 2020

Revision History

The following table shows the revision history for this document.

Section	Revision Summary
11/18/2020 Version 2020.2	
Xilinx Blockset	<ul style="list-style-type: none"> • Clarification to DSPCPLX. • Clarification to FIFO. • Added DSP Macro 1.0. This replaces the deprecated DSP48 Macro 3.0. • Added DSP58. • Added Vitis HLS.
Xilinx SSR Blockset	Clarification to Vector DDFS .
Chapter 4: System Generator Utilities	Clarification to xITBUtils .
06/03/2020 Version 2020.1	
Xilinx Blockset	Clarifications to the following blocks: <ul style="list-style-type: none"> • Single-Port RAM • ROM • Dual-Port RAM • AXI FIFO
Throughout document	Editorial updates.

Table of Contents

Revision History	2
Navigating Content by Design Process	8
Chapter 1: Xilinx Blockset	9
Organization of Blockset Libraries.....	9
Common Options in Block Parameter Dialog Boxes.....	26
Block Reference Pages.....	29
Absolute.....	30
Accumulator.....	31
Addressable Shift Register.....	33
AddSub.....	35
Assert.....	37
AXI FIFO.....	40
BitBasher.....	42
Black Box.....	45
CIC Compiler 4.0.....	53
Clock Enable Probe.....	56
Clock Probe.....	58
CMult.....	59
Complex Multiplier 6.0.....	61
Concat.....	64
Constant.....	65
Convert.....	67
Convolution Encoder 9.0.....	70
CORDIC 6.0.....	73
Counter.....	78
DDS Compiler 6.0.....	81
Delay.....	88
Depuncture.....	94
Digital FIR Filter.....	96
Divide.....	99
Divider Generator 5.1.....	102

Down Sample.....	105
DSP48E.....	107
DSP Macro 1.0.....	113
DSP48E1.....	115
DSP48E2.....	122
DSP58.....	129
DSPCPLX.....	136
Dual Port RAM.....	144
Exponential.....	148
Expression.....	150
Fast Fourier Transform 9.1.....	151
FDATool.....	157
FFT.....	158
FIFO.....	162
FIR Compiler 7.2.....	165
Gateway In.....	173
Gateway Out.....	177
Indeterminate Probe.....	180
Interleaver/De-interleaver 8.0.....	180
Inverse FFT.....	191
Inverter.....	195
LFSR.....	196
Logical.....	198
MCode.....	199
ModelSim.....	225
Mult.....	231
MultAdd.....	233
Mux.....	235
Natural Logarithm.....	236
Negate.....	238
Opmode.....	239
Parallel to Serial.....	252
Product.....	253
Puncture.....	254
Reciprocal.....	255
Reciprocal SquareRoot.....	257
Reed-Solomon Decoder 9.0.....	258
Reed-Solomon Encoder 9.0.....	265

Register.....	271
Reinterpret.....	272
Relational.....	273
Requantize.....	274
Reset Generator.....	276
ROM.....	277
Sample Time.....	279
Scale.....	280
Serial to Parallel.....	281
Shift.....	282
Sine Wave.....	283
Single Port RAM.....	287
Slice.....	292
SquareRoot.....	293
System Generator.....	294
Threshold.....	300
Time Division Demultiplexer.....	301
Time Division Multiplexer.....	302
Toolbar.....	303
Up Sample.....	306
Viterbi Decoder 9.1.....	308
Vitis HLS.....	314
Chapter 2: Xilinx SSR Blockset.....	317
Scalar2Vector.....	317
Vector Absolute.....	318
Vector AddSub Fabric.....	319
Vector Assert.....	321
Vector Complex Mult.....	323
Vector Concat.....	324
Vector Constant.....	325
Vector Convert.....	326
Vector DDFS.....	329
Vector Delay.....	330
Vector Delay Delta.....	333
Vector Down Sample.....	333
Vector FFT.....	336
Vector FIR.....	338

Vector Logical.....	344
Vector Mux.....	345
Vector Real Gateway In.....	347
Vector Real Gateway Out.....	351
Vector Real Mult.....	354
Vector Register.....	357
Vector Reinterpret.....	358
Vector Relational.....	359
Vector Slice.....	360
Vector Up Sample.....	362
Vector2Scalar.....	364
Chapter 3: Xilinx Reference Blockset.....	365
Organization of Reference Blockset Libraries.....	365
2 Channel Decimate by 2 MAC FIR Filter.....	366
2n+1-tap Linear Phase MAC FIR Filter.....	368
2n-tap Linear Phase MAC FIR Filter.....	369
2n-tap MAC FIR Filter.....	370
4-channel 8-tap Transpose FIR Filter.....	371
4n-tap MAC FIR Filter.....	372
5x5Filter.....	373
BPSK AWGN Channel.....	375
CIC Filter.....	376
Convolutional Encoder.....	378
CORDIC ATAN.....	381
CORDIC DIVIDER.....	382
CORDIC LOG.....	384
CORDIC SINCOS.....	385
CORDIC SQRT.....	387
Dual Port Memory Interpolation MAC FIR Filter.....	389
Interpolation Filter.....	390
m-channel n-tap Transpose FIR Filter.....	391
Mealy State Machine.....	392
Moore State Machine.....	395
n-tap Dual Port Memory MAC FIR Filter.....	399
n-tap MAC FIR Filter.....	400
Registered Mealy State Machine.....	401
Registered Moore State Machine.....	405

Virtex Line Buffer.....	409
Virtex2 Line Buffer.....	410
Virtex2 5 Line Buffer.....	410
White Gaussian Noise Generator.....	411
Chapter 4: System Generator Utilities.....	414
xilinx.analyzer.....	414
xilinx.environment.getcachepath and xilinx.environment.setcachepath.....	426
xilinx.resource_analyzer.....	427
xilinx.utilities.importBD.....	438
xlAddTerms.....	439
xlConfigureSolver.....	442
xlfa_denominator.....	443
xlfa_numerator.....	443
xlGenerateButton.....	444
xlgetparam and xlsetparam.....	444
xlgetparams.....	446
xlGetReOrderedCoeff.....	447
xlOpenWaveFormData.....	448
xlSetUseHDL.....	449
xlTBUtills.....	450
Chapter 5: Programmatic Access.....	454
System Generator API for Programmatic Generation.....	454
PG API Examples.....	460
PG API Error/Warning Handling and Messages.....	467
M-Code Access to Hardware Co-Simulation.....	469
Appendix A: Additional Resources and Legal Notices.....	481
Documentation Navigator and Design Hubs.....	481
References.....	481
Please Read: Important Legal Notices.....	482

Navigating Content by Design Process

Xilinx[®] documentation is organized around a set of standard design processes to help you find relevant content for your current development task. This document covers the following design processes:

- **Hardware, IP, and Platform Development:** Creating the PL IP blocks for the hardware platform, creating PL kernels, subsystem functional simulation, and evaluating the Vivado[®] timing, resource use, and power closure. Also involves developing the hardware platform for system integration.

Xilinx Blockset

Organization of Blockset Libraries

For convenience, this chapter is organized into the following sections.

Organization of Blockset Libraries	Describes how the Xilinx blocks are organized into libraries.
Common Options in Block Parameter Dialog Boxes	Describes block parameters that are common to most blocks in the Xilinx blockset.
Block Reference Pages	Alphabetical listing of the Xilinx blockset with detailed descriptions of each block.

The Xilinx[®] Blockset contains building blocks for constructing DSP and other digital systems in FPGAs using Simulink[®]. The blocks are grouped into libraries according to their function, and some blocks with broad applicability (for example, the Gateway I/O blocks) are linked into multiple libraries. The following libraries are provided:

Library	Description
AXI4 Blocks	Includes every block that supports the AXI4 Interface.
Basic Element Blocks	Includes standard building blocks for digital logic.
Communication Blocks	Includes forward error correction and modulator blocks, commonly used in digital communications systems.
Control Logic Blocks	Includes blocks for control circuitry and state machines.
Data Type Blocks	Includes blocks that convert data types (includes gateways).
DSP Blocks	Includes Digital Signal Processing (DSP) blocks.
Floating-Point Blocks	Includes blocks that support the Floating-Point data type as well as other data types. Only a single data type is supported at a time. For example, a floating-point input produces a floating-point output; a fixed-point input produces a fixed-point output.
Index Blocks	Includes all System Generator blocks.
Math Blocks	Includes blocks that implement mathematical functions.
Memory Blocks	Includes blocks that implement and access memories.
Tool Blocks	Includes “Utility” blocks, e.g. code generation (System Generator token), resource estimation, HDL co-simulation, etc.

Each block has a background color that indicates the following:

Background Color	Meaning
Blue	Block goes into the FPGA fabric and is free!
Green	Block goes into the FPGA fabric and is a Licensed Core. Go to the Xilinx web site to purchase the Core license.
Yellow	Blocks on the boundary of your design like Gateway, Shared Memory Read, Shared Memory Write, VDMA, etc.
White	Utility or Tool
Red Symbol	System Generator token (control panel).

AXI4 Blocks

Table 1: AXI4 Blocks

AXI4 Block	Description
AXI FIFO	The Xilinx® AXI FIFO block implements a FIFO memory queue with an AXI-compatible block interface.
CIC Compiler 4.0	The Xilinx CIC Compiler provides the ability to design and implement AXI4-Streamcompliant Cascaded Integrator-Comb (CIC) filters for a variety of Xilinx FPGA devices.
Complex Multiplier 6.0	The Complex Multiplier block implements AXI4-Stream compliant, high-performance, optimized complex multipliers for devices based on user-specified options.
Convolution Encoder 9.0	The Xilinx Convolution Encoder block implements an encoder for convolution codes. Ordinarily used in tandem with a Viterbi decoder, this block performs forward error correction (FEC) in digital communication systems. This block adheres to the AMBA® AXI4-Stream standard.
CORDIC 6.0	The Xilinx CORDIC block implements a generalized coordinate rotational digital computer (CORDIC) algorithm and is AXI compliant.
DDS Compiler 6.0	The Xilinx DDS (Direct Digital Synthesizer) Compiler block implements high performance, optimized Phase Generation and Phase to Sinusoid circuits with AXI4-Stream compliant interfaces for supported devices.
Divider Generator 5.1	The Xilinx Divider Generator block creates a circuit for integer division based on Radix-2 non-restoring division, or High-Radix division with prescaling.
Fast Fourier Transform 9.1	The Xilinx Fast Fourier Transform block implements the Cooley-Tukey FFT algorithm, a computationally efficient method for calculating the Discrete Fourier Transform (DFT). In addition, the block provides an AXI4-Stream-compliant interface.
FIR Compiler 7.2	This Xilinx FIR Compiler block provides users with a way to generate highly parameterizable, area-efficient, high-performance FIR filters with an AXI4-Stream-compliant interface.
Interleaver/De-interleaver 8.0	The Xilinx Interleaver Deinterleaver block implements an interleaver or a deinterleaver using an AXI4-compliant block interface. An interleaver is a device that rearranges the order of a sequence of input symbols. The term symbol is used to describe a collection of bits. In some applications, a symbol is a single bit. In others, a symbol is a bus.
Reed-Solomon Decoder 9.0	The Reed-Solomon (RS) codes are block-based error correcting codes with a wide range of applications in digital communications and storage.
Reed-Solomon Encoder 9.0	The Reed-Solomon (RS) codes are block-based error correcting codes with a wide range of applications in digital communications and storage. This block adheres to the AMBA® AXI4-Stream standard.
Viterbi Decoder 9.1	Data encoded with a convolution encoder can be decoded using the Xilinx Viterbi decoder block. This block adheres to the AMBA® AXI4-Stream standard.

Basic Element Blocks

Table 2: Basic Element Blocks

Basic Element Block	Description
Absolute	The Xilinx Absolute block outputs the absolute value of the input.
Addressable Shift Register	The Xilinx Addressable Shift Register block is a variable-length shift register in which any register in the delay chain can be addressed and driven onto the output data port.
Assert	The Xilinx Assert block is used to assert a rate and/or a type on a signal. This block has no cost in hardware and can be used to resolve rates and/or types in situations where designer intervention is required.
BitBasher	The Xilinx BitBasher block performs slicing, concatenation, and augmentation of inputs attached to the block.
Black Box	The System Generator Black Box block provides a way to incorporate hardware description language (HDL) models into System Generator.
Clock Enable Probe	The Xilinx Clock Enable (CE) Probe provides a mechanism for extracting derived clock enable signals from Xilinx signals in System Generator models.
Concat	The Xilinx Concat block performs a concatenation of n bit vectors represented by unsigned integer numbers, for example, n unsigned numbers with binary points at position zero.
Constant	The Xilinx Constant block generates a constant that can be a fixed-point value, a Boolean value, or a DSP48 instruction. This block is similar to the Simulink Simulink® constant block, but can be used to directly drive the inputs on Xilinx blocks.
Convert	The Xilinx Convert block converts each input sample to a number of a desired arithmetic type. For example, a number can be converted to a signed (two's complement), or unsigned value.
Counter	The Xilinx Counter block implements a free-running or count-limited type of an up, down, or up/down counter. The counter output can be specified as a signed or unsigned fixed-point number.
Delay	The Xilinx Delay block implements a fixed delay of L cycles.
Down Sample	The Xilinx Down Sample block reduces the sample rate at the point where the block is placed in your design.
Expression	The Xilinx Expression block performs a bitwise logical expression.
Gateway In	The Xilinx Gateway In blocks are the inputs into the Xilinx portion of your Simulink design. These blocks convert Simulink integer, double, and fixed-point data types into the System Generator fixed-point type. Each block defines a top-level input port or interface in the HDL design generated by System Generator.
Gateway Out	Xilinx Gateway Out blocks are the outputs from the Xilinx portion of your Simulink design. This block converts the System Generator fixed-point or floating-point data type into a Simulink integer, single, double, or fixed-point data type.
Inverter	The Xilinx Inverter block calculates the bitwise logical complement of a fixed-point number. The block is implemented as a synthesizable VHDL module.
LFSR	The Xilinx LFSR block implements a Linear Feedback Shift Register (LFSR). This block supports both the Galois and Fibonacci structures using either the XOR or XNOR gate and allows a re-loadable input to change the current value of the register at any time. The LFSR output and re-loadable input can be configured as either serial or parallel ports.
Logical	The Xilinx Logical block performs bitwise logical operations on fixed-point numbers. Operands are zero padded and sign extended as necessary to make binary point positions coincide; then the logical operation is performed and the result is delivered at the output port.

Table 2: Basic Element Blocks (cont'd)

Basic Element Block	Description
Mux	The Xilinx Mux block implements a multiplexer. The block has one select input (type unsigned), and a user-configurable number of data bus inputs, ranging from 2 to 1024.
Parallel to Serial	The Parallel to Serial block takes an input word and splits it into N time-multiplexed output words where N is the ratio of number of input bits to output bits. The order of the output can be either least significant bit first or most significant bit first.
Register	The Xilinx Register block models a D flip-flop-based register, having latency of one sample period.
Reinterpret	The Xilinx Reinterpret block forces its output to a new type without any regard for retaining the numerical value represented by the input.
Relational	The Xilinx Relational block implements a comparator.
Requantize	The Xilinx Requantize block requantizes and scales its input signals.
Serial to Parallel	The Serial to Parallel block takes a series of inputs of any size and creates a single output of a specified multiple of that size. The input series can be ordered either with the most significant word first or the least significant word first.
Slice	The Xilinx Slice block allows you to slice off a sequence of bits from your input data and create a new data value. This value is presented as the output from the block. The output data type is unsigned with its binary point at zero.
System Generator	The System Generator token serves as a control panel for controlling system and simulation parameters, and it is also used to invoke the code generator for netlisting. Every Simulink model containing any element from the Xilinx Blockset must contain at least one System Generator token. Once a System Generator token is added to a model, it is possible to specify how code generation, and simulation should be handled.
Threshold	The Xilinx Threshold block tests the sign of the input number. If the input number is negative, the output of the block is -1; otherwise, the output is 1. The output is a signed fixed-point integer that is 2 bits long. The block has one input and one output.
Time Division Demultiplexer	The Xilinx Time Division Demultiplexer block accepts input serially and presents it to multiple outputs at a slower rate.
Time Division Multiplexer	The Xilinx Time Division Multiplexer block multiplexes values presented at input ports into a single faster rate output stream.
Up Sample	The Xilinx Up Sample block increases the sample rate at the point where the block is placed in your design. The output sample period is $1/n$, where l is the input sample period, and n is the sampling rate.

Communication Blocks

Table 3: Communication Blocks - FEC

Communication Block	Description
Convolution Encoder 9.0	The Xilinx Convolution Encoder block implements an encoder for convolution codes. Ordinarily used in tandem with a Viterbi decoder, this block performs forward error correction (FEC) in digital communication systems. This block adheres to the AMBA AXI4-Stream standard.
Depuncture	The Xilinx Depuncture block allows you to insert an arbitrary symbol into your input data at the location specified by the depuncture code.

Table 3: Communication Blocks - FEC (cont'd)

Communication Block	Description
Interleaver/De-interleaver 8.0	The Xilinx Interleaver Deinterleaver block implements an interleaver or a deinterleaver using an AXI4-compliant block interface. An interleaver is a device that rearranges the order of a sequence of input symbols. The term symbol is used to describe a collection of bits. In some applications, a symbol is a single bit. In others, a symbol is a bus.
Puncture	The Xilinx Puncture block removes a set of user-specified bits from the input words of its data stream.
Reed-Solomon Decoder 9.0	The Reed-Solomon (RS) codes are block-based error correcting codes with a wide range of applications in digital communications and storage. This block adheres to the AMBA AXI4-Stream standard.
Reed-Solomon Encoder 9.0	The Reed-Solomon (RS) codes are block-based error correcting codes with a wide range of applications in digital communications and storage. This block adheres to the AMBA AXI4-Stream standard.
Viterbi Decoder 9.1	Data encoded with a convolution encoder can be decoded using the Xilinx Viterbi decoder block. This block adheres to the AMBA AXI4-Stream standard.

Control Logic Blocks

Table 4: Control Logic Blocks

Control Logic Block	Description
AXI FIFO	The Xilinx AXI FIFO block implements a FIFO memory queue with an AXI-compatible block interface.
Black Box	The System Generator Black Box block provides a way to incorporate hardware description language (HDL) models into System Generator.
Constant	The Xilinx Constant block generates a constant that can be a fixed-point value, a Boolean value, or a DSP48 instruction. This block is similar to the Simulink constant block, but can be used to directly drive the inputs on Xilinx blocks.
Counter	The Xilinx Counter block implements a free-running or count-limited type of an up, down, or up/down counter. The counter output can be specified as a signed or unsigned fixed-point number.
Dual Port RAM	The Xilinx Dual Port RAM block implements a random access memory (RAM). Dual ports enable simultaneous access to the memory space at different sample rates using multiple data widths.
Expression	The Xilinx Expression block performs a bitwise logical expression.
FIFO	The Xilinx FIFO block implements an FIFO memory queue.
Inverter	The Xilinx Inverter block calculates the bitwise logical complement of a fixed-point number. The block is implemented as a synthesizable VHDL module.
Logical	The Xilinx Logical block performs bitwise logical operations on fixed-point numbers. Operands are zero padded and sign extended as necessary to make binary point positions coincide; then the logical operation is performed and the result is delivered at the output port.
MCode	The Xilinx MCode block is a container for executing a user-supplied MATLAB® function within Simulink. A parameter on the block specifies the M-function name. The block executes the M-code to calculate block outputs during a simulation. The same code is translated in a straightforward way into equivalent behavioral VHDL/Verilog when hardware is generated.
Mux	The Xilinx Mux block implements a multiplexer. The block has one select input (type unsigned) and a user-configurable number of data bus inputs, ranging from 2 to 1024.

Table 4: Control Logic Blocks (cont'd)

Control Logic Block	Description
Register	The Xilinx Register block models a D flip-flop-based register, having latency of one sample period.
Relational	The Xilinx Relational block implements a comparator.
ROM	The Xilinx ROM block is a single port read-only memory (ROM).
Shift	The Xilinx Shift block performs a left or right shift on the input signal. The result will have the same fixed-point container as that of the input.
Single Port RAM	The Xilinx Single Port RAM block implements a random access memory (RAM) with one data input and one data output port.
Slice	The Slice block allows you to slice off a sequence of bits from your input data and create a new data value. This value is presented as the output from the block. The output data type is unsigned with its binary point at zero.
Vitis HLS	The Xilinx Vitis™ HLS block allows the functionality of a design to be included in a System Generator design. The Vitis HLS design can include C, C++, and System C design sources.

Data Type Blocks

Table 5: Data Type Blocks

Data Type Block	Description
BitBasher	The Xilinx BitBasher block performs slicing, concatenation, and augmentation of inputs attached to the block.
Concat	The Xilinx Concat block performs a concatenation of n bit vectors represented by unsigned integer numbers, for example, n unsigned numbers with binary points at position zero.
Convert	The Xilinx Convert block converts each input sample to a number of a desired arithmetic type. For example, a number can be converted to a signed (two's complement), or unsigned value.
Gateway In	The Xilinx Gateway In blocks are the inputs into the Xilinx portion of your Simulink design. These blocks convert Simulink integer, double, and fixed-point data types into the System Generator fixed-point type. Each block defines a top-level input port or interface in the HDL design generated by System Generator.
Gateway Out	Xilinx Gateway Out blocks are the outputs from the Xilinx portion of your Simulink design. This block converts the System Generator fixed-point, or floating-point data type into a Simulink integer, single, double, or fixed-point data type.
Parallel to Serial	The Parallel to Serial block takes an input word and splits it into N time-multiplexed output words where N is the ratio of number of input bits to output bits. The order of the output can be either least significant bit first or most significant bit first.
Reinterpret	The Xilinx Reinterpret block forces its output to a new type without any regard for retaining the numerical value represented by the input.
Requantize	The Xilinx Requantize block requantizes and scales its input signals.
Scale	The Xilinx Scale block scales its input by a power of two. The power can be either positive or negative. The block has one input and one output. The scale operation has the effect of moving the binary point without changing the bits in the container
Serial to Parallel	The Serial to Parallel block takes a series of inputs of any size and creates a single output of a specified multiple of that size. The input series can be ordered either with the most significant word first or the least significant word first.

Table 5: Data Type Blocks (cont'd)

Data Type Block	Description
Shift	The Xilinx Shift block performs a left or right shift on the input signal. The result will have the same fixed-point container as that of the input.
Slice	The Xilinx Slice block allows you to slice off a sequence of bits from your input data and create a new data value. This value is presented as the output from the block. The output data type is unsigned with its binary point at zero.
Threshold	The Xilinx Threshold block tests the sign of the input number. If the input number is negative, the output of the block is -1; otherwise, the output is 1. The output is a signed fixed-point integer that is 2 bits long. The block has one input and one output.

DSP Blocks

Table 6: DSP Blocks

DSP Block	Description
CIC Compiler 4.0	The Xilinx CIC Compiler provides the ability to design and implement AXI4-Stream-compliant Cascaded Integrator-Comb (CIC) filters for a variety of Xilinx FPGA devices.
Complex Multiplier 6.0	The Complex Multiplier block implements AXI4-Stream compliant, high-performance, optimized complex multipliers for devices based on user-specified options.
CORDIC 6.0	The Xilinx CORDIC block implements a generalized coordinate rotational digital computer (CORDIC) algorithm and is AXI compliant.
DDS Compiler 6.0	The Xilinx DDS (Direct Digital Synthesizer) Compiler block implements high performance, optimized Phase Generation, and Phase to Sinusoid circuits with AXI4-Stream compliant interfaces for supported devices.
Digital FIR Filter	The Xilinx Digital FIR Filter block allows you to generate highly parameterizable, area-efficient, high-performance single channel FIR filters.
Divider Generator 5.1	The Xilinx Divider Generator block creates a circuit for integer division based on Radix-2 non-restoring division, or High-Radix division with prescaling.
DSP Macro 1.0	The System Generator DSP macro block provides a device independent abstraction of the DSP48E1, DSP48E2, and DSP58 blocks. Using this block instead of using a technology-specific DSP slice helps makes the design more portable between Xilinx technologies.
DSP48E	The Xilinx DSP48E block is an efficient building block for DSP applications that use supported devices. The DSP48E combines an 18-bit by 25-bit signed multiplier with a 48-bit adder and programmable mux to select the adder's input.
DSP48E1	The Xilinx DSP48E1 block is an efficient building block for DSP applications that use 7 series devices. Enhancements to the DSP48E1 slice provide improved flexibility and utilization, improved efficiency of applications, reduced overall power consumption, and increased maximum frequency. The high performance allows designers to implement multiple slower operations in a single DSP48E1 slice using time-multiplexing methods.
DSP48E2	The Xilinx DSP48E2 block is an efficient building block for DSP applications that use UltraScale™ devices. DSP applications use many binary multipliers and accumulators that are best implemented in dedicated DSP resources. UltraScale™ devices have many dedicated low-power DSP slices, combining high speed with small size while retaining system design flexibility.

Table 6: DSP Blocks (cont'd)

DSP Block	Description
DSP58	The Xilinx DSP58 block is an efficient building block for DSP applications that use Versal™ devices. DSP applications use many binary multipliers and accumulators that are best implemented in dedicated DSP resources. Versal™ devices have many dedicated low-power DSP slices, combining high speed with small size while retaining system design flexibility.
DSPCPLX	The Xilinx DSPCPLX block is one of the advanced features provided by Versal™ architecture DSP, which is the optimized solution to deal with 18x18 complex multiplication followed by 58 + 58 accumulation operation.
Fast Fourier Transform 9.1	The Xilinx Fast Fourier Transform block implements the Cooley-Tukey FFT algorithm, a computationally efficient method for calculating the Discrete Fourier Transform (DFT). In addition, the block provides an AXI4-Stream-compliant interface.
FDATool	The Xilinx FDATool block provides an interface to the FDATool software available as part of the MATLAB Signal Processing Toolbox.
FFT	The Xilinx FFT (Fast Fourier Transform) block takes a block of time domain waveform data and computes the frequency of the sinusoid signals that make up the waveform.
FIR Compiler 7.2	This Xilinx FIR Compiler block provides users with a way to generate highly parameterizable, area-efficient, high-performance FIR filters with an AXI4-Stream-compliant interface.
Inverse FFT	The Xilinx Inverse FFT block performs a fast inverse (or backward) Fourier transform (IDFT), which undoes the process of Discrete Fourier Transform (DFT). The Inverse FFT maps the signal back from the frequency domain into the time domain.
LFSR	The Xilinx LFSR block implements a Linear Feedback Shift Register (LFSR). This block supports both the Galois and Fibonacci structures using either the XOR or XNOR gate and allows a re-loadable input to change the current value of the register at any time. The LFSR output and re-loadable input can be configured as either serial or parallel ports
Opmode	The Xilinx Opmode block generates a constant that is a DSP48E, DSP48E1, or DSP48E2 instruction. It is a 15-bit instruction for DSP48E, a 20-bit instruction for DSP48E1, and a 22-bit instruction for DSP48E2. The instruction consists of the opmode, carry-in, carry-in select, alumode, and (for DSP48E1 and DSP48E2) the inmode bits.
Product	The Xilinx Product block implements a scalar or complex multiplier. It computes the product of the data on its two input channels, producing the result on its output channel. For complex multiplication the input and output have two components: real and imaginary.
Sine Wave	The Xilinx Sine Wave block generates a sine wave, using simulation time as the time source.

Floating-Point Blocks

The blocks in this library support the Floating-Point data type as well as other data types. Only a single data type is supported at a time. For example, a floating-point input produces a floating-point output; a fixed-point input produces a fixed-point output.

Table 7: Floating-Point Blocks

Floating-Point Block	Description
AXI FIFO	The Xilinx AXI FIFO block a FIFO memory queue with an AXI-compatible block interfimplementsace.

Table 7: Floating-Point Blocks (cont'd)

Floating-Point Block	Description
Absolute	The Xilinx Absolute block outputs the absolute value of the input.
Accumulator	The Xilinx Accumulator block implements an adder or subtractor-based scaling accumulator.
Addressable Shift Register	The Xilinx Addressable Shift Register block is a variable-length shift register in which any register in the delay chain can be addressed and driven onto the output data port.
AddSub	The Xilinx AddSub block implements an adder/subtractor. The operation can be fixed (Addition or Subtraction) or changed dynamically under control of the sub mode signal.
Assert	The Xilinx Assert block is used to assert a rate and/or a type on a signal. This block has no cost in hardware and can be used to resolve rates and/or types in situations where designer intervention is required.
Black Box	The System Generator Black Box block provides a way to incorporate hardware description language (HDL) models into System Generator.
CMult	The Xilinx CMult block implements a gain operator, with output equal to the product of its input by a constant value. This value can be a MATLAB expression that evaluates to a constant.
Constant	The Xilinx Constant block generates a constant that can be a fixed-point value, a Boolean value, or a DSP48 instruction. This block is similar to the Simulink constant block, but can be used to directly drive the inputs on Xilinx blocks.
Convert	The Xilinx Convert block converts each input sample to a number of a desired arithmetic type. For example, a number can be converted to a signed (two's complement), or unsigned value.
Delay	The Xilinx Delay block implements a fixed delay of L cycles.
Divide	The Xilinx Divide block performs both fixed-point and floating-point division with the a input being the dividend and the b input the divisor. Both inputs must be of the same data type.
Dual Port RAM	The Xilinx Dual Port RAM block implements a random access memory (RAM). Dual ports enable simultaneous access to the memory space at different sample rates using multiple data widths.
Exponential	This Xilinx Exponential block performs the exponential operation on the input. Currently, only the floating-point data type is supported.
Fast Fourier Transform 9.1	The Xilinx Fast Fourier Transform block implements the Cooley-Tukey FFT algorithm, a computationally efficient method for calculating the Discrete Fourier Transform (DFT). In addition, the block provides an AXI4-Stream-compliant interface.
FFT	The Xilinx FFT (Fast Fourier Transform) block takes a block of time domain waveform data and computes the frequency of the sinusoid signals that make up the waveform.
FIFO	The Xilinx FIFO block implements an FIFO memory queue.
Gateway In	The Xilinx Gateway In blocks are the inputs into the Xilinx portion of your Simulink design. These blocks convert Simulink integer, double, and fixed-point data types into the System Generator fixed-point type. Each block defines a top-level input port or interface in the HDL design generated by System Generator.
Gateway Out	Xilinx Gateway Out blocks are the outputs from the Xilinx portion of your Simulink design. This block converts the System Generator fixed-point or floating-point data type into a Simulink integer, single, double, or fixed-point data type.
Inverse FFT	The Xilinx Inverse FFT block performs a fast inverse (or backward) Fourier transform (IDFT), which undoes the process of Discrete Fourier Transform (DFT). The Inverse FFT maps the signal back from the frequency domain into the time domain.

Table 7: Floating-Point Blocks (cont'd)

Floating-Point Block	Description
Mult	The Xilinx Mult block implements a multiplier. It computes the product of the data on its two input ports, producing the result on its output port.
MultAdd	The Xilinx MultAdd block performs both fixed-point and floating-point multiply and addition with the a and b inputs used for the multiplication and the c input for addition or subtraction.
Mux	The Xilinx
Natural Logarithm	The Xilinx Mux block implements a multiplexer. Natural Logarithm block produces the natural logarithm of the input.
Negate	The Xilinx Negate block computes the arithmetic negation of its input.
Reciprocal	The Xilinx Reciprocal block performs the reciprocal on the input. Currently, only the floating-point data type is supported.
Reciprocal SquareRoot	The Xilinx Reciprocal SquareRoot block performs the reciprocal squareroot on the input. Currently, only the floating-point data type is supported.
Register	The Xilinx Register block models a D flip-flop-based register, having latency of one sample period.
Reinterpret	The Xilinx Reinterpret block forces its output to a new type without any regard for retaining the numerical value represented by the input.
Relational	The Xilinx Relational block implements a comparator.
ROM	The Xilinx ROM block is a single port read-only memory (ROM).
Single Port RAM	The Xilinx Single Port RAM block implements a random access memory (RAM) with one data input and one data output port.
SquareRoot	The Xilinx SquareRoot block performs the square root on the input. Currently, only the floating-point data type is supported.

Index Blocks

Table 8: Index Blocks

Index Block	Description
Absolute	The Xilinx Absolute block outputs the absolute value of the input.
Accumulator	The Xilinx Accumulator block implements an adder or subtractor-based scaling accumulator.
Addressable Shift Register	The Xilinx Addressable Shift Register block is a variable-length shift register in which any register in the delay chain can be addressed and driven onto the output data port.
AddSub	The Xilinx AddSub block implements an adder/subtractor. The operation can be fixed (Addition or Subtraction) or changed dynamically under control of the sub mode signal.
Assert	The Xilinx Assert block is used to assert a rate and/or a type on a signal. This block has no cost in hardware and can be used to resolve rates and/or types in situations where designer intervention is required.
AXI FIFO	The Xilinx AXI FIFO block implements a FIFO memory queue with an AXI-compatible block interface.
BitBasher	The Xilinx BitBasher block performs slicing, concatenation, and augmentation of inputs attached to the block.
Black Box	The System Generator Black Box block provides a way to incorporate hardware description language (HDL) models into System Generator.

Table 8: Index Blocks (cont'd)

Index Block	Description
CIC Compiler 4.0	The Xilinx CIC Compiler provides the ability to design and implement AXI4-Stream-compliant Cascaded Integrator-Comb (CIC) filters for a variety of Xilinx FPGA devices.
Clock Enable Probe	The Xilinx Clock Enable (CE) Probe provides a mechanism for extracting derived clock enable signals from Xilinx signals in System Generator models.
Clock Probe	The Xilinx Clock Probe generates a double-precision representation of a clock signal with a period equal to the Simulink system period.
CMult	The Xilinx CMult block implements a gain operator, with output equal to the product of its input by a constant value. This value can be a MATLAB expression that evaluates to a constant.
Complex Multiplier 6.0	The Complex Multiplier block implements AXI4-Stream compliant, high-performance, optimized complex multipliers for devices based on user-specified options.
Concat	The Xilinx Concat block performs a concatenation of n bit vectors represented by unsigned integer numbers, for example, n unsigned numbers with binary points at position zero.
Constant	The Xilinx Constant block generates a constant that can be a fixed-point value, a Boolean value, or a DSP48 instruction. This block is similar to the Simulink constant block, but can be used to directly drive the inputs on Xilinx blocks.
Convert	The Xilinx Convert block converts each input sample to a number of a desired arithmetic type. For example, a number can be converted to a signed (two's complement), or unsigned value.
Convolution Encoder 9.0	The Xilinx Convolution Encoder block implements an encoder for convolution codes. Ordinarily used in tandem with a Viterbi decoder, this block performs forward error correction (FEC) in digital communication systems. This block adheres to the AMBA AXI4-Stream standard.
CORDIC 6.0	The Xilinx CORDIC block implements a generalized coordinate rotational digital computer (CORDIC) algorithm and is AXI compliant.
Counter	The Xilinx Counter block implements a free-running or count-limited type of an up, down, or up/down counter. The counter output can be specified as a signed or unsigned fixed-point number.
DDS Compiler 6.0	The Xilinx DDS (Direct Digital Synthesizer) Compiler block implements high performance, optimized Phase Generation, and Phase to Sinusoid circuits with AXI4-Stream compliant interfaces for supported devices.
Delay	The Xilinx Delay block implements a fixed delay of L cycles.
Depuncture	The Xilinx Depuncture block allows you to insert an arbitrary symbol into your input data at the location specified by the depuncture code.
Digital FIR Filter	The Xilinx Digital FIR Filter block allows you to generate highly parameterizable, area-efficient, high-performance single channel FIR filters.
Divide	The Xilinx Divide block performs both fixed-point and floating-point division with the a input being the dividend and the b input the divisor. Both inputs must be of the same data type.
Divider Generator 5.1	The Xilinx Divider Generator block creates a circuit for integer division based on Radix-2 non-restoring division, or High-Radix division with prescaling.
Down Sample	The Xilinx Down Sample block reduces the sample rate at the point where the block is placed in your design.
DSP Macro 1.0	The System Generator DSP macro block provides a device independent abstraction of the DSP48E1, DSP48E2, and DSP58 blocks. Using this block instead of using a technology-specific DSP slice helps makes the design more portable between Xilinx technologies.

Table 8: Index Blocks (cont'd)

Index Block	Description
DSP48E	The Xilinx DSP48E block is an efficient building block for DSP applications that use supported devices. The DSP48E combines an 18-bit by 25-bit signed multiplier with a 48-bit adder and programmable mux to select the adder's input.
DSP48E1	The Xilinx DSP48E1 block is an efficient building block for DSP applications that use 7 series devices. Enhancements to the DSP48E1 slice provide improved flexibility and utilization, improved efficiency of applications, reduced overall power consumption, and increased maximum frequency. The high performance allows designers to implement multiple slower operations in a single DSP48E1 slice using time-multiplexing methods.
DSP48E2	The Xilinx DSP48E2 block is an efficient building block for DSP applications that use UltraScale devices. DSP applications use many binary multipliers and accumulators that are best implemented in dedicated DSP resources. UltraScale devices have many dedicated low-power DSP slices, combining high speed with small size while retaining system design flexibility.
DSP58	The Xilinx DSP58 block is an efficient building block for DSP applications that use Versal™ devices. DSP applications use many binary multipliers and accumulators that are best implemented in dedicated DSP resources. Versal™ devices have many dedicated low-power DSP slices, combining high speed with small size while retaining system design flexibility.
DSPCPLX	The Xilinx DSPCPLX block is one of the advanced features provided by Versal™ architecture DSP, which is the optimized solution to deal with 18x18 complex multiplication followed by 58 + 58 accumulation operation.
Dual Port RAM	The Xilinx Dual Port RAM block implements a random access memory (RAM). Dual ports enable simultaneous access to the memory space at different sample rates using multiple data widths.
Exponential	This Xilinx Exponential block performs the exponential operation on the input. Currently, only the floating-point data type is supported.
Expression	The Xilinx Expression block performs a bitwise logical expression.
Fast Fourier Transform 9.1	The Xilinx Fast Fourier Transform block implements the Cooley-Tukey FFT algorithm, a computationally efficient method for calculating the Discrete Fourier Transform (DFT). In addition, the block provides an AXI4-Stream-compliant interface.
FDATool	The Xilinx FDATool block provides an interface to the FDATool software available as part of the MATLAB Signal Processing Toolbox.
FFT	The Xilinx FFT (Fast Fourier Transform) block takes a block of time domain waveform data and computes the frequency of the sinusoid signals that make up the waveform.
FIFO	The Xilinx FIFO block implements an FIFO memory queue.
FIR Compiler 7.2	This Xilinx FIR Compiler block provides users with a way to generate highly parameterizable, area-efficient, high-performance FIR filters with an AXI4-Stream-compliant interface.
Gateway In	The Xilinx Gateway In blocks are the inputs into the Xilinx portion of your Simulink design. These blocks convert Simulink integer, double, and fixed-point data types into the System Generator fixed-point type. Each block defines a top-level input port or interface in the HDL design generated by System Generator.
Gateway Out	Xilinx Gateway Out blocks are the outputs from the Xilinx portion of your Simulink design. This block converts the System Generator fixed-point or floating-point data type into a Simulink integer, single, double, or fixed-point data type.
Indeterminate Probe	The output of the Xilinx Indeterminate Probe indicates whether the input data is indeterminate (MATLAB value NaN). An indeterminate data value corresponds to a VHDL indeterminate logic data value of 'X'.

Table 8: Index Blocks (cont'd)

Index Block	Description
Interleaver/De-interleaver 8.0	The Xilinx Interleaver Deinterleaver block implements an interleaver or a deinterleaver using an AXI4-compliant block interface. An interleaver is a device that rearranges the order of a sequence of input symbols. The term symbol is used to describe a collection of bits. In some applications, a symbol is a single bit. In others, a symbol is a bus.
Inverse FFT	The Xilinx Inverse FFT block performs a fast inverse (or backward) Fourier transform (IDFT), which undoes the process of Discrete Fourier Transform (DFT). The Inverse FFT maps the signal back from the frequency domain into the time domain.
Inverter	The Xilinx Inverter block calculates the bitwise logical complement of a fixed-point number. The block is implemented as a synthesizable VHDL module.
LFSR	The Xilinx LFSR block implements a Linear Feedback Shift Register (LFSR). This block supports both the Galois and Fibonacci structures using either the XOR or XNOR gate and allows a re-loadable input to change the current value of the register at any time. The LFSR output and re-loadable input can be configured as either serial or parallel ports
Logical	The Xilinx Logical block performs bitwise logical operations on fixed-point numbers. Operands are zero padded and sign extended as necessary to make binary point positions coincide; then the logical operation is performed and the result is delivered at the output port.
MCode	The Xilinx MCode block is a container for executing a user-supplied MATLAB function within Simulink. A parameter on the block specifies the M-function name. The block executes the M-code to calculate block outputs during a Simulink simulation. The same code is translated in a straightforward way into equivalent behavioral VHDL/Verilog when hardware is generated.
ModelSim	The System Generator Black Box block provides a way to incorporate existing HDL files into a model. When the model is simulated, co-simulation can be used to allow black boxes to participate. The ModelSim HDL co-simulation block configures and controls co-simulation for one or several black boxes.
Mult	The Xilinx Mult block implements a multiplier. It computes the product of the data on its two input ports, producing the result on its output port.
MultAdd	The Xilinx MultAdd block performs both fixed-point and floating-point multiply and addition with the a and b inputs used for the multiplication and the c input for addition or subtraction.
Mux	The Xilinx Mux block implements a multiplexer. The block has one select input (type unsigned) and a user-configurable number of data bus inputs, ranging from 2 to 1024.
Natural Logarithm	The Xilinx Natural Logarithm block produces the natural logarithm of the input.
Negate	The Xilinx Negate block computes the arithmetic negation of its input.
Opmode	The Xilinx Opmode block generates a constant that is a DSP48E, DSP48E1, or DSP48E2 instruction. It is a 15-bit instruction for DSP48E, a 20-bit instruction for DSP48E1, and a 22-bit instruction for DSP48E2. The instruction consists of the opmode, carry-in, carry-in select, alumode, and (for DSP48E1 and DSP48E2) the inmode bits.
Parallel to Serial	The Parallel to Serial block takes an input word and splits it into N time-multiplexed output words where N is the ratio of number of input bits to output bits. The order of the output can be either least significant bit first or most significant bit first.
Product	The Xilinx Product block implements a scalar or complex multiplier. It computes the product of the data on its two input channels, producing the result on its output channel. For complex multiplication the input and output have two components: real and imaginary.
Puncture	The Xilinx Puncture block removes a set of user-specified bits from the input words of its data stream.

Table 8: Index Blocks (cont'd)

Index Block	Description
Reciprocal	The Xilinx Reciprocal block performs the reciprocal on the input. Currently, only the floating-point data type is supported.
Reciprocal SquareRoot	The Xilinx Reciprocal SquareRoot block performs the reciprocal squareroot on the input. Currently, only the floating-point data type is supported.
Reed-Solomon Decoder 9.0	The Reed-Solomon (RS) codes are block-based error correcting codes with a wide range of applications in digital communications and storage.
Reed-Solomon Encoder 9.0	The Reed-Solomon (RS) codes are block-based error correcting codes with a wide range of applications in digital communications and storage. This block adheres to the AMBA AXI4-Stream standard.
Register	The Xilinx Register block models a D flip-flop-based register, having latency of one sample period.
Reinterpret	The Xilinx Reinterpret block forces its output to a new type without any regard for retaining the numerical value represented by the input.
Relational	The Xilinx Relational block implements a comparator.
Requantize	The Xilinx Requantize block requantizes and scales its input signals.
ROM	The Xilinx ROM block is a single port read-only memory (ROM).
Sample Time	The Sample Time block reports the normalized sample period of its input. A signal's normalized sample period is not equivalent to its Simulink absolute sample period. In hardware, this block is implemented as a constant.
Scale	The Xilinx Scale block scales its input by a power of two. The power can be either positive or negative. The block has one input and one output. The scale operation has the effect of moving the binary point without changing the bits in the container.
Serial to Parallel	The Serial to Parallel block takes a series of inputs of any size and creates a single output of a specified multiple of that size. The input series can be ordered either with the most significant word first or the least significant word first.
Shift	The Xilinx Shift block performs a left or right shift on the input signal. The result will have the same fixed-point container as that of the input.
Single Port RAM	The Xilinx Single Port RAM block implements a random access memory (RAM) with one data input and one data output port.
Sine Wave	The Xilinx Sine Wave block generates a sine wave, using simulation time as the time source.
Slice	The Xilinx Slice block allows you to slice off a sequence of bits from your input data and create a new data value. This value is presented as the output from the block. The output data type is unsigned with its binary point at zero.
SquareRoot	The Xilinx SquareRoot block performs the square root on the input. Currently, only the floating-point data type is supported.
System Generator	The System Generator token serves as a control panel for controlling system and simulation parameters, and it is also used to invoke the code generator for netlisting. Every Simulink model containing any element from the Xilinx Blockset must contain at least one System Generator token. Once a System Generator token is added to a model, it is possible to specify how code generation and simulation should be handled.
Threshold	The Xilinx Threshold block tests the sign of the input number. If the input number is negative, the output of the block is -1; otherwise, the output is 1. The output is a signed fixed-point integer that is 2 bits long. The block has one input and one output.
Time Division Demultiplexer	The Xilinx Time Division Demultiplexer block accepts input serially and presents it to multiple outputs at a slower rate.
Time Division Multiplexer	The Xilinx Time Division Multiplexer block multiplexes values presented at input ports into a single faster rate output stream.

Table 8: Index Blocks (cont'd)

Index Block	Description
Toolbar	The Xilinx Toolbar block provides quick access to several useful utilities in System Generator. The Toolbar simplifies the use of the zoom feature in Simulink and adds new auto layout and route capabilities to Simulink models.
Up Sample	The Xilinx Up Sample block increases the sample rate at the point where the block is placed in your design. The output sample period is $1/n$, where l is the input sample period, and n is the sampling rate.
Viterbi Decoder 9.1	Data encoded with a convolution encoder can be decoded using the Xilinx Viterbi decoder block. This block adheres to the AMBA® AXI4-Stream standard.
Vitis HLS	The Xilinx Vitis HLS block allows the functionality of a Vitis HLS design to be included in a System Generator design. The Vitis HLS design can include C, C++, and the System C design sources.

Math Blocks

Table 9: Math Blocks

Math Block	Description
Absolute	The Xilinx Absolute block outputs the absolute value of the input.
Accumulator	The Xilinx Accumulator block implements an adder or subtractor-based scaling accumulator.
AddSub	The Xilinx AddSub block implements an adder/subtractor. The operation can be fixed (Addition or Subtraction) or changed dynamically under control of the sub mode signal.
CMult	The Xilinx CMult block implements a gain operator, with output equal to the product of its input by a constant value. This value can be a MATLAB expression that evaluates to a constant.
Complex Multiplier 6.0	The Complex Multiplier block implements AXI4-Stream compliant, high-performance, optimized complex multipliers for devices based on user-specified options.
Constant	The Xilinx Constant block generates a constant that can be a fixed-point value, a Boolean value, or a DSP48 instruction. This block is similar to the Simulink constant block, but can be used to directly drive the inputs on Xilinx blocks.
Convert	The Xilinx Convert block converts each input sample to a number of a desired arithmetic type. For example, a number can be converted to a signed (two's complement), or unsigned value.
CORDIC 6.0	The Xilinx CORDIC block implements a generalized coordinate rotational digital computer (CORDIC) algorithm and is AXI compliant.
Counter	The Xilinx Counter block implements a free-running or count-limited type of an up, down, or up/down counter. The counter output can be specified as a signed or unsigned fixed-point number.
Divide	The Xilinx Divide block performs both fixed-point and floating-point division with the a input being the dividend and the b input the divisor. Both inputs must be of the same data type.
Divider Generator 5.1	The Xilinx Divider Generator block creates a circuit for integer division based on Radix-2 non-restoring division, or High-Radix division with prescaling.
Exponential	This Xilinx Exponential block performs the exponential operation on the input. Currently, only the floating-point data type is supported.
Expression	The Xilinx Expression block performs a bitwise logical expression.
Inverter	The Xilinx Inverter block calculates the bitwise logical complement of a fixed-point number. The block is implemented as a synthesizable VHDL module.

Table 9: Math Blocks (cont'd)

Math Block	Description
Logical	The Xilinx Logical block performs bitwise logical operations on fixed-point numbers. Operands are zero padded and sign extended as necessary to make binary point positions coincide; then the logical operation is performed and the result is delivered at the output port.
MCode	The Xilinx MCode block is a container for executing a user-supplied MATLAB function within Simulink. A parameter on the block specifies the M-function name. The block executes the M-code to calculate block outputs during a Simulink simulation. The same code is translated in a straightforward way into equivalent behavioral VHDL/Verilog when hardware is generated.
Mult	The Xilinx Mult block implements a multiplier. It computes the product of the data on its two input ports, producing the result on its output port.
MultAdd	The Xilinx MultAdd block performs both fixed-point and floating-point multiply and addition with the a and b inputs used for the multiplication and the c input for addition or subtraction.
Natural Logarithm	The Xilinx Natural Logarithm block produces the natural logarithm of the input.
Negate	The Xilinx Negate block computes the arithmetic negation of its input.
Product	The Xilinx Product block implements a scalar or complex multiplier. It computes the product of the data on its two input channels, producing the result on its output channel. For complex multiplication the input and output have two components: real and imaginary.
Reciprocal	The Xilinx Reciprocal block performs the reciprocal on the input. Currently, only the floating-point data type is supported.
Reciprocal SquareRoot	The Xilinx Reciprocal SquareRoot block performs the reciprocal squareroot on the input. Currently, only the floating-point data type is supported.
Reinterpret	The Xilinx Reinterpret block forces its output to a new type without any regard for retaining the numerical value represented by the input.
Relational	The Xilinx Relational block implements a comparator.
Requantize	The Xilinx Requantize block requantizes and scales its input signals.
Scale	The Xilinx Scale block scales its input by a power of two. The power can be either positive or negative. The block has one input and one output. The scale operation has the effect of moving the binary point without changing the bits in the container
Shift	The Xilinx Shift block performs a left or right shift on the input signal. The result will have the same fixed-point container as that of the input.
SquareRoot	The Xilinx SquareRoot block performs the square root on the input. Currently, only the floating-point data type is supported.
Threshold	The Xilinx Threshold block tests the sign of the input number. If the input number is negative, the output of the block is -1; otherwise, the output is 1. The output is a signed fixed-point integer that is 2 bits long. The block has one input and one output.

Memory Blocks

Table 10: Memory Blocks

Memory Block	Description
Addressable Shift Register	The Xilinx Addressable Shift Register block is a variable-length shift register in which any register in the delay chain can be addressed and driven onto the output data port.

Table 10: Memory Blocks (cont'd)

Memory Block	Description
AXI FIFO	The Xilinx AXI FIFO block implements a FIFO memory queue with an AXI-compatible block interface.
Delay	The Xilinx Delay block implements a fixed delay of L cycles.
Dual Port RAM	The Xilinx Dual Port RAM block implements a random access memory (RAM). Dual ports enable simultaneous access to the memory space at different sample rates using multiple data widths.
FIFO	The Xilinx FIFO block implements an FIFO memory queue.
LFSR	The Xilinx LFSR block implements a Linear Feedback Shift Register (LFSR). This block supports both the Galois and Fibonacci structures using either the XOR or XNOR gate and allows a re-loadable input to change the current value of the register at any time. The LFSR output and re-loadable input can be configured as either serial or parallel ports
ROM	The Xilinx ROM block is a single port read-only memory (ROM).
Register	The Xilinx Register block models a D flip-flop-based register, having latency of one sample period.
Single Port RAM	The Xilinx Single Port RAM block implements a random access memory (RAM) with one data input and one data output port.

Tool Blocks

Table 11: Tool Blocks

Tool Block	Description
Clock Probe	The Xilinx Clock Probe generates a double-precision representation of a clock signal with a period equal to the Simulink system period.
FDATool	The Xilinx FDATool block provides an interface to the FDATool software available as part of the MATLAB Signal Processing Toolbox.
Indeterminate Probe	The output of the Xilinx Indeterminate Probe indicates whether the input data is indeterminate (MATLAB value NaN). An indeterminate data value corresponds to a VHDL indeterminate logic data value of 'X'.
ModelSim	The System Generator Black Box block provides a way to incorporate existing HDL files into a model. When the model is simulated, co-simulation can be used to allow black boxes to participate. The ModelSim HDL co-simulation block configures and controls co-simulation for one or several black boxes.
Sample Time	The Sample Time block reports the normalized sample period of its input. A signal's normalized sample period is not equivalent to its Simulink absolute sample period. In hardware, this block is implemented as a constant.
System Generator	The System Generator token serves as a control panel for controlling system and simulation parameters, and it is also used to invoke the code generator for netlisting. Every Simulink model containing any element from the Xilinx Blockset must contain at least one System Generator token. Once a System Generator token is added to a model, it is possible to specify how code generation and simulation should be handled.
Toolbar	The Xilinx Toolbar block provides quick access to several useful utilities in System Generator. The Toolbar simplifies the use of the zoom feature in Simulink and adds new auto layout and route capabilities to Simulink models.

Simulink Blocks Supported by System Generator

In general, Simulink blocks can be included in a Xilinx design for simulation purposes, but will not be mapped to Xilinx hardware. However, the following Simulink blocks are fully supported by System Generator and are mapped to Xilinx hardware:

Table 12: Simulink Blocks Supported by System Generator

Simulink Block	Description
Demux	The Demux block extracts the components of an input signal and outputs the components as separate signals.
From	The From block accepts a signal from a corresponding Goto block, then passes it as output.
Goto	The Goto block passes its input to its corresponding From blocks.
Mux	The Mux block combines its inputs into a single vector output.

Refer to the corresponding Simulink documentation for a complete description of the block.

Common Options in Block Parameter Dialog Boxes

Each Xilinx® block has several controls and configurable parameters, seen in its block parameters dialog box. This dialog box can be accessed by double-clicking on the block. Many of these parameters are specific to the block. Block-specific parameters are described in the documentation for the block.

The remaining controls and parameters are common to most blocks. These common controls and parameters are described below.

Each dialog box contains four buttons: **OK**, **Cancel**, **Help**, and **Apply**. **Apply** applies configuration changes to the block, leaving the box open on the screen. **Help** displays HTML help for the block. **Cancel** closes the box without saving changes. **OK** applies changes and closes the box.

Precision

The fundamental computational mode in the Xilinx blockset is arbitrary precision fixed-point arithmetic. Most blocks give you the option of choosing the precision, for example, the number of bits and binary point position.

By default, the output of Xilinx blocks is *full* precision; that is, sufficient precision to represent the result without error. Most blocks have a *User-Defined* precision option that fixes the number of total and fractional bits.

Arithmetic Type

In the **Type** field of the block parameters dialog box, you can choose unsigned or signed (two's complement) as the data type of the output signal.

Number of Bits

Fixed-point numbers are stored in data types characterized by their word size as specified by number of bits, binary point, and arithmetic type parameters. The maximum number of bits supported is 4096.

Binary Point

The binary point is the means by which fixed-point numbers are scaled. The binary point parameter indicates the number of bits to the right of the binary point (for example, the size of the fraction) for the output port. The binary point position must be between zero and the specified number of bits.

Overflow and Quantization

When user-defined precision is selected, errors can result from overflow or quantization. Overflow errors occur when a value lies outside the representable range. Quantization errors occur when the number of fractional bits is insufficient to represent the fractional portion of a value.

The Xilinx fixed-point data type supports several options for user-defined precision. For overflow the options are to **Saturate** to the largest positive/smallest negative value, to **Wrap** (for example, to discard bits to the left of the most significant representable bit), or to **Flag as error** (an overflow as a Simulink® error) during simulation. **Flag as error** is a simulation only feature. The hardware generated is the same as when **Wrap** is selected.

For quantization, the options are to **Round** to the nearest representable value (or to the value furthest from zero if there are two equidistant nearest representable values), or to **Truncate** (for example, to discard bits to the right of the least significant representable bit).

The following is an image showing the Quantization and Overflow options.

Figure 1: Quantization and Overflow Options

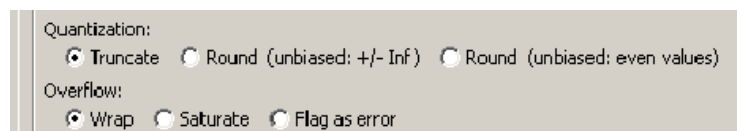

Round(unbiased: +/- inf) also known as "Symmetric Round (towards +/- inf)" or "Symmetric Round (away from zero)". This is similar to the MATLAB® `round()` function. This method rounds the value to the nearest desired bit away from zero and when there is a value at the midpoint between two possible rounded values, the one with the larger magnitude is selected. For example, to round 01.0110 to a Fix_4_2, this yields 01.10, because 01.0110 is exactly between 01.01 and 01.10 and the latter is further from zero.

Round (unbiased: even values) also known as "Convergent Round (toward even)" or "Unbiased Rounding". Symmetric rounding is biased because it rounds all ambiguous midpoints away from zero which means the average magnitude of the rounded results is larger than the average magnitude of the raw results. Convergent rounding removes this by alternating between a symmetric round toward zero and symmetric round away from zero. That is, midpoints are rounded toward the nearest even number. For example, to round 01.0110 to a Fix_4_2, this yields 01.10, because 01.0110 is exactly between 01.01 and 01.10 and the latter is even. To round 01.1010 to a Fix_4_2, this yields 01.10, because 01.1010 is exactly between 01.10 and 01.11 and the former is even.

It is important to realize that whatever option is selected, the generated HDL model and Simulink model behave identically.

Latency

Many elements in the Xilinx blockset have a latency option. This defines the number of sample periods by which the block's output is delayed. One sample period might correspond to multiple clock cycles in the corresponding FPGA implementation (for example, when the hardware is over-clocked with respect to the Simulink model). System Generator does not perform extensive pipelining; additional latency is usually implemented as a shift register on the output of the block.

Provide Synchronous Reset Port

Selecting the **Provide Synchronous Reset Port** option activates an optional reset (`rst`) pin on the block.

When the reset signal is asserted the block goes back to its initial state. Reset signal has precedence over the optional enable signal available on the block. The reset signal has to run at a multiple of the block's sample rate. The signal driving the reset port must be Boolean.

Provide Enable Port

Selecting the **Provide Enable Port** option activates an optional enable (`en`) pin on the block. When the enable signal is not asserted the block holds its current state until the enable signal is asserted again or the reset signal is asserted. Reset signal has precedence over the enable signal. The enable signal has to run at a multiple of the block's sample rate. The signal driving the enable port must be Boolean.

Sample Period

Data streams are processed at a specific sample rate as they flow through Simulink. Typically, each block detects the input sample rate and produces the correct sample rate on its output. Xilinx blocks Up Sample and Down Sample provide a means to increase or decrease sample rates.

Specify Explicit Sample Period

If you select **Specify explicit sample period** rather than the default, you can set the sample period required for all the block outputs. This is useful when implementing features such as feedback loops in your design. In a feedback loop, it is not possible for System Generator to determine a default sample rate, because the loop makes an input sample rate depend on a yet-to-be-determined output sample rate. System Generator under these circumstances requires you to supply a hint to establish sample periods throughout a loop.

Use Behavioral HDL (otherwise use core)

When this checkbox is checked, the behavioral HDL generated by the M-code simulation is used instead of the structural HDL from the cores.

The M-code simulation creates the C simulation and this C simulation creates behavioral HDL. When this option is selected, it is this behavioral HDL that is used for further synthesis. When this option is not selected, the structural HDL generated from the cores and HDL templates (corresponding to each of the blocks in the model) is used instead for synthesis. Cores are generated for each block in a design once and cached for future netlisting. This capability ensures the fastest possible netlist generation while guaranteeing that the cores are available for downstream synthesis and place and route tools.

Use XtremeDSP Slice

This field specifies that if possible, use the XtremeDSP slice (DSP48 type element) in the target device. Otherwise, CLB logic are used for the multipliers.

Display shortened port names

AXI4-Stream signal names have been shortened (by default) to improve readability on the block. Name shortening is purely cosmetic and when netlisting occurs, the AXI4-Stream name is used. For example, a shortened master signal on an AXI4-Stream interface might be `data_tvalid`. When you check **Display shortened port names**, the name becomes `m_axis_data_tvalid`.

Block Reference Pages

Following is an alphabetic listing of the blocks in the Xilinx blockset, with descriptions of each of the blocks.

Absolute

This block is listed in the following Xilinx® Blockset libraries: Math, Floating-Point, Basic Elements and Index.

The Xilinx Absolute block outputs the absolute value of the input.

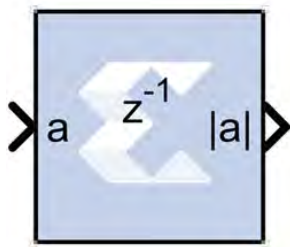

Block Parameters

The block parameters dialog box can be invoked by double-clicking the icon in your Simulink® model.

- **Basic tab:**
 - **Precision:** This parameter allows you to specify the output precision for fixed-point arithmetic. Floating point arithmetic output will always be **Full** precision.
 - **Full:** The block uses sufficient precision to represent the result without error.
 - **User Defined:** If you do not need full precision, this option allows you to specify a reduced number of total bits and/or fractional bits.
 - **Fixed-point Output Type:**
 - **Arithmetic type:**
 - **Signed (2's comp):** The output is a Signed (2's complement) number.
 - **Unsigned:** The output is an Unsigned number.
 - **Fixed-point Precision:**
 - **Number of bits:** Specifies the bit location of the binary point of the output number, where bit zero is the least significant bit.
 - **Binary point:** Position of the binary point. in the fixed-point output.
 - **Quantization:**

Refer to the section [Overflow and Quantization](#).

- **Overflow:** Refer to the section [Overflow and Quantization](#).

Other parameters used by this block are explained in the topic [Common Options in Block Parameter Dialog Boxes](#).

LogiCORE Documentation

[LogiCORE IP Floating-Point Operator v7.1](#)

Accumulator

This block is listed in the following Xilinx Blockset libraries: Math and Index and Floating-Point.

The Xilinx® Accumulator block implements an adder or subtractor-based scaling accumulator.

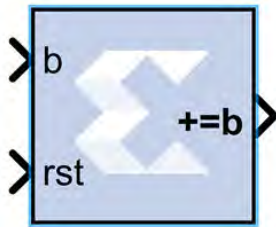

The block's current input is accumulated with a scaled current stored value. The scale factor is a block parameter.

Block Interface

The block has an input b and an output q . The output must have the same width as the input data. The output will have the same arithmetic type and binary point position as the input. The output q is calculated as follows:

$$q(n) = \begin{cases} 0 & \text{if } rst = 1 \\ q(n-1) \times FeedbackScaling + h(n-1) & \text{otherwise} \end{cases}$$

A subtractor-based accumulator replaces addition of the current input $b(n)$ with subtraction.

Block Parameters

The block parameters dialog box can be invoked by double-clicking the icon in your Simulink® model.

- **Basic tab:**

Parameters specific to the Basic tab are as follows:

- **Operation:** This determines whether the block is adder- or subtractor-based.
- **Fixed-Point Output Precision:**
 - **Number of bits:** specifies the bit location of the binary point of the output number, where bit zero is the least significant bit.
 - **Overflow:** Refer to the section [Overflow and Quantization](#).
- **Feedback scaling:** Specifies the feedback scale factor to be one of the following:
1, 1/2, 1/4, 1/8, 1/16, 1/32, 1/64, 1/128, or 1/256.
- **Optional Ports:**
 - **Provide synchronous reset port:** Activates an optional reset (rst) pin on the block. When the reset signal is asserted, the block goes back to its initial state. Reset signal has precedence over the optional enable signal available on the block. The reset signal must run at a multiple of the block's sample rate. The signal driving the reset port must be Boolean.
- **Bypass Option on Reset:**
 - **Reinitialize with input 'b':** When selected, the output of the accumulator is reset to the data on input port *b*. When not selected, the output of the accumulator is reset to zero. This option is available only when the block has a reset port. Using this option has clock speed implications if the accumulator is in a multirate system. In this case the accumulator is forced to run at the system rate because the clock enable (CE) signal driving the accumulator runs at the system rate, and the reset to input operation is a function of the CE signal.
- **Internal Precision tab:** Parameters specific to the Internal Precision tab are as follows:
 - **Floating Point Precision:**
 - **Input MSB Max:** The Most Significant Bit of the largest number that can be accepted.
 - **Output MSB Max:** The MSB of the largest result. It can be up to 54 bits greater than the Input MSB.
 - **Output LSB Min:** The Least Significant Bit of the smallest number that can be accepted. It is also the LSB of the accumulated result.
- **Implementation tab:** Parameters specific to the Implementation tab are as follows:
 - **Use behavioral HDL (otherwise use core):** The block is implemented using behavioral HDL. This gives the downstream logic synthesis tool maximum freedom to optimize for performance or area.
 - **Implement using:** Core logic can be implemented in **Fabric** or in a **DSP48**, if a DSP48 is available in the target device. The default is **Fabric**.

Other parameters used by this block are explained in the topic [Common Options in Block Parameter Dialog Boxes](#).

The Accumulator block always has a latency of 1.

LogiCORE Documentation

[LogiCORE IP Accumulator v12.0](#)

Addressable Shift Register

This block is listed in the following Xilinx Blockset libraries: Basic Elements, Floating-Point, Memory and Index.

The Xilinx Addressable Shift Register block is a variable-length shift register in which any register in the delay chain can be addressed and driven onto the output data port.



The block operation is most easily thought of as a chain of registers, where each register output drives an input to a multiplexer, as shown below. The multiplexer select line is driven by the address port (addr). The output data port is shown below as q.

Figure 2: Output Data Port

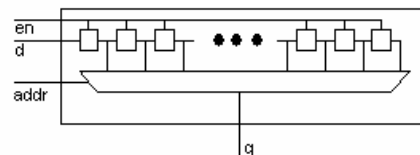

The Addressable Shift Register has a maximum depth of 1024 and a minimum depth of 2. The address input port, therefore, can be between 1 and 10 bits (inclusive). The data input port width must be between 1 and 255 bits (inclusive) when this block is implemented with the Xilinx LogiCORE (for example, when **Use behavioral HDL (otherwise use core)** is unchecked).

In hardware, the address port is asynchronous relative to the output port. In the block S-function, the address port is therefore given priority over the input data port, for example, on each successive cycle, the addressed data value is read from the register and driven to the output before the shift operation occurs. This order is needed in the Simulink® software model to guarantee one clock cycle of latency between the data port and the first register of the delay chain. (If the shift operation were to come first, followed by the read, then there would be no delay, and the hardware would be incorrect.)

Block Interface

The block interface (inputs and outputs as seen on the Addressable Shift Register icon) are as follows:

d	data input
addr	address
en	enable signal (optional)
q	data output

Block Parameters

The block parameters dialog box can be invoked by double-clicking the icon in your Simulink® model.d.

- **Basic tab:** Parameters specific to this block are as follows:
 - **Infer maximum latency (depth) using address port width:** You can choose to allow the block to automatically determine the depth or maximum latency of the shift-register-based on the bit-width of the address port.
 - **Maximum latency (depth):** In the case that the maximum latency is not inferred (previous option), the maximum latency can be set explicitly.
 - **Initial value vector:** Specifies the initial register values. When the vector is longer than the shift register depth, the vector's trailing elements are discarded. When the shift register is deeper than the vector length, the shift register's trailing registers are initialized to zero.

Other parameters used by this block are explained in the topic [Common Options in Block Parameter Dialog Boxes](#).

- **Implementation tab:** Parameters specific to this block are as follows:
 - **Optimization:** You can choose to optimize for **Resource** (minimum area) or for **Speed** (maximum performance).

LogiCORE Documentation

[LogiCORE IP RAM-based Shift Register v12.0](#)

LogiCORE IP Floating-Point Operator v7.1

AddSub

This block is listed in the following Xilinx Blockset libraries: Math, Floating-Point and Index.

The Xilinx AddSub block implements an adder/subtractor. The operation can be fixed (Addition or Subtraction) or changed dynamically under control of the sub mode signal.

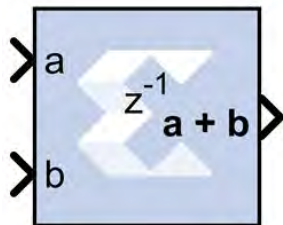

Block Parameters

The block parameters dialog box can be invoked by double-clicking the icon in your Simulink model.

- **Basic tab:** Parameters specific to the Basic tab are as follows:
 - **Operation:** Specifies the block operation to be Addition, Subtraction, or Addition/Subtraction. When Addition/Subtraction is selected, the block operation is determined by the sub input port, which must be driven by a Boolean signal. When the sub input is 1, the block performs subtraction. Otherwise, it performs addition.
 - **Provide carry-in port:** When selected, allows access to the carry-in port, cin.
 - **Provide carry-out port:** When selected, allows access to the carry-out port, cout. The carry-out port is available only when **User defined** precision is selected, the inputs and output are unsigned, and the number of output integer bits equals x, where $x = \max(\text{integer bits } a, \text{integer bits } b)$.
 - **Latency:** The **Latency** value defines the number of sample periods by which the block's output is delayed. One sample period might correspond to multiple clock cycles in the corresponding FPGA implementation (for example, when the hardware is over-clocked with respect to the Simulink model). System Generator will not perform extensive pipelining unless you select the **Pipeline for maximum performance** option (on the Implementation tab, described below); additional latency is usually implemented as a shift register on the output of the block.
- **Output tab:**
 - **Precision:**

This parameter allows you to specify the output precision for fixed-point arithmetic. Floating point arithmetic output will always be **Full** precision.

- **Full:** The block uses sufficient precision to represent the result without error.
- **User Defined:** If you do not need full precision, this option allows you to specify a reduced number of total bits and/or fractional bits.
- **Fixed-point Output Type:**
 - **Arithmetic Type:**
 - **Signed (2's comp):** The output is a Signed (2's complement) number.
 - **Unsigned:** The output is an Unsigned number.
 - **Fixed -point Precision:**
 - **Number of bits:** Specifies the bit location of the binary point of the output number, where bit zero is the least significant bit.
 - **Binary point:** Position of the binary point in the fixed-point output.
- **Quantization:** Refer to the section [Overflow and Quantization](#).
- **Overflow:** Refer to the section [Overflow and Quantization](#).
- **Implementation tab:**

Parameters specific to the Implementation tab are as follows:

- **Use behavioral HDL (otherwise use core):** The block is implemented using behavioral HDL. This gives the downstream logic synthesis tool maximum freedom to optimize for performance or area.

Note: For Floating-point operations, the block always uses the Floating-point Operator core.

- **Core Parameters:**
 - **Pipeline for maximum performance:**

The XILINX LogiCORE can be internally pipelined to optimize for speed instead of area. Selecting this option puts all user defined latency into the core until the maximum allowable latency is reached. If the **Pipeline for maximum performance** option is not selected and latency is greater than zero, a single output register is put in the core and additional latency is added on the output of the core.

The **Pipeline for maximum performance** option adds the pipeline registers throughout the block, so that the latency is distributed, instead of adding it only at the end. This helps to meet tight timing constraints in the design.

- **Implement using:** Core logic can be implemented in **Fabric**, or in a **DSP48**, if a DSP48 is available in the target device. The default is **Fabric**.

Other parameters used by this block are explained in the topic [Common Options in Block Parameter Dialog Boxes](#).

LogiCORE Documentation

[LogiCORE IP Adder/Subtractor v12.0](#)

[LogiCORE IP Floating-Point Operator v7.1](#)

Assert

This block is listed in the following Xilinx Blockset libraries: Basic Elements, Floating-Point and Index.

The Xilinx Assert block is used to assert a rate and/or a type on a signal. This block has no cost in hardware and can be used to resolve rates and/or types in situations where designer intervention is required.



Block Parameters

The block parameters dialog box can be invoked by double-clicking the icon in your Simulink® model.

Parameters specific to this block are as follows:

- **Type:**
 - **Assert type:** Specifies whether or not the block will assert that the type at its input is the same as the type specified. If the types are not the same, an error message is reported. This block is listed in the following Xilinx Blockset libraries: Floating-Point and Index.
 - **Specify type:** Specifies whether or not the type to assert is provided from a signal connected to an input port named **type** or whether it is specified **Explicitly** from parameters in the Assert block dialog box.
 - **Output Type:** Specifies the data type of the output. Can be **Boolean**, **Fixed-point**, or **Floating-point**.

- **Arithmetic Type:** If the Output Type is specified as Fixed-point, you can select **Signed (2's comp)** or **Unsigned** as the Arithmetic Type.
 - **Fixed-point Precision:**
 - **Number of bits:** Specifies the bit location of the binary point of the output number, where bit zero is the least significant bit.
 - **Binary point:** Position of the binary point in the fixed-point output.
 - **Floating-point Precision:**
 - **Single:** Specifies single precision (32 bits).
 - **Double:** Specifies double precision (64 bits).
 - **Custom:** This block is listed in the following: Activates the field below so you can specify the Exponent width and the Fraction width.
 - **Exponent width:** Specify the exponent width.
 - **Fraction width:** Specify the fraction width.
- **Rate:**
 - **Assert rate:** specifies whether or not the block will assert that the rate at its input is the same as the rate specified. If the rates are not the same, an error message is reported.
 - **Specify rate:** Specifies whether or not the initial rate to assert is provided from a signal connected to an input port named `rate`, or whether it is specified **Explicitly** from the **Sample rate** parameter in the Assert block dialog box.
 - **Provide output port:** Specifies whether or not the block will feature an output port. The type and/or rate of the signal presented on the output port is the type and/or rate specified for assertion.

Other parameters used by this block are explained in the topic [Common Options in Block Parameter Dialog Boxes](#).

The **Output type** parameter in this block uses the same description as the Arithmetic Type described in the topic [Common Options in Block Parameter Dialog Boxes](#).

The Assert block does not use a Xilinx LogiCORE™ and does not use resources when implemented in hardware.

Using the Assert block to Resolve Rates and Types

In cases where the simulation engine cannot resolve rates or types, the Assert block can be used to force a particular type or rate. In general this might be necessary when using components that use feedback and act as a signal source. For example, the circuit below requires an Assert block to force the rate and type of an SRL16. In this case, you can use an Assert block to 'seed' the rate which is then propagated back to the SRL16 input through the SRL16 and back to the Assert block. The design below fails with the following message when the Assert block is not used.

The data types could not be established for the feedback paths through this block. You might need to add Assert blocks to instruct the system how to resolve types.

Figure 3: Addressable Shift Register

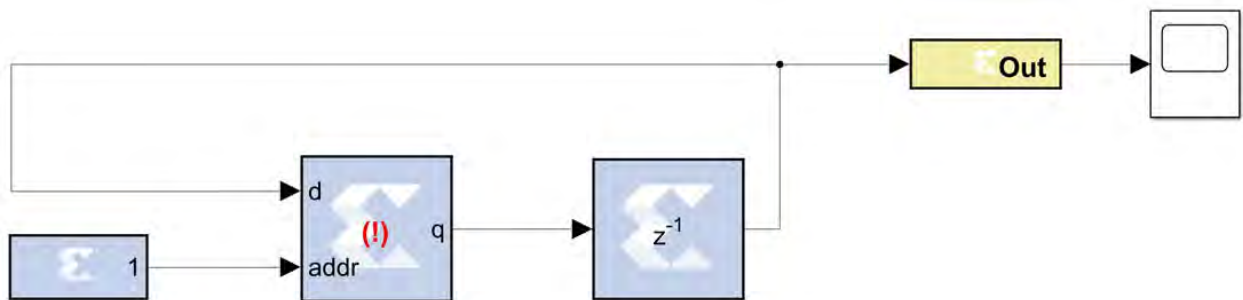

To resolve this error, an Assert block is introduced in the feedback path as shown below:

Figure 4: Addressable Shift Register with Assert Block

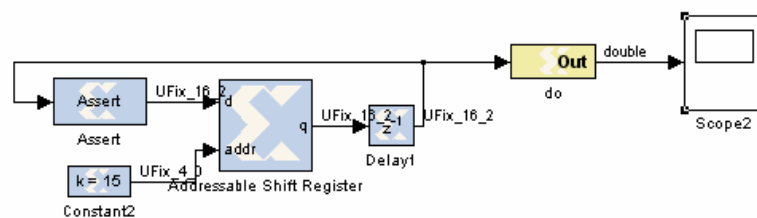

In the example, the Assert block is required to resolve the type, but the rate could have been determined by assigning a rate to the constant clock. The decision whether to use Constant blocks or Assert blocks to force rates is arbitrary and can be determined on a case by case basis.

System Generator 8.1 and later now resolves rates and types deterministically, however in some cases, the use of Assert blocks might be necessary for some System Generator components, even if they are resolvable. These blocks might include Black Box components and certain IP blocks.

AXI FIFO

This block is listed in the following Xilinx Blockset libraries: Control Logic, Floating-Point, Memory, and Index.

The Xilinx AXI FIFO block implements a FIFO memory queue with an AXI-compatible block interface.



Block Interface

- **Write Channel:**
 - **tready:** Indicates that the slave can accept a transfer in the current cycle.
 - **tvalid:** Indicates that the master is driving a valid transfer. A transfer takes place when both tvalid and tready are asserted.
 - **tdata:** The primary input data channel.
- **Read Channel:**
 - **tdata:** The primary output for the data.
 - **tready:** Indicates that the slave can accept a transfer in the current cycle.
 - **tvalid:** Indicates that the slave is accepting a valid transfer. A transfer takes place when both tvalid and tready are asserted.

Block Parameters

The block parameters dialog box can be invoked by double-clicking the icon in your Simulink® model.

- **Basic tab:**

Parameters specific to the Basic tab are as follows.

 - **Data Port Parameters:**
 - **FIFO depth:** Specifies the number of words that can be stored. Range 16-128K.

- **Actual FIFO depth:** A report field that indicates the actual FIFO depth. The actual depth of the FIFO depends on its implementation and the features that influence its implementation.
- **Optional Ports:**
 - **TDATA:** The primary payload that is used to provide the data that is passing across the interface. The width of the data payload is an integer number of bytes.
 - **TDEST:** Provides routing information for the data stream.
 - **TSTRB:** The byte qualifier that indicates whether the content of the associated byte of TDATA is processed as a data byte or a position byte. For a 64-bit DATA, bit 0 corresponds to the least significant byte on DATA, and bit 7 corresponds to the most significant byte. For example:
 - STROBE[0] = 1b, DATA[7:0] is valid
 - STROBE[7] = 0b, DATA[63:56] is not valid
 - **TREADY:** Indicates that the slave can accept a transfer in the current cycle.
 - **TID:** The data stream identifier that indicates different streams of data.
 - **TUSER:** The user-defined sideband information that can be transmitted alongside the data stream.
 - **TKEEP:** The byte qualifier that indicates whether the content of the associated byte of TDATA is processed as part of the data stream. Associated bytes that have the TKEEP byte qualifier de-asserted are null bytes and can be removed from the data stream. For a 64-bit DATA, bit 0 corresponds to the least significant byte on DATA, and bit 7 corresponds to the most significant byte. For example:
 - KEEP[0] = 1b, DATA[7:0] is a NULL byte
 - KEEP [7] = 0b, DATA[63:56] is not a NULL byte
 - **TLAST:** Indicates the boundary of a packet.
 - **arestn:** Adds arestn (global reset) port to the block.
- **Data Threshold Parameters:**
 - **Provide FIFO occupancy DATA counts:** Adds data_count port to the block. This port indicates the number of words written into the FIFO. The count is guaranteed to never under-report the number of words in the FIFO, to ensure the user never overflows the FIFO. The exception to this behavior is when a write operation occurs at the rising edge of write clock; that write operation will only be reflected on WR_DATA_COUNT at the next rising clock edge. $D = \log_2(\text{FIFO depth}) + 1$
- **Implementation tab:** FIFO Options

- FIFO implementation type:** Specifies how the FIFO is implemented in the FPGA. Possible options are: Common Clock block RAM and Common Clock Distributed RAM. The XPM_FIFO_AXIS macro will be inferred or implemented when the design is compiled. For information on the XPM_FIFO_AXIS Xilinx Parameterized Macro (XPM), refer to *UltraScale Architecture Libraries Guide (UG974)*.

Other parameters used by this block are explained in the topic [Common Options in Block Parameter Dialog Boxes](#).

BitBasher

This block is listed in the following Xilinx® Blockset libraries: Basic Elements, Data Types, and Index.

The Xilinx BitBasher block performs slicing, concatenation and augmentation of inputs attached to the block.

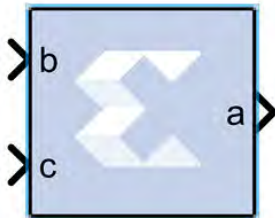

The operation to be performed is described using Verilog syntax which is detailed in this document. The block can have up to four output ports. The number of output ports is equal to the number of expressions. The block does not cost anything in hardware.

Block Parameters

The block parameters dialog box can be invoked by double-clicking the icon in your Simulink® model.

- Basic tab:** Parameters specific to the Basic tab are as follows.
 - BitBasher Expression:** Bitwise manipulation expression based on Verilog Syntax. Multiple expressions (limited to a maximum of 4) can be specified using new line as a separator between expressions.
- Output Type tab:**
 - Output:** This refers to the port on which the data type is specified.
 - Output type:** Arithmetic type to be forced onto the corresponding output.
 - Binary Point:** Binary point location to be forced onto the corresponding output.

Other parameters used by this block are explained in the topic [Common Options in Block Parameter Dialog Boxes](#).

Supported Verilog Constructs

The BitBasher block only supports a subset of Verilog expression constructs that perform bitwise manipulations including slice, concatenation, and repeat operators. All specified expressions must adhere to the following template expression:

```
output_var = {bitbasher_expr}
```

bitbasher_expr: A slice, concat or repeat expression based on Verilog syntax or simply an input port identifier.

output_var: The output port identifier. An output port with the name `output_var` will appear on the block and will hold the result of the wire expression `bitbasher_expr`.

Concat

```
output_var = {bitbasher_expr1, bitbasher_expr2, bitbasher_expr3}
```

The concat syntax is supported as shown above. Each of `bitbasher_exprN` could either be an expression or simply an input port identifier.

The following are some examples of this construct:

```
a1 = {b,c,d,e,f,g}
a2 = {e}
a3 = {b,{f,c,d},e}
```

Slice

```
output_var = {port_identifier[bound1:bound2]}(1)
output_var = {port_identifier[bitN]}(2)
```

port_identifier: The input port from which the bits are extracted.

bound1, bound2: Non-negative integers that lie between 0 and (bit-width of `port_identifier` - 1)

bitN: Non-negative integers that lie between 0 and (bit-width of `port_identifier` - 1)

As shown above, there are two schemes to extract bits from the input ports. If a range of consecutive bits need to be extracted, then the expression of the following form should be used.

```
output_var = {port_identifier[bound1:bound2]}(1)
```

If only one bit is to be extracted, then the alternative form should be used.

`output_var = {port_identifier[bitN]}(2)`

The following are some examples of this construct:

```
a1 = {b[7:3]}
```

a1 holds bits 7 through 3 of input b in the same order in which they appear in bit b (for example, if b is 110110110 then a1 is 10110).

```
a2 = {b[3:7]}
```

a2 holds bits 7 through 3 of input b in the reverse order in which they appear in bit b (for example, if b is 110100110 then a2 is 00101).

```
a3 = {b[5]}
```

a3 holds bit 5 of input b.

```
a4 = {b[7:5],c[3:9],{d,e}}
```

The above expression makes use of a combination of slice and concat constructs. Bits 7 through 5 of input b, bits 3 through 9 of input c and all the bits of d and e are concatenated.

Repeat

```
output_var = {N{bitbasher_expr}}
```

N: A positive integer that represents the repeat factor in the expression

The following are some examples of this construct:

```
a1 = {4{b[7:3]}}
```

The above expression is equivalent to `a1 = {b[7:3], b[7:3], b[7:3], b[7:3]}`

```
a2 = {b[7:3],2{c,d}}
```

The above expression is equivalent to `a2 = {b[7:3],c,d,c,d}`

Constants

Binary Constant: `N'bbin_const`

Octal Constant: `N'ooctal_const`

Decimal Constant: N'doctal_const

Hexadecimal Constant: N'hoctal_const

N: A positive integer that represents the number of bits that are used to represent the constant

bin_const: A legal binary number string made up of 0 and 1

octal_const: A legal octal number string made up of 0, 1, 2, 3, 4, 5, 6 and 7

decimal_const: A legal decimal number string made up of 0, 1, 2, 3, 4, 5, 6, 7, 8 and 9

hexadecimal_const: A legal binary number string made up of 0, 1, 2, 3, 4, 5, 6, 7, 8, 9, a, b, c, d, e and f

A constant can only be used to augment expressions already derived from input ports. In other words, a BitBasher block cannot be used to simply source constant like the [Constant](#) block.

The following examples make use of this construct:

```
a1 = {4'b1100, e}
```

if e were 110110110 then a1 would be 1100110110110.

```
a1 = {4'hb, e}
```

if e were 110110110 then a1 would be 1101110110110.

```
a1 = {4'o10, e}
```

if e were 110110110 then a1 would be 1000110110110.

Limitations

- Does not support masked parameterization on the bitbasher expressions.
- An expression cannot contain only constants, that is, each expression must include at least one input port.

Black Box

This block is listed in the following Xilinx® Blockset libraries: Basic Elements, Control Logic, Floating-Point, and Index.

The System Generator Black Box block provides a way to incorporate hardware description language (HDL) models into System Generator.



The block is used to specify both the simulation behavior in Simulink and the implementation files to be used during code generation with System Generator. A black box's ports produce and consume the same sorts of signals as other System Generator blocks. When a black box is translated into hardware, the associated HDL entity is automatically incorporated and wired to other blocks in the resulting design.

The black box can be used to incorporate either VHDL or Verilog into a Simulink model. Black box HDL can be co-simulated with Simulink using the System Generator interface to the Vivado® simulator.

In addition to incorporating HDL into a System Generator model, the black box can be used to define the implementation associated with an external simulation model.

Requirements on HDL for Black Boxes

Every HDL component associated with a black box must adhere to the following System Generator requirements and conventions:

- The entity name must not collide with any entity name that is reserved by System Generator (e.g., `xlfir`, `xlregister`).
- Bi-directional ports are supported in HDL black boxes; however they will not be displayed in the System Generator as ports, they will only appear in the generated HDL after netlisting.
- For a Verilog Black Box, the module and port names must be lower case, and follow standard Verilog naming conventions.
- For a VHDL Black Box, the supported port data types are `std_logic` and `std_logic_vector`.
- Top level ports should be ordered most significant bit down to least significant bit, as in `std_logic_vector(7 downto 0)`, and not `std_logic_vector(0 to 7)`.
- Top level ports with signed binary types in Verilog RTL are not supported (for example, `18' sb1010`). Only unsigned binary types are supported.
- Clock and clock enable ports must be named according to the conventions described below.
- Any port that is a clock or clock enable must be of type `std_logic`. (For Verilog black boxes, such ports must be non-vector inputs, e.g., `input clk`.)

- Clock and clock enable ports on a black box are not treated like other ports. When a black box is translated into hardware, System Generator drives the clock and clock enable ports with signals whose rates can be specified according to the block's configuration and the sample rates that drive it in Simulink.
- Falling-edge triggered output data cannot be used.



IMPORTANT! System Generator does not import `.dcp` files as an IP for blackbox flows.

To understand how clocks work for black boxes, it helps to understand how System Generator handles Timing and Clocking. In general, to produce multiple rates in hardware, System Generator uses a single clock along with multiple clock enables, one enable for each rate. The enables activate different portions of hardware at the appropriate times. Each clock enable rate is related to a corresponding sample period in Simulink. Every System Generator block that requires a clock has at least one clock and clock enable port in its HDL counterpart. Blocks having multiple rates have additional clock and clock enable ports.

Clocks for black boxes work like those for other System Generator blocks. The black box HDL must have a separate clock and clock enable port for each associated sample rate in Simulink. Clock and clock enable ports in black box HDL should be expressed as follows:

- Clock and clock enables must appear as pairs (for example, for every clock, there is a corresponding clock enable, and vice-versa). Although a black box can have more than one clock port, a single clock source is used to drive each clock port. Only the clock enable rates differ.
- Each clock name (respectively, clock enable name) must contain the substring `clk` (resp., `ce`).
- The name of a clock enable must be the same as that for the corresponding clock, but with `ce` substituted for `clk`. For example, if the clock is named `src_clk_1`, then the clock enable must be named `src_ce_1`.

Clock and clock enable ports are not visible on the black box block icon. A work around is required to make the top-level HDL clock enable port visible in System Generator; the work around is to add a separate enable port to the top-level HDL and AND this signal with the actual clock enable signal.

The Black Box Configuration Wizard

The Configuration Wizard is a tool that makes it easy to associate a Verilog or VHDL component to a black box. The wizard is invoked whenever a black box is added to a model.



IMPORTANT! To use the wizard, copy the `.v` or `.vhd` file that defines the HDL component for a black box into the directory that contains the model.

When a new black box is added to a model, the Configuration Wizard opens automatically. An example is shown in the figure below.

Figure 5: Black Box Configuration Wizard Example

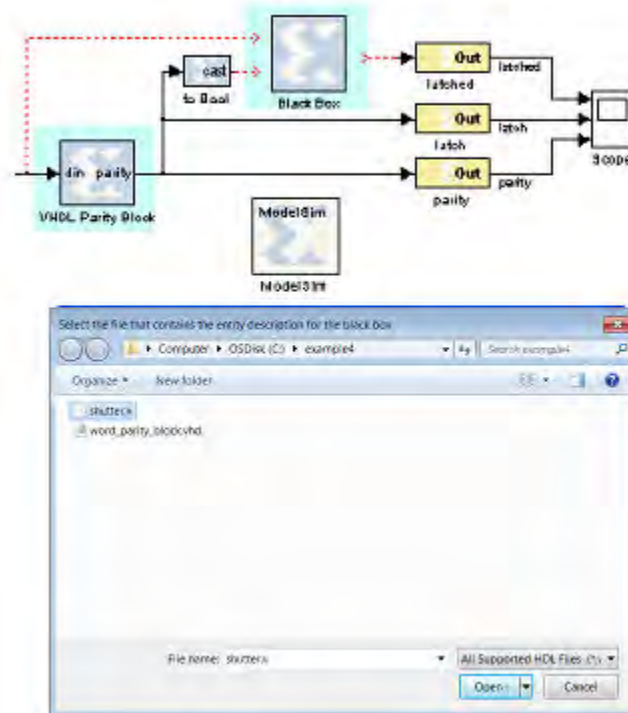

From this wizard choose the HDL file that should be associated to the black box, then press the **Open** button. The wizard generates a configuration M-function (described below) for the black box, and associates the function with the block. The configuration M-function produced by the wizard can usually be used without change, but occasionally the function must be tailored by hand. Whether the configuration M-function needs to be modified depends on how complex the HDL is.

The Black Box Configuration M-Function

A black box must describe its interface (e.g., ports and generics) and its implementation to System Generator. It does this through the definition of a MATLAB M-function (or p-function) called the block's configuration. The name of this function must be specified in the block parameter dialog box under the Block Configuration parameter.

The configuration M-function does the following:

- It specifies the top-level entity name of the HDL component that should be associated with the black box.
- It selects the language (for example, VHDL or Verilog).
- It describes ports, including type, direction, bit width, binary point position, name, and sample rate. Ports can be static or dynamic. Static ports do not change; dynamic ports change in response to changes in the design. For example, a dynamic port might vary its width and type to suit the signal that drives it.

- It defines any necessary port type and data rate checking.
- It defines any generics required by the black box HDL.
- It specifies the black box HDL and other files (e.g., EDIF) that are associated with the block.
- It defines the clocks and clock enables for the block (see the following topic on clock conventions).
- It declares whether the HDL has any combinational feed-through paths.

System Generator provides an object-based interface for configuring black boxes consisting of two types of objects: System Generator BlockDescriptors, used to define entity characteristics, and System Generator PortDescriptors, used to define port characteristics. This interface is used to provide System Generator information in the configuration M-function for black box about the block's interface, simulation model, and implementation.

If the HDL for a black box has at least one combinational path (for example, a direct feed-through from an input to an output port), the block must be tagged as combinational in its configuration M-function using the `tagAsCombinational` method. A black box can be a mixture (for example, some paths can be combinational while others are not).



IMPORTANT! *It is essential that a block containing a combinational path be tagged as such. Doing so allows System Generator to identify such blocks to the Simulink simulator. If this is not done, simulation results are incorrect.*

The configuration M-function for a black box is invoked several times when a model is compiled. The function typically includes code that depends on the block's input ports. For example, sometimes it is necessary to set the data type and/or rate of an output port based on the attributes on an input port. It is sometimes also necessary to check the type and rate on an input port. At certain times when the function is invoked, Simulink might not yet know enough for such code to be executed.

To avoid the problems that arise when information is not yet known (in particular, exceptions), BlockDescriptor members `inputTypesKnown` and `inputRatesKnown` can be used. These are used to determine if Simulink is able, at the moment, to provide information about the input port types and rates respectively. The following code illustrates this point.

```
if (this_block.inputTypesKnown)
% set dynamic output port types
% set generics that depend on input port types
% check types of input ports
end
```

If all input rates are known, this code sets types for dynamic output ports, sets generics that depend on input port types, and verifies input port types are appropriate. Avoid the mistake of including code in these conditional blocks (e.g., a variable definition) that is needed by code outside of the conditional block.

Note that the code shown above uses an object named `this_block`. Every black box configuration M-function automatically makes `this_block` available through an input argument. In MATLAB, `this_block` is the object that represents the black box, and is used inside the configuration M-function to test and configure the black box. Every `this_block` object is an instance of the `SysgenBlockDescriptor` MATLAB class. The methods that can be applied to `this_block` are specified in Appendix A. A good way to generate example configuration M-function is to run the Configuration Wizard (described below) on simple VHDL entities.

Sample Periods

The output ports, clocks, and clock enables on a black box must be assigned sample periods in the configuration M-function. If these periods are dynamic, or the black box needs to check rates, then the function must obtain the input port sample periods. Sample periods in the black box are expressed as integer multiples of the system rate as specified by the *Simulink System Period* field on the System Generator token. For example, if the *Simulink System Period* is $1/8$, and a black box input port runs at the system rate (for example, at $1/8$), then the configuration M-function sees 1 reported as the port's rate. Likewise, if the *Simulink System Period* is specified as π , and an output port should run four times as fast as the system rate (for example, at $4*\pi$), then the configuration M-function should set the rate on the output port to 4. The appropriate rate for constant ports is Inf.

As an example of how to set the output rate on each output port, consider the following code segment:

```
block.output(1).setRate(theInputRate);
block.output(2).setRate(theInputRate*5);
block.output(3).setRate(theInputRate*5);
```

The first line sets the first output port to the same rate as the input port. The next two lines set the output rate to 5 times the rate of the input.

Block Parameters

The block parameters dialog box can be invoked by double-clicking the icon in your Simulink model.

- **Basic tab** : Parameters specific to the Basic tab are as follows.
 - **Block Configuration M-Function**: Specifies the name of the configuration M-function that is associated to the black box. Ordinarily the file containing the function is stored in the directory containing the model, but it can be stored anywhere on the MATLAB path. Note that MATLAB limits all function names (including those for configuration M-functions) to 63 characters. Do not include the file extension (".m" or ".p") in the edit box.

- Simulation Mode:** Tells the mode (Inactive, Vivado Simulator, or External co-simulator) to use for simulation. When the mode is Inactive, the black box ignores all input data and writes zeroes to its output ports. Usually for this mode the black box should be coupled, using a Configurable Subsystem.

System Generator uses Configurable Subsystems to allow two paths to be identified – one for producing simulation results, and the other for producing hardware. This approach gives the best simulation speed, but requires that a simulation model be constructed. When the mode is Vivado Simulator or External co-simulator, simulation results for the black box are produced using co-simulation on the HDL associated with the black box. When the mode is External co-simulator, it is necessary to add a ModelSim HDL co-simulation block to the design, and to specify the name of the ModelSim block in the field labeled HDL Co-Simulator To Use. An example is shown below:

Figure 6: Use of Configurable Subsystems Example

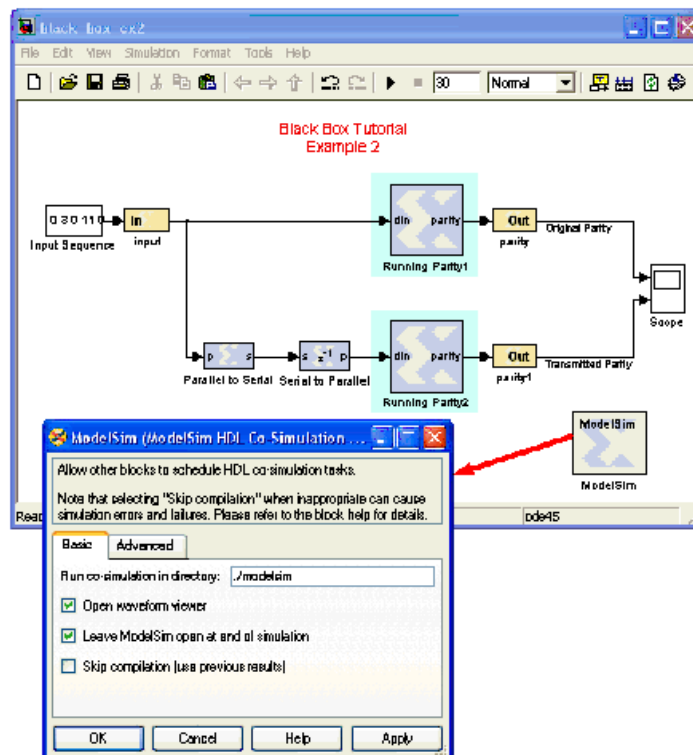

System Generator supports the ModelSim simulator from Mentor Graphics®, Inc. for HDL co-simulation. For co-simulation of Verilog black boxes, a mixed mode license is required. This is necessary because the portion of the design that System Generator writes is VHDL.

Note: When you use the ModelSim simulator, the DefaultRadix used is Binary.

Usually the co-simulator block for a black box is stored in the same Subsystem that contains the black box, but it is possible to store the block elsewhere. The path to a co-simulation block can be absolute, or can be relative to the Subsystem containing the black box (e.g., "../ModelSim"). When simulating, each co-simulator block uses one license. To avoid running out of licenses, several black boxes can share the same co-simulation block. System Generator automatically generates and uses the additional VHDL needed to allow multiple blocks to be combined into a single ModelSim simulation.

Data Type Translation for HDL Co-Simulation

During co-simulation, ports in System Generator drive ports in the HDL simulator, and vice-versa. Types of signals in the tools are not identical, and must be translated. The rules used for translation are the following.

- A signal in System Generator can be Boolean, unsigned or signed fixed point. Fixed-point signals can have indeterminate values, but Boolean signals cannot. If the signal's value is indeterminate in System Generator, then all bits of the HDL signal become 'X', otherwise the bits become 0's and 1's that represent the signal's value.
- To bring HDL signals back into System Generator, standard logic types are translated into Booleans and fixed-point values as instructed by the black box configuration M-function. When there is a width mismatch, an error is reported. Indeterminate signals of all varieties (weak high, weak low, etc.) are translated to System Generator indeterminates. Any signal that is partially indeterminate in HDL simulation (e.g., a bit vector in which only the topmost bit is indeterminate) becomes entirely indeterminate in System Generator.
- HDL to System Generator translations can be tailored by adding a custom simulation-only top-level wrapper to the VHDL component. Such a wrapper might, for example, translate every weak low signal to 0 or every indeterminate signal to 0 or 1 before it is returned to System Generator.

Example

The following is an example VHDL entity that can be associated to a System Generator black box.

```

library IEEE;
use IEEE.std_logic_1164.all;
use IEEE.numeric_std.all;
entity word_parity_block is
    generic (width : integer := 8);
    port (din : in std_logic_vector(width-1 downto 0);
          parity : out std_logic);
end word_parity_block;
architecture behavior of word_parity_block is
begin
    WORD_PARITY_Process : process (din)
        variable partial_parity : std_logic := '0';
    begin
        partial_parity := '0';
        XOR_BIT_LOOP: for N in din'range loop
    
```

```

partial_parity := partial_parity xor din(N);
end loop; -- N
parity <= partial_parity after 1 ns ;
end process WORD_PARITY_Process;
end behavior;
    
```

The following is an example configuration M-function. It makes the VHDL shown above available inside a System Generator black box.

```

function word_parity_block_config(this_block)
this_block.setTopLevelLanguage('VHDL');
    this_block.setEntityName('word_parity_block');
    this_block.tagAsCombinational;
    this_block.addSimulinkInport('din');
    this_block.addSimulinkOutport('parity');
    parity = this_block.port('parity');
    parity.setWidth(1);
    parity.useHDLVector(false);
    % -----
    if (this_block.inputTypesKnown)
    this_block.addGeneric('width',
    this_block.port('din').width);
    end % if(inputTypesKnown)
    % -----
    % -----
    if (this_block.inputRatesKnown)
    din = this_block.port('din');
    parity.setRate(din.rate);
    end % if(inputRatesKnown)
    % -----
    this_block.addFile('word_parity_block.vhd');
    return;
    
```

CIC Compiler 4.0

This block is listed in the following Xilinx® Blockset libraries: AXI4, DSP, and Index.

The Xilinx CIC Compiler provides the ability to design and implement AXI4-Stream-compliant Cascaded Integrator-Comb (CIC) filters for a variety of Xilinx FPGA devices.

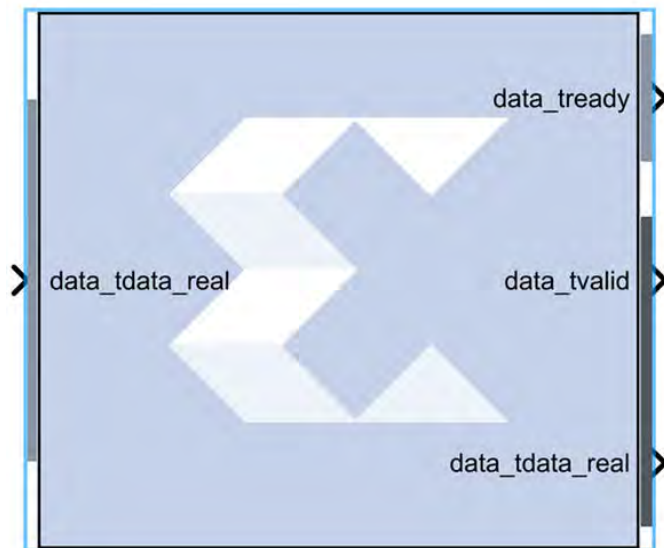

CIC filters, also known as Hogenauer filters, are multi-rate filters often used for implementing large sample rate changes in digital systems. They are typically employed in applications that have a large excess sample rate. That is, the system sample rate is much larger than the bandwidth occupied by the processed signal as in digital down converters (DDCs) and digital up converters (DUCs). Implementations of CIC filters have structures that use only adders, subtractors, and delay elements. These structures make CIC filters appealing for their hardware-efficient implementations of multi-rate filtering.

Sample Rates and the CIC Compiler Block

The CIC Compiler block must always run at the system rate because the CIC Compiler block has a programmable rate change option and Simulink® cannot inherently support it. You should use the "ready" output signal to indicate to downstream blocks when a new sample is available at the output of the CIC Compiler block.

The CIC will downsample the data, but the sample rate will remain at the clock rate. If you look at the output of the CIC Compiler block, you will see each output data repeated R times for a rate change of R while the `data_tvalid` signal pulses once every R cycles. The downstream blocks can be clocked at lower-than-system rates without any problems as long as the clock is never slower than the rate change R .

There are several different ways this can be handled. You can leave the entire design running at the system rate then use registers with enables, or enables on other blocks to capture data at the correct time. Or alternatively, you can use a downsample block corresponding to the lowest rate change R , then again use enable signals to handle the cases when there are larger rate changes.

If there are not many required rate changes, you can use MUX blocks and use a different downsample block for each different rate change. This might be the case if the downstream blocks are different depending on the rate change, basically creating different paths for each rate. Using enables as described above will probably be the most efficient method.

If you are not using the CIC Compiler block in a programmable mode, you can place an up/down sample block after the CIC Compiler to correctly pass on the sample rate to downstream blocks that will inherit the rate and build the proper CE circuitry to automatically enable those downstream blocks at the new rate.

Block Parameters

- **Filter Specification tab:** Parameters specific to the Filter Specification tab are as follows.
 - **Filter Specification:**
 - **Filter Type:** The CIC core supports both interpolation and decimation architectures. When the filter type is selected as decimator the input sample stream is down-sampled by the factor R . When an interpolator is selected the input sample is up-sampled by R .
 - **Number of Stages:** Number of integrator and comb stages. If N stages are specified, there are N integrators and N comb stages in the filter. The valid range for this parameter is 3 to 6.
 - **Differential Delay:** Number of unit delays employed in each comb filter in the comb section of either a decimator or interpolator. The valid range of this parameter is 1 or 2.
 - **Number of Channels:** Number of channels to support in implementation. The valid range of this parameter is 1 to 16.
 - **Sample Rate Change Specification:**
 - **Sample Rate Changes:** Option to select between Fixed or Programmable.
 - **Fixed or Initial Rate(ir):** Specifies initial or fixed sample rate change value for the CIC. The valid range for this parameter is 4 to 8192.
 - **Minimum Rate:** The minimum rate change value for programmable rate change. The valid range for this parameter is 4 to fixed rate (ir).
 - **Maximum Rate:** The maximum rate change value for programmable rate change. The valid range for this parameter is fixed rate (ir) to 8192.
 - **Hardware Oversampling Specification:**
 - **Select format:** Choose Maximum_Possible, Sample_Period, or Hardware Oversampling Rate. Selects which method is used to specify the hardware oversampling rate. This value directly affects the level of parallelism of the block implementation and resources used. When “Maximum Possible” is selected, the block uses the maximum oversampling given the sample period of the signal connected to the Data field of the `s_axis_data_tdata` port. When you select “Hardware Oversampling Rate”, you can specify the oversampling rate. When “Sample Period” is selected, the block clock is connected to the system clock and the value specified for the Sample Period parameter sets the input sample rate the block supports. The Sample Period parameter also determines the hardware oversampling rate of the block. When “Sample Period” is selected, the block is forced to use the `s_axis_data_tvalid` control port.

- **Sample period:** Integer number of clock cycles between input samples. When the multiple channels have been specified, this value should be the integer number of clock cycles between the time division multiplexed input sample data stream.
- **Hardware Oversampling Rate:** Enter the hardware oversampling rate if you select `Hardware_Oversampling_Rate` as the format.
- **Implementation tab:**
 - **Numerical Precision:**
 - **Quantization:** Can be specified as `Full_Precision` or `Truncation`.
Note: Truncation occurs at the output stage only.
 - **Output Data Width:** Can be specified up to 48 bits for the `Truncation` option above.
 - **Optional:**
 - **Use Xtreme DSP slice:** This field specifies that if possible, use the XtremeDSP slice (DSP48 type element) in the target device.
 - **Use Streaming Interface:** Specifies whether or not to use a streaming interface for multiple channel implementations.
 - **Control Options:**
 - **ACLKEN:** Specifies if the block has a clock enable port (the equivalent of selecting the `Has ACLKEN` option in the CORE Generator GUI).
 - **ARESETn:** Specifies that the block has a reset port. Active-Low synchronous clear. A minimum `ARESETn` pulse of two cycles is required.
 - **Has TREADY:** Specifies if the block has a `TREADY` port for the Data Output Channel (the equivalent of selecting the `Has_DOUT_TREADY` option in the CORE Generator GUI).

Other parameters used by this block are explained in the topic [Common Options in Block Parameter Dialog Boxes](#).

LogiCORE Documentation

[LogiCORE IP CIC Compiler 4.0](#)

Clock Enable Probe

This block is listed in the following Xilinx® Blockset libraries: Basic Elements and Index.

The Xilinx Clock Enable (CE) Probe provides a mechanism for extracting derived clock enable signals from Xilinx signals in System Generator models.



The probe accepts any Xilinx signal type as input, and produces a Bool output signal. The Bool output can be used at any point in the design where Bools are acceptable. The probe output is a cyclical pulse that mimics the behavior of an ideal clock enable signal used in the hardware implementation of a multirate circuit. The frequency of the pulse is derived from the input signal's sample period. The enable pulse is asserted at the end of the input signal's sample period for the duration of one Simulink® system period. For signals with a sample period equal to the Simulink system period, the block's output is always one.

Shown below is an example model with an attached analysis scope that demonstrates the usage and behavior of the Clock Enable Probe. The Simulink system sample period for the model is specified in the System Generator token as 1.0 seconds. In addition to the Simulink system period, the model has three other sample periods defined by the Down Sample blocks. Clock Enable Probes are placed after each Down Sample block and extract the derived clock enable signal. The probe outputs are run to output gateways and then to the scope for analysis. Also included in the model is CLK probe that produces a Double representation of the hardware system clock. The scope output shows the output from the four Clock Enable probes in addition to the CLK probe output.

Figure 7: Example Model with Attached Analysis Scope

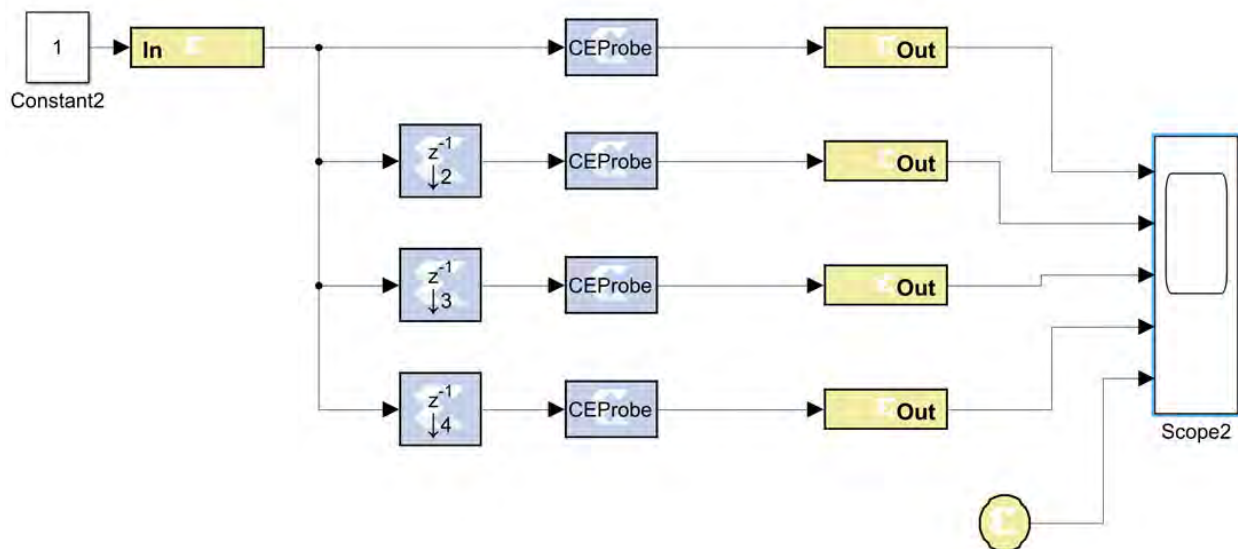
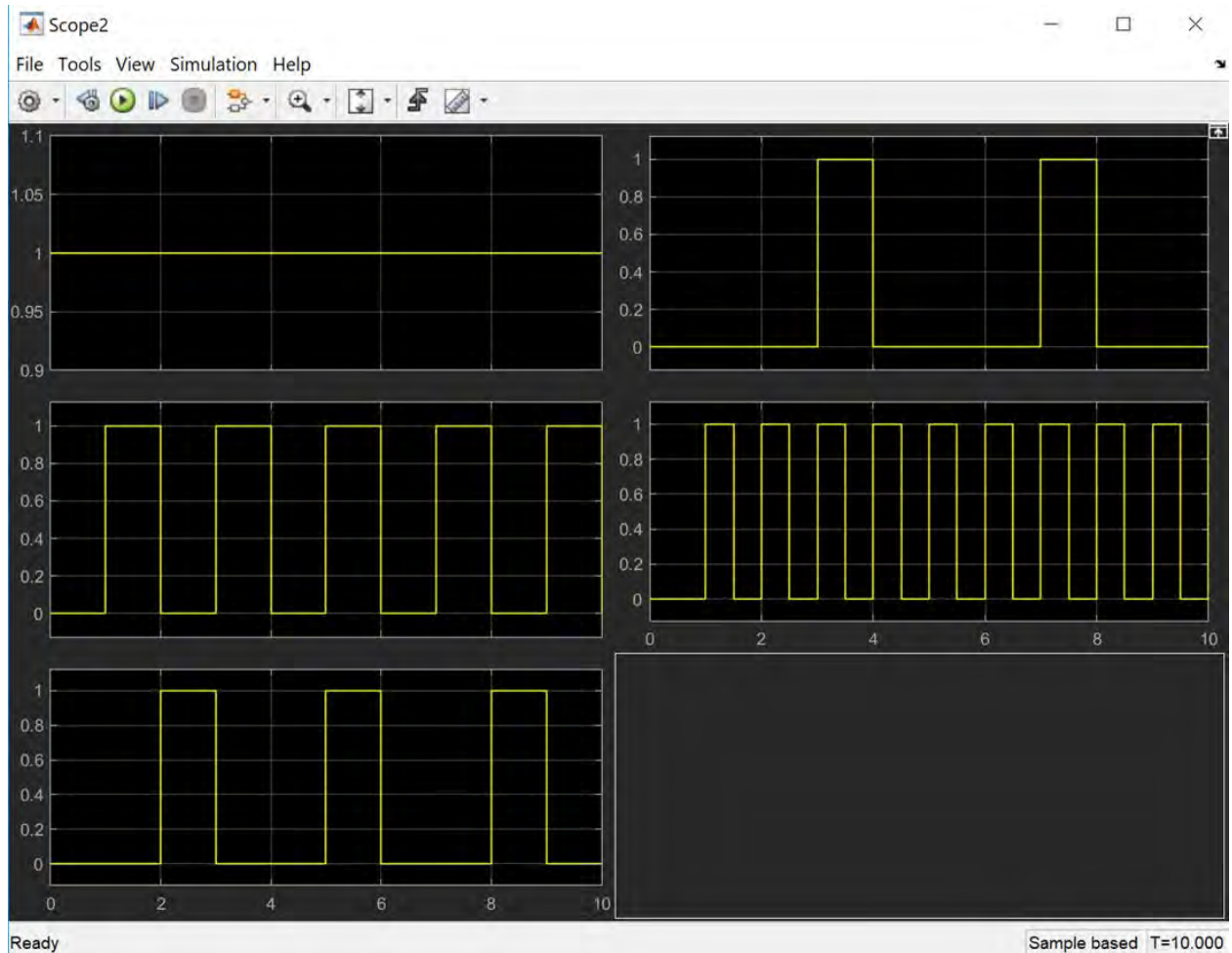

Figure 8: Analysis Scope Output



Options

- Use clock enable signal without Multi-Cycle path constraints:** Used to disable multi-cycle path constraints on the generated signal from the Clock Enable Probe block. This is typically applied when the signal being generated is used as a separate timing signal that is not clock-enable related.

Clock Probe

This block is listed in the following Xilinx® Blockset libraries: Tools and Index.

The Xilinx Clock Probe generates a double-precision representation of a clock signal with a period equal to the Simulink® system period.



The output clock signal has a 50/50 duty cycle with the clock asserted at the start of the Simulink sample period. The Clock Probe's double output is useful only for analysis, and cannot be translated into hardware.

There are no parameters for this block.

CMult

This block is listed in the following Xilinx® Blockset libraries: Math, Floating-Point, and Index.

The Xilinx CMult block implements a *gain* operator, with output equal to the product of its input by a constant value. This value can be a MATLAB® expression that evaluates to a constant.

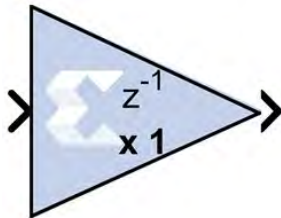

Block Parameters

The block parameters dialog box can be invoked by double-clicking the icon in your Simulink® model.

- **Basic tab:**

Parameters specific to the Basic tab are as follows:

- **Constant Type:**
 - **Fixed-point:** Use fixed-point data type.
 - **Floating-point:** Use floating-point data type. Can be a constant or an expression. If the constant cannot be expressed exactly in the specified fixed-point type, its value is rounded and saturated as needed.
- **Fixed-point Precision:**

- **Number of bits:** Specifies the bit location of the binary point of the constant, where bit zero is the least significant bit.
- **Binary point:** Position of the binary point.
- **Floating-point Precision:**
 - **Single:** Specifies single precision (32 bits)
 - **Double:** Specifies double precision (64 bits)
 - **Custom:** Activates the field below so you can specify the Exponent width and the Fraction width.
 - **Exponent width:** Specify the exponent width.
 - **Fraction width:** Specify the fraction width.
- **Output tab:**
 - **Precision:** This parameter allows you to specify the output precision for fixed-point arithmetic. Floating point arithmetic output will always be Full precision.
 - **Full:** The block uses sufficient precision to represent the result without error.
 - **User Defined:** If you do not need full precision, this option allows you to specify a reduced number of total bits and/or fractional bits.
 - **Fixed-point Output Type:**
 - **Arithmetic type:**
 - **Signed (2's comp):** The output is a Signed (2's complement) number.
 - **Unsigned:** The output is an Unsigned number.
 - **Fixed-point Precision:**
 - **Number of bits:** Specifies the bit location of the binary point of the output number, where bit zero is the least significant bit.
 - **Binary point:** Position of the binary point in the fixed-point output.
 - **Quantization:**

Refer to the section [Overflow and Quantization](#).
 - **Overflow:**

Refer to the section [Overflow and Quantization](#).
- **Implementation tab:**

Parameters specific to the Implementation tab are as follows.

- **Use behavioral HDL description (otherwise use core):** When selected, System Generator uses behavioral HDL, otherwise it uses the Xilinx LogiCORE™ Multiplier. When this option is not selected (false) System Generator internally uses the behavioral HDL model for simulation if any of the following conditions are true:
 - The constant value is 0 (or is truncated to 0).
 - The constant value is less than 0 and its bit width is 1.
 - The bit width of the constant or the input is less than 1 or is greater than 64.
 - The bit width of the input data is 1 and its data type is xFix.
- **Core Parameters:**
 - **Implement using:** Specifies whether to use distributed RAM or block RAM.
 - **Test for optimum pipelining:** Checks if the Latency provided is at least equal to the optimum pipeline length supported for the given configuration of the block. Latency values that pass this test imply that the core produced is optimized for speed.

Other parameters used by this block are explained in the topic [Common Options in Block Parameter Dialog Boxes](#).

LogiCORE Documentation

[LogiCORE IP Multiplier v12.0](#)

[LogiCORE IP Floating-Point Operator v7.1](#)

Complex Multiplier 6.0

This block is listed in the following Xilinx® Blockset libraries: AXI4, DSP, Index, and Math.

The Complex Multiplier block implements AXI4-Stream compliant, high-performance, optimized complex multipliers for devices based on user-specified options.

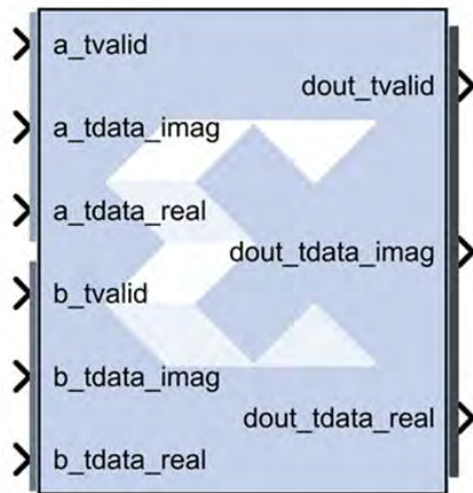

The two multiplicand inputs and optional rounding bit are input on independent AXI4-Stream channels as slave interfaces and the resulting product output using an AXI4-Stream master interface.

Within each channel, operands, and the results are represented in signed two's complement format. The operand widths, and the result width are parameterizable.

Block Parameters

- **Page 1 tab:**

Parameters specific to the Basic tab are:

- **Channel A Options:**

- **Has TLAST:** Adds a tlast input port to the A channel of the block.
- **Has TUSER:** Adds a tuser input port to the A channel of the block.
- **TUSER Width:** User defined, maximum Limit range (1, 256).

- **Channel B Options:**

- **Has TLAST:** Adds a tlast input port to the B channel of the block.
- **Has TUSER:** Adds a tuser input port to the B channel of the block.
- **TUSER Width:** User defined, maximum Limit range (1, 256).

- **Multiplier Construction Options:**

- **Use_Mults:** Use embedded multipliers/XtremeDSP slices.
- **Use_LUTs:** Use LUTs in the fabric to construct multipliers.

- **Optimization Goal:** Only available if Use_Mults is selected.
 - **Resources:** Uses the 3-real-multiplier structure. However, a 4-real-multiplier structure is used when the 3- l- multiplier structure uses more multiplier resources.
 - **Performance:** Always uses the 4-real multiplier structure to allow the best frequency performance to be achieved.
- **Flow Control Options:**
 - **Blocking:** Selects “Blocking” mode. In this mode, the lack of data on one input channel does block the execution of an operation if data is received on another input channel.
 - **NonBlocking:** Selects “Non-Blocking” mode. In this mode, the lack of data on one input channel does not block the execution of an operation if data is received on another input channel.
- **Page 2 tab:**
 - **Output Product Range:**

Select the output bit width. The values are automatically set to provide the full-precision product when the A and B operand widths are set. The output is sign-extended if required.

The natural output width for complex multiplication is $(A\text{PortWidth} + B\text{PortWidth} + 1)$. When the Output Width is set to be less than this, the most significant bits of the result are those output; the remaining bits will either be truncated or rounded according to Output Rounding option selected. That is to say, the output MSB is now fixed at $(A\text{PortWidth} + B\text{PortWidth})$. For details please refer to the document [LogiCORE IP Complex Multiplier v6.0 Product Guide](#).
 - **Output Rounding:** If rounding is required, the Output LSB must be greater than zero.
 - **Truncate:** Truncate the output.
 - **Random_Rounding:** When this option is selected, a ctrl_tvalid and ctrl_tdata input port is added to the block. Bit 0 if ctrl_tdata input determines the particular type if rounding for the operation. For details, refer to the Rounding section of the document [LogiCORE IP Complex Multiplier v6.0 Product Guide](#).
 - **Channel CTRL Options:** The following options are activated when Random Rounding is selected.
 - **Has TLAST:** Adds a ctrl_tlast input port to the block.
 - **Has TUSER:** Adds a ctrl_user input port to the block.
 - **TUSER Width:** Specifies the bit width of the ctrl_tuser input port.
 - **Output TLAST Behavior:** Determines the behavior of the dout_tlast output port.
 - **Null:** Output is null.

- **Pass_A_TLAST:** Pass the value of the a_tlast input port to the dout_tlast output port.
- **Pass_B_TLAST:** Pass the value of the b_tlast input port to the dout_tlast output port.
- **Pass_CTRL_TLAST:** Pass the value of the ctrl_tlast input port to the dout_tlast output port.
- **OR_all_TLASTS:** Pass the logical OR of all the present TLAST input ports.
- **AND_all_TLASTS:** Pass the logical AND of all the present TLAST input ports.
- **Core Latency:**
 - **Latency Configuration:**
 - **Automatic:** Block latency is automatically determined by System Generator by pipelining the underlying LogiCORE™ for maximum performance.
 - **Manual:** You can adjust the block latency specifying the minimum block latency.
 - **Minimum Latency:** Entry field for manually specifying the minimum block latency.
- **Control Signals:**
 - **ACLKEN:** Enables the clock enable (aclken) pin on the core. All registers in the core are enabled by this control signal.
 - **ARESETn:** Active-Low synchronous clear input that always takes priority over ACLKEN. A minimum ARESETn active pulse of two cycles is required, since the signal is internally registered for performance. A pulse of one cycle resets the core, but the response to the pulse is not in the cycle immediately following.
- **Advanced tab:** Block Icon Display
 - **Display shortened port names:** On by default. For example, when unchecked, **dout_tvalid** becomes **m_axis_dout_tvalid**.

LogiCORE Documentation

[LogiCORE IP Complex Multiplier v6.0](#)

Concat

This block is listed in the following Xilinx® Blockset libraries: Basic Elements, Data Types, and Index.

The Xilinx Concat block performs a concatenation of n bit vectors represented by unsigned integer numbers, for example, n unsigned numbers with binary points at position zero.

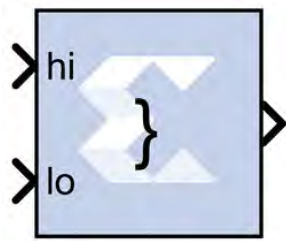

The Xilinx [Reinterpret](#) block provides capabilities that can extend the functionality of the Concat block.

Block Interface

The block has n input ports, where n is some value between 2 and 1024, inclusively, and one output port. The first and last input ports are labeled `hi` and `low`, respectively. Input ports between these two ports are not labeled. The input to the `hi` port will occupy the most significant bits of the output and the input to the `low` port will occupy the least significant bits of the output.

Block Parameters

The block parameters dialog box can be invoked by double-clicking the icon in your Simulink® model.

Parameters specific to this block are as follows:

- Number of Inputs: specifies number of inputs, between 2 and 1024, inclusively, to concatenate together.

Other parameters used by this block are explained in the topic [Common Options in Block Parameter Dialog Boxes](#).

The Concat block does not use a Xilinx LogiCORE.

Constant

This block is listed in the following Xilinx® Blockset libraries: Basic Elements, Control Logic, Math, Floating-Point and Index.

The Xilinx Constant block generates a constant that can be a fixed-point value, or a Boolean value. This block is similar to the Simulink® constant block, but can be used to directly drive the inputs on Xilinx blocks.



DSP48 Instruction Mode

The constant block, when set to create a DSP48 instruction, is useful for generating DSP48 control sequences. The figure below shows an example. The example implements a 35x35-bit multiplier using a sequence of four instructions in a DSP48 block. The constant blocks supply the desired instructions to a multiplexer that selects each instruction in the desired sequence.

Figure 9: Example of Constant Block Creating a DSP48 Instruction

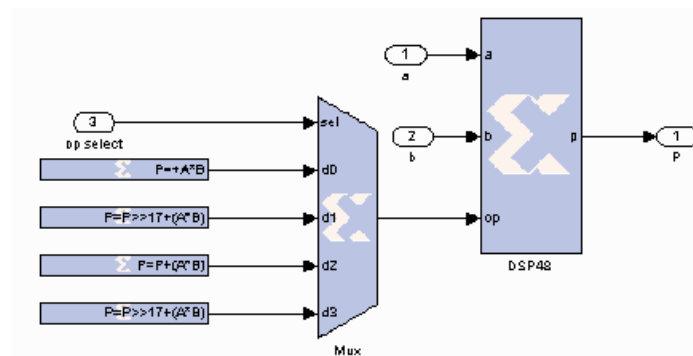

Block Parameters

The block parameters dialog box can be invoked by double-clicking the icon in your Simulink® model.

- **Basic tab:**

Parameters specific to the Basic tab are as follows:

- **Constant Value:**

Specifies the value of the constant. When changed, the new value appears on the block icon. If the constant data type is specified as fixed-point and cannot be expressed exactly in the specified fixed-point type, its value is rounded and saturated as needed. A positive value is implemented as an unsigned number, a negative value as signed.

- **Output Type:** Specifies the data type of the output. Can be Boolean, Fixed-point, or Floating-point.

- **Arithmetic Type:** If the Output Type is specified as Fixed-point, you can select **Signed (2's comp)**, **Unsigned**, or **DSP48 instruction** as the Arithmetic Type.

- **Fixed-point Precision:**
 - **Number of bits:** Specifies the bit location of the binary point of the output number, where bit zero is the least significant bit.
 - **Binary point:** Position of the binary point in the fixed-point output.
- **Floating-point Precision:**
 - **Single:** Specifies single precision (32 bits).
 - **Double:** Specifies double precision (64 bits)
 - **Custom:** Activates the field below so you can specify the Exponent width and the Fraction width.
 - **Exponent width:** Specifies the exponent width.
 - **Fraction width:** Specifies the fraction width.
- **Sample Period:**
 - **Sampled Constant:** Allows a sample period to be associated with the constant output and inherited by blocks that the constant block drives. (This is useful mainly because the blocks eventually target hardware and the Simulink sample periods are used to establish hardware clock periods.)
- **DSP48 tab:**
 - **DSP48 Instruction:** The use of this block for DSP48 instructions is deprecated. Please use the Opmode block.

Other parameters used by this block are explained in the topic [Common Options in Block Parameter Dialog Boxes](#).

Convert

This block is listed in the following Xilinx® Blockset libraries: Basic Elements, Data Types, Math, Floating-Point, and Index.

The Xilinx Convert block converts each input sample to a number of a desired arithmetic type. For example, a number can be converted to a signed (two's complement) or unsigned value.

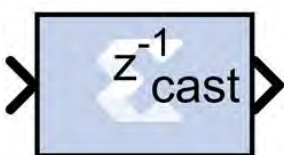

Block Parameters

The block parameters dialog box can be invoked by double-clicking the icon in your Simulink model.

- **Basic tab:** Parameters specific to the Basic Tab are as follows.
 - **Output Type:** Specify the output data type.
 - Boolean
 - Fixed-point
 - Floating-point
 - **Arithmetic Type:** If the Output Type is specified as Fixed-point, you can select Signed (2's comp) or Unsigned.
 - **Fixed-point Precision:**
 - **Number of bits:** Specifies the bit location of the binary point, where bit zero is the least significant bit.
 - **Binary point:** Specifies the bit location of the binary point.
 - **Floating-point Precision:**
 - **Single:** Specifies single precision (32 bits).
 - **Double:** Specifies double precision (64 bits).
 - **Custom:** Activates the field below so you can specify the Exponent width and the Fraction width.
 - **Exponent width:** Specify the exponent width.
 - **Fraction width:** Specify the fraction width.
 - **Quantization:**

Quantization errors occur when the number of fractional bits is insufficient to represent the fractional portion of a value. The options are to **Truncate** (for example, to discard bits to the right of the least significant representable bit), or to **Round(unbiased: +/- inf)** or **Round (unbiased: even values)**.

Round(unbiased: +/- inf) also known as "Symmetric Round (towards +/- inf)" or "Symmetric Round (away from zero)". This is similar to the MATLAB `round()` function. This method rounds the value to the nearest desired bit away from zero and when there is a value at the midpoint between two possible rounded values, the one with the larger magnitude is selected. For example, to round 01.0110 to a Fix_4_2, this yields 01.10, since 01.0110 is exactly between 01.01 and 01.10 and the latter is further from zero.

Round (unbiased: even values) also known as "Convergent Round (toward even)" or "Unbiased Rounding". Symmetric rounding is biased because it rounds all ambiguous midpoints away from zero which means the average magnitude of the rounded results is larger than the average magnitude of the raw results. Convergent rounding removes this by alternating between a symmetric round toward zero and symmetric round away from zero. That is, midpoints are rounded toward the nearest even number. For example, to round 01.0110 to a Fix_4_2, this yields 01.10, since 01.0110 is exactly between 01.01 and 01.10 and the latter is even. To round 01.1010 to a Fix_4_2, this yields 01.10, since 01.1010 is exactly between 01.10 and 01.11 and the former is even.

- **Overflow:**

Overflow errors occur when a value lies outside the representable range. For overflow the options are to **Saturate** to the largest positive/smallest negative value, to **Wrap** (for example, to discard bits to the left of the most significant representable bit), or to **Flag as error** (an overflow as a Simulink error) during simulation. **Flag as error** is a simulation only feature. The hardware generated is the same as when **Wrap** is selected.

- **Optional Ports:**

Provide enable port activates an optional enable (en) pin on the block. When the enable signal is not asserted the block holds its current state until the enable signal is asserted again or the reset signal is asserted.

- **Latency:**

The Latency value defines the number of sample periods by which the block's output is delayed. One sample period might correspond to multiple clock cycles in the corresponding FPGA implementation (for example, when the hardware is over-clocked with respect to the Simulink® model). System Generator will not perform extensive pipelining unless you select the **Pipeline for maximum performance** option (described below); additional latency is usually implemented as a shift register on the output of the block.

- **Implementation tab:** Parameters specific to the Implementation tab are as follows.

- **Performance Parameters:**

Pipeline for maximum performance: The XILINX LogiCORE can be internally pipelined to optimize for speed instead of area. Selecting this option puts all user defined latency into the core until the maximum allowable latency is reached. If the **Pipeline for maximum performance** option is *not* selected and latency is greater than zero, a single output register is put in the core and additional latency is added on the output of the core.

The **Pipeline for maximum performance** option adds the pipeline registers throughout the block, so that the latency is distributed, instead of adding it only at the end. This helps to meet tight timing constraints in the design.

Other parameters used by this block are explained in the topic [Common Options in Block Parameter Dialog Boxes](#).

LogiCORE Documentation

[LogiCORE IP Floating-Point Operator v7.1](#)

Convolution Encoder 9.0

This block is listed in the following Xilinx® Blockset libraries: AXI4, Communication, and Index.

The Xilinx® Convolution Encoder block implements an encoder for convolution codes. Ordinarily used in tandem with a Viterbi decoder, this block performs forward error correction (FEC) in digital communication systems. This block adheres to the AMBA® AXI4-Stream standard.

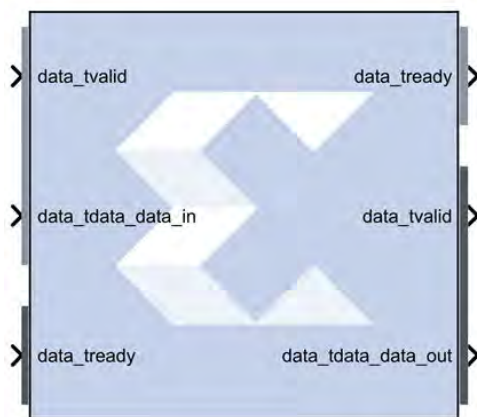

Values are encoded using a linear feed forward shift register which computes modulo-two sums over a sliding window of input data, as shown in the figure below. The length of the shift register is specified by the constraint length. The convolution codes specify which bits in the data window contribute to the modulo-two sum. Resetting the block will set the shift register to zero. The encoder rate is the ratio of input to output bit length; thus, for example a rate 1/2 encoder outputs two bits for each input bit. Similarly, a rate 1/3 encoder outputs three bits for each input bit.

Figure 10: Linear Feed Forward Shift Register

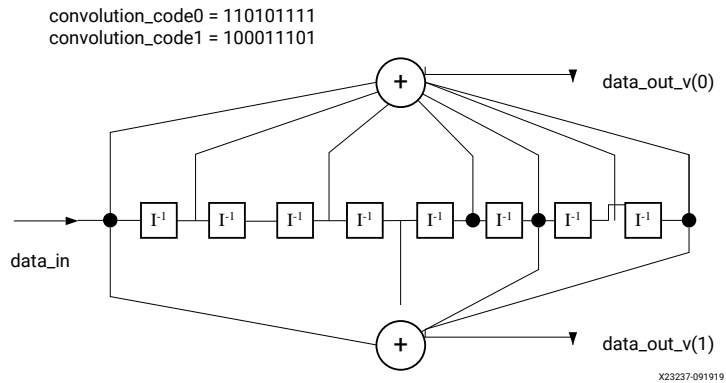

Block Parameters

The following figure shows the block parameters dialog box.

Figure 11: Block Parameters Dialog Box

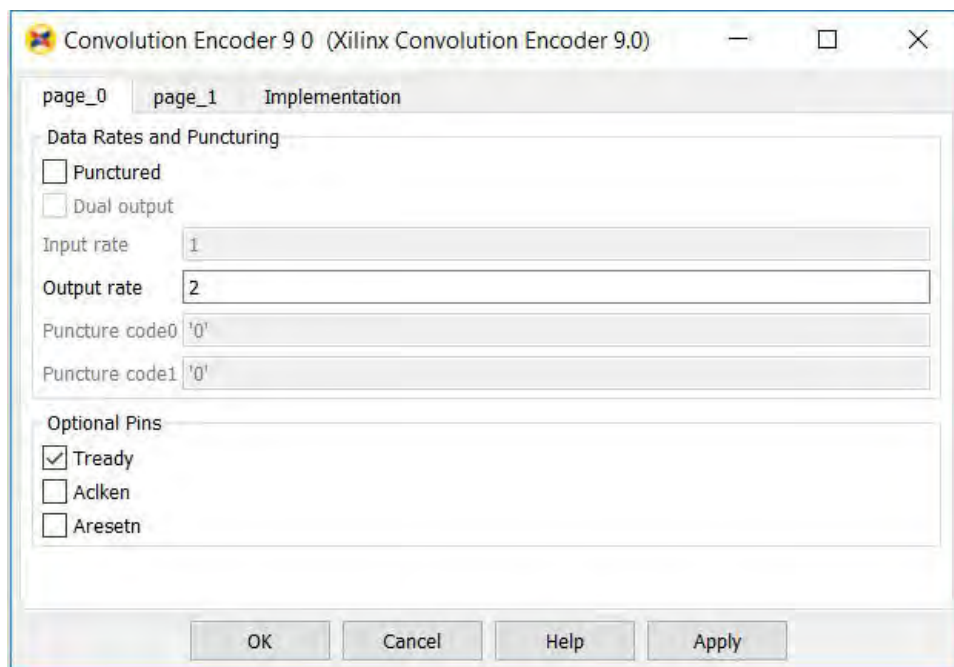

- **page_0 tab:**

Parameters specific to the page_0 tab are as follows.

- **Data Rates and Puncturing:**

- **Punctured:** Determines whether the block is punctured.

- **Dual Output:** Specifies a dual-channel punctured block.
- **Input Rate:** Punctured: Only the input rate can be modified. Its value can range from 2 to 12, resulting in a rate n/m encoder where n is the input rate and $n < m < 2n$.
- **Output Rate:** Not Punctured: Only the output rate can be modified. Its value can be integer values from 2 to 7, resulting in a rate $1/2$ or rate $1/7$ encoder, respectively
- **Puncture Code0 and Code1:** The two puncture pattern codes are used to remove bits from the encoded data prior to output. The length of each puncture code must be equal to the puncture input rate, and the total number of bits set to 1 in the two codes must equal the puncture output rate (m) for the codes to be valid. A 0 in any position indicates that the output bit from the encoder is not transmitted. See the associated LogiCORE™ data sheet for an example.
- **Optional Pins:**
 - **Tready:** Adds a **tready** pin to the block. Indicates that the slave can accept a transfer in the current cycle.
 - **Aclken:** Adds a **aclken** pin to the block. This signal carries the clock enable and must be of type Bool.
 - **Aresetn:** Adds a **aresetn** pin to the block. This signal resets the block and must be of type `Bool`. The signal must be asserted for at least 2 clock cycles, however, it does not have to be asserted before the decoder can start decoding. If this pin is not selected, System Generator ties this pin to inactive (high) on the core.
- **page_1 tab:** Parameters specific to the `page_1` tab are as follows.
 - **Radix:**
 - **Convolution code radix:** Select Binary, Octal, or Decimal.
 - **Convolution:**
 - **Constraint length:** Constraint Length: Equals $n+1$, where n is the length of the constraint register in the encoder.
 - **Convolution code:** Array of binary convolution codes. Output rate is derived from the array length. Between 2 and 7 (inclusive) codes can be entered.

Other parameters used by this block are explained in the topic [Common Options in Block Parameter Dialog Boxes](#).

LogiCORE Documentation

[LogiCORE IP Convolution Encoder 9.0](#)

CORDIC 6.0

This block is listed in the following Xilinx® Blockset libraries: DSP, Index, and Math.

The Xilinx CORDIC block implements a generalized coordinate rotational digital computer (CORDIC) algorithm and is AXI compliant.

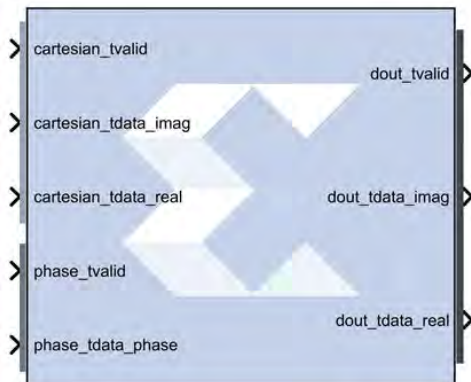

The CORDIC core implements the following equation types:

- Rotate
- Translate
- Sin_and_Cos
- Sinh_and_Cosh
- Arc_Tan
- Arc_Tanh
- Square_Root

Two architectural configurations are available for the CORDIC core:

- A word serial implementation with multiple-cycle throughput, but occupying a small silicon area.
- A fully parallel configuration with single-cycle data throughput at the expense of silicon area.

A coarse rotation is performed to rotate the input sample from the full circle into the first quadrant. (The coarse rotation stage is required as the CORDIC algorithm is only valid over the first quadrant). An inverse coarse rotation stage rotates the output sample into the correct quadrant.

The CORDIC algorithm introduces a scale factor to the amplitude of the result, and the CORDIC core provides the option of automatically compensating for the CORDIC scale factor.

Changes from CORDIC 4.0 to CORDIC 6.0

AXI compliant

- The CORDIC 6.0 block is AXI compliant.

Ports Renamed

- **en** to **aclken**
- **rst** to **aresetn**
- **rdy** maps to **dout_tready**. **cartesian_tready** and **phase_tready** are automatically added when their respective channels are added.
- **x_in** to **cartesian_tdata_real**
- **y_in** to **cartesian_tdata_imag**
- **phase_in** to **phase_tdata_phase**
- **x_out** to **dout_tdata_real**
- **y_out** to **dout_tdata_imag**
- **phase_out** to **dout_tdata_phase**

Port Changes

- The data output ports are not optional in CORDIC 6.0. The data output ports are selected based on the Function selected.
- A fully parallel configuration with single-cycle data throughput at the expense. There are separate **tuser**, **tlast**, and **tready** ports for the Cartesian and Phase input channels.
- The **dout_tlast** output port can be configured to provide **tlast** from the Cartesian input channel, from the Phase input channel, or the AND and or the OR of all **tlasts**.

Optimization

- When you select **Blocking** mode for the AXI behavior, you can then select whether the core is configured for minimum **Resources** or maximum **Performance**.

Displaying Port Names on the Block Icon

- You can select **Display shortened port names** to trim the length of the AXI port names on the block icon.

Block Parameters

- **Page 1 tab:**
 - **Functional selection:**

- **Rotate:** When selected, the input vector, (real, imag), is rotated by the input angle using the CORDIC algorithm. This generates the scaled output vector, $Z_i * (real', imag')$.
- **Translate:** When selected, the input vector (real, imag) is rotated using the CORDIC algorithm until the imag component is zero. This generates the scaled output magnitude, $Z_i * Mag(real, imag)$, and the output phase, $Atan(imag/real)$.
- **Sin_and_Cos:** When selected, the unit vector is rotated, using the CORDIC algorithm, by input angle. This generates the output vector (Cos(), Sin()).
- **Sinh_and_Cosh:** When selected, the CORDIC algorithm is used to move the vector (1,0) through hyperbolic angle p along the hyperbolic curve. The hyperbolic angle represents the log of the area under the vector (real, imag) and is unrelated to a trigonometric angle. This generates the output vector (Cosh(p), Sinh(p)).
- **Arc_Tan:** When selected, the input vector (real, imag) is rotated (using the CORDIC algorithm) until the imag component is zero. This generates the output angle, $Atan(imag/real)$.
- **Arc_Tanh:** When selected, the CORDIC algorithm is used to move the input vector (real, imag) along the hyperbolic curve until the imag component reaches zero. This generates the hyperbolic “angle,” $Atanh(imag/real)$. The hyperbolic angle represents the log of the area under the vector (real, imag) and is unrelated to a trigonometric angle.
- **Square_Root:** When selected a simplified CORDIC algorithm is used to calculate the positive square root of the input.
- **Architectural configuration:** Configuration:
 - **Word_Serial:** Select for a hardware result with a small area.
 - **Parallel:** Select for a hardware result with high throughput.
- **Pipelining mode:**
 - **No_Pipelining:** The CORDIC core is implemented without pipelining.
 - **Optimal:** The CORDIC core is implemented with as many stages of pipelining as possible without using any additional LUTs.
 - **Maximum:** The CORDIC core is implemented with a pipeline after every shift-add sub stage.
- **Data format:**
 - **SignedFraction:** Default setting. The real and imag inputs and outputs are expressed as fixed-point 2’s complement numbers with an integer width of 2-bits.
 - **UnsignedFraction:** Available only for Square Root functional configuration. The real and imag inputs and outputs are expressed as unsigned fixed-point numbers with an integer width of 1-bit.

- **UnsignedInteger:** Available only for Square Root functional configuration. The real and imag inputs and outputs are expressed as unsigned integers.
- **Phase format:**
 - **Radians:** The phase is expressed as a fixed-point 2's complement number with an integer width of 3-bits, in radian units.
 - **Scaled_Radians:** The phase is expressed as fixed-point 2's complement number with an integer width of 3-bits, with pi-radian units. One scaled-radian equals $\text{Pi} * 1$ radians.
- **Input/Output Options:**
 - **Input width:** Controls the width of the input ports **cartesian_tdata_real**, **cartesian_tdata_imag**, and **phase_tdata_phase**. The Input width range 8 to 48 bits.
 - **Output width:** Controls the width of the output ports **dout_tdata_real**, **dout_tdata_imag**, and **dout_tdata_phase**. The Output width range 8 to 48 bits.
- **Round mode:**
 - **Truncate:** The real, imag, and phase outputs are truncated.
 - **Round_Pos_Inf:** The real, imag, and phase outputs are rounded (1/2 rounded up).
 - **Round_Pos_Neg_Inf:** The real, imag, and phase outputs are rounded (1/2 rounded up, -1/2 rounded down).
 - **Nearest_Even:** The real, imag, and phase outputs are rounded toward the nearest even number (1/2 rounded down and 3/2 is rounded up).
- **Page 2 tab:**
 - **Advanced Configuration Parameters:**
 - **Iterations:** Controls the number of internal add-sub iterations to perform. When set to zero, the number of iterations performed is determined automatically based on the required accuracy of the output.
 - **Precision:** Configures the internal precision of the add-sub iterations. When set to zero, internal precision is determined automatically based on the required accuracy of the output and the number of internal iterations.
 - **Compensation scaling:** Controls the compensation scaling module used to compensate for CORDIC magnitude scaling. CORDIC magnitude scaling affects the Vector Rotation and Vector Translation functional configurations, and does not affect the SinCos, SinhCosh, ArcTan, ArcTanh and Square Root functional configurations. For the latter configurations, compensation scaling is set to No Scale Compensation.
 - **Coarse rotation:**

Controls the instantiation of the coarse rotation module. Instantiation of the coarse rotation module is the default for the following functional configurations: Vector rotation, Vector translation, Sin and Cos, and Arc Tan. If Coarse Rotation is turned off for these functions then the input/output range is limited to the first quadrant ($-\pi/4$ to $+\pi/4$).

Coarse rotation is not required for the Sinh and Cosh, Arctanh, and Square Root configurations. The standard CORDIC algorithm operates over the first quadrant. Coarse Rotation extends the CORDIC operational range to the full circle by rotating the input sample into the first quadrant and inverse rotating the output sample back into the appropriate quadrant.

- **Optional ports:**
 - **Standard:**
 - **aclken:** When this signal is not asserted, the block holds its current state until the signal is asserted again or the aresetn signal is asserted. The aresetn signal has precedence over this clock enable signal. This signal has to run at a multiple of the blocks sample rate. The signal driving this port must be Boolean.
 - **aresetn:** When this signal is asserted, the block goes back to its initial state. This reset signal has precedence over the optional aclken signal available on the block. The reset signal has to run at a multiple of the block's sample rate. The signal driving this port must be Boolean.
 - **tready:** Adds **dout_tready** port if Blocking mode is activated.
 - **Cartesian:**
 - **tlast:** Adds a tlast input port to the Cartesian input channel.
 - **tuser:** Adds a tuser input port to the Cartesian input channel.
 - **tuser width:** Specifies the bit width of the Cartesian tuser input port.
 - **Phase:**
 - **tlast:** Adds a tlast input port to the Phase input channel.
 - **tuser:** Adds a tuser input port to the Phase input channel.
 - **tuser width:** Specifies the bit width of the Phase tuser input port.
 - **Tlast behavior:**
 - **Null:** Data output port.
 - **Pass_Cartesian_TLAST:** Data output port.
 - **Pass_Phase_TLAST:** Data output port.

- **OR_all_TLASTS:** Pass the logical OR of all the present TLAST input ports.
- **AND_all_TLASTS:** Pass the logical AND of all the present TLAST input ports
- **Flow control:**
 - **AXI behavior:**
 - **NonBlocking:** Selects “Non-Blocking” mode. In this mode, the lack of data on one input channel does not block the execution of an operation if data is received on another input channel.
 - **Blocking:** Selects “Blocking” mode. In this mode, the lack of data on one input channel does block the execution of an operation if data is received on another input channel.
 - **Optimization:** When NonBlocking mode is selected, the following optimization options are activated:
 - **Resources:** Core is configured for minimum resources.
 - **Performance:** Core is configured for maximum performance.
- **Implementation tab:**
 - **Block Icon Display:**
 - **Display shortened port names:** This option is ON by default. When unselected, the full AXI name of each port is displayed on the block icon.

LogiCORE Documentation

[LogiCORE IP CORDIC v6.0](#)

Counter

This block is listed in the following Xilinx Blockset libraries: Basic Elements, Control Logic, Math, and Index.

The Xilinx Counter block implements a free-running or count-limited type of an up, down, or up/down counter. The counter output can be specified as a signed or unsigned fixed-point number.

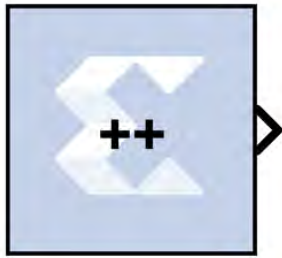

Free-running counters are the least expensive in FPGA hardware. The free-running up, down, or up/down counter can also be configured to load the output of the counter with a value on the input *din* port by selecting the **Provide Load Pin** option in the block's parameters.

$$out(n) = \begin{cases} InitialValue & \text{if } n=0 \\ (out(n-1)+Step) \bmod 2^N & \text{otherwise} \end{cases}$$

The output for a free-running up counter is calculated as follows:

$$out(n) = \begin{cases} InitialValue & \text{if } n=0 \\ din(n-1) & \text{if } load(n-1)=1 \\ (out(n-1)+Step) \bmod 2^N & \text{otherwise} \end{cases}$$

Here *N* denotes the number of bits in the counter. The free-running down counter calculations replace addition with subtraction.

For the free-running up/down counter, the counter performs addition when input up port is 1 or subtraction when the input up port is 0.

A count-limited counter is implemented by combining a free-running counter with a comparator. Count limited counters are limited to only 64 bits of output precision. Count limited types of a counter can be configured to step between the initial and ending values, provided the step value evenly divides the difference between the initial and ending values.

The output for a count limited up counter is calculated as follows:

$$out(n) = \begin{cases} InitialValue & \text{if } n=0 \text{ or } out(n-1)=CountLimit \\ (out(n-1)+Step) \bmod 2^N & \text{otherwise} \end{cases}$$

The count-limited down counter calculation replaces addition with subtraction. For the count limited up/down counter, the counter performs addition when input up port is 1 or subtraction when input up port is 0.

The output for a free-running up counter with load capability is calculated as follows:

$$out(n) = \begin{cases} StartCount & \text{if } n=0 \text{ or } rst(n)=1 \\ din & \text{if } rst(n) = 0 \text{ and } load(n) = 1 \\ (out(n-1)+CountBy Value) \bmod 2^N & \text{otherwise} \end{cases}$$

Here N denotes the number of bits in the counter. The down counter calculations replace addition by subtraction.

Block Parameters

The block parameters dialog box can be invoked by double-clicking the icon in your Simulink model.

- **Basic tab:**

Parameters specific to the Basic tab are as follows:

- **Counter type:** Specifies the counter to be a count-limited or free-running counter.
- **Count to value:** Specifies the ending value, the number at which the count-limited counter resets. A value of `Inf` denotes the largest representable output in the specified precision. This cannot be the same as the initial value.
- **Count direction:** Specifies the direction of the count (up or down) or provides an optional input port up (when up/down is selected) for specifying the direction of the counter.
- **Initial value:** Specifies the initial value to be the output of the counter.
- **Step:** Specifies the increment or decrement value.
- **Output type:** Specifies the block output to be either Signed or Unsigned.
- **Number of bits:** Specifies the number of bits in the block output.
- **Binary point:** Specifies the location of the binary point in the block output.
- **Provide load port:** When checked, the block operates as a free-running load counter with explicit load and din port. The load capability is available only for the free-running counter.
- **Provide Synchronous reset port:** Activates an optional reset (rst) pin on the block. When the reset signal is asserted the block goes back to its initial state. Reset signal has precedence over the optional enable signal available on the block. The reset signal has to run at a multiple of the block's sample rate. The signal driving the reset port must be Boolean..

- **Implementation tab:**

Parameters specific to the Implementation tab are as follows.

- **Implementation Details:**

- **Use behavioral HDL (otherwise use core):** The block is implemented using behavioral HDL. This gives the downstream logic synthesis tool maximum freedom to optimize for performance or area. Core Parameters
 - **Implement using:** Core logic can be implemented in **Fabric** or in a **DSP48**, if a DSP48 is available in the target device. The default is **Fabric**.

Other parameters used by this block are explained in the topic [Common Options in Block Parameter Dialog Boxes](#).

LogiCORE Documentation

[LogiCORE IP Binary Counter v12.0](#)

DDS Compiler 6.0

This block is listed in the following Xilinx® Blockset libraries: AXI4, DSP and Index.

The Xilinx DDS (Direct Digital Synthesizer) Compiler block implements high performance, optimized Phase Generation and Phase to Sinusoid circuits with AXI4-Stream compliant interfaces for supported devices.

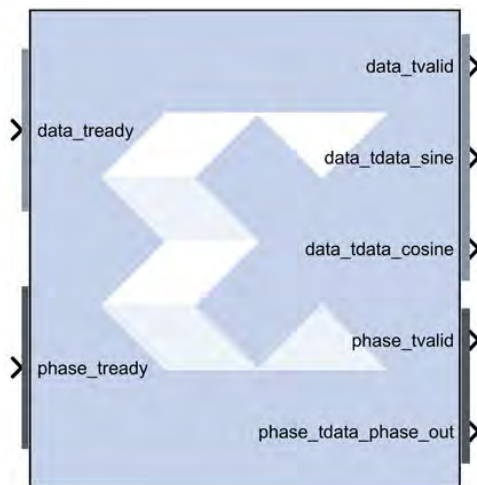

The core sources sinusoidal waveforms for use in many applications. A DDS consists of a Phase Generator and a SIN/COS Lookup Table (phase to sinusoid conversion). These parts are available individually or combined using this core.

Architecture Overview

To understand the DDS Compiler, it is necessary to know how the block is implemented in FPGA hardware. The following is a block diagram of the DDS Compiler core. The core consist of two main parts, a Phase Generator part and a SIN/COS LUT part. These parts can be used independently or together with an optional dither generator to create a DDS capability. A time-division multi-channel capability is supported with independently configurable phase increment and offset parameters.

Figure 12: DDS Compiler Block Diagram

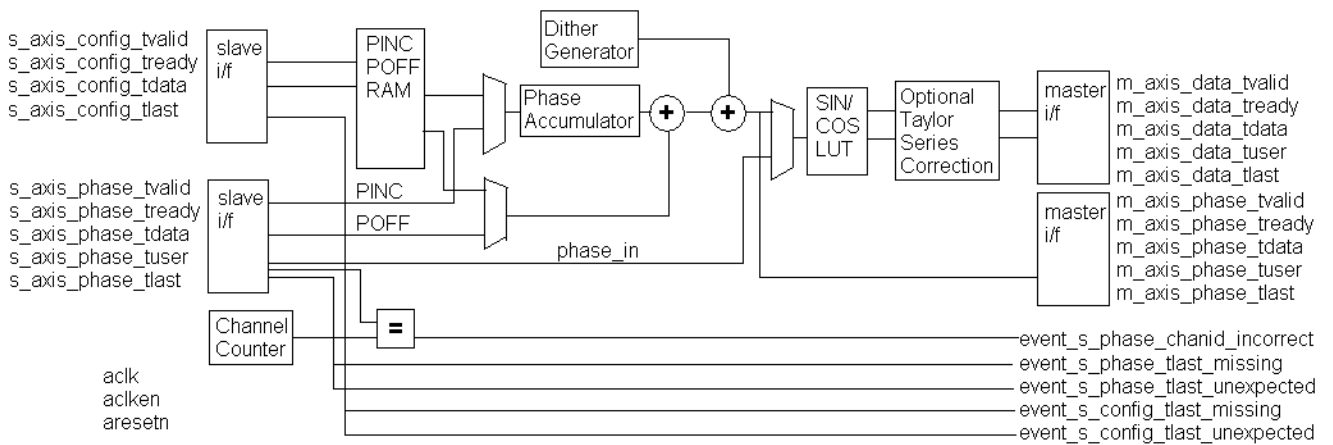

Phase Generator

The Phase Generator consists of an accumulator followed by an optional adder to provide addition of phase offset. When the core is customized the phase increment and offset can be independently configured to be either fixed, programmable (using the CONFIG channel) or dynamic (using the input PHASE channel).

When set to fixed the DDS output frequency is set when the core is customized and cannot be adjusted once the core is embedded in a design.

When set to programmable, the CONFIG channel TDATA field will have a subfield for the input in question (PINC or POFF) or both if both have been selected to be programmable. If neither PINC nor POFF is set to programmable, there is no CONFIG channel.

When set to streaming, the input PHASE channel TDATA port (s_axis_phase_tdata) will have a subfield for the input in question (PINC or POFF) or both if both have been selected to be streaming. If neither PINC nor POFF is set to streaming, and the DDS is configured to have a Phase Generator then there is no input PHASE channel. Note that when the DDS is configured to be a SIN/COS Lookup only, the PHASE_IN field is input using the input PHASE channel TDATA port.

SIN/COS LUT

When configured as a SIN/COS Lookup only, the Phase Generator is not implemented, and the PHASE_IN signal is input using the input PHASE channel, and transformed into the SINE and COSINE outputs using a look-up table.

Efficient memory usage is achieved by exploiting the symmetry of sinusoid waveforms. The core can be configured for SINE only output, COSINE only output or both (quadrature) output. Each output can be configured independently to be negated. Precision can be increased using optional Taylor Series Correction. This exploits XtremeDSP slices on FPGA families that support them to achieve high SFDR with high speed operation.

AXI Ports that are Unique to this Block

Depending on the Configuration Options and Phase Increment/Offset Programmability options selected, different subfield-ports for the PHASE channel or the CONFIG channel (or both channels) are available on the block, as described in the table below.

Configuration Option	Phase Increment Programmability		Phase Offset Programmability	
	Option Selected	Available Port	Option Selected	Available Port
Phase_Generator_only Phase_Generator_and_ SIN_COS_LUT	Programmable	s_axis_config_tdata_pin_c	Programmable	s_axis_config_tdata_poff
	Streaming	s_axis_phase_tdata_pin_c	Streaming	s_axis_phase_tdata_poff
	Fixed	NA	Fixed	NA
			None	NA
SIN_COS_LUT_only	In this configuration, input port s_axis_phase_tdata_phase_in are available			

Block Parameters

The block parameters dialog box can be invoked by double-clicking the icon in your Simulink® model.

- **Basic tab:**

Parameters specific to the Basic tab are as follows.

- **Configuration Options:** This parameter allows for two parts of the DDS to be instantiated separately or instantiated together. Select one of the following.
 - Phase_Generator_and_SIN_COS_LUT
 - Phase_Generator_only
 - SIN_COS_LUT_only
- **System Requirements:**
 - **System Clock (MHz):** Specifies the frequency at which the block is clocked for the purposes of making architectural decisions and calculating phase increment from the specified output frequency. This is a fixed ratio off the System Clock.
 - **Number of Channels:** The channels are time-multiplexed in the DDS which affects the effective clock per channel. The DDS can support 1 to 16 time-multiplexed channels.

- **Mode of Operation:**

- **Standard:** The output frequency of the DDS waveform is a function of the system clock frequency, the phase width in the phase accumulator and the phase increment value.
- **Rasterized:** The DDS does not truncate the accumulated phase. Rasterized operation is intended for configurations where the desired frequency is a rational fraction of the system clock (output frequency = system frequency * N/M, where 0 < N < M). Values of M from 9 to 16384 are supported.

Note: Refer to the document [LogiCORE IP DDS Compiler v6.0 Product Guide](#) for a detailed explanation of these modes.

- **Parameter Selection:** Select **System_Parameters** or **Hardware_Parameters**

- **System Parameters:**

- **Spurious Free Dynamic Range (dB):** The targeted purity of the tone produced by the DDS. This sets the output width as well as internal bus widths and various implementation decisions.
- **Frequency Resolution (Hz):** This sets the precision of the PINC and POFF values. Very precise values will require larger accumulators. Less precise values will cost less in hardware resource.
- **Noise Shaping:** Select one: **None**, **Phase_Dithering**, **Taylor_Series_Corrected**, or **Auto**.

If the Configuration Options selection is **SIN_COS_LUT_only**, then **None** and **Taylor_Series_Corrected** are the only valid options for Noise Shaping. If **Phase_Generator_Only** is selected, then **None** is the only valid choice for Noise Shaping.

- **Hardware Parameters:**

- **Phase Width:** Equivalent to frequency resolution, this sets the width of the internal phase calculations.
- **Output Width:** Broadly equivalent to SFDR, this sets the output precision and the minimum Phase Width allowable. However, the output accuracy is also affected by the choice of Noise Shaping.

- **Output Selection:**

- **Sine_and_Cosine:** Place both a Sine and Cosine output port on the block.
- **Sine:** Place only a Sine output port on the block.
- **Cosine:** Place only a Cosine output port on the block.
- **Polarity:**
 - **Negative Sine:** Negates the sine output.

- **Negative Cosine:** Negates the **cosine** output.
- **Amplitude Mode:**
 - **Full_Range:** Selects the maximum possible amplitude.
 - **Unit_Circle:** Selects an exact power-of-two amplitude, which is about one half the Full_Range amplitude.
- **Implementation tab:**
 - **Implementation Options:**
 - **Memory Type:** Select between **Auto**, **Distributed_ROM**, or **Block_ROM**.
 - **Optimization Goal:** Select between **Auto**, **Area**, or **Speed**.
 - **DSP48 Use:** Select between **Minimal**, or **Maximal**. When set to Maximal, XtremeDSP slices are used to achieve to maximum performance.
 - **Latency Options:**
 - **Auto:** The DDS is fully pipelined for optimal performance.
 - **Configurable:** Allows you to select less pipeline stages in the **Latency** pulldown menu below. This generally results in less resources consumed.
 - **Control Signals:**
 - **Has phase out:** When checked the DDS will have the `phase_output` port. This is an output of the Phase_Generator half of the DDS, so it precedes the sine and cosine outputs by the latency of the sine/cosine lookup table.
 - **ACLKEN:** Enables the clock enable (`aclken`) pin on the core. All registers in the core are enabled by this control signal.
 - **ARESETn:** Active-low synchronous clear input that always takes priority over ACLKEN. A minimum ARESETn active pulse of two cycles is required, since the signal is internally registered for performance. A pulse of one cycle resets the core, but the response to the pulse is not in the cycle immediately following.
 - **Explicit Sample Period:**
 - **Use explicit period:** When checked, the DDS Compiler block uses the explicit sample period that is specified in the dialog entry box below.
- **AXI Channel Options tab:**
 - **AXI Channel Options:**
 - **TLAST:**

Enabled when there is more than one DDS channel (as opposed to AXI channel), as TLAST is used to denote the transfer of the last time-division multiplied channel of the DDS. Options are as follows.

- **Not_Required:** In this mode, no TLAST appears on the input PHASE channel nor on the output channels.
- **Vector_Framing:** In this mode, TLAST on the input PHASE channel and output channels denotes the last.
- **Packet_Framing:** In this mode, TLAST is conveyed from the input PHASE channel to the output channels with the same latency as TDATA. The DDS does not use or interpret the TLAST signal in this mode. This mode is intended as a service to ease system design for cases where signals must accompany the datastream, but which have no application in the DDS.
- **Config_Triggered:** This is an enhanced variant of the Vector Framing option. In this option, the TLAST on the input PHASE channel can trigger the adoption of new configuration data from the CONFIG channel when there is new configuration data available. This allows the re-configuration to be synchronized with the cycle of time-division-multiplexed DDS channels.
- **TREADY:**
 - **Output TREADY:** When selected, the output channels will have a TREADY and hence support the full AXI handshake protocol with inherent back-pressure. If there is an input PHASE channel, its TREADY is also determined by this control, so that the datapath from input PHASE channel to output channels as a whole supports backpressure or not.
- **TUSER Options:** Select one of the following options for the **Input**, **DATA Output**, and **PHASE Output**.
 - **Not_Required:** Neither of the above uses is required; the channel in question will not have a TUSER field.
 - **Chan_ID_Field:** In this mode, the TUSER field identifies the time-division-multiplexed channel for the transfer.
 - **User_Field:** In this mode, the block ignores the content of the TUSER field, but passes the content untouched from the input PHASE channel to the output channels.
 - **User and Chan_ID_Field:** In this mode, the TUSER field has both a `user` field and a `chan_id` field, with the `chan_id` field in the least significant bits. The minimal number of bits required to describe the channel will determine the width of the `chan_id` field. For example, 7 channels will require 3 bits.
 - **User Field Width:** This field determines the width of the bit field which is conveyed from input to output untouched by the DDS.
- **Config Channel Options:**

- **Synchronization Mode:**
 - **On_Vector:** In this mode, the re-configuration data is applied when the channel starts a new cycle of time-division-multiplexed channels.
 - **On_Packet:** In this mode, available when TLAST is set to packet framing, the TLAST channel will trigger the re-configuration. This mode is targeted at the case where it is to be associated with the packets implied by the input TLAST indicator.
- **Output Frequency tab:**
 - **Phase Increment Programmability:**

Specifies the phase increment to be **Fixed**, **Programmable** or **Streaming**. The choice of Programmable adds channel, data, and we input ports to the block.

The following fields are activated when Phase_Generator_and_SIN_COS_LUT is selected as the Configuration Options field on the Basic tab, the Parameter Selection on the Basic tab is set to Hardware Parameters and Phase Increment Programmability field on the Phase Offset Angles tab is set to **Fixed** or **Programmable**.

 - **Output frequencies (MHz):** For each channel, an independent frequency can be entered into an array. This field is activated when Parameter Selection on the Basic tab is set to **System Parameters** and Phase Increment Programmability is **Fixed** or **Programmable**.
 - **Phase Angle Increment Values:** This field is activated when Phase_Generator_and_SIN_COS_LUT is selected as the Configuration Options field on the Basic tab, the Parameter Selection on the Basic tab is set to **Hardware Parameters** and Phase Increment Programmability field on the Phase Offset Angles tab is set to **Fixed** or **Programmable**. Values must be entered in binary. The range is 0 to the weight of the accumulator, for example, $2^{\text{Phase_Width}}-1$.
- **Phase Offset Angles tab:**
 - **Phase Offset Programmability:** Specifies the phase offset to be **None**, **Fixed**, **Programmable** or **Streaming**. The choice of Fixed or Programmable adds the channel, data, and we input ports to the block.
 - **Phase Offset Angles (x2pi radians):** For each channel, an independent offset can be entered into an array. The entered values are multiplied by 2π radians. This field is activated when Parameter Selection on the Basic tab is set to System Parameters and Phase Increment Programmability is **Fixed** or Programmable.
 - **Phase Angle Offset Values:** For each channel, an independent offset can be entered into an array. The entered values are multiplied by 2π radians. This field is activated when Parameter Selection on the Basic tab is set to Hardware Parameters and Phase Increment Programmability is Fixed or Programmable.
- **Advanced tab:** Block Icon Display

- **Display shortened port names:** This option is ON by default. When unselected, the full AXI name of each port is displayed on the block.

Other parameters used by this block are explained in the topic [Common Options in Block Parameter Dialog Boxes](#).

LogiCORE Documentation

[LogiCORE IP DDS Compiler v6.0 Product Guide](#)

Delay

This block is listed in the following Xilinx® Blockset libraries: Basic Elements, Floating-Point, Memory, and Index.

The Xilinx Delay block implements a fixed delay of L cycles.

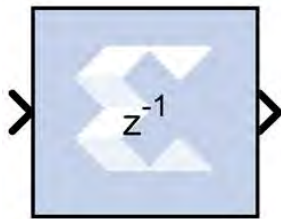

The delay value is displayed on the block in the form z^{-L} , which is the *Z-transform* of the block's transfer function. Any data provided to the input of the block will appear at the output after L cycles. The rate and type of the data of the output is inherited from the input. This block is used mainly for matching pipeline delays in other portions of the circuit. The delay block differs from the register block in that the register allows a latency of only 1 cycle and contains an initial value parameter. The delay block supports a specified latency but no initial value other than zeros. The figure below shows the Delay block behavior when **L=4** and **Period=1s**.

Figure 13: Delay Block Behavior

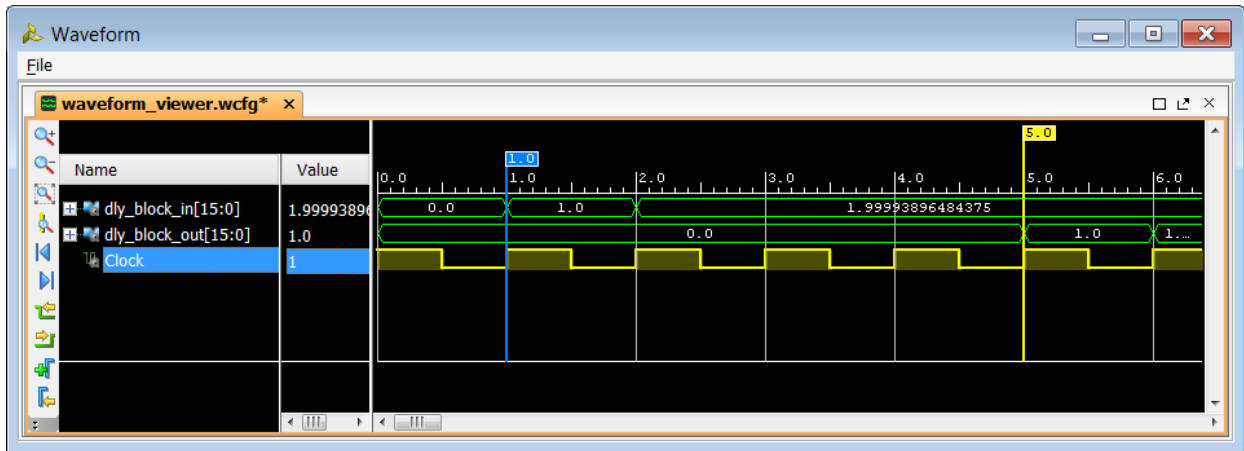

For delays that need to be adjusted during run-time, you should use the **Addressable Shift Register** block. Delays that are not an integer number of clock cycles are not supported and such delays should not be used in synchronous design (with a few rare exceptions).

Block Parameters

The block parameters dialog box can be invoked by double-clicking the icon in your Simulink® model.

- **Basic tab:**

Parameters specific to the Basic tab are as follows:

- **Provide synchronous reset port:** this option activates an optional reset (rst) pin on the block. When the reset signal is asserted the block goes back to its initial state. Reset signal has precedence over the optional enable signal available on the block. The reset signal has to run at a multiple of the block's sample rate. The signal driving the reset port must be Boolean.
- **Provide enable port::** this option activates an optional enable (en) pin on the block. When the enable signal is not asserted the block holds its current state until the enable signal is asserted again or the reset signal is asserted. Reset signal has precedence over the enable signal. The enable signal has to run at a multiple of the block 's sample rate. The signal driving the enable port must be Boolean.
- **Latency:** Latency is the number of cycles of delay. The latency can be zero, provided that the **Provide enable port** checkbox is not checked. The latency must be a non-negative integer. If the latency is zero, the delay block collapses to a wire during logic synthesis. If the latency is set to $L=1$, the block will generally be synthesized as a flip-flop (or multiple flip-flops if the data width is greater than 1).
- **Implementation tab:**

Parameters specific to the Implementation tab are as follows:

- **Implement using behavioral HDL:** Uses behavioral HDL as the implementation. This allows the downstream logic synthesis tool to choose the best implementation.

Other parameters used by this block are explained in the topic [Common Options in Block Parameter Dialog Boxes](#).

Logic Synthesis using Behavioral HDL

This setting is recommended if you are using Synplify Pro as the downstream logic synthesis tool. The logic synthesis tool will implement the delay as it desires, performing optimizations such as moving parts of the delay line back or forward into blockRAMs, DSP48s, or embedded IOB flip-flops; employing the dedicated SRL cascade outputs for long delay lines based on the architecture selected; and using flip-flops to terminate either or both ends of the delay line based on path delays. Using this setting also allows the logic synthesis tool, if sophisticated enough, to perform retiming by moving portions of the delay line back into combinational logic clouds.

Logic Synthesis using Structural HDL

If you do not check the box **Implement using behavioral HDL**, then structural HDL is used. This is the default setting and results in a known, but less-flexible, implementation which is often better for use with Vivado synthesis. In general, this setting produces structural HDL comprising an SRL (Shift-Register LUT) delay of $(L-1)$ cycles followed by a flip-flop, with the SRL and the flip-flop getting packed into the same slice. For a latency greater than $L=33$, multiple SRL/flip-flop sets are cascaded, albeit without using the dedicated cascade routes. For example, the following is the synthesis result for a 1-bit wide delay block with a latency of $L=64$:

Figure 14: 1-Bit Wide Delay Block with a Latency of L=64

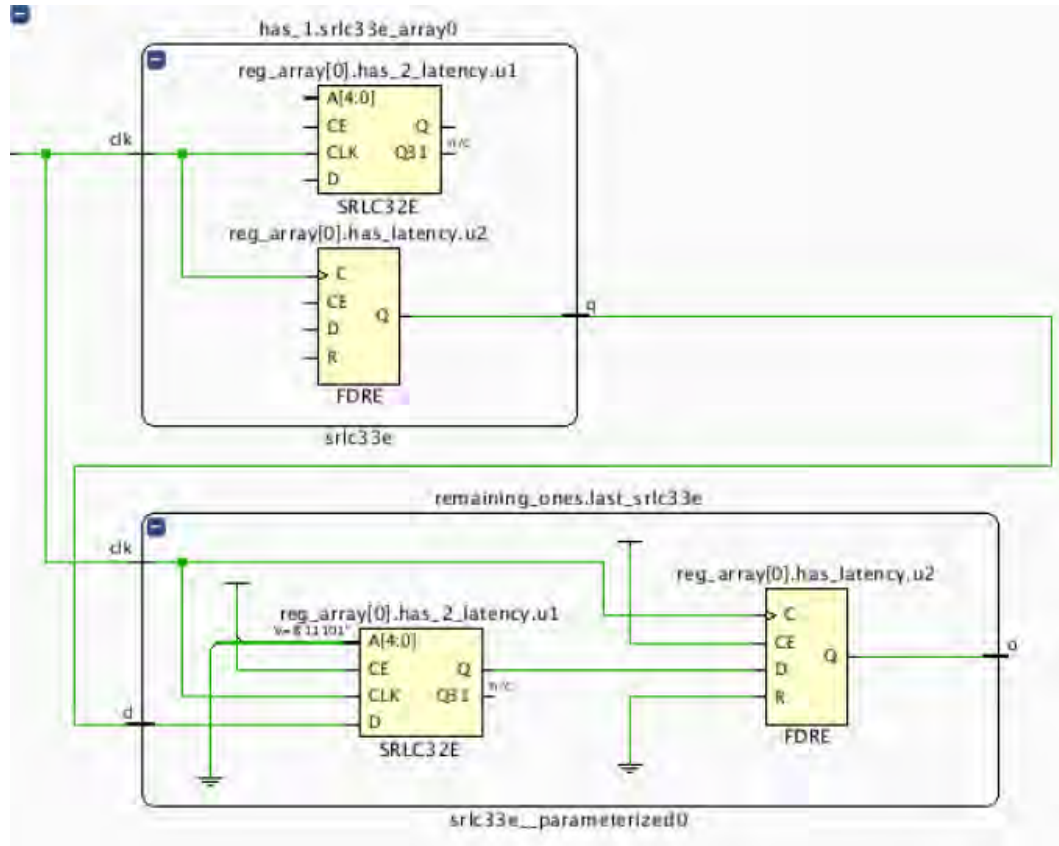

The first SRL provides a delay of 32 cycles and the associated flip-flop adds another cycle of delay. The second SRL provides a delay of 30 cycles; this is evident because the address is set to $\{A4,A3,A2,A1,A0\}=11101$ (binary) = 29, and the latency through an SRL is the value of the address plus one. The last flip-flop adds a cycle of delay, making the grand total $L=32+1+30+1=64$ cycles.

The SRL is an efficient way of implementing delays in the Xilinx architecture. An SRL and its associated flip-flop that comprise a single *logic cell* can implement 33 cycles of delay whereas a delay line consisting only of flip-flops can implement only one cycle of delay per logic cell.

The SRL has a setup time that is longer than that of a flip-flop. Therefore, for very fast designs with a combinational path preceding the delay block, it can be advantageous, when using the structural HDL setting, to precede the delay block with an additional delay block with a latency of $L=1$. This ensures that the critical path is not burdened with the long setup time of the SRL. An example is shown below.

Figure 15: Delay Block with an Additional Delay Block with a Latency

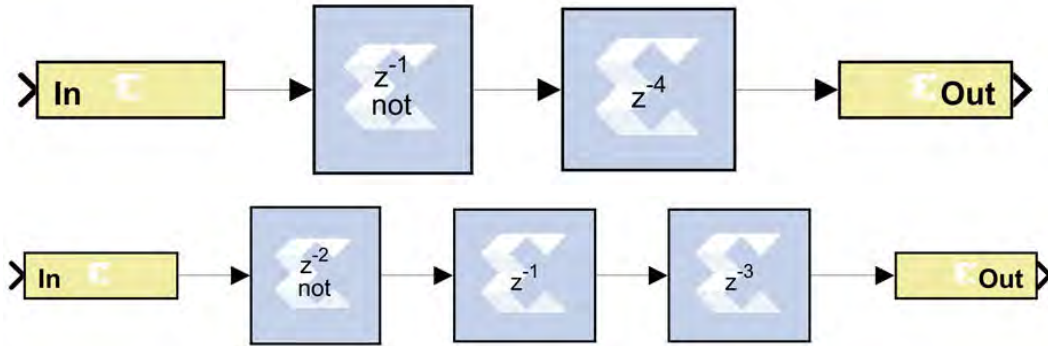

In the example, the two designs are logically equivalent, but the bottom one will have a faster hardware implementation. The bottom design will have the combinational path formed by Inverter1 terminated by a flip-flop, which has a shorter setup time than an SRL.

The synthesis results of both designs are shown below, with the faster design highlighted in red:

Figure 16: Synthesis Results

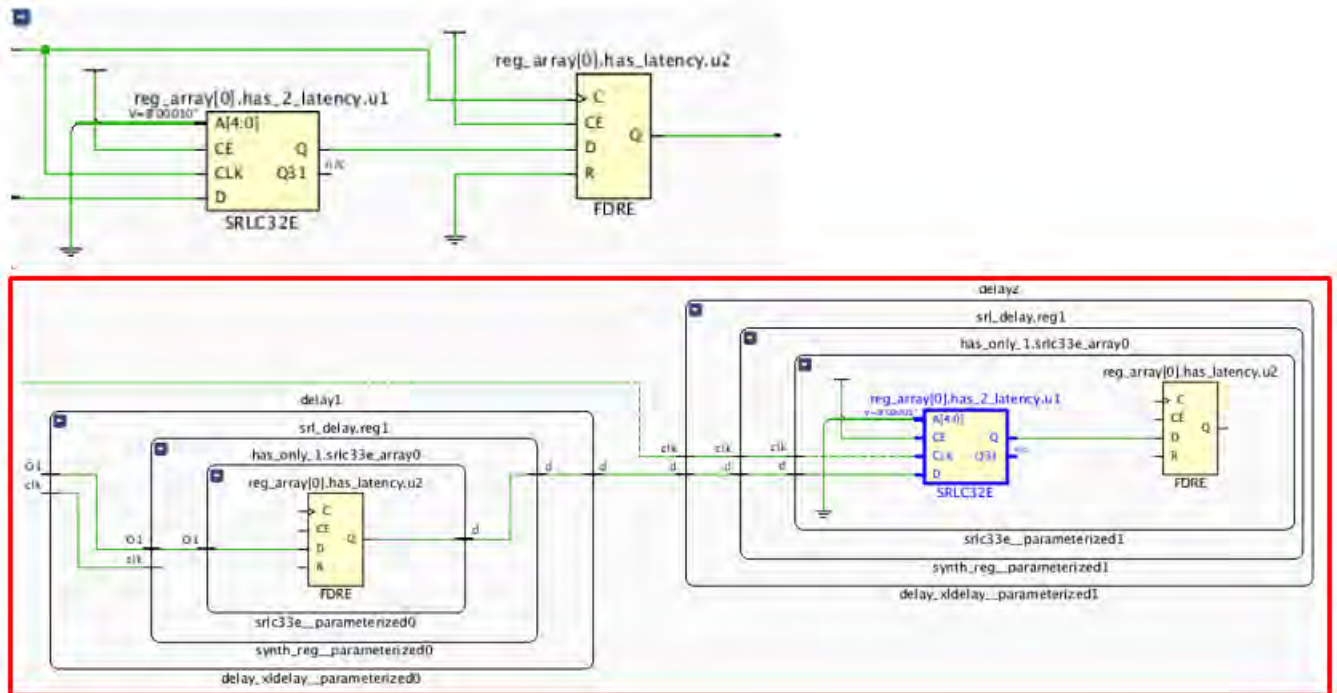

Note that an equivalent to the faster design results from setting the latency of *Inverter1* to 1 and eliminating *Delay1*. This, however, is not equivalent to setting the latency of *Inverter1* to 4 and eliminating the delay blocks; this would yield a synthesis equivalent to the upper (slower) design.

Implementing Long Delays

For very long delays, of, say, greater than 128 cycles, especially when coupled with larger bus widths, it might be better to use a block-RAM-based delay block. The delay block is implemented using SRLs, which are part of the general fabric in the Xilinx. Very long delays should be implemented in the embedded block RAMs to save fabric. Such a delay exploits the dual-port nature of the blockRAM and can be implemented with a fixed or run-time-variable delay. Such a block is basically a block RAM with some associated address counters. The model below shows a novel way of implementing a long delay using LFSRs (linear feedback shift registers) for the address counters in order to make the design faster, but conventional counters can be used as well. The difference in value between the counters (minus the RAM latency) is the latency L of the delay line.

Figure 17: Novel Use of Long Delay LFSRs

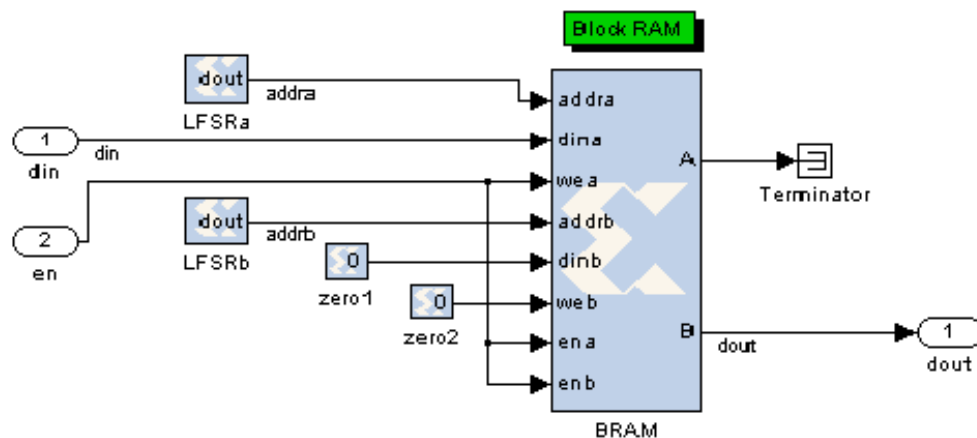

This delay element uses a blockRAM to implement large delays. The addressing is done with LFSRs, which are counters across a Galois field. The B port address is generated with a counter that starts at $\alpha^0 (=1)$, where α is the primitive element of the Galois field. The A port address is generated with a counter that starts at $\alpha^{(L-R)}$, where L is the desired total latency and R is the latency of the RAM.

Re-settable Delays and Initial Values

If a delay line absolutely must be re-settable to zero, this can be done by using a string of L register blocks to implement the delay or by creating a circuit that forces the output to be zero while the delay line is “flushed”.

The delay block does not support initial values, but the Addressable Shift Register block does. This block, when used with a fixed address, is generally equivalent to the delay block and will synthesize to an SRL-based delay line. The initial values pertain to initialization only and not to a reset. If using the addressable shift register in “structural HDL mode” (e.g., the **Use behavioral HDL** checkbox is not selected) then the delay line will not be terminated with a flip-flop, making it significantly slower. This can be remedied by using behavioral mode or by putting a Register or Delay block after the addressable shift register.

Depuncture

This block is listed in the following Xilinx® Blockset libraries: Communication and Index.

The Xilinx Depuncture block allows you to insert an arbitrary symbol into your input data at the location specified by the depuncture code.

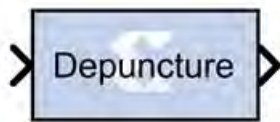

The Xilinx depuncture block accepts data of type U_{FixN_0} where N equals the length of insert string x (the number of ones in the depuncture code) and produces output data of type U_{FixK_0} where K equals the length of insert string multiplied by the length of the depuncture code.

The Xilinx Depuncture block can be used to decode a range of punctured convolution codes. The following diagram illustrates an application of this block to implement soft decision Viterbi decoding of punctured convolution codes.

Figure 18: Soft Decision Viterbi Decoding

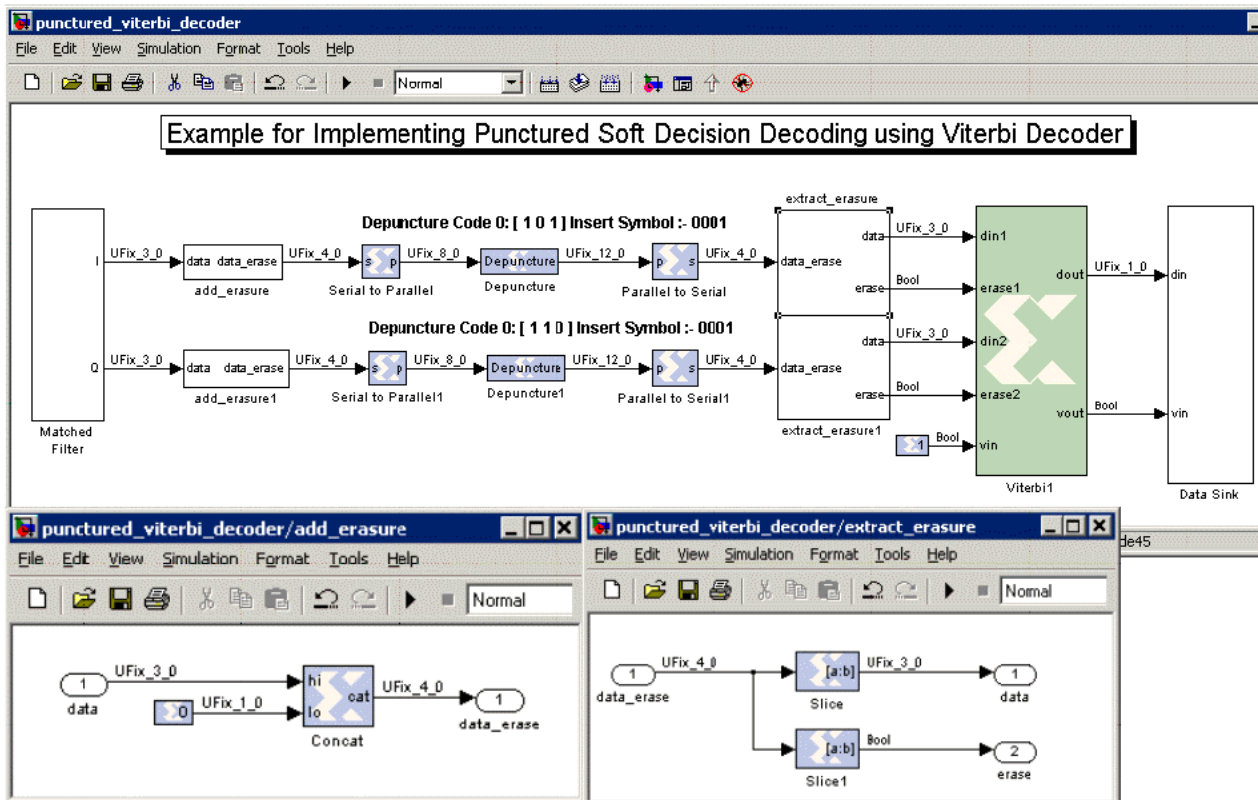

The previous diagram shows a matched filter block connected to a `add_erasure` Subsystem which attaches a 0 to the input data to mark it as a non-erasure signal. The output from the `add_erasure` subsystem is then passed to a serial to parallel block. The serial to parallel block concatenates two continuous soft inputs and presents it as a 8-bit word to the depuncture block. The depuncture block inserts the symbol '0001' after the 4-bits from the MSB for code 0 ($[1\ 0\ 1]$) and 8-bits from the MSB for code 1 ($[1\ 1\ 0]$) to form a 12-bit word. The output of the depuncture block is serialized as 4-bit words using the parallel to serial block. The `extract_erasure` Subsystem takes the input 4-bit word and extracts 3-bits from the MSB to form a soft decision input data word and 1-bit from the LSB to form the erasure signal for the Viterbi decoder.

Block Parameters

The block parameters dialog box can be invoked by double-clicking the icon in your Simulink® model.

Figure 19: Block Parameters

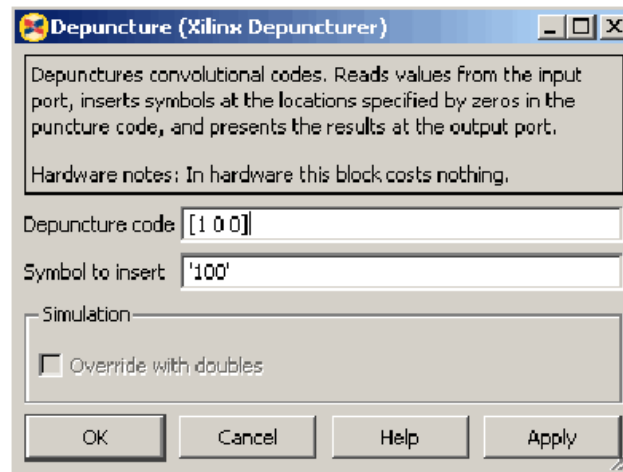

Parameters specific to the Xilinx Depuncturer block are:

- **Depuncture code:** Specifies the depuncture pattern for inserting the string to the input.
- **Symbol to insert:** Specifies the binary word to be inserted in the depuncture code.

Other parameters used by this block are explained in the topic [Common Options in Block Parameter Dialog Boxes](#).

Digital FIR Filter

This block is listed in the following Xilinx® Blockset libraries: DSP and Index.

The Xilinx Digital FIR Filter block allows you to generate highly parameterizable, area-efficient, high-performance single channel FIR filters.

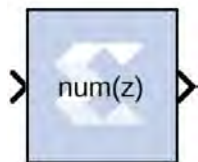

The Digital FIR filter block supports single channel, simple rate, integer decimation, and interpolation and fractional decimation and interpolation filter types.

To specify the coefficient vector for the FIR Filter generated by this block, you can either enter the coefficient vector directly into the Digital FIR Filter block parameters dialog box, or open an interface to the [FDATool](#) block and specify the coefficient vector in that interface.

The Digital FIR Filter block is ideal for generating simple, single channel FIR filters. If your FIR filter implementation will use more complicated filter features such as multiple channels or multiple path core configuration, an AXI4-Stream-compliant interface, or functions such as reloading co-efficient, channel pattern support, or other HDL-based GUI parameters, use the Xilinx [FIR Compiler 7.2](#) block in your design instead of the Digital FIR Filter block.

In the Vivado® design flow, the Digital FIR filter block is inferred as "LogiCORE™ IP FIR Compiler v7.2" for code generation. Refer to the document [LogiCORE IP FIR Compiler v7.2](#) for details on this LogicCore IP.

Block Parameters

The block parameters dialog box can be invoked by double-clicking the icon in your Simulink® model.

Parameters specific to the Xilinx Digital FIR Filter block areas follows.

- **Coefficient Vector:**

- **Use FDA Tool as Coefficient Source:** : If selected, the Coefficient Vector will be determined by the settings in the Filter Design and Analysis Tool (FDA Tool). To use the FDA Tool as your coefficient source, you must click the **FDATool** button and configure the Block Parameters dialog box that appears, to describe your FIR filter.

Note: Because the FDA Tool functionality is integrated into the Digital FIR Filter block itself, you do not have to enter a separate FDATool block into your design to use the FDA Tool as your coefficient source.

The FDA Tool is a user interface for designing and analyzing filters quickly. FDATool enables you to design digital FIR filters by setting filter specifications, by importing filters from your MATLAB® workspace, or by adding, moving or deleting poles and zeroes. FDA Tool also provides tools for analyzing filters, such as magnitude and phase response and pole-zero plots (see [FDATool](#)).

- **Edit Box:**

The edit box is enabled for you to specify the Coefficient Vector when the **Use FDA Tool as Coefficient Source** option is disabled. The edit box specifies the vector coefficients of the filter's transfer function. Filter coefficients must be specified as a single MATLAB row vector. Filter structure must be Direct Form, and the input must be a scalar.

The number of taps is inferred from the length of the MATLAB row vector. If multiple coefficient sets are specified, then each set is appended to the previous set in the vector.

- **FDATool:** This button is enabled if the **Use FDA Tool as Coefficient Source** option is enabled. Click this button to open a Block Parameters dialog box for the FDA Tool, and enter your filter specifications in this dialog box. To understand how to use this dialog box to describe your FIR filter, see [FDATool](#).

- **Coefficient Precision:**
 - **Optimal Values:** If selected, the Coefficient Width and Coefficient Fractional Bits will be set automatically to their optimum values. The values are calculated using the dynamic range of filter response between pass band and stop band signals. These values ensure the minimum hardware will be used for the required filter response when the design is implemented in the Xilinx FPGA or SoC.
 - **Coefficient Width:** Specifies the number of bits used to represent the coefficients.
 - **Coefficient Fractional Bits:** Specifies the binary point location in the coefficients datapath options.
 - **Interpolation Rate:** Specifies the interpolation rate of the filter. Any value greater than 1 is applicable to all Interpolation filter types and Decimation filter types for Fractional Rate Change implementations. The value provided in this field defines the upsampling factor, or P for Fixed Fractional Rate (P/Q) resampling filter implementations.
 - **Decimation Rate:** Specifies the decimation rate of the filter. Any value greater than 1 is applicable to the all Decimation and Interpolation filter types for Fractional Rate Change implementations. The value provided in this field defines the downsampling factor, or Q for Fixed Fractional Rate (P/Q) resampling filter implementations.

Example

A simple filter design is shown below which uses the Digital FIR Filter block to implement a single rate low pass filter. Because **Use FDA Tool as Coefficient source** is enabled in the block parameters dialog box for the Digital FIR Filter block, the FDA Tool (invoked by clicking the **FDA Tool** button) is used to generate the filter coefficient for the following specification:

- F_s (sample frequency) = 400 MHz
- F_{pass} = 11 MHz
- F_{stop} = 13 MHz
- A_{pass} = 1 dB
- A_{stop} = 120 dB

For **Coefficient precision**, the **Optimal values** selection is enabled for the filter **Coefficient Width** parameter. Therefore, an optimized filter coefficient width will be computed automatically, for minimum hardware usage and better filter response.

Figure 20: Digital FIR Filter Example

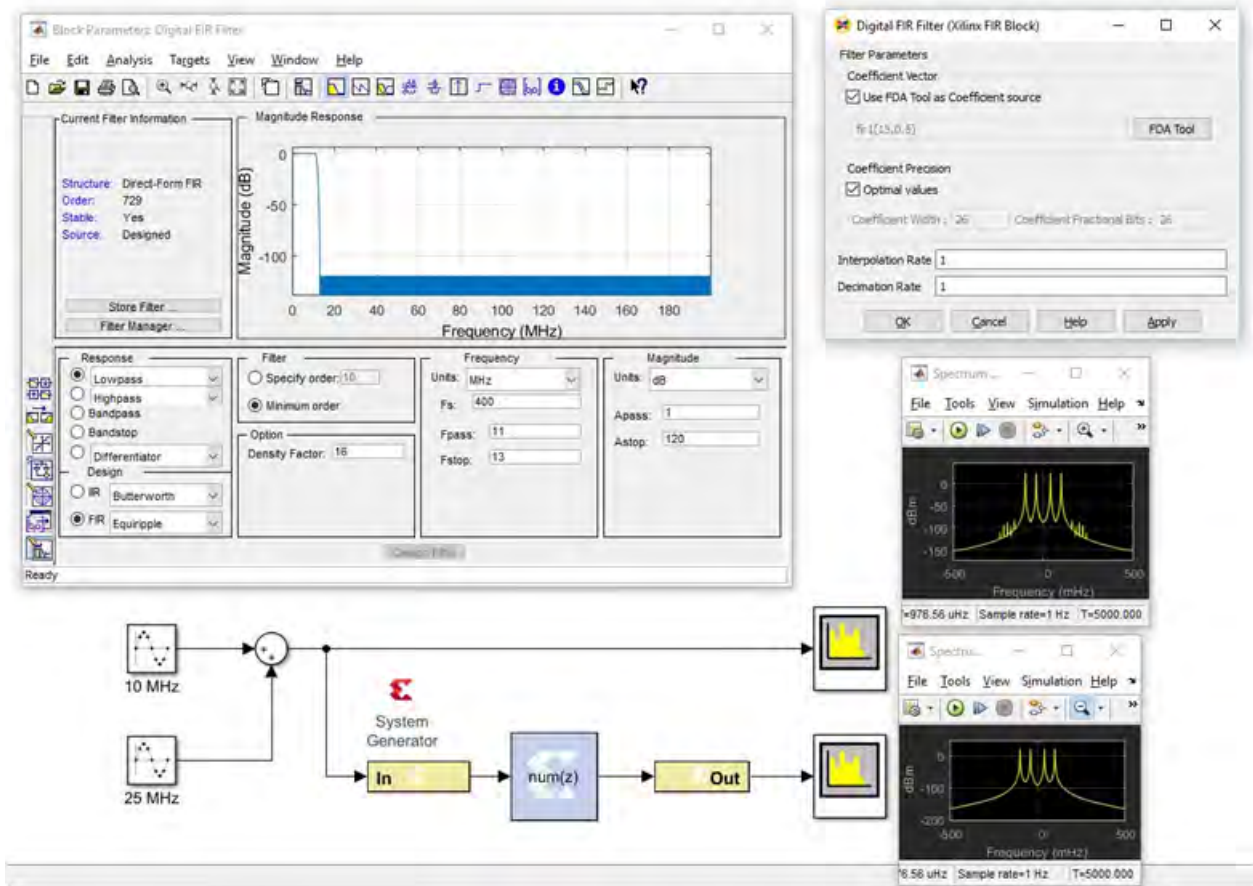

LogiCORE Documentation

[LogiCORE IP FIR Compiler v7.2](#)

Divide

This block is listed in the following Xilinx® Blockset libraries: Floating-Point, Math and Index.

The Xilinx Divide block performs both fixed-point and floating-point division with the **a** input being the dividend and the **b** input the divisor. Both inputs must be of the same data type.

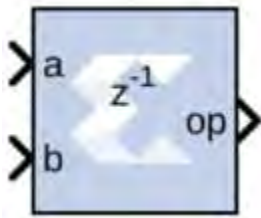

Block Parameters

- **Basic tab:** Parameters specific to the Basic tab are as follows
 - **AXI Interface:**
 - **Flow Control:**
 - **Blocking:** Selects “Blocking” mode. In this mode, the lack of data on one input channel does block the execution of an operation if data is received on another input channel.
 - **NonBlocking:** Selects “Non-Blocking” mode. In this mode, the lack of data on one input channel does not block the execution of an operation if data is received on another input channel.
 - **Fixed-point Options:**
 - **Algorithm Type:**
 - **Radix2:** This is non-restoring integer division using integer operands and allows a remainder to be generated. This option is recommended for operand widths less than 16 bits. This option supports both unsigned (two's complement) and signed divisor and dividend inputs.
 - **High_Radix:** This option is recommended for operand widths greater than 16 bits, though the implementation requires the use of DSP48 (or variant) primitives. This option only supports signed (two's complement) divisor and dividend inputs.
 - **LutMult:** A simple lookup estimate of the reciprocal of the divisor followed by a multiplier. Only remainder output type is supported because of the bias required in the reciprocal estimate. This bias would introduce an offset (error) if used to create a fractional output. This is recommended for operand widths less than or equal to 12 bits. This implementation uses DSP slices, block RAM, and a small number of FPGA logic primitives (registers and LUTs). For operand widths where either Radix2 or the LUTMult options are possible, the LUTMult solution offers a solution using fewer FPGA logic resources because of the use of DSP and block RAM primitives. Supports unsigned or two's complement signed numbers.
 - **Output Fractional width:** For Fixed-point division, this entry determines the number of bits in the fractional part of the output.

- **Optional Ports:**
 - **Dividend Channel Ports:**
 - **Has TLAST:** Adds a TLAST port to the Input channel.
 - **Has TUSER:** Adds a TUSER port to the Input channel.
 - **Divisor Channel Ports:**
 - **Has TLAST:** Adds a TLAST port to the Input channel.
 - **Has TUSER:** Adds a TUSER port to the Input channel.
- **Control Options:**
 - **Provide enable port:** Adds an enable port to the block interface.
 - **Has Result TREADY:** Adds a TREADY port to the Result channel.
 - **Output TLAST behavior:** Determines the behavior of the result_tlast output port.
 - **Pass_A_TLAST:** Pass the value of the a_tlast input port to the dout_tlast output port.
 - **Pass B_TLAST:** Pass the value of the b_tlast input port to the dout_tlast output port.
 - **OR_all_TLASTS:** Pass the logical OR of all the present TLAST input ports.
 - **AND_all_TLASTS:** Pass the logical AND of all the present TLAST input ports.
- **Exception Signals:**
 - **UNDERFLOW:** Adds an output port that serves as an underflow flag.
 - **OVERFLOW:** Adds an output port that serves as an overflow flag.
 - **INVALID_OP:** Adds an output port that serves as an invalid operation flag.
 - **DIVIDE_BY_ZERO:** Adds an output port that serves as a divide-by-zero flag.

Other parameters used by this block are explained in the topic [Common Options in Block Parameter Dialog Boxes](#).

LogiCORE Documentation

[LogiCORE IP Floating-Point Operator v7.1](#)

Divider Generator 5.1

This block is listed in the following Xilinx® Blockset libraries: AXI4, DSP, Math, and Index.

The Xilinx Divider Generator block creates a circuit for integer division based on Radix-2 non-restoring division, or High-Radix division with prescaling.

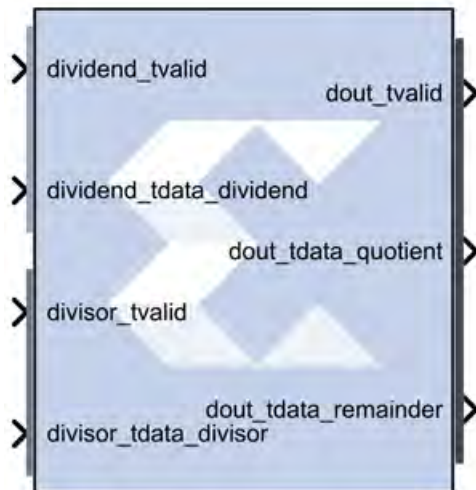

Block Parameters

The Block Parameters dialog box can be invoked by double-clicking the icon in your Simulink® model.

- **Basic tab:**
 - **Common Options:**
 - **Algorithm Type:**
 - **Radix-2** non-restoring integer division using integer operands, allows a remainder to be generated. This is recommended for operand widths less than around 16 bits. This option supports both **unsigned** and **signed** (2's complement) divisor and dividend inputs.
 - **High_Radix** division with prescaling. This is recommended for operand widths greater than 16 bits, though the implementation requires the use of DSP48 (or variant) primitives. This option only supports **signed** (2's complement) divisor and dividend inputs.

- **LutMultA** simple lookup estimate of the reciprocal of the divisor followed by a multiplier. Only the remainder output type is supported because of the bias required in the reciprocal estimate. This bias would introduce an offset (error) if used to create a fractional output. This is recommended for operand widths less than or equal to 12 bits. This implementation uses DSP slices, block RAM, and a small number of FPGA logic primitives (registers and LUTs). For operand widths where either Radix2 or the LutMult options are possible, the LutMult offers a solution using fewer FPGA logic resources because of the use of DSP and block RAM primitives. Supports `unsigned` or two's complement `signed` numbers.
- **Output channel:**
 - **Remainder type:**
 - **Remainder:** Only supported for Radix 2.
 - **Fractional:** Determines the number of bits in the fractional port output.
 - **Fractional width:** If Fractional Remainder type is selected, this entry determines the number of bits in the fractional port output.
- **Radix2 Options:**
 - **Radix2 throughput:** Determines the interval in clocks between new data being input (and output). Choices are 1, 2, 4, and 8.
- **High Radix Options:**
 - **Detect divide by zero:** Determines if the core shall have a division-by-zero indication output port.
- **AXI Interface:**
 - **AXI behavior:**
 - **NonBlocking:** Performs an action only when a control packet and a data packet are presented to the block at the same time.
 - **Blocking:** Performs an action when a data packet is presented to the block. The block uses the previous control information.
 - **AXI Implementation emphasis:**
 - **Resources:** *Automatic* (fully pipelined) or *Manual* (determined by following field).
 - **Performance:** Implementation decisions target the highest speed.
- **Latency Options:**
 - **Latency configuration:** *Automatic* (fully pipelined) or *Manual* (determined by following field).

- **Latency:** This field determines the exact latency from input to output in terms of clock enabled clock cycles.
- **Optional ports tab:**
 - **Optional Ports:**
 - **Divided Channel Ports:**
 - **Has TUSER:** Adds a tuser input port to the dividend channel.
 - **Has TLAST:** Adds a tlast output port to the dividend channel.
 - **Divisor Channel Ports:**
 - **Has TUSER:** Adds a tuser input port to the divisor channel.
 - **Has TLAST:** Adds a tlast output port to the divisor channel.
 - **ACLKEN:** Specifies that the block has a clock enable port (the equivalent of selecting the Has ACLKEN option in the CORE Generator GUI).
 - **ARESETn:** Specifies that the block has a reset port. Active-Low synchronous clear. A minimum ARESETn pulse of two cycles is required.
 - **m_axis_dout_tready:** Specifies that the block has a dout_tready output port.
- **Input TLAST combination for output:** Determines the behavior of the dout_tlast output port.
 - **Null:** Output is null.
 - **Pass_Dividend_TLAST:** Pass the value of the dividend_tlast input port to the dout_tlast output port.
 - **Pass_Divisor_TLAST:** Pass the value of the divisor_tlast input port to the dout_tlast output port.
 - **OR_all_TLASTS:** Pass the logical OR of all the present TLAST input ports.
 - **AND_all_TLASTS:** Pass the logical AND of all the present TLAST input ports.

Other parameters used by this block are explained in the topic [Common Options in Block Parameter Dialog Boxes](#).

LogiCORE Documentation

[LogiCORE IP Divider Generator 5.1](#)

Down Sample

This block is listed in the following Xilinx® Blockset libraries: Basic Elements and Index.

The Xilinx Down Sample block reduces the sample rate at the point where the block is placed in your design.

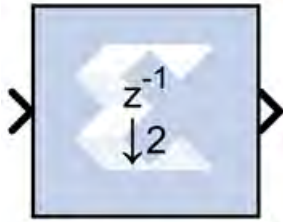

The input signal is sampled at even intervals, at either the beginning (first value), or end (last value) of a frame. The sampled value is presented on the output port and held until the next sample is taken.

A Down Sample frame consists of I input samples, where I is sampling rate. An example frame for a Down Sample block configured with a sampling rate of 4 is shown below.

Figure 21: Down Sample Block Example

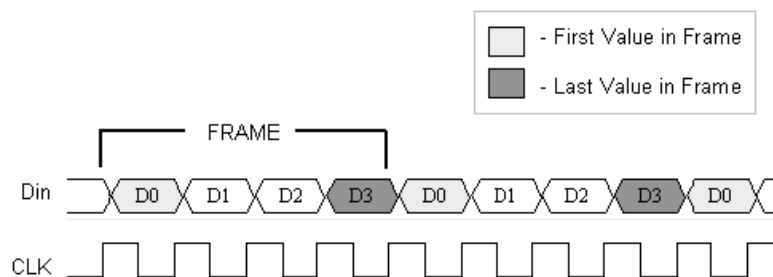

The Down Sample block is realized in hardware using one of three possible implementations that vary in terms of implementation efficiency. The block receives two clock enable signals in hardware, Src_CE, and Dest_CE. Src_CE is the faster clock enable signal and corresponds to the input data stream rate. Dest_CE is the slower clock enable, corresponding to the output stream rate, for example, down sampled data. These enable signals control the register sampling in hardware.

Zero Latency Down Sample

The zero latency Down Sample block must be configured to sample the first value of the frame. The first sample in the input frame passes through the mux to the output port. A register samples this value during the first sample duration and the mux switches to the register output at the start of the second sample of the frame. The result is that the first sample in a frame is present on the output port for the entire frame duration. This is the least efficient hardware implementation as the mux introduces a combinational path from Din to Dout. A single bit register adjusts the timing of the destination clock enable, so that it is asserted at the start of the sample period, instead of the end. The hardware implementation is shown below:

Figure 22: Down Sample with Zero Latency Example

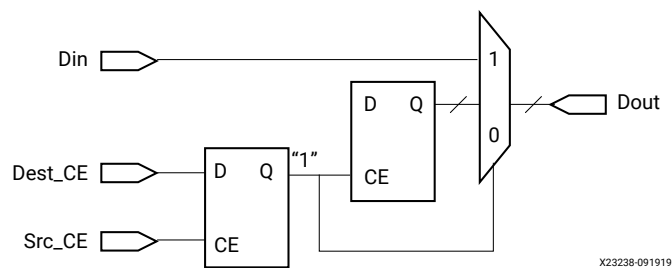

Down Sample with Latency

If the Down Sample block is configured with latency greater than zero, a more efficient implementation is used. One of two implementations is selected depending on whether the Down Sample block is set to sample the first or last value in a frame.

If the block samples the first value in a frame, two registers are required to correctly sample the input stream. The first register is enabled by the adjusted clock enable signal so that it samples the input at the start of the input frame. The second register samples the contents of the first register at the end of the sample period to ensure output data is aligned correctly.

Figure 23: Down Sample with Latency Example

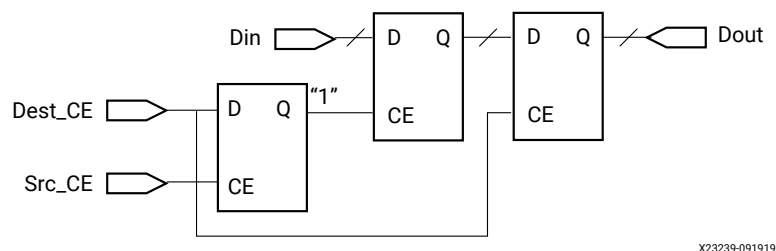

If the block samples the last value in a frame, a register samples the data input data at the end of the frame. The sampled value is presented for the duration of the next frame. The most efficient implementation is when the Down Sample block is configured to sample the last value of the frame.

Figure 24: Sampling Last Value

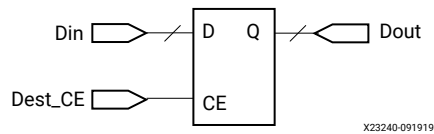

Block Parameters

The block parameters dialog box can be invoked by double-clicking the icon in your Simulink® model.

- **Basic tab:**
 - **Sampling Rate (number of input samples per output sample):** Must be an integer greater or equal to 2. This is the ratio of the output sample period to the input, and is essentially a sample rate divider. For example, a ratio of 2 indicates a 2:1 division of the input sample rate. If a non-integer ratio is desired, the Up Sample block can be used in combination with the Down Sample block.
 - **Sample:** The Down Sample block can sample either the first or last value of a frame. This parameter will determine which of these two values is sampled.

Other parameters used by this block are explained in the topic [Common Options in Block Parameter Dialog Boxes](#).

Xilinx LogiCORE

The Down Sample block does not use a Xilinx LogiCORE.

DSP48E

This block is listed in the following Xilinx® Blockset libraries: Index, DSP, and Math.

The Xilinx DSP48E block is an efficient building block for DSP applications that use supported devices. The DSP48E combines an 18-bit by 25-bit signed multiplier with a 48-bit adder and programmable mux to select the adder's input.

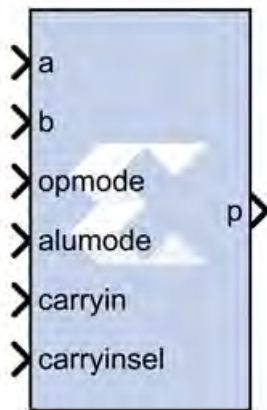

Operations can be selected dynamically. Optional input and multiplier pipeline registers can be selected as well as registers for the alumode, carryin and opmode ports. The DSP48E block can also target devices that do not contain the DSP48E hardware primitive if the **Use synthesizable** model option is selected on the implementation tab.

Figure 25: DSP48E

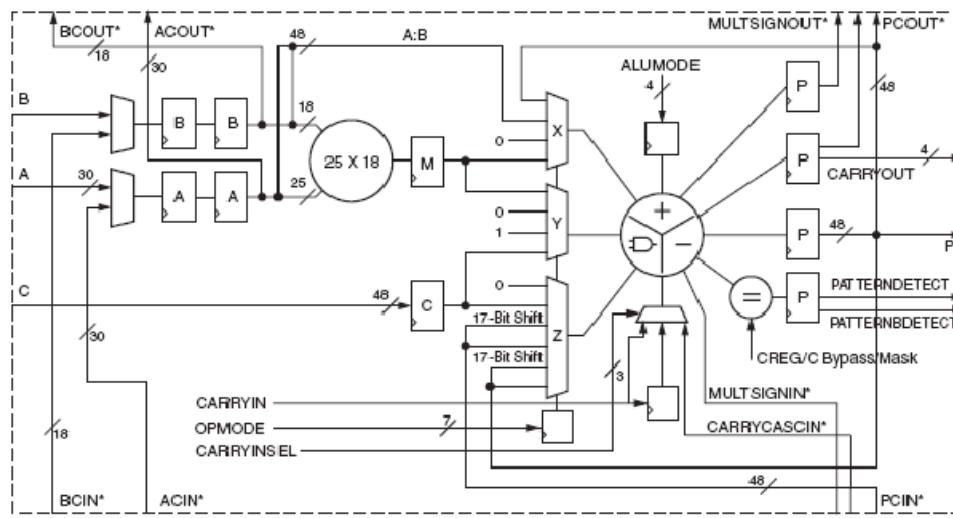

*These signals are dedicated routing paths internal to the DSP48E column. They are not accessible via fabric routing resources.

Block Parameters

The block parameters dialog box can be invoked by double-clicking the icon in your Simulink® model.

- **Basic tab:**

- **A or ACIN input:** Specifies if the A input should be taken directly from the a port or from the cascaded acin port. The acin port can only be connected to another DSP48 block.

- **B or BCIN input:** Specifies if the B input should be taken directly from the b port or from the cascaded bcin port. The bcin port can only be connected to another DSP48 block.
- **Pattern Detection:**
 - **Reset p register on pattern detection:** If selected and the pattern is detected, reset the p register on the next cycle
 - **Pattern Input:**
 - **Pattern Input from c port:** When selected, the pattern used in pattern detection is read from the c port.
 - **Using Pattern Attribute (48bit hex value):** Value is used in pattern detection logic which is best described as an equality check on the output of the adder/subtractor/logic unit.
 - **Pattern attribute:** A 48-bit value that is used in the pattern detector.
- **Mask Input:**
 - **Mask input from c port:** When selected, the mask used in pattern detection is read from the c port.
 - **Using Mask Attribute (48 bit hex value):** 48-bit value used to mask out certain bits during pattern detection.
 - **Mask attribute:** A 48-bit value and used to mask out certain bits during a pattern detection. A value of 0 passes the bit, and a value of 1 masks out the bit.48-bit value and used to mask out certain bits during a pattern detection.
- **Select rounding mask:** Selects special masks that can be used for symmetric or convergent rounding in the pattern detector. The choices are **Select mask**, **Mode1**, and **Mode2**.
- **Optional Ports tab:**
 - **Input Ports:**
 - **Consolidate control port:** When selected, combines the opmode, alumode, carry_in and carry_in_sel ports into one 15-bit port. Bits 0 to 6 are the opmode, bits 7 to 10 are the alumode port, bit 11 is the carry_in port, and bits 12 to 14 are the carry_in_sel port. This option should be used when the Opmode block is used to generate a DSP48E instruction.
 - **Provide c port:** When selected, the c port is made available. Otherwise, the c port is tied to '0'.
 - **Provide global reset port:** When selected, the port rst is made available. This port is connected to all available reset ports based on the pipeline selections.
 - **Provide global enable port:** When selected, the optional en port is made available. This port is connected to all available enable ports based on the pipeline selections.

- **Cascadable Ports:**
 - **Provide pcin port:** When selected, the pcin port is exposed. The pcin port must be connected to the pcout port of another DSP48 block.
 - **Provide carry cascade in port:** When selected, the carry cascade in port is exposed. This port can only be connected to a carry cascade out port on another DSP48E block.
 - **Provide multiplier sign cascade in port:** When selected, the multiplier sign cascade in port (multisigncascin) is exposed. This port can only be connected to a multiplier sign cascade out port of another DSP48E block.
- **Output Ports:**
 - **Provide carryout port:** When selected, the carryout output port is made available. When the mode of operation for the adder/subtractor is set to one 48-bit adder, the carryout port is 1-bit wide. When the mode of operation is set to two 24 bit adders, the carryout port is 2 bits wide. The MSB corresponds to the second adder's carryout and the LSB corresponds to the first adder's carryout. When the mode of operation is set to four 12 bit adders, the carryout port is 4 bits wide with the bits corresponding to the addition of the 48 bit input split into 4 12-bit sections.
 - **Provide pattern detect port:** When selected, the pattern detection output port is provided. When the pattern, either from the mask or the c register, is matched the pattern detection port is set to '1'.
 - **Provide pattern bar detect port:** When selected, the pattern bar detection (patternbdetect) output port is provided. When the inverse of the pattern, either from the mask or the c register, is matched the pattern bar detection port is set to '1'.
 - **Provide overflow port:** When selected, the overflow output port is provided. This port indicates when the operation in the DSP48E has overflowed beyond the bit P[N] where N is between 1 and 46. N is determined by the number of 1s in the mask whether set by the GUI mask field or the c port input.
 - **Provide underflow port:** When selected, the underflow output port is provided. This port indicates when the operation in the DSP48E has underflowed. Underflow occurs when the number goes below $-P[N]$ where N is determined by the number of 1s in the mask whether set by the GUI mask field or the c port input.
- **Cascadable Ports:**
 - **Provide ACOUT port:** When selected, the acout output port is made available. The acout port must be connected to the acin port of another DSP48E block.
 - **Provide BCOUT port:** When selected, the bcout output port is made available. The bcout port must be connected to the bcin port of another DSP48E block.
 - **Provide PCOUT port:** when selected, the pcout output port is made available. The pcout port must be connected to the pcin port of another DSP48 block.

- **Provide multiplier sign cascade out port:** When selected, the multiplier sign cascade out port (multsigncascout) is made available. This port can only be connected to the multiplier sign cascade in port of another DSP48E block and is used to support 96-bit accumulators/adders and subtracters which are built from two DSP48Es.
- **Provide carry cascade out port:** When selected, the carry cascade out port (carrycascout) is made available. This port can only be connected to the carry cascade in port of another DSP48E block.
- **Pipelining tab:**
 - **Pipeline Options:**
 - **Length of a/acin pipeline:** Specifies the length of the pipeline on input register A. A pipeline of length 0 removes the register on the input.
 - **Length of b/bcin pipeline:** Specifies the length of the pipeline for the b input whether it is read from b or bcin.
 - **Length of acout pipeline:** Specifies the length of the pipeline between the a/acin input and the acout output port. A pipeline of length 0 removes the register from the acout pipeline length. Must be less than or equal to the length of the a/acin pipeline.
 - **Length of bcout pipeline:** Specifies the length of the pipeline between the b/bcin input and the bcout output port. A pipeline of length 0 removes the register from the bcout pipeline length. Must be less than or equal to the length of the b/bcin pipeline.
 - **Pipeline c:** Indicates whether the input from the c port should be registered.
 - **Pipeline p:** Indicates whether the outputs p and pcout should be registered.
 - **Pipeline multiplier:** indicates whether the internal multiplier should register its output.
 - **Pipeline opmode:** Indicates whether the opmode port should be registered.
 - **Pipeline alumode:** Indicates whether the alumode port should be registered.
 - **Pipeline carry in:** Indicates whether the carry in port should be registered.
 - **Pipeline carry in select:** Indicates whether the carry in select port should be registered.
 - **Reset/Enable Ports tab:**
 - **Reset port for a/acin:** When selected, a port rst_a is made available. This resets the pipeline register for port a when set to '1'.
 - **Reset port for b/bcin:** When selected, a port rst_b is made available. This resets the pipeline register for port b when set to '1'.
 - **Reset port for c:** When selected, a port rst_c is made available. This resets the pipeline register for port c when set to '1'.

- **Reset port for multiplier:** when selected, a port `rst_m` is made available. This resets the pipeline register for the internal multiplier when set to '1'.
- **Reset port for P:** When selected, a port `rst_p` is made available. This resets the output register when set to '1'.
- **Reset port for carry in:** When selected, a port `rst_carryin` is made available. This resets the pipeline register for carry in when set to '1'.
- **Reset port for alumode:** When selected, a port `rst_alumode` is made available. This resets the pipeline register for the alumode port when set to '1'.
- **Reset port for controls (opmode and carry_in_sel):** When selected, a port `rst_ctrl` is made available. This resets the pipeline register for the opmode register (if available) and the `carry_in_sel` register (if available) when set to '1'.
- **Enable port for first a/acin register:** When selected, an enable port `ce_a1` for the first a pipeline register is made available.
- **Enable port for second a/acin register:** When selected, an enable port `ce_a2` for the second a pipeline register is made available.
- **Enable port for first b/bcin register:** When selected, an enable port `ce_b1` for the first b pipeline register is made available.
- **Enable port for second b/bcin register:** When selected, an enable port `ce_b2` for the second b pipeline register is made available.
- **Enable port for c:** When selected, an enable port `ce_c` for the port C register is made available.
- **Enable port for multiplier:** When selected, an enable port `ce_m` for the multiplier register is made available.
- **Enable port for p:** When selected, an enable port `ce_p` for the port P output register is made available.
- **Enable port for carry in:** When selected, an enable port `ce_carry_in` for the carry in register is made available.
- **Enable port for alumode:** When selected, an enable port `ce_alumode` for the alumode register is made available.
- **Enable port for multiplier carry in:** When selected, an enable port `mult_carry_in` for the multiplier register is made available.
- **Enable port for controls (opmode and carry_in_sel):** When selected, the enable port `ce_ctrl` is made available. The port `ce_ctrl` controls the opmode and carry in select registers.
- **Implementation tab:**

- **Use synthesizable model:** When selected, the DSP48E is implemented from an RTL description which might not map directly to the DSP48E hardware. This is useful if a design using the DSP48E block is targeted at device families that do not contain DSP48E hardware primitives.
- **Mode of operation for the adder/subtractor:** This mode can be used to implement small add-subtract functions at high speed and lower power with less logic utilization. The adder and subtractor in the adder/subtracted/logic unit can also be split into two 24-bit fields or four 12-bit fields. This is achieved by setting the mode of operation to "Two 24-bit adders" or "Four 12-bit adders".
- **Use adder only:** When selected, the block is optimized in hardware for maximum performance without using the multiplier. If an instruction using the multiplier is encountered in simulation, an error is reported.

Other parameters used by this block are explained in the topic [Common Options in Block Parameter Dialog Boxes](#).

DSP Macro 1.0

This block is listed in the following Xilinx® Blockset libraries: Index, DSP, and Math.

The System Generator DSP macro block provides a device independent abstraction of the DSP48E1, DSP48E2, and DSP58 blocks. Using this block instead of using a technology-specific DSP slice helps makes the design more portable between Xilinx technologies.

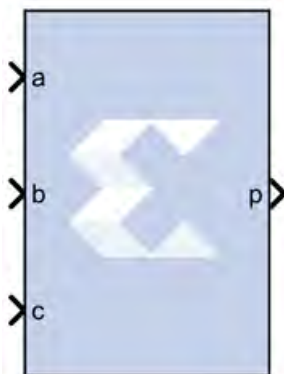

The DSP Macro provides a simplified interface to the XtremeDSP slice by the abstraction of all opmode, subtract, alumode, and inmode controls to a single SEL port. Further, all CE and RST controls are grouped to a single CE and SCLR port respectively. This abstraction enhances portability of HDL between device families.

You can specify 1 to 64 instructions which are translated into the various control signals for the XtremeDSP slice of the target device. The instructions are stored in a ROM from which the appropriate instruction is selected using the SEL port.

Block Parameters

- **Instruction tab:**

The Instruction tab is used to define the operations that the LogiCORE™ is to implement. Each instruction can be entered on a new line, or in a comma delimited list, and are enumerated from the top down. You can specify a maximum of 64 instructions.

Refer to the topic Instructions page of the [LogiCORE IP DSP Macro 1.0 Product Guide](#) for details on all the parameters on this tab.

- **Pipeline Options tab:**

The Pipeline Options tab is used to define the pipeline depth of the various input paths.

- **Pipeline Options:**

Specifies the pipeline method to be used; **Automatic**, **By Tier**, or **Expert**.

- **Custom Pipeline options:**

Used to specify the pipeline depth of the various input paths.

- **Tier 1 to 6:** When **By Tier** is selected for Pipeline Options these parameters are used to enable/disable the registers across all the input paths for a given pipeline stage. The following restrictions are enforced:

- When P has been specified in an expression tier, 6 will be forced as asynchronous feedback is not supported.

- **Individual registers:**

When you select **Expert** for the Pipeline Options, these parameters are used to enable/disable individual register stages. The following restrictions are enforced:

- The P register is forced when P is specified in an expression. Asynchronous feedback is not supported.

Refer to the topic Detailed Pipeline Implementation of the [LogiCORE IP DSP Macro v1.0 Product Guide](#) for details on all the parameters on this tab.

- **Implementation tab:**

The Implementation tab is used to define implementation options.

- **Output Port Properties:**

- **Precision:** Specifies the precision of the P output port.
 - **Full:** The bit width of the output port P is set to the full XtremeDSP Slide width of 48 bits.
 - **User_Defined:** The output width of P can be set to any value up to 48 bits. When set to less than 48 bits, the output is truncated (LSBs removed).
- **Width:** Specifies the User Defined output width of the P output port
- **Binary Point:** Specifies the placement of the binary point of the P output port.
- **Additional ports:**
 - **Use ACOUT:** Use the optional cascade A output port.
 - **Use CARRYOUT:** Use the optional carryout output port.
 - **Use BCOUT:** Use the optional cascade B output port.
 - **Use CARRYCASCOUT:** Use the optional cascade carryout output port.
 - **Use PCOUT:** Use the optional cascade P output port.
- **Control ports:**

Refer to the topic Implementation Page of the [LogiCORE IP DSP Macro v1.0 Product Guide](#) for details on all the parameters on this tab.

LogiCORE Documentation

[LogiCORE IP DSP Macro v1.0 Product Guide](#)

DSP48E1

This block is listed in the following Xilinx® Blockset libraries: Index, DSP.

The Xilinx DSP48E1 block is an efficient building block for DSP applications that use Xilinx Virtex®-7 series devices. Enhancements to the DSP48E1 slice provide improved flexibility and utilization, improved efficiency of applications, reduced overall power consumption, and increased maximum frequency. The high performance allows designers to implement multiple slower operations in a single DSP48E1 slice using time-multiplexing methods.

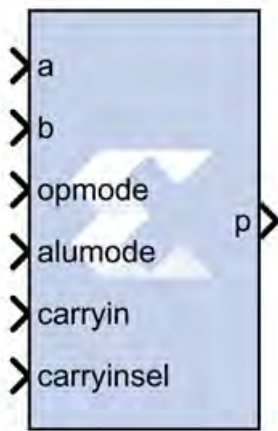

The DSP48E1 slice supports many independent functions. These functions include multiply, multiply accumulate (MACC), multiply add, three-input add, barrel shift, wide-bus multiplexing, magnitude comparator, bit-wise logic functions, pattern detect, and wide counter. The architecture also supports cascading multiple DSP48E1 slices to form wide math functions, DSP filters, and complex arithmetic without the use of general FPGA.

Figure 26: **DSP48E1**

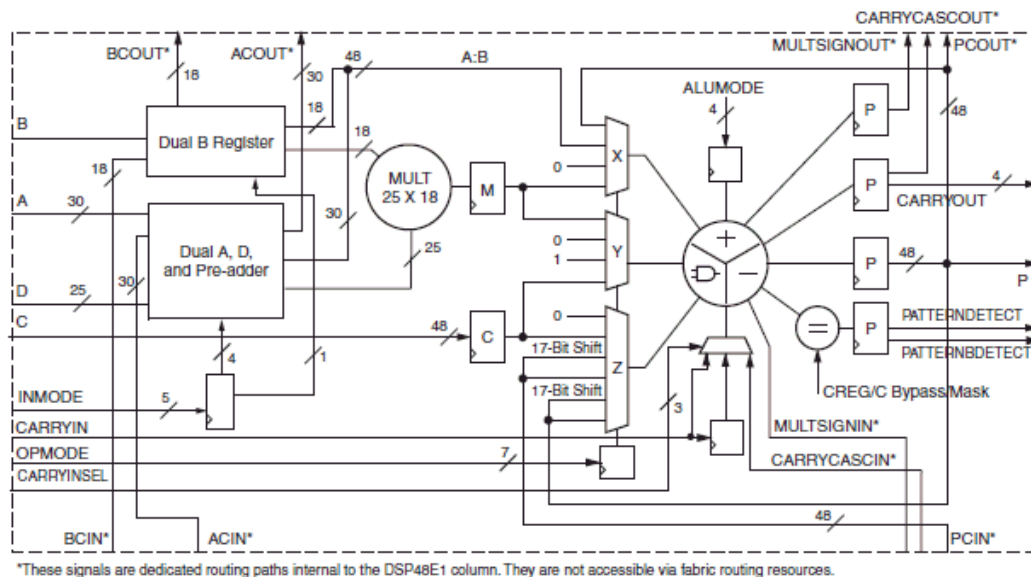

Block Parameters

The block parameters dialog box can be invoked by double-clicking the icon in your Simulink® model.

- **Basic tab:**

Parameters specific to the Basic tab are as follows.

- **Input configuration:**
 - **A or ACIN input:** Specifies if the A input should be taken directly from the a port or from the cascaded `ac_in` port. The `ac_in` port can only be connected to another DSP48 block.
 - **B or BCIN input:** Specifies if the B input should be taken directly from the b port or from the cascaded `bc_in` port. The `bc_in` port can only be connected to another DSP48 block.
- **DSP48E1 data-path configuration:**
 - **SIMD Mode of Adder/Subtractor/Accumulator:** This mode can be used to implement small add-subtract functions at high speed and lower power with less logic utilization. The adder and subtracter in the adder/subtractor/logic unit can also be split into **Two 24-bit Units** or **Four 12-bit Units**.
 - **Do not use multiplier:** When selected, the block is optimized in hardware for maximum performance without using the multiplier. If an instruction using the multiplier is encountered in simulation, an error is reported.
 - **Use dynamic multiplier mode:** When selected, it instructs the block to use the dynamic multiplier mode. This indicates that the block is switching between $A*B$ and $A:B$ operations on the fly and therefore needs to get the worst-case timing of the two paths.
 - **Use Preadder:** Use the 25-bit D data input to the pre-adder or alternative input to the multiplier. The pre-adder implements $D + A$ as determined by the `INMODE3` signal.
- **Pattern Detection:**
 - **Reset p register on pattern detection:** If selected and the pattern is detected, reset the p register on the next cycle
- **Pattern Input:**
 - **Pattern Input from c port:** When selected, the pattern used in pattern detection is read from the c port.
 - **Pattern Input:**
 - **Pattern Input from c port:** When selected, the pattern used in pattern detection is read from the c port.
 - **Using Pattern Attribute (48bit hex value):** Value is used in pattern detection logic which is best described as an equality check on the output of the adder/subtractor/logic unit
 - **Pattern attribute:** A 48-bit value that is used in the pattern detector.
 - **Mask Input:**
 - **Mask input from c port:** When selected, the mask used in pattern detection is read from the c port.

- **Using Mask Attribute (48 bit hex value):** Enter a 48-bit value used to mask out certain bits during pattern detection.
- **MODE1:** Selects rounding_mode 1.
- **MODE2:** Selects rounding_mode 2.
- **Optional Ports tab:**

Parameters specific to the Optional Ports tab are:

- **Input Ports:**
 - **Consolidate control port:** When selected, combines the `opmode`, `alumode`, `carry_in`, `carry_in_sel`, and `inmode` ports into one 20-bit port. Bits 0 to 6 are the `opmode`, bits 7 to 10 are the `alumode` port, bit 11 is the `carry_in` port, bits 12 to 14 are the `carry_in_sel` port, and bits 15-19 are the `inmode` bits. This option should be used when the `Opmode` block is used to generate a DSP48 instruction.
 - **Provide c port:** When selected, the `c` port is made available. Otherwise, the `c` port is tied to '0'.
 - **Provide global reset port:** When selected, the port `rst` is made available. This port is connected to all available reset ports based on the pipeline selections.
 - **Provide global enable port:** When selected, the optional `en` port is made available. This port is connected to all available enable ports based on the pipeline selections.
 - **Provide pcin port:** When selected, the `pcin` port is exposed. The `pcin` port must be connected to the `pcout` port of another DSP48 block.
 - **Provide carry cascade in port:** When selected, the carry cascade in port is exposed. This port can only be connected to a carry cascade out port on another DSP48E block.
 - **Provide multiplier sign cascade in port:** When selected, the multiplier sign cascade in port (`multsigncascin`) is exposed. This port can only be connected to a multiplier sign cascade out port of another DSP48E block.
 - **Provide carryout port:** When selected, the `carryout` output port is made available. When the mode of operation for the adder/subtractor is set to one 48-bit adder, the `carryout` port is 1-bit wide. When the mode of operation is set to two 24 bit adders, the `carryout` port is 2 bits wide. The MSB corresponds to the second adder's carryout and the LSB corresponds to the first adder's carryout. When the mode of operation is set to four 12 bit adders, the `carryout` port is 4 bits wide with the bits corresponding to the addition of the 48 bit input split into 4 12-bit sections.
 - **Provide pattern detect port:** When selected, the pattern detection output port is provided. When the pattern, either from the mask or the `c` register, is matched the pattern detection port is set to '1'.

- **Provide pattern bar detect port:** When selected, the pattern bar detection (patternbdetect) output port is provided. When the inverse of the pattern, either from the mask or the c register, is matched the pattern bar detection port is set to '1'.
 - **Provide overflow port:** When selected, the overflow output port is provided. This port indicates when the operation in the DSP48E has overflowed beyond the bit P[N] where N is between 1 and 46. N is determined by the number of 1s in the mask whether set by the GUI mask field or the c port input.
 - **Provide underflow port:** When selected, the underflow output port is provided. This port indicates when the operation in the DSP48E has underflowed. Underflow occurs when the number goes below -P[N] where N is determined by the number of 1s in the mask whether set by the GUI mask field or the c port input.
 - **Provide acout port:** When selected, the acout output port is made available. The acout port must be connected to the acin port of another DSP48E block.
 - **Provide bcout port:** When selected, the bcout output port is made available. The bcout port must be connected to the bcin port of another DSP48E block.
 - **Provide pcout port:** When selected, the pcout output port is made available. The pcout port must be connected to the pcin port of another DSP48 block.
 - **Provide multiplier sign cascade out port:** When selected, the multiplier sign cascade out port (multsigncascout) is made available. This port can only be connected to the multiplier sign cascade in port of another DSP48E block and is used to support 96-bit accumulators/adders and subtracters which are built from two DSP48Es.
 - **Provide carry cascade out port:** When selected, the carry cascade out port (carrycascout) is made available. This port can only be connected to the carry cascade in port of another DSP48E block.
- **Pipelining tab:**

Parameters specific to the Pipelining tab are as follows.

- **Length of a/acin pipeline:** Specifies the length of the pipeline on input register A. A pipeline of length 0 removes the register on the input.
- **Length of b/bcin pipeline:** Specifies the length of the pipeline for the b input whether it is read from b or bcin.
- **Length of acout pipeline:** Specifies the length of the pipeline between the a/acin input and the acout output port. A pipeline of length 0 removes the register from the acout pipeline length. Must be less than or equal to the length of the a/acin pipeline.
- **Length of bcout pipeline:** Specifies the length of the pipeline between the b/bcin input and the bcout output port. A pipeline of length 0 removes the register from the bcout pipeline length. Must be less than or equal to the length of the b/bcin pipeline.
- **Pipeline c:** Indicates whether the input from the c port should be registered.

- **Pipeline p:** Indicates whether the outputs p and pcout should be registered.
- **Pipeline multiplier:** Indicates whether the internal multiplier should register its output.
- **Pipeline opmode:** Indicates whether the opmode port should be registered.
- **Pipeline alumode:** Indicates whether the alumode port should be registered.
- **Pipeline carry in:** Indicates whether the carry in port should be registered.
- **Pipeline carry in select:** Indicates whether the carry in select port should be registered.
- **Pipeline preadder input register d:** Indicates to add a pipeline register to the d input.
- **Pipeline preadder output register ad:** Indicates to add a pipeline register to the ad output.
- **Pipeline INMODE register:** Indicates to add a pipeline register to the INMODE input.
- **Reset/Enable Ports:** Parameters specific to the Reset/Enable tab are as follows.
 - **Provide Reset Ports:**
 - **Reset port for a/acin:** When selected, a port rst_a is made available. This resets the pipeline register for port a when set to '1'.
 - **Reset port for b/bcin:** When selected, a port rst_b is made available. This resets the pipeline register for port b when set to '1'.
 - **Reset port for c:** When selected, a port rst_c is made available. This resets the pipeline register for port c when set to '1'.
 - **Reset port for multiplier:** When selected, a port rst_m is made available. This resets the pipeline register for the internal multiplier when set to '1'.
 - **Reset port for P:** When selected, a port rst_p is made available. This resets the output register when set to '1'.
 - **Reset port for carry in:** When selected, a port rst_carryin is made available. This resets the pipeline register for carry in when set to '1'.
 - **Reset port for alumode:** When selected, a port rst_alumode is made available. This resets the pipeline register for the alumode port when set to '1'.
 - **Reset port for controls (opmode and carry_in_sel):** When selected, a port rst_ctrl is made available. This resets the pipeline register for the opmode register (if available) and the carry_in_sel register (if available) when set to '1'.
 - **Reset port for d and ad:**
 - **Reset port for INMODE:**
- **Provide Enable Ports:**

- **Enable port for first a/acin register:** When selected, an enable port ce_a1 for the first a pipeline register is made available.
- **Enable port for second a/acin register:** When selected, an enable port ce_a2 for the second a pipeline register is made available.
- **Enable port for first b/bcin register:** When selected, an enable port ce_b1 for the first b pipeline register is made available.
- **Enable port for second b/bcin register:** When selected, an enable port ce_b2 for the second b pipeline register is made available.
- **Enable port for c:** When selected, an enable port ce_c for the port C register is made available.
- **Enable port for multiplier:** When selected, an enable port ce_m for the multiplier register is made available.
- **Enable port for p:** When selected, an enable port ce_p for the port P output register is made available.
- **Enable port for carry in:** When selected, an enable port ce_carry_in for the carry in register is made available.
- **Enable port for alumode:** When selected, an enable port ce_alumode for the alumode register is made available.
- **Enable port for multiplier carry in:** When selected, an enable port mult_carry_in for the multiplier register is made available.
- **Enable port for controls (opmode and carry_in_sel):** When selected, the enable port ce_ctrl is made available. The port ce_ctrl controls the opmode and carry in select registers.
- **Enable port for d:** When selected, an enable port is added input register d.
- **Enable port for ad:** When selected, an enable port is add for the preadder output register ad.
- **Enable port for INMODE:** When selected, an enable port is added for the INMODE register.

- **Implementation:**

Parameters specific to the Implementation tab are as follows.

- **Use synthesizable model:** When selected, the DSP48E is implemented from an RTL description which might not map directly to the DSP48E hardware. This is useful if a design using the DSP48E block is targeted at device families that do not contain DSP48E hardware primitives.

Other parameters used by this block are explained in the topic [Common Options in Block Parameter Dialog Boxes](#).

DSP48E2

This block is listed in the following Xilinx® Blockset libraries: Index, DSP.

The Xilinx DSP48E2 block is an efficient building block for DSP applications that use UltraScale devices. DSP applications use many binary multipliers and accumulators that are best implemented in dedicated DSP resources. UltraScale devices have many dedicated low-power DSP slices, combining high speed with small size while retaining system design flexibility.

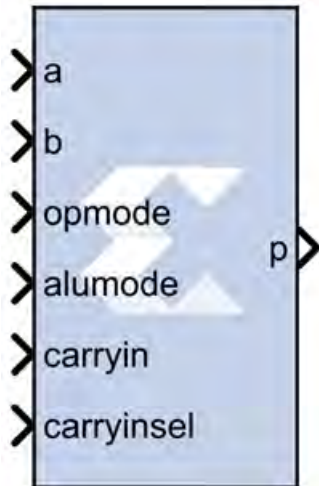

The DSP48E2 slice is effectively a superset of the DSP48E1 slice with these differences:

- Wider functionality
- More flexibility in the pre-adder
- Added fourth operand to ALU with WMUX
- Wide XOR of the X, Y, and Z multiplexers
- Additional unique features

Refer to the document titled *UltraScale Architecture DSP Slice User Guide* ([UG579](#)) for a detailed description of the DSP48E2 features.

Figure 27: DSP48E2

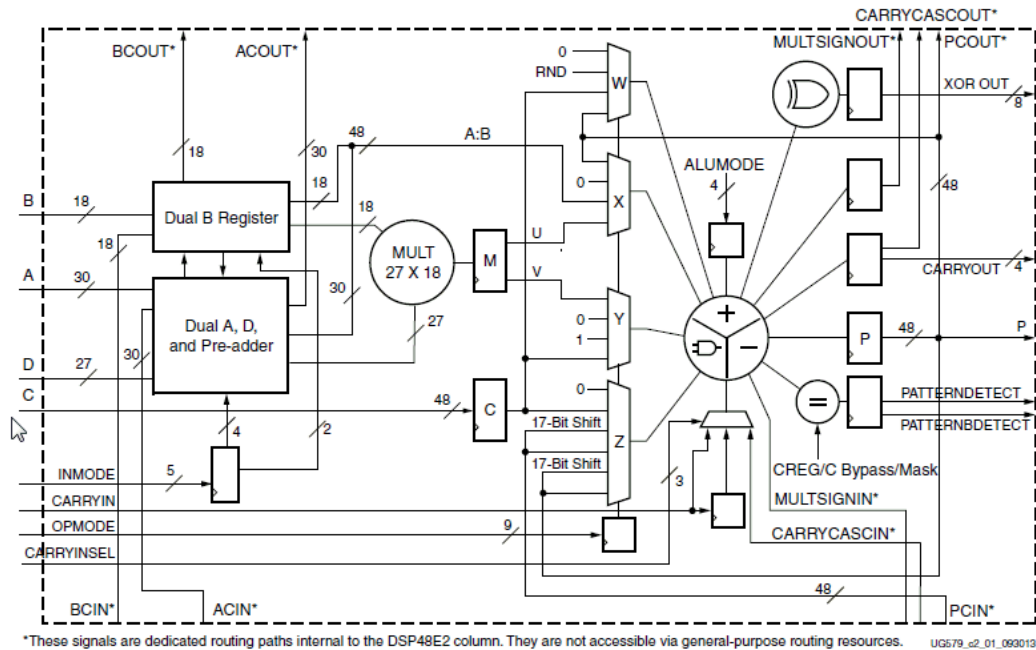

Block Parameters

The block parameters dialog box can be invoked by double-clicking the icon in your Simulink® model.

- **Basic tab:** Parameters specific to the Basic tab are as follows.
 - **Input configuration:**
 - **A or ACIN input:** Specifies if the A input should be taken directly from the a port or from the cascaded `ac_in` port. The `ac_in` port can only be connected to another DSP48 block.
 - **B or BCIN input:** Specifies if the B input should be taken directly from the b port or from the cascaded `bc_in` port. The `bc_in` port can only be connected to another DSP48 block.
 - **DSP48E2 data-path configuration:**
 - **SIMD Mode of Adder/Subtractor/Accumulator:** This mode can be used to implement small add-subtract functions at high speed and lower power with less logic utilization. The adder and subtractor in the adder/subtracted/logic unit can also be split into **Two 24-bit Units** or **Four 12-bit Units**.
 - **Do not use multiplier:** When selected, the block is optimized in hardware for maximum performance without using the multiplier. If an instruction using the multiplier is encountered in simulation, an error is reported.

- **Use dynamic multiplier mode:** When selected, it instructs the block to use the dynamic multiplier mode. This indicates that the block is switching between $A*B$ and $A:B$ operations on the fly and therefore needs to get the worst-case timing of the two paths.
- **Preadder configuration:** Use the 25-bit D data input to the pre-adder or alternative input to the multiplier. The pre-adder implements $D + A$ as determined by the INMODE3 signal.
 - **PREADDINSEL Select preadder input:** Selects the input to be added with D in the preadder.
 - **AMULTSEL Select A multiplexer output:** Selects the input to the 27-bit A input of the multiplier. In the 7 series primitive DSP48E1 the attribute is called USE_DPORT, but has been renamed due to new pre-adder flexibility enhancements (default AMULTSEL = A is equivalent to USE_DPORT=FALSE).
 - **BMULTSEL Select B multiplexer output:** Selects the input to the 18-bit B input of the multiplier.
 - **Enable D Port:** Automatically enabled when AD is selected above.
- **Pattern Detection:**
 - **Reset p register on pattern detection:** If selected and the pattern is detected, reset the p register on the next cycle.
 - **AUTO RESET PRIORITY:** When enabled by selecting the option above, select RESET (the default) or CEP (clock enabled for the P (output) register).
- **Pattern Input:**
 - **Pattern Input from c port:** When selected, the pattern used in pattern detection is read from the c port.
 - **Using Pattern Attribute (48bit hex value):** Value is used in pattern detection logic which is best described as an equality check on the output of the adder/subtractor/logic unit.
 - **Pattern Attribute (48bit hex value):** Enter a 48-bit value that is used in the pattern detector.
- **Mask Input:**
 - **Mask input from c port:** When selected, the mask used in pattern detection is read from the c port.
 - **Using Mask Attribute (48 bit hex value):** Enter a 48-bit value used to mask out certain bits during pattern detection.
 - **MODE1:** Selects rounding_mode 1 (C-bar left shifted by 1).
 - **MODE2:** Selects rounding_mode 2 (C-bar left shifted by 2).
- **Wide Xor tab:** Parameters specific to the Wide Xor tab are as follows.

- **Use Wide XOR:** This is a new feature in the DSP48E2 slice giving the ability to perform a 96-bit wide XOR function.
- **XORSIMD Select Wide XOR SIMD:** The XORSIMD attribute is used to select the width of the XOR function. Select either XOR12 (the default), XOR24, XOR48, or XOR96.
- **Optional Ports tab:** Parameters specific to the Optional Ports tab are as follows.
 - **Input Ports:**
 - **Consolidate control port:** When selected, combines the `opmode`, `alumode`, `carry_in`, `carry_in_sel`, and `inmode` ports into one 20-bit port. Bits 0 to 6 are the `opmode`, bits 7 to 10 are the `alumode` port, bit 11 is the `carry_in` port, bits 12 to 14 are the `carry_in_sel` port, and bits 15-19 are the `inmode` bits. This option should be used when the `Opmode` block is used to generate a DSP48 instruction.
 - **Provide c port:** When selected, the `c` port is made available. Otherwise, the `c` port is tied to '0'.
 - **Provide global reset port:** When selected, the port `rst` is made available. This port is connected to all available reset ports based on the pipeline selections.
 - **Provide global enable port:** When selected, the optional `en` port is made available. This port is connected to all available enable ports based on the pipeline selections.
 - **Cascadable Ports:**
 - **Provide pcin port:** When selected, the `pcin` port is exposed. The `pcin` port must be connected to the `pcout` port of another DSP48 block.
 - **Provide carry cascade in port:** When selected, the carry cascade in port is exposed. This port can only be connected to a carry cascade out port on another DSP48E block.
 - **Provide multiplier sign cascade in port:** When selected, the multiplier sign cascade in port (`multsigncascin`) is exposed. This port can only be connected to a multiplier sign cascade out port of another DSP48E block.
- **Output Ports:**
 - **Provide carryout port:** When selected, the `carryout` output port is made available. When the mode of operation for the adder/subtractor is set to one 48-bit adder, the `carryout` port is 1-bit wide. When the mode of operation is set to two 24 bit adders, the `carryout` port is 2 bits wide. The MSB corresponds to the second adder's carryout and the LSB corresponds to the first adder's carryout. When the mode of operation is set to four 12 bit adders, the `carryout` port is 4 bits wide with the bits corresponding to the addition of the 48 bit input split into 4 12-bit sections.
 - **Provide pattern detect port:** When selected, the pattern detection output port is provided. When the pattern, either from the mask or the `c` register, is matched the pattern detection port is set to '1'.

- **Provide pattern bar detect port:** When selected, the pattern bar detection (patternbdetect) output port is provided. When the inverse of the pattern, either from the mask or the c register, is matched the pattern bar detection port is set to '1'.
- **Provide overflow port:** When selected, the overflow output port is provided. This port indicates when the operation in the DSP48E has overflowed beyond the bit P[N] where N is between 1 and 46. N is determined by the number of 1s in the mask whether set by the GUI mask field or the c port input.
- **Provide underflow port:** When selected, the underflow output port is provided. This port indicates when the operation in the DSP48E has underflowed. Underflow occurs when the number goes below -P[N] where N is determined by the number of 1s in the mask whether set by the GUI mask field or the c port input.
- **Cascadable Ports:**
 - **Provide acout port:** When selected, the acout output port is made available. The acout port must be connected to the acin port of another DSP48E block.
 - **Provide bcout port:** When selected, the bcout output port is made available. The bcout port must be connected to the bcin port of another DSP48E block.
 - **Provide pcout port:** When selected, the pcout output port is made available. The pcout port must be connected to the pcin port of another DSP48E block.
 - **Provide multiplier sign cascade out port:** When selected, the multiplier sign cascade out port (multsigncascout) is made available. This port can only be connected to the multiplier sign cascade in port of another DSP48E block and is used to support 96-bit accumulators/adders and subtracters which are built from two DSP48Es.
 - **Provide carry cascade out port:** When selected, the carry cascade out port (carrycascout) is made available. This port can only be connected to the carry cascade in port of another DSP48E block.

- **Pipelining tab:**

Parameters specific to the Pipelining tab are as follows.

- **Length of a/acin pipeline:** Specifies the length of the pipeline on input register A. A pipeline of length 0 removes the register on the input.
- **Length of b/bcin pipeline:** Specifies the length of the pipeline for the b input whether it is read from b or bcin.
- **Length of acout pipeline:** Specifies the length of the pipeline between the a/acin input and the acout output port. A pipeline of length 0 removes the register from the acout pipeline length. Must be less than or equal to the length of the a/acin pipeline.
- **Length of bcout pipeline:** Specifies the length of the pipeline between the b/bcin input and the bcout output port. A pipeline of length 0 removes the register from the bcout pipeline length. Must be less than or equal to the length of the b/bcin pipeline.

- **Pipeline c:** Indicates whether the input from the c port should be registered.
- **Pipeline p:** Indicates whether the outputs p and pcout should be registered.
- **Pipeline multiplier:** Indicates whether the internal multiplier should register its output.
- **Pipeline opmode:** Indicates whether the opmode port should be registered.
- **Pipeline alumode:** Indicates whether the alumode port should be registered.
- **Pipeline carry in:** Indicates whether the carry in port should be registered.
- **Pipeline carry in select:** Indicates whether the carry in select port should be registered.
- **Pipeline preadder input register d:** Indicates to add a pipeline register to the d input.
- **Pipeline preadder output register ad:** Indicates to add a pipeline register to the ad output.
- **Pipeline INMODE register:** Indicates to add a pipeline register to the INMODE input.
- **Reset/Enable Ports tab:** Parameters specific to the Reset/Enable tab are as follows.
 - **Provide Reset Ports:**
 - **Reset port for a/acin:** When selected, a port rst_a is made available. This resets the pipeline register for port a when set to '1'.
 - **Reset port for b/bcin:** When selected, a port rst_b is made available. This resets the pipeline register for port b when set to '1'.
 - **Reset port for c:** When selected, a port rst_c is made available. This resets the pipeline register for port c when set to '1'.
 - **Reset port for multiplier:** When selected, a port rst_m is made available. This resets the pipeline register for the internal multiplier when set to '1'.
 - **Reset port for P:** When selected, a port rst_p is made available. This resets the output register when set to '1'.
 - **Reset port for carry in:** When selected, a port rst_carryin is made available. This resets the pipeline register for carry in when set to '1'.
 - **Reset port for alumode:** When selected, a port rst_alumode is made available. This resets the pipeline register for the alumode port when set to '1'.
 - **Reset port for controls (opmode and carry_in_sel):** When selected, a port rst_ctrl is made available. This resets the pipeline register for the opmode register (if available) and the carry_in_sel register (if available) when set to '1'.
 - **Reset port for d and ad:** When selected, a port rst_a and rst_ad is made available. This resets the pipeline register for ports when set to '1'.

- **Reset port for INMODE:** When selected, a port `rst_inmode` is made available. This resets the pipeline register for the inmode port when set to '1'.
- **Provide Enable Ports:**
 - **Enable port for first a/acin register:** When selected, an enable port `ce_a1` for the first a pipeline register is made available.
 - **Enable port for second a/acin register:** When selected, an enable port `ce_a2` for the second a pipeline register is made available.
 - **Enable port for first b/bcin register:** When selected, an enable port `ce_b1` for the first b pipeline register is made available.
 - **Enable port for second b/bcin register:** When selected, an enable port `ce_b2` for the second b pipeline register is made available.
 - **Enable port for c:** When selected, an enable port `ce_c` for the port C register is made available.
 - **Enable port for multiplier:** When selected, an enable port `ce_m` for the multiplier register is made available.
 - **Enable port for p:** When selected, an enable port `ce_p` for the port P output register is made available.
 - **Enable port for carry in:** When selected, an enable port `ce_carry_in` for the carry in register is made available.
 - **Enable port for alumode:** When selected, an enable port `ce_alumode` for the alumode register is made available.
 - **Enable port for multiplier carry in:** When selected, an enable port `mult_carry_in` for the multiplier register is made available.
 - **Enable port for controls (opmode and carry_in_sel):** When selected, the enable port `ce_ctrl` is made available. The port `ce_ctrl` controls the opmode and carry in select registers.
 - **Enable port for d:** When selected, an enable port is added input register d.
 - **Enable port for ad:** When selected, an enable port is add for the preadder output register ad.
 - **Enable port for INMODE:** When selected, an enable port is added for the INMODE register.
- **Inversion Options tab:** When a checkbox is selected on this tab, the specified signal is inverted.
- **Implementation tab:** Parameters specific to the Implementation tab are as follows.

- **Use synthesizable model:** When selected, the DSP48E2 is implemented from an RTL description which might not map directly to the DSP48E2 hardware. This is useful if a design using the DSP48E2 block is targeted at device families that do not contain DSP48E2 hardware primitives.

Other parameters used by this block are explained in the topic [Common Options in Block Parameter Dialog Boxes](#).

DSP58

This block is listed in the following Xilinx® Blockset libraries: Index, and DSP.

The Xilinx DSP58 block is an efficient building block for DSP applications that use Versal™ devices. DSP applications use many binary multipliers and accumulators that are best implemented in dedicated DSP resources. Versal™ devices have many dedicated low-power DSP slices, combining high speed with small size while retaining system design flexibility.

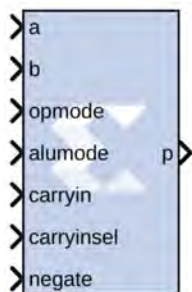

The DSP58 slice is effectively a super-set of the DSP48E2 slice with these differences. The DSP58 has the following.

- Wider functionality
- More flexibility in the pre-adder
- New optional negate inport
- More XOR operations
- Additional unique features

Figure 28: DSP58

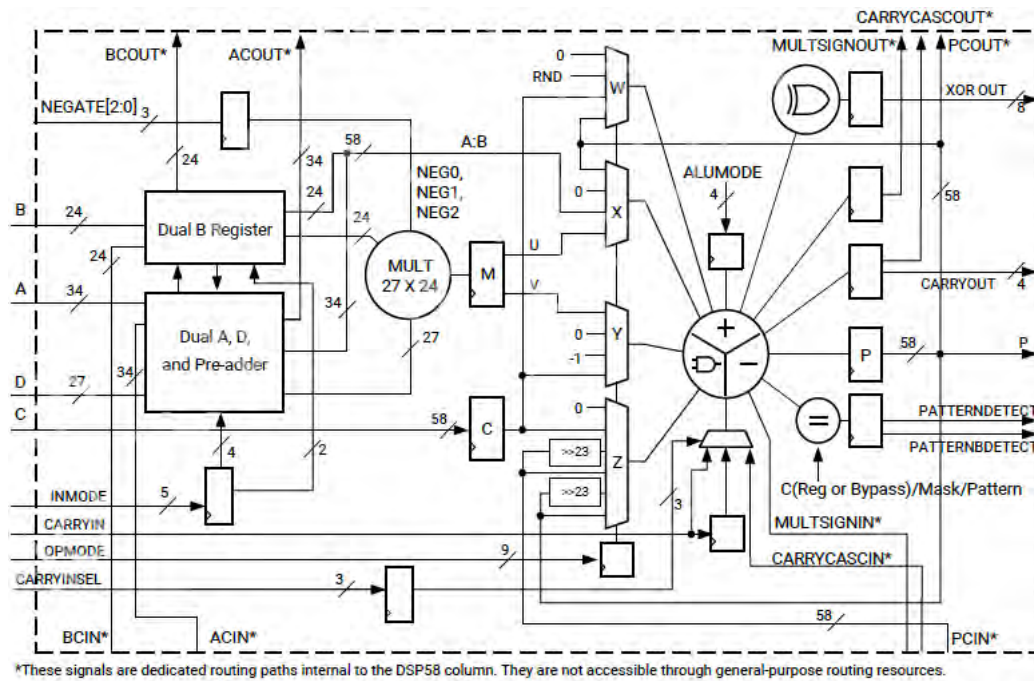

Block Parameters

The block parameters dialog box can be invoked by double-clicking the icon in your Simulink® model.

- **Basic tab:**
 - **Input Configuration:**
 - **A or ACIN input:** Specifies if the A input should be taken directly from the a port or from the cascaded acin port. The acin port can only be connected to another DSP58 block.
 - **B or BCIN input:** Specifies if the B input should be taken directly from the b port or from the cascaded bcin port. The bcin port can only be connected to another DSP58 block.
 - **DSP58 Data-Path Configuration:**
 - **SIMD Mode of Adder/Subtractor/Accumulator:** This mode can be used to implement small add-subtract functions at high speed and lower power with less logic utilization. The adder and subtractor in the adder/subtracted/logic unit can also be split into two 24-bit units or four 12-bit units.
 - **Mode of Multiplier :** This option is disabled in the current release
 - **Do not use multiplier:** When this is selected, the DSP58 block is optimized in hardware for maximum performance without using the multiplier. If an instruction using the multiplier is encountered in simulation, an error is reported.

- **Use dynamic multiplier mode:** When this is selected, it instructs the DSP58 block to use the dynamic multiplier mode. This indicates that the block is switching between $A*B$ and $A:B$ operations on the fly, and therefore needs to get the worst-case timing of the two paths.
- **Preadder Configuration:** Use the 27-bit D data input to the pre-adder or alternative input to the multiplier. The pre-adder implements $D + A$ as determined by the INMODE3 signal.
 - **PREADDINSEL Select preadder input:** Selects the input to be added with D in the pre-adder.
 - **AMULTSEL Select A multiplexer output:** Selects the input to the 27-bit A input of the multiplier. In the 7 series primitive, DSP48E1 the attribute is called USE_DPORT, but has been renamed due to new pre-adder flexibility enhancements (default AMULTSEL = A is equivalent to USE_DPORT=FALSE).
 - **BMULTSEL Select B multiplexer output:** Selects the input to the 18-bit B input of the multiplier.
 - **Enable D Port:** Automatically enabled when AD is selected.
- **Pattern Detection:**
 - **Reset p register on pattern detection:** If selected and the pattern is detected, reset the p register on the next cycle
 - **AUTO RESET PRIORITY:** When enabled by selecting the option above, select RESET (the default) or CEP (clock enabled for the P (output) register).
- **Pattern Input:**
 - **Pattern Input from c port:** When selected, the pattern used in pattern detection is read from the c port.
 - **Using Pattern Attribute (58bit hex value):** Value is used in pattern detection logic, which is best described as an equality check on the output of the adder/subtractor/logic unit.
 - **Pattern attribute:** A 58-bit value that is used in the pattern detector.
- **Mask Input:**
 - **Mask input from c port:** When selected, the mask used in pattern detection is read from the c port.
 - **Using Mask Attribute (58 bit hex value):** A 58-bit value used to mask out certain bits during pattern detection.
 - **MODE1:** Selects rounding_mode 1 (C-bar left shifted by 1).
 - **MODE2:** Selects rounding_mode 2 (C-bar left shifted by 2).
- **Wide Xor tab:** Parameters specific to the Wide Xor tab are as follows.

- **Use Wide XOR:** Use this feature to perform a 116 bit XOR function.
- **XORSIMD Select Wide XOR SIMD:** Use the XORSIMD attribute to select the width of the XOR function. Select either XOR12 (the default), XOR22, XOR24, XOR34, XOR58, or XOR116).
- **Optional Ports tab:**
 - **Input Ports:**
 - **Consolidate control port:** When selected, combines the opmode, alumode, carry_in, carry_in_sel, inmode, and negate ports into one 25-bit port. Bits 0 to 8 are the opmode, bits 9 to 12 are the alumode port, bit 13 is the carry_in port, and bits 14 to 16 are the carry_in_sel port, bits 17 to 21 are the inmode port, and bits 22 to 24 are the negate port. This option should be used when the Opmode block is used to generate a DSP58 instruction.
 - **Provide c port:** When selected, the c port is made available. Otherwise, the c port is tied to '0'.
 - **Provide global reset port:** When selected, the port rst is made available. This port is connected to all available reset ports based on the pipeline selections.
 - **Provide global enable port:** When selected, the optional en port is made available. This port is connected to all available enable ports based on the pipeline selections.
 - **Cascadable Ports:**
 - **Provide pcin port:** When selected, the pcin port is exposed. The pcin port must be connected to the pcout port of another DSP58 block.
 - **Provide carry cascade in port:** When selected, the carry cascade in port is exposed. This port can only be connected to a carry cascade out port on another DSP58 block.
 - **Provide multiplier sign cascade in port:** When selected, the multiplier sign cascade in port (multsigncascin) is exposed. This port can only be connected to a multiplier sign cascade out port of another DSP58 block.
 - **Output Ports:**
 - **Provide carryout port:** When selected, the carryout output port is made available. When the mode of operation for the adder/subtractor is set to one 58-bit adder, the carryout port is 1-bit wide. When the mode of operation is set to two 24 bit adders, the carryout port is 2 bits wide. The MSB corresponds to the second adder's carryout and the LSB corresponds to the first adder's carryout. When the mode of operation is set to four 12 bit adders, the carryout port is 4 bits wide with the bits corresponding to the addition of the 48 bit input split into four 12-bit sections.
 - **Provide pattern detect port:** When selected, the pattern detection output port is provided. When the pattern, either from the mask or the c register, is matched the pattern detection port is set to '1'.

- **Provide pattern bar detect port:** When selected, the pattern bar detection (patternbdetect) output port is provided. When the inverse of the pattern, either from the mask or the c register, is matched the pattern bar detection port is set to '1'.
- **Provide overflow port:** When selected, the overflow output port is provided. This port indicates when the operation in the DSP58 has overflowed beyond the bit P[N] where N is between 1 and 46. N is determined by the number of 1s in the mask whether set by the GUI mask field or the c port input.
- **Provide underflow port:** When selected, the underflow output port is provided. This port indicates when the operation in the DSP58 has underflowed. Underflow occurs when the number goes below $-P[N]$ where N is determined by the number of 1s in the mask whether set by the GUI mask field or the c port input.
- **Cascadable Ports:**
 - **Provide ACOUT port:** When selected, the acout output port is made available. The acout port must be connected to the acin port of another DSP58 block.
 - **Provide BCOUT port:** When selected, the bcout output port is made available. The bcout port must be connected to the bcin port of another DSP58 block.
 - **Provide PCOUT port:** when selected, the pcout output port is made available. The pcout port must be connected to the pcin port of another DSP58 block.
 - **Provide multiplier sign cascade out port:** When selected, the multiplier sign cascade out port (multsigncascout) is made available. This port can only be connected to the multiplier sign cascade in port of another DSP58 block and is used to support 96-bit accumulators/adders and subtracters which are built from two DSP58s.
 - **Provide carry cascade out port:** When selected, the carry cascade out port (carrycascout) is made available. This port can only be connected to the carry cascade in port of another 58 block.
- **Pipelining tab:**
 - **Pipeline Options:**
 - **Length of a/acin pipeline:** Specifies the length of the pipeline on input register A. A pipeline of length 0 removes the register on the input.
 - **Length of b/bCIN pipeline:** Specifies the length of the pipeline for the b input whether it is read from b or bcin.
 - **Length of acout pipeline:** Specifies the length of the pipeline between the a/acin input and the acout output port. A pipeline of length 0 removes the register from the acout pipeline length. Must be less than or equal to the length of the a/acin pipeline.
 - **Length of bcout pipeline:** Specifies the length of the pipeline between the b/bcin input and the bcout output port. A pipeline of length 0 removes the register from the bcout pipeline length. Must be less than or equal to the length of the b/bcin pipeline.

- **Pipeline c:** Indicates whether the input from the c port should be registered.
- **Pipeline p:** Indicates whether the outputs p and pcout should be registered.
- **Pipeline multiplier:** indicates whether the internal multiplier should register its output.
- **Pipeline opmode:** Indicates whether the opmode port should be registered.
- **Pipeline alumode:** Indicates whether the alumode port should be registered.
- **Pipeline carry in:** Indicates whether the carry in port should be registered.
- **Pipeline carry in select:** Indicates whether the carry in select port should be registered.
- **Pipeline preadder input register d:** Indicates to add a pipeline register to the d input.
- **Pipeline preadder output register ad:** Indicates to add a pipeline register to the ad output.
- **Pipeline INMODE register:** Indicates to add a pipeline register to the INMODE input.
- **Reset/Enable Ports tab:**
 - **Provide Reset Ports:**
 - **Reset port for a/acin:** When selected, a port rst_a is made available. This resets the pipeline register for port a when set to '1'.
 - **Reset port for b/bcin:** When selected, a port rst_b is made available. This resets the pipeline register for port b when set to '1'.
 - **Reset port for c:** When selected, a port rst_c is made available. This resets the pipeline register for port c when set to '1'.
 - **Reset port for multiplier:** when selected, a port rst_m is made available. This resets the pipeline register for the internal multiplier when set to '1'.
 - **Reset port for P:** When selected, a port rst_p is made available. This resets the output register when set to '1'.
 - **Reset port for carry in:** When selected, a port rst_carryin is made available. This resets the pipeline register for carry in when set to '1'.
 - **Reset port for alumode:** When selected, a port rst_alumode is made available. This resets the pipeline register for the alumode port when set to '1'.
 - **Reset port for controls (opmode and carry_in_sel):** When selected, a port rst_ctrl is made available. This resets the pipeline register for the opmode register (if available) and the carry_in_sel register (if available) when set to '1'.
 - **Provide Enable Ports:**

- **Enable port for first a/acin register:** When selected, an enable port ce_a1 for the first a pipeline register is made available.
- **Enable port for second a/acin register:** When selected, an enable port ce_a2 for the second a pipeline register is made available.
- **Enable port for first b/bcin register:** When selected, an enable port ce_b1 for the first b pipeline register is made available.
- **Enable port for second b/bcin register:** When selected, an enable port ce_b2 for the second b pipeline register is made available.
- **Enable port for c:** When selected, an enable port ce_c for the port C register is made available.
- **Enable port for multiplier:** When selected, an enable port ce_m for the multiplier register is made available.
- **Enable port for p:** When selected, an enable port ce_p for the port P output register is made available.
- **Enable port for carry in:** When selected, an enable port ce_carry_in for the carry in register is made available.
- **Enable port for alumode:** When selected, an enable port ce_alumode for the alumode register is made available.
- **Enable port for multiplier carry in:** When selected, an enable port mult_carry_in for the multiplier register is made available.
- **Enable port for controls (opmode and carry_in_sel):** When selected, the enable port ce_ctrl is made available. The port ce_ctrl controls the opmode and carry in select registers.
- **Enable port for d:** When selected, an enable port is added input register d.
- **Enable port for ad:** When selected, an enable port is add for the preadder output register ad.
- **Enable port for INMODE:** When selected, an enable port is added for the INMODE register.
- **Inversion Options tab :** When a checkbox is selected under this tab, the specified signal is inverted.
- **Implementation tab:**
 - **Use synthesizable model:** When selected, the DSP58 is implemented from an RTL description which might not map directly to the DSP58 hardware. This is useful if a design using the DSP58 block is targeted at device families that do not contain DSP58 hardware primitives.

- Mode of operation for the adder/subtractor:** This mode can be used to implement small add-subtract functions at high speed and lower power with less logic utilization. The adder and subtractor in the adder/subtracted/logic unit can also be split into two 24-bit fields or four 12-bit fields. This is achieved by setting the mode of operation to "Two 24-bit adders" or "Four 12-bit adders".

Other parameters used by this block are explained in the topic [Common Options in Block Parameter Dialog Boxes](#).

DSPCPLX

This block is listed in the following Xilinx Blockset libraries: Index, DSP.

The Xilinx DSPCPLX block is one of the advanced features provided by Versal™ architecture DSP, which is the optimized solution to deal with 18x18 complex multiplication followed by 58 + 58 accumulation operation.



Versal architecture DSP supports an 18-bit complex multiplier with two back-to-back DSP58s in the same tile pair together. The two DSP58s with their DSP_MODE attributes set to CINT18 form one complex arithmetic unit. The right DSP58 computes the real result P_RE and left computes the imaginary result P_IM. The following figure shows the unisim DSPCPLX primitive which is used to develop this feature.

Figure 29: Unisim DSPCPLX Primitive

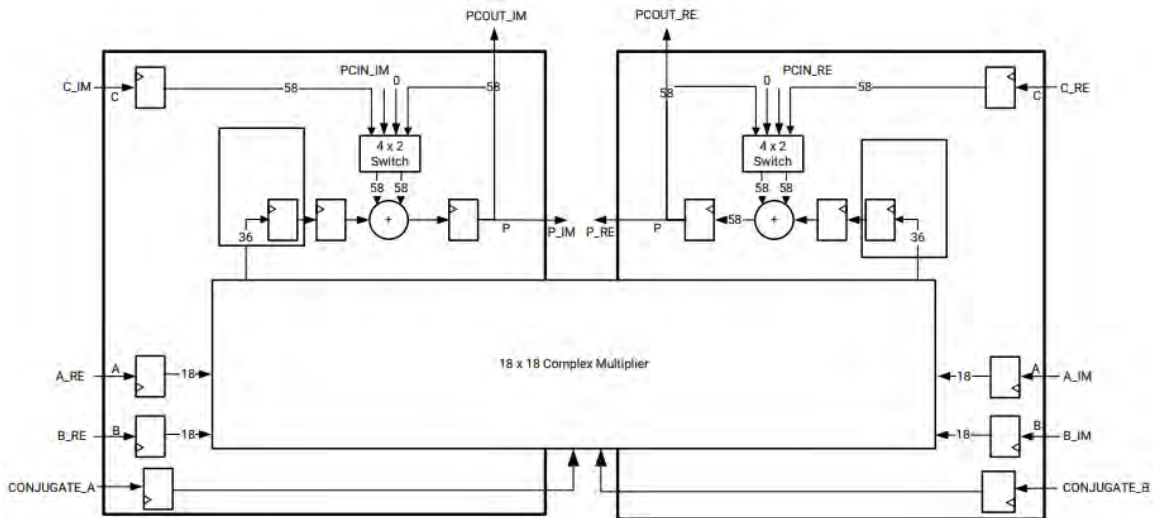

Block Parameters

The block parameters dialog box can be invoked by double-clicking the icon in your Simulink model.

- **Basic tab:** Parameters specific to the Basic tab are as follows:
 - **Input Configuration:**
 - **A or ACIN input:** Specifies if the A input should be taken directly from the `a_re`, `a_im` ports or from the cascaded `acin_re`, `acin_im` ports. The `acin_re` and `acin_im` ports can only be connected to another DSPCPLX block.
 - **B or BCIN input:** Specifies if the B input should be taken directly from the `b_re`, `b_im` ports or from the cascaded `bcin_re`, `bcin_im` ports. The `bcin_re` and `bcin_im` ports can only be connected to another DSPCPLX block.
 - **Pattern Detection on Real Output:**
 - **Reset p_re register on pattern detection:** If selected and the `pattern_re` is detected, reset the `p_re` register on the next cycle
 - **AUTO RESET PRIORITY RE:** When enabled by selecting the option above, select RESET (the default) or CEP (clock enabled for the P_RE (output) register).

- **Pattern Input RE:**
 - **Pattern Input from c_re port:** When selected, the `pattern_re` used in pattern detection on Real Output is read from the `c_re` port.
 - **Using Pattern Attribute RE (58-bit hex value):** Value is used in pattern detection logic which is best described as an equality check on the output of the adder/subtractor/logic unit.
 - **Using Pattern Attribute RE (58-bit hex value):** Enter a 58-bit value that is used in the pattern detector.
- **Mask Input RE:**
 - **Mask input from c_re port:** When selected, the `mask_re` used in pattern detection is read from the `c_re` port.
 - **Using Mask Attribute RE (58-bit hex value):** Enter a 58-bit value used to mask out certain bits during pattern detection on Real Output.
 - **MODE1:** Selects `rounding_mode 1` (`C_RE-bar` left shifted by 1).
 - **MODE2:** Selects `rounding_mode 2` (`C_RE-bar` left shifted by 2).
- **Pattern Detection on Imaginary Output:**
 - **Reset p_im register on pattern detection:** If selected and the `pattern_im` is detected, reset the `p_im` register on the next cycle.
 - **AUTO RESET PRIORITY IM:** When enabled by selecting the option above, select RESET (the default) or CEP (clock enabled for the P_IM (output) register).
- **Mask Input IM:**
 - **Mask input from c_im port:** When selected, the `mask_im` used in pattern detection on Imaginary Output is read from the `c_im` port.
 - **Using Mask Attribute RE (58-bit hex value):** Enter a 58-bit value used to mask out certain bits during pattern detection on Imaginary Output.
 - **MODE1:** Selects `rounding_mode 1` (`C_IM-bar` left shifted by 1).
 - **MODE2:** Selects `rounding_mode 2` (`C_IM-bar` left shifted by 2).
- **Optional Ports tab:** Parameters specific to the Optional Ports tab are as follows:
 - **Input Ports:**

- **Consolidate control port:** When selected, combines the `opmode`, `alumode`, `carry_in`, `carry_in_sel`, `inmode` and `conjugate` ports into one 18-bit port. Bits 0 to 8 are the `opmode`, bits 9 to 12 are the `alumode` port, bit 13 is the `carry_in` port, bits 14 to 16 are the `carry_in_sel` port, bit 17 is the `Conjugate_A` input port and bit 18 is the `Conjugate_B` port. This option should be used when the `Opmode` block is used to generate a `DSPCPLX` instruction.

Note: Enabling this option will drive both the left and right `dsp58` tiles with the same configuration.
- **Provide c port:** When selected, the `c_re` and `c_im` ports are made available. Otherwise, the `c_re` and `c_im` ports are tied to '0'.
- **Provide global reset port:** When selected, the port `rst_all` is made available. This port is connected to all available reset ports based on the pipeline selections.
- **Provide global enable port:** When selected, the optional `en_all` port is made available. This port is connected to all available enable ports based on the pipeline selections.
- **Cascadable Ports:**
 - **Provide pcin port:** When selected, the `pcin_re` and `pcin_im` ports are exposed. The `pcin_re` and `pcin_im` ports must be connected to the `pcout_re` and `pcout_im` ports of another `DSPCPLX` block respectively.
 - **Provide carry cascade in port:** When selected, the `carrycascin_re` and `carrycascin_im` ports are exposed. These ports can only be connected to a carry cascade out ports of another `DSPCPLX` block.
 - **Provide multiplier sign cascade in port:** When selected, the `multsignin_re` and `multsignin_im` ports are exposed. These ports can only be connected to a multiplier sign cascade out ports of another `DSPCPLX` block.
- **Output Ports:**
 - **Provide carryout port:** When selected, the `carryout_re` and `carryout_im` output ports are made available.
 - **Provide pattern detect port:** When selected, the `patterndetect_re` and `patterndetect_out` ports are provided. When the `pattern_re/pattern_im`, either from the `mask_re/mask_im` or the `c_re/c_im` register is matched, the respective `patterndetect_re/patterndetect_im` port is set to '1'.
 - **Provide pattern bar detect port:** When selected, the `patternbdetect_re` and `patternbdetect_im` ports are provided. When the inverse of the `pattern_re/pattern_im`, either from the `mask_re/mask_im` or the `c_re/c_im` register is matched, the `patternbdetect_re/patternbdetect_im` port is set to '1'.

- **Provide overflow port:** When selected, the `overflow_re` and `overflow_im` ports are provided. These ports indicate when the operation in the DSPCPLX has overflowed beyond the bit `P_RE[N]/P_IM[N]` where `N` is between 0 and 56. `N` is determined by the number of 1s in the `mask_re/mask_im` whether set by the GUI mask field or the `c_re/c_im` port input.
- **Provide underflow port:** When selected, the `underflow_re` and `underflow_im` ports are provided. These ports indicate when the operation in the DSPCPLX has underflowed. Underflow occurs when the number goes below `-P_RE[N]/P_IM[N]`, where `N` is determined by the number of 1s in the `mask_re/mask_im` whether set by the GUI mask field or the `c_re/c_im` port input.
- **Cascadable Ports:**
 - **Provide acout port:** When selected, the `acout_re` and `acout_im` output ports are made available. The `acout_re/acout_im` port must be connected to the `acin_re/acin_im` port of another DSPCPLX block.
 - **Provide bcout port:** When selected, the `bcout_re` and `bcout_im` output ports are made available. The `bcout_re/bcout_im` port must be connected to the `bcin_re/bcin_im` port of another DSPCPLX block.
 - **Provide pcout port:** When selected, the `pcout_re` and `pcout_im` output ports are made available. The `pcout_re/pcout_im` port must be connected to the `pcin_re/pcin_im` port of another DSPCPLX block.
 - **Provide multiplier sign cascade out port:** When selected, the `multsignout_re` and `multsignout_im` ports are made available. These ports can only be connected to the `multsignin_re` and `multsignin_im` ports of another DSPCPLX block respectively and is used to support 116-bit accumulators/adders and subtracters which are built from two DSPCPLXs.
 - **Provide carry cascade out port:** When selected, the `carrycascout_re` and `carrycascout_im` ports are made available. These ports can only be connected to the `carrycascin_re` and `carrycascin_im` ports of another DSPCPLX block respectively.
- **Pipelining tab:** Parameters specific to the Pipelining tab are as follows:
 - **Length of a_re/acin_re pipeline:** Specifies the length of the pipeline on input register `A_RE`. The pipeline of length 0 removes the register on the input.
 - **Length of a_im/acin_im pipeline:** Specifies the length of the pipeline on input register `A_IM`. The pipeline of length 0 removes the register on the input.
 - **Length of b_re/bcin_re pipeline:** Specifies the length of the pipeline for the `b_re` input and whether it is read from `b_re` or `bcin_re`.
 - **Length of b_im/bcin_im pipeline:** Specifies the length of the pipeline for the `b_im` input and whether it is read from `b_im` or `bcin_im`.

- **Length of acout_re pipeline:** Specifies the length of the pipeline between the `a_re/acin_re` input and the `acout_re` output port. The pipeline of length 0 removes the register from the `acout_re` pipeline length. Must be less than or equal to the length of the `a_re/acin_re` pipeline.
- **Length of acout_im pipeline:** Specifies the length of the pipeline between the `a_im/acin_im` input and the `acout_im` output port. The pipeline of length 0 removes the register from the `acout_im` pipeline length. Must be less than or equal to the length of the `a_im/acin_im` pipeline.
- **Length of bcout_re pipeline:** Specifies the length of the pipeline between the `b_re/bcin_re` input and the `bcout_re` output port. The pipeline of length 0 removes the register from the `bcout_re` pipeline length. Must be less than or equal to the length of the `b_re/bcin_re` pipeline.
- **Length of bcout_im pipeline:** Specifies the length of the pipeline between the `b_im/bcin_im` input and the `bcout_im` output port. The pipeline of length 0 removes the register from the `bcout_im` pipeline length. Must be less than or equal to the length of the `b_im/bcin_im` pipeline.
- **Pipeline c_re:** Indicates whether the input from the `c_re` port should be registered.
- **Pipeline c_im:** Indicates whether the input from the `c_im` port should be registered.
- **Pipeline p_re:** Indicates whether the outputs `p_re` and `pcout_re` should be registered.
- **Pipeline p_im:** Indicates whether the outputs `p_im` and `pcout_im` should be registered.
- **Pipeline multiplier_re:** Indicates whether the internal `multiplier_re` should register its output.
- **Pipeline multiplier_im:** Indicates whether the internal `multiplier_im` should register its output.
- **Pipeline opmode_re:** Indicates whether the `opmode_re` port should be registered.
- **Pipeline opmode_im:** Indicates whether the `opmode_im` port should be registered.
- **Pipeline alumode_re:** Indicates whether the `alumode_re` port should be registered.
- **Pipeline alumode_im:** Indicates whether the `alumode_im` port should be registered.
- **Pipeline carry in Re:** Indicates whether the `carryin_re` port should be registered.
- **Pipeline carry in Im:** Indicates whether the `carryin_im` port should be registered.
- **Pipeline carry in select Re:** Indicates whether the `carryinsel_re` port should be registered.
- **Pipeline carry in select Im:** Indicates whether the `carryinsel_im` port should be registered.

- **Pipeline preadder output register ad:** Indicates to add a pipeline register to the `ad` output.
- **Pipeline Conjugate register A:** Indicates to add a pipeline register to the `Conjugate_A` input.
- **Pipeline Conjugate register B:** Indicates to add a pipeline register to the `Conjugate_B` input.
- **Reset/Enable Ports tab:** Parameters specific to the Reset/Enable tab are as follows:
 - **Provide Reset Ports:**
 - **Reset port for a/acin:**

When selected, `rsta_re` and `rsta_im` ports are made available. This resets the pipeline registers for port `a_re`, `a_im` when set to '1'.
 - **Reset port for b/bcin:** When selected, `rstb_re` and `rstb_im` are made available. This resets the pipeline registers for port `b_re`, `b_im` when set to '1'.
 - **Reset port for c:** When selected, `rstc_re` and `rstc_im` are made available. This resets the pipeline registers for port `c_re`, `c_im` when set to '1'.
 - **Reset port for multiplier:** When selected, `rstm_re` and `rstm_im` are made available. This resets the pipeline registers for internal multiplier respectively when set to '1'.
 - **Reset port for P:** When selected, `rstp_re` and `rstp_im` are made available. This resets the output `p_re` and `p_im` registers when set to '1'.
 - **Reset port for carry in:** When selected, `rstallcarryin_re` and `rstallcarryin_im` are made available. This resets the pipeline registers for `carryin_re` and `carryin_im` port when set to '1'.
 - **Reset port for alumode:** When selected, `rstalumode_re` and `rstalumode_im` are made available. This resets the pipeline register for the `alumode_re` and `alumode_im` port when set to '1'.
 - **Reset port for controls (opmode and carry_in_sel):** When selected, a port `rstctrl_re` and `rstctrl_im` are made available. This resets the pipeline register for the `opmode_re/opmode_im` register (if available) and the `carryinsel_re/carryinsel_im` register (if available) when set to '1'.
 - **Reset port for ad:** When selected, port `rstad` is made available. This resets the pipeline ad register for ports when set to '1'.
 - **Reset port for Conjugate_a:** When selected, port `rstconjugate_a` is made available. This resets the pipeline register for the `Conjugate_a` port when set to '1'.
 - **Reset port for Conjugate_b:** When selected, port `rstconjugate_b` is made available. This resets the pipeline register for the `Conjugate_b` port when set to '1'.

- **Provide Enable Ports:**
 - **Enable port for first a/acin register:** When selected, enable ports `cea1_re` and `cea1_im` for the first `a_re` and `a_im` pipeline register are made available.
 - **Enable port for second a/acin register:** When selected, enable ports `cea2_re` and `cea2_im` for the second `a_re` and `a_im` pipeline registers are made available.
 - **Enable port for first b/bcin register:** When selected, enable ports `ceb1_re` and `ceb1_im` for the first `b_re` and `b_im` pipeline registers are made available.
 - **Enable port for second b/bcin register:** When selected, enable ports `ceb2_re` and `ceb2_im` for the second `b_re` and `b_im` pipeline registers are made available.
 - **Enable port for c:** When selected, enable ports `cec_re` and `cec_im` for the port `C_re` and `C_im` registers are made available.
 - **Enable port for multiplier:** When selected, enable ports `cem_re` and `cem_im` for the Real and Imaginary multiplier registers are made available.
 - **Enable port for p:** When selected, enable ports `cep_re` and `cep_im` for the port `P_re` and `P_im` output registers are made available.
 - **Enable port for carry in:** When selected, enable ports `cecarryin_re` and `cecarryin_im` for the Real and Imaginary carry in registers are made available.
 - **Enable port for alumode:** When selected, enable ports `cealumode_re` and `cealumode_im` for the Real and Imaginary alumode registers are made available.
 - **Enable port for controls (opmode and carry_in_sel):** When selected, enable ports `cectrl_re` and `cectrl_im` are made available. The ports `cectrl_re` and `cectrl_im` controls the Real and Imaginary opmode and carry in select registers.
 - **Enable port for ad:** When selected, an `enable` port is created for the preadder output register `ad`.
 - **Enable port for Conjugate_a:** When selected, an enable port `conjugate_a` is added for the `Conjugate_A` register.
 - **Enable port for Conjugate_b:** When selected, an enable port `conjugate_b` is added for the `Conjugate_B` register.
- **Inversion Options tab:** When the checkbox is selected on this tab, the specified signal is inverted.
- **Implementation tab:** Parameters specific to the Implementation tab are as follows.
 - **Use synthesizable model:** When selected, the DSPCPLX is implemented from an RTL description which might not map directly to the DSP58 hardware. This is useful if a design using the DSPCPLX block is targeted at device families that do not contain DSP58 hardware primitives.

Other parameters used by this block are explained in the topic [Common Options in Block Parameter Dialog Boxes](#).

Dual Port RAM

This block is listed in the following Xilinx® Blockset libraries: Control Logic, Memory, Floating-Point, and Index.

The Xilinx Dual Port RAM block implements a random access memory (RAM). Dual ports enable simultaneous access to the memory space at different sample rates using multiple data widths.



Block Interface

The block has two independent sets of ports for simultaneous reading and writing. Independent address, data, and write enable ports allow shared access to a single memory space. By default, each port set has one output port and three input ports for address, input data, and write enable. Optionally, you can also add a port enable and synchronous reset signal to each input port set.

A dual-port RAM can be implemented using either distributed memory, block RAM, or UltraRAM resources in the FPGA.

Form Factors

The Dual Port RAM block also supports various Form Factors (FF). Form factor is defined as:

$$FF = W_B / W_A$$

where W_B is data width of Port B and W_A is Data Width of Port A.

The Depth of port B (D_B) is inferred from the specified form factor as follows:

$$D_B = D_A / FF$$

The data input ports on Port A and B can have different arithmetic type and binary point position for a form factor of 1. For form factors greater than 1, the data input ports on Port A and Port B should have an unsigned arithmetic type with binary point at 0. The output ports, labeled A and B, have the same types as the corresponding input data ports.

The location in the memory block can be accessed for reading or writing by providing the valid address on each individual address port. A valid address is an unsigned integer from 0 to $d-1$, where d denotes the RAM depth (number of words in the RAM) for the particular port. An attempt to read past the end of the memory is caught as an error in simulation. When the dual-port RAM is implemented in distributed memory or block RAM, the initial RAM contents can be specified through a block parameter. Each write enable port must be a boolean value. When the WE port is 1, the value on the data input is written to the location indicated by the address line.

Write Mode

When the Dual Port RAM block is implemented in block RAM, you can set the write mode for the block in the block parameters dialog box.

The output during a write operation depends on the write mode. When the WE is 0, the output port has the value at the location specified by the address line. During a write operation (WE asserted), the data presented on the input data port is stored in memory at the location selected by the port's address input. During a write cycle, you can configure the behavior of each data output port A and B to one of the following choices:

- **Read after write**
- **Read before write**
- **No read on write**

The write modes can be described with the help of the figure below. In the figure, the memory has been set to an initial value of 5 and the address bit is specified as 4. When using **No read on write** mode, the output is unaffected by the address line and the output is the same as the last output when the WE was 0. For the other two modes, the output is obtained from the location specified by the address line, and hence is the value of the location being written to. This means that the output can be the old value which corresponds to **Read after write**.

Figure 30: Write Mode Output

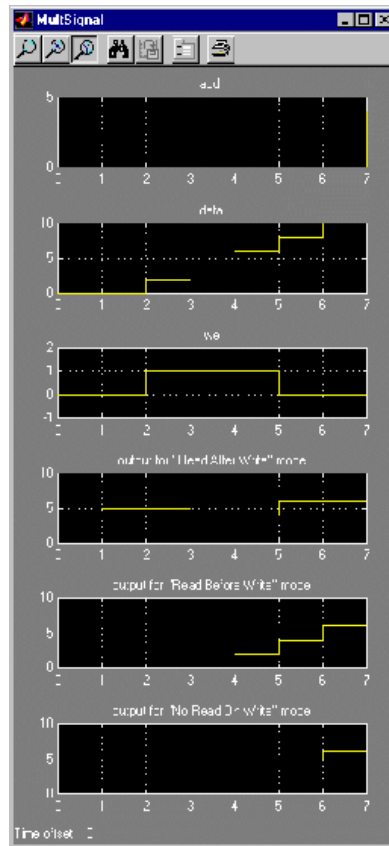

Collision Behavior

The result of simultaneous access to both ports is described below:

Read-Read Collisions

If both ports read simultaneously from the same memory cell, the read operation is successful.

Write-Write Collisions

If both ports try to write simultaneously to the same memory cell, both outputs are marked as invalid (nan).

Write-Read Collisions

This collision occurs when one port writes and the other reads from the same memory cell. While the memory contents are not corrupted, the validity of the output data on the read port depends on the Write Mode of the write port.

- If the write port is in **Read before write** mode, the other port can reliably read the old memory contents.

- If the write port is in **Read after write** or **No read on write**, data on the output of the read port is invalid (nan).

You can set the Write Mode of each port using the Advanced tab of the block parameters dialog box.

Block Parameters

The block parameters dialog box can be invoked by double-clicking the icon in your Simulink model.

- **Basic tab:** Parameters specific to the Basic tab are as follows.
 - **Depth:** Specifies the number of words in the memory for Port A, which must be a positive integer. The Port B depth is inferred from the form factor specified by the input data widths.
 - **Initial value vector:** For distributed memory or block RAM, specifies the initial memory contents. The size and precision of the elements of the initial value vector are based on the data format specified for Port A. When the vector is longer than the RAM, the vector's trailing elements are discarded. When the RAM is longer than the vector, the RAM's trailing words are set to zero. The initial value vector is saturated and rounded according to the precision specified on the data port A of RAM.

Note: UltraRAM memory is initialized to all 0's during power up or device reset. If implemented in UltraRAM, the Single Port RAM block cannot be initialized to user defined values.

- **Memory Type:** Option to select whether the dual port RAM will be implemented in **Distributed memory**, **Block RAM**, or **UltraRAM**. The distributed dual port RAM is always set to use port A in Read Before Write mode and port B in read-only mode.

Depending on your selection for **Memory Type**, the dual-port RAM will be inferred or implemented in this way when the design is compiled:

- If the block will be implemented in **Distributed memory**, the Distributed Memory Generator v8.0 LogiCORE IP will be inferred or implemented when the design is compiled. This LogiCORE IP is described in the *Distributed Memory Generator LogiCORE IP Product Guide* ([PG063](#)).
- If the block will be implemented in block RAM or UltraRAM, the XPM_MEMORY_TDPRAM (True Dual Port RAM) macro will be inferred or implemented when the design is compiled. For information on the XPM_MEMORY_TDPRAM Xilinx Parameterized Macro (XPM), refer to *UltraScale Architecture Libraries Guide* ([UG974](#)).
- **Initial value for port A output Register:** Specifies the initial value for port A output register. The initial value is saturated and rounded according to the precision specified on the data port A of RAM.

- **Initial value for port B output register:** Specifies the initial value for port B output register. The initial value is saturated and rounded according to the precision specified on the data port B of RAM.
- **Provide synchronous reset port for port A output register:** When selected, allows access to the reset port available on the port A output register of the block RAM or UltraRAM. The reset port is available only when the latency of the Block RAM or UltraRAM is greater than or equal to 1.
- **Provide synchronous reset port for port B output register:** When selected, allows access to the reset port available on the port B output register of the Block RAM or UltraRAM. The reset port is available only when the latency of the Block RAM or UltraRAM is greater than or equal to 1.
- **Provide enable port for port A:** When selected, allows access to the enable port for port A. The enable port is available only when the latency of the block is greater than or equal to 1.
- **Provide enable port for port B:** When selected, allows access to the enable port for port B. The enable port is available only when the latency of the block is greater than or equal to 1.
- **Advanced tab:** Parameters specific to the Advanced tab are as follows.
 - **Write Modes:**
 - **Port A or Port B:** When the Dual Port RAM block is implemented in block RAM, specifies memory behavior for port A or port B when WE is asserted. Supported modes are: **Read after write**, **Read before write**, and **No read on write**. **Read after write** indicates the output value reflects the state of the memory after the write operation. **Read before write** indicates the output value reflects the state of the memory before the write operation. **No read on write** indicates that the output value remains unchanged irrespective of change of address or state of the memory. There are device specific restrictions on the applicability of these modes. Also refer to the Write Mode topic above for more information.

Other parameters used by this block are explained in the topic [Common Options in Block Parameter Dialog Boxes](#).

LogiCORE and XPM Documentation

[LogiCORE IP Distributed Memory Generator v8.0](#) (Distributed Memory)

[UltraScale Architecture Libraries Guide](#) - XPM_MEMORY_TDPRAM Macro (UltraRAM)

Exponential

This block is listed in the following Xilinx® Blockset libraries: Floating-Point, Math, and Index.

This Xilinx Exponential block performs the exponential operation on the input. Currently, only the floating-point data type is supported.

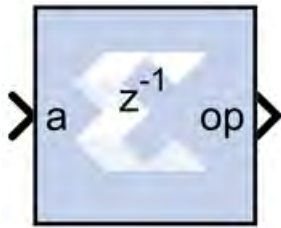

Block Parameters

The block parameters dialog box can be invoked by double-clicking the icon in your Simulink® model.

- **Basic tab:** Parameters specific to the Basic tab are as follows.
 - **AXI Interface:**
 - **Flow Control:**
 - **Blocking:** Selects “Blocking” mode. In this mode, the lack of data on one input channel does block the execution of an operation if data is received on another input channel.
 - **NonBlocking:** Selects “Non-Blocking” mode. In this mode, the lack of data on one input channel does not block the execution of an operation if data is received on another input channel.
 - **Optimize Goal:** When NonBlocking mode is selected, the following optimization options are activated.
 - **Resources:** Block is configured for minimum resources.
 - **Performance:** Block is configured for maximum performance.
 - **Block Memory Usage:**
 - **BMG Usage:**
 - **No Usage:** Do not use Block Memory.
 - **Full Usage:** Make full use of Block Memory.
 - **Latency Specification:**
 - **Latency:** This defines the number of sample periods by which the block's output is delayed.
- **Optional Ports tab:** Parameters specific to the Optional Ports tab are as follows.

- **Input Channel Ports:**
 - **Has TLAST:** Adds a tlast port to the input channel.
 - **Has TUSER:** Adds a tuser port to the input channel.
- **Control Options:**
 - **Provide enable port:** Add an enable port to the block interface.
 - **Has Result TREADY:** Add a TREADY port to the result channel.
- **Exception Signals:**
 - **UNDERFLOW:** Add an output port that serves as an underflow flag.
 - **OVERFLOW:** Add an output port that serves as an overflow flag.

Other parameters used by this block are explained in the topic [Common Options in Block Parameter Dialog Boxes](#).

LogiCORE Documentation

[LogiCORE IP Floating-Point Operator v7.1](#)

Expression

This block is listed in the following Xilinx® Blockset libraries: Basic Elements, Control Logic, Math, and Index.

The Xilinx Expression block performs a bitwise logical expression.

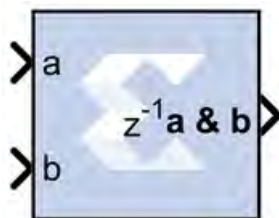

The expression is specified with operators described in the table below. The number of input ports is inferred from the expression. The input port labels are identified from the expression, and the block is subsequently labeled accordingly. For example, the expression: $\sim((a1 \mid a2) \& (b1 \wedge b2))$ results in the following block with 4 input ports labeled 'a1', 'a2', 'b1', and 'b2'.



The expression is parsed and an equivalent statement is written in VHDL (or Verilog). Shown below, in decreasing order of precedence, are the operators that can be used in the Expression block.

Operator	Symbol
Precedence	()
NOT	~
AND	&
OR	
XOR	^

Block Parameters

The block parameters dialog box can be invoked by double-clicking the icon in your Simulink® model.

- **Basic tab:** Parameters specific to the Basic tab are as follows.
 - **Expression:** Bitwise logical expression.
 - **Align Binary Point:** Specifies that the block must align binary points automatically. If not selected, all inputs must have the same binary point position.

Other parameters used by this block are explained in the topic [Common Options in Block Parameter Dialog Boxes](#).

Fast Fourier Transform 9.1

This block is listed in the following Xilinx® Blockset libraries: AXI4, DSP, Floating-Point, and Index.

The Xilinx Fast Fourier Transform block implements the Cooley-Tukey FFT algorithm, a computationally efficient method for calculating the Discrete Fourier Transform (DFT). In addition, the block provides an AXI4-Stream-compliant interface.

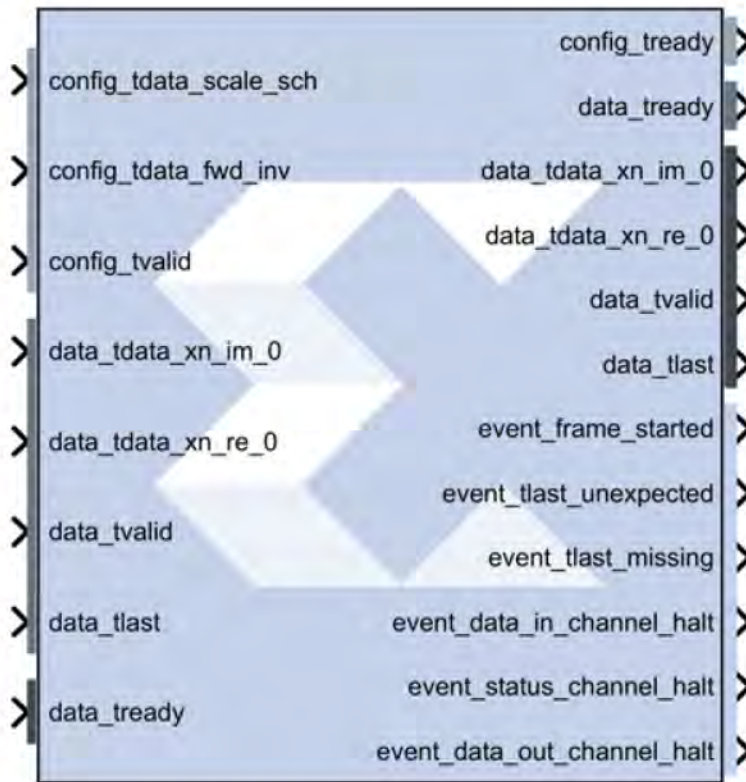

The FFT computes an N-point forward DFT or inverse DFT (IDFT) where, $N = 2^m$, $m = 3 - 16$. For fixed-point inputs, the input data is a vector of N complex values represented as dual b_x -bit two's complement numbers, that is, b_x bits for each of the real and imaginary components of the data sample, where b_x is in the range 8 to 34 bit, inclusive. Similarly, the phase factors b_w can be 8 to 34 bits wide.

For single-precision floating-point inputs, the input data is a vector of N complex values represented as dual 32-bit floating-point numbers with the phase factors represented as 24- or 25-bit fixed-point numbers.

Theory of Operation

The FFT is a computationally efficient algorithm for computing a Discrete Fourier Transform (DFT) of sample sizes that are a positive integer power of 2. The DFT of a sequence is defined as:

$$X(k) = \sum_{n=0}^{N-1} x(n) e^{-jnk2/N} \quad k=0, \dots, N-1$$

where N is the transform length and j is the square root of -1. The inverse DFT (IDFT) is:

$$x(n) = \frac{1}{N} \sum_{k=0}^{N-1} X(k) e^{jnk2/N} \quad n=0, \dots, N-1$$

AXI Ports that are Unique to this Block

This Sysgen Generator block exposes the AXI CONFIG channel as a group of separate ports based on sub-field names. The sub-field ports are described as follows:

Configuration Channel Input Signals:

config_tdata_scale_sch	A sub-field port that represents the Scaling Schedule field in the Configuration Channel vector. Refer to the document LogiCORE IP Fast Fourier Transform v9.1 for an explanation of the bits in this field.
config_tdata_fwd_inv	A sub-field port that represents the Forward Inverse field in the Configuration Channel vector. Refer to the document LogiCORE IP Fast Fourier Transform v9.1 for an explanation of the bits in this field.
config_tdata_nfft	A sub-field port that represents the Transform Size (NFFT) field in the Configuration Channel vector. Refer to the document LogiCORE IP Fast Fourier Transform v9.1 for an explanation of the bits in this field.
config_tdata_cp_len	A sub-field port that represents the Cyclic Prefix Length (CP_LEN) field in the Configuration Channel vector. Refer to the document LogiCORE IP Fast Fourier Transform v9.1 for an explanation of the bits in this field.

This System Generator block exposes the AXI DATA channel as separate ports based on the real and imaginary sub-field names. The sub-field ports are described as follows:

DATA Channel Input Signals:

data_tdata_xn_im	Represents the imaginary component of the Data Channel. The signal driving xn_im can be a signed data type of width S with binary point at S-1, where S is a value between 8 and 34, inclusive. eg: Fix_8_7, Fix_34_33. Both xn_re and xn_im signals must have the same data type. Refer to the document LogiCORE IP Fast Fourier Transform v9.1 for an explanation of the bits in this field.
data_tdata_xn_re	Represents the real component of the Data Channel. The signal driving xn_re can be a signed data type of width S with binary point at S-1, where S is a value between 8 and 34, inclusive. eg: Fix_8_7, Fix_34_33. Both xn_re and xn_im signals must have the same data type. Refer to the document LogiCORE IP Fast Fourier Transform v9.1 for an explanation of the bits in this field.

Block Parameters

The block parameters dialog box can be invoked by double-clicking the icon in your Simulink® model.

- **Basic tab:** Parameters specific to the Basic tab are as follows.

- **Transform Length:**
 - **Transform_length:** One of $N = 2^{(3..16)} = 8 - 65536$.
- **Architecture Configuration:**
 - **Target Clock Frequency(MHz):** Enter the target clock frequency.
 - **Target Data Throughput(MSPS):** Enter the target throughput.
 - **Architecture Choice:** Choose one of the following.
 - `automatically_select`
 - `pipelined_streaming_io`
 - `radix_4_burst_io`
 - `radix_2_burst_io`
 - `radix_2_lite_burst_io`
- **Transform Length Options:**
 - **Run Time Configurable Transform Length:** The transform length can be set through the nfft port if this option is selected. Valid settings and the corresponding transform sizes are provided in the section titled Transform Size in the associated document [LogiCORE IP Fast Fourier Transform v9.1](#) for an explanation of the bits in this field.
- **Advanced tab:** Parameters specific to the Advanced tab are as follows.
 - **Precision Options:**
 - **Phase Factor Width:** Choose a value between 8 and 34, inclusive to be used as bit widths for phase factors.
 - **Scaling Options:** Select between **Unscaled**, **Scaled**, and **Block Floating Point** output data types.
 - **Rounding Modes:**
 - **Truncation:** To be applied at the output of each rank.
 - **Convergent Rounding:** To be applied at the output of each rank.
- **Control Signals:**
 - **ACLKEN:** Enables the clock enable (aclken) pin on the core. All registers in the core are enabled by this control signal.
 - **ARESETn:** Active-low synchronous clear input that always takes priority over ACLKEN. A minimum ARESETn active pulse of two cycles is required, since the signal is internally registered for performance. A pulse of one cycle resets the core, but the response to the pulse is not in the cycle immediately following.

- **Output Ordering:**

- **Cyclic Prefix Insertion:**

Cyclic prefix insertion takes a section of the output of the FFT and prefixes it to the beginning of the transform. The resultant output data consists of the cyclic prefix (a copy of the end of the output data) followed by the complete output data, all in natural order. Cyclic prefix insertion is only available when output ordering is Natural Order.

When cyclic prefix insertion is used, the length of the cyclic prefix can be set frame-by-frame without interrupting frame processing. The cyclic prefix length can be any number of samples from zero to one less than the point size. The cyclic prefix length is set by the CP_LEN field in the Configuration channel. For example, when $N = 1024$, the cyclic prefix length can be from 0 to 1023 samples, and a CP_LEN value of 0010010110 produces a cyclic prefix consisting of the last 150 samples of the output data.

- **Output ordering:** Choose between **Bit/Digit Reversed Order** or **Natural Order** output.
 - **Throttle Schemes:** Select the tradeoff between performance and data timing requirements.
 - **Real Time:** This mode typically gives a smaller and faster design, but has strict constraints on when data must be provided and consumed.
 - **Non Real Time:** This mode has no such constraints, but the design might be larger and slower.
 - **Optional Output Fields:**
 - **XK_INDEX:** The XK_INDEX field (if present in the Data Output channel) gives the sample number of the XK_RE/XK_IM data being presented at the same time. In the case of natural order outputs, XK_INDEX increments from 0 to (point size) -1. When bit reversed outputs are used, XK_INDEX covers the same range of numbers, but in a bit (or digit) reversed manner.

- **OVFLO:**

The Overflow (OVFLO) field in the Data Output and Status channels is only available when the Scaled arithmetic is used. OVFLO is driven High during unloading if any point in the data frame overflowed.

For a multichannel core, there is a separate OVFLO field for each channel. When an overflow occurs in the core, the data is wrapped rather than saturated, resulting in the transformed data becoming unusable for most applications

- **Block Icon Display:**
 - **Display shortened port names:** On by default. When unchecked, `data_tvalid`, for example, becomes `m_axis_data_tvalid`.
- **Implementation tab:** Parameters specific to the Implementation tab are as follows.

- **Memory Options:**
 - **Data:** Option to choose between **Block RAM** and **Distributed RAM**. This option is available only for sample points 8 through 1024. This option is not available for Pipelined Streaming I/O implementation.
 - **Phase Factors:** Choose between **Block RAM** and **Distributed RAM**. This option is available only for sample points 8 till 1024. This option is not available for Pipelined Streaming I/O implementation.
 - **Number Of Stages Using Block RAM:** Store data and phase factor in **Block RAM** and partially in **Distributed RAM**. This option is available only for the Pipelined Streaming I/O implementation.
 - **Reorder Buffer:** Choose between **Block RAM** and **Distributed RAM** up to 1024 points transform size.
 - **Hybrid Memories:** Click check box to **Optimize Block RAM Count Using Hybrid Memories**.
- **Optimize Options:**
 - **Complex Multipliers:** Choose one of the following.
 - Use CLB logic
 - Use 3-multiplier structure (resource optimization)
 - Use 4-multiplier structure (performance optimization)
 - **Butterfly Arithmetic:** Choose one of the following:
 - Use CLB logic
 - Use XTremeDSP Slices

Other parameters used by this block are explained in the topic [Common Options in Block Parameter Dialog Boxes](#).

Block Timing

To better understand the FFT blocks control behavior and timing, please consult the core data sheet.

LogiCORE Documentation

[LogiCORE IP Fast Fourier Transform v9.1](#)

[LogiCORE IP Floating-Point Operator v7.1](#)

FDATool

This block is listed in the following Xilinx® Blockset libraries: DSP, Tools, and Index.

The Xilinx FDATool block provides an interface to the FDATool software available as part of the MATLAB® Signal Processing Toolbox.



The block does not function properly and should not be used if the Signal Processing Toolbox is not installed. This block provides a means of defining an FDATool object and storing it as part of a System Generator model. FDATool provides a powerful means for defining digital filters with a graphical user interface.

Example of Use

Copy an FDATool block into a Subsystem where you would like to define a filter. Double-clicking the block icon opens up an FDATool session and graphical user interface. The filter is stored in an data structure internal to the FDATool interface block, and the coefficients can be extracted using MATLAB® helper functions provided as part of System Generator. The function call `xlfa_numerator('FDATool')` returns the numerator of the transfer function (e.g., the impulse response of a finite impulse response filter) of the FDATool block named 'FDATool'. Similarly, the helper function `xlfa_denominator('FDATool')` retrieves the denominator for a non-FIR filter.

A typical use of the FDATool block is as a companion to an FIR filter block, where the Coefficients field of the filter block is set to `xlfa_numerator('FDATool')`. An example is shown in the following diagram:

Figure 31: FDATool Example

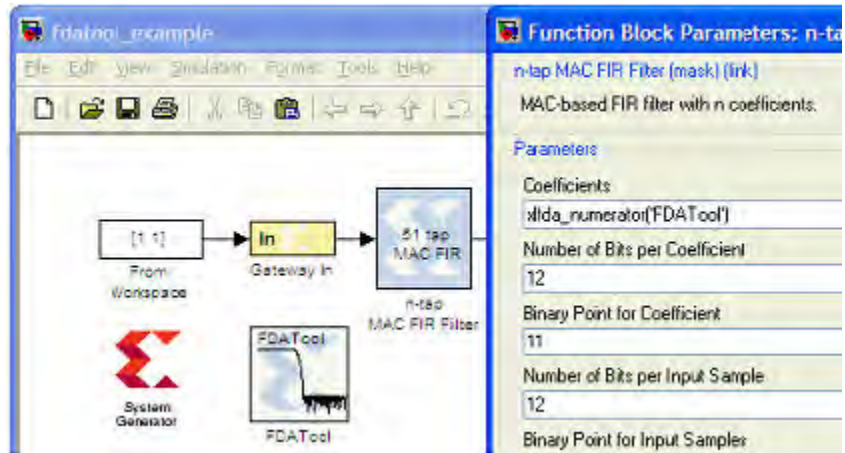

Note that `xlfda_numerator()` can equally well be used to initialize a memory block or a 'coefficient' variable for a masked Subsystem containing an FIR filter.

This block does not use any hardware resources.

FDA Tool Interface

Double-clicking the icon in your Simulink model opens up an FDATool session and its graphical user interface. Upon closing the FDATool session, the underlying FDATool object is stored in the UserData parameter of the Xilinx FDATool block. Use the `xlfda_numerator()` helper function and `get_param()` to extract information from the object as desired.

FFT

This block is listed in the following Xilinx® Blockset libraries: DSP, Floating-Point, and Index.

The Xilinx FFT (Fast Fourier Transform) block takes a block of time domain waveform data and computes the frequency of the sinusoid signals that make up the waveform.

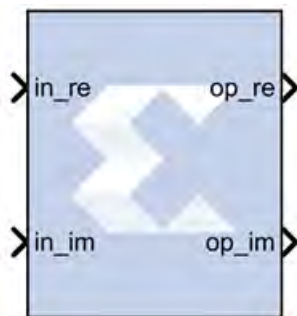

FFT is a fast implementation of the discrete Fourier transform. The data of the time domain signal is sampled at discrete intervals. The sampling frequency is twice the maximum frequency that can be resolved by the FFT, based on the Nyquist theorem. If a signal is sampled at 1 kHz, the highest frequency that can be resolved by the FFT is 500 Hz.

$$f_s = f_{\max}/2$$

where f_{\max} = maximum resolvable frequency and f_s = sampling frequency.

The duration of the data sample is inversely proportional to the frequency resolution of the FFT. The longer the sample duration, the higher the number of data points, and the finer the frequency resolution. If a signal sampled at f_s for twice the duration, the difference between successive frequency d_f is halved, resulting in an FFT with finer frequency resolution.

$$d_f = 1/T$$

where d_f = frequency resolution of the FFT, and T = total sampling time.

The number of samples taken over time T is N , so sampling frequency is N/T samples/sec.

Description

FFT is a computationally efficient implementation of the Discrete Fourier Transform (DFT). A DFT is a collection of data points detailing the correlation between the time domain signal and sinusoids at discrete frequencies.

The DFT is defined by the following equation:

$$X(k) = \sum_{n=0}^{N-1} x[n] e^{-j \frac{2\pi}{N} nk} \text{ for } k=0,1,2, \dots, N-1$$

where N is the transform length, k is used to denote the frequency domain ordinal, and n is used to represent the time-domain ordinal.

The FFT block is ideal for implementing simple Fourier transforms. If your FFT implementation will use more complicated transform features such as an AXI4-Stream-compliant interface, a real time throttle scheme, Radix-4 Burst I/O, or Radix-2 Lite Burst I/O, use the Xilinx [Fast Fourier Transform 9.1](#) block in your design instead of the FFT block.

In the Vivado® design flow, the FFT block is inferred as "LogiCORE IP Fast Fourier Transform v9.1" for code generation. Refer to the document [LogiCORE IP Fast Fourier Transform v9.1](#) for details on this LogicCore IP.

Block Parameters

The block parameters dialog box can be invoked by double-clicking the icon in your Simulink® model.

Parameters specific to the Xilinx FFT block are as follows.

- **Transform Length:** Select the desired point size ranging from 8 to 65536.
- **Scale Result by FFT length:** If selected, data is scaled between FFT stages using a scaling schedule determined by the **Transform Length** setting. If not selected, data is unscaled, and all integer bit growth is carried to the output.
- **Natural Order:** If selected, the output of the FFT block will be ordered in natural order. If not selected, the output of the FFT block will be ordered in bit/digit reversed order.
- **Optimize for:** Directs the block to be optimized for either speed (**Performance**) or area (**Resources**) in the generated hardware.

Note: If **Resources** is selected and the input sample period is 8 times slower than the system sample period, the block implements Radix-2 Burst I/O architecture. Otherwise, Pipeline Streaming I/O architecture will be used.

- **Optional Port:**
 - **Provide start frame port:** Adds `start_frame_in` and `start_frame_out` ports to the block. The signals on these ports can be used to synchronize frames at the input and output of the FFT block. See [Adding Start Frame Ports to Synchronize Frames](#) for a description of the operation of these two ports.

Context Based Pipeline vs. Radix Implementation

Pipelined Streaming I/O and Radix-2 Burst I/O architectures are supported by the FFT block. Radix-4 Burst I/O architecture is implemented when you select **Optimize for: Resources** block parameter and the sample rate of the inputs is 8 times slower than the system rate. In all other configurations Pipelined Streaming I/O architecture is implemented by default.

Input Data Type Support

The FFT block accepts inputs of varying bit widths with changeable binary point location, such as `Fix_16_0` or `Fix_30_10`, etc. in unscaled block configuration. For the scaled configuration, the input is supported in the same format as the [Fast Fourier Transform 9.1](#) block. The [Fast Fourier Transform 9.1](#) block accepts input values only in the normalized form in the format of `Fix_x_[x-1]` (for example, `Fix_16_15`), so the inputs are 2's complement with a single sign/integer bit.

Latency Value Displayed on the Block

The latency value depends on parameters selected by the user, and the corresponding latency value is displayed on the FFT block icon in the Simulink model.

Automatic Fixed Point and Floating Point Support

Signed fixed point and floating point data types are supported.

For floating point input, either scaled or unscaled data can be selected in the FFT block parameters. In the [Fast Fourier Transform 9.1](#) block, the floating point data type is accepted only when the scaled configuration is selected by the user.

Handling Overflow for Scaled Configuration

The FFT block uses a conservative schedule to avoid overflow scenarios. This schedule sets the scaling value for the corresponding FFT stages in a way that makes sure no overflow occurs.

Adding Start Frame Ports to Synchronize Frames

Selecting **Provide start frame port** in the FFT block properties dialog box adds `start_frame_in` and `start_frame_out` ports at the input and output of the FFT block. These ports are used to synchronize frames at the input and output of the FFT block.

Figure 32: Adding Start Frame Ports

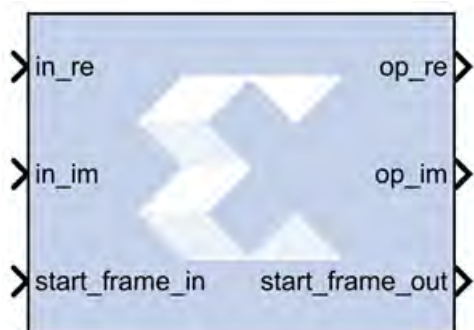

You must provide a valid input at the `start_frame_in` port. When the `start_frame_in` signal is asserted, an impulse is generated at the start of every frame to signal the FFT block to start processing the frame. The frame size is the **Transform Length** entered in the block parameters dialog box.

The `start_frame_out` port provides the information as to when the output frames start. An impulse at the start of every frame on the output side helps in tracking the block behavior.

The FFT block has a frame alignment requirement and these ports help the block operate in accordance with this requirement.

The figure below shows that as soon as the output is processed by the FFT block the `start_frame_out` signal becomes High (1).

Figure 33: Output

re_data_out	000280	000000	000280
img_data_out	000280	000000	000280
start_frame_out	1	0	1

The following apply to the **Provide start frame port** option and the start frame ports added to the FFT block when the option is enabled:

- The **Provide start frame port** option selection is valid only for Pipelined Streaming I/O architecture. See [Context Based Pipeline vs. Radix Implementation](#) for a description of the conditions under which Pipelined Streaming I/O architecture is implemented.
- The option is valid only for input of type fixed point.
- Verilog is supported for netlist generation currently, when the **Provide start frame port** option is selected.

Note: The first sample input to the FFT block may be ignored and users are advised to drive the input data accordingly.

LogiCORE Documentation

[LogiCORE IP Fast Fourier Transform v9.1](#)

FIFO

This block is listed in the following Xilinx® Blockset libraries: Control Logic, Floating-Point, Memory, and Index.

The Xilinx FIFO block implements an FIFO memory queue.



Values presented at the module's data-input port are written to the next available empty memory location when the write-enable input is one. By asserting the read-enable input port, data can be read out of the FIFO using the data output port (`dout`) in the order in which they were written. The FIFO can be implemented using block RAM, distributed RAM, SRL, or built-in FIFO.

The `full` output port is asserted to one when no unused locations remain in the module's internal memory. The `percent_full` output port indicates the percentage of the FIFO that is full, represented with user-specified precision. When the `empty` output port is asserted the FIFO is empty.

Block Parameters

The block parameters dialog box can be invoked by double-clicking the icon in your Simulink® model.

- **Basic tab:**

Parameters specific to the Basic tab are as follows.

- **FIFO Implementation:**

- **Memory Type:**

This block implements FIFOs built from block RAM, distributed RAM, shift registers, or the 7 series built-in FIFOs. Memory primitives are arranged in an optimal configuration based on the selected width and depth of the FIFO. The following table provides best-use recommendations for specific design requirements.

Table 15: Memory Type

	Independent Clocks	Common Clock	Small Buffering	Medium-Large Buffering	High Performance	Minimal Resources
7 Series, with Built-In FIFO	X	X		X	X	X
Block RAM	X	X		X	X	X
Shift Register		X	X		X	
Distributed RAM	X	X	X		X	

- **Performance Options:**

- **Standard FIFO:** FIFO will operate in Standard Mode.

- **First Word Fall Through:** FIFO will operate in First-Word Fall-Through (FWFT) mode. The First-Word Fall-Through feature provides the ability to look-ahead to the next word available from the FIFO without issuing a read operation. When data is available in the FIFO, the first word falls through the FIFO and appears automatically on the output. FWFT is useful in applications that require low-latency access to data and to applications that require throttling based on the contents of the data that are read. FWFT support is included in FIFOs created with block RAM, distributed RAM, or built-in FIFOs in 7 series devices.
- **Implementation Options:**
 - **Use Embedded Registers (when possible):** In 7 series FPGA block RAM and FIFO macros, embedded output registers are available to increase performance and add a pipeline register to the macros. This feature can be leveraged to add one additional cycle of latency to the FIFO core (DOUT bus and VALID outputs) or implement the output registers for FWFT FIFOs. The embedded registers available in 7 series FPGAs can be reset (DOUT) to a default or user programmed value for common clock built-in FIFOs. See the topic **Embedded Registers in block RAM and FIFO Macros** in the [LogiCORE IP FIFO Generator 12.0](#).
- **Depth:** Specifies the number of words that can be stored. Range 16K-4M.
- **Bits of precision to use for %full signal:** Specifies the bit width of the %full port. The binary point for this unsigned output is always at the top of the word. Thus, if for example precision is set to one, the output can take two values: 0.0 and 0.5, the latter indicating the FIFO is at least 50% full.
- **Optional Ports:**
 - **Provide reset port:** Add a reset port to the block.
 - **Reset Latency:** Creates a latency on the reset by adding registers. The default is 1.

Note: For UltraScale™ devices, after the reset gets asserted, the FIFO will remain disable for the next 20 cycles. During this 20 cycle period, all read and write operations are ignored.
 - **Provide enable port:** Add enable port to the block.
 - **Provide data count port:** Add data count port to the block. Provides the number of words in the FIFO.
 - **Provide percent full port:** Add a percent full output port to the block. Indicates the percentage of the FIFO that is full using the user-specified precision. This optional port is turned on by default for backward compatibility reasons.
 - **Provide almost empty port:** Add almost empty (ae) port to the block.
 - **Provide almost full port:** Add almost efull (af) port to the block.

Following are some general guidelines to use Reset, Write enable, Read enable for the 'built-in FIFO' Memory type:

- **7 series devices:** Without Reset port, it is required to run at least 8 clock cycles latency before asserting WE/RE signals. With Reset port, it is required to run Reset signal ON for at least three clock cycles. During this time no WE or RE signals should be asserted. To be consistent across all built-in FIFO configurations, it is recommended to give reset pulse of at least five clock cycles.

After Reset de-assertion, run at least 30 clock cycles (reset duration +30 clock cycles duration is defined as a no access zone) before asserting WE/RE signals.

- **UltraScale devices:** The built-in FIFO requires a reset pulse of at least one clock cycle.
- **Versal Devices:** Read enable (`rd_en`) and Write enable (`wr_en`) signals can be made high only when `rd_rst_busy` and `wr_rst_busy` signals are low.

Other parameters used by this block are explained in the topic [Common Options in Block Parameter Dialog Boxes](#).

LogiCORE Documentation

[LogiCORE IP FIFO Generator 12.0](#)

[LogiCORE IP Floating-Point Operator v7.1](#)

FIR Compiler 7.2

This block is listed in the following Xilinx® Blockset libraries: AXI4, DSP, and Index.

This Xilinx FIR Compiler block provides users with a way to generate highly parameterizable, area-efficient, high-performance FIR filters with an AXI4-Stream-compliant interface.

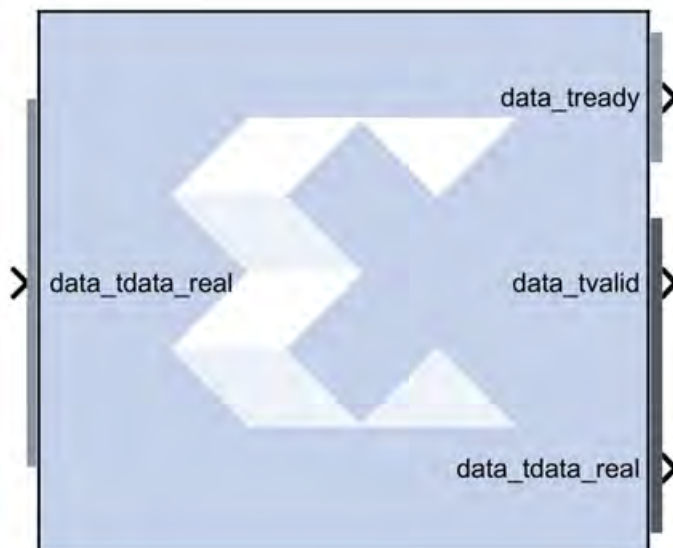

AXI Ports that are Unique to this Block

This block exposes the AXI CONFIG channel as a group of separate ports based on sub-field names. The sub-field ports are described as follows:

Configuration Channel Input Signals:

config_tdata_fsel	A sub-field port that represents the fsel field in the Configuration Channel vector. fsel is used to select the active filter set. This port is exposed when the number of coefficient sets is greater than one. Refer to the FIR Compiler V7.2 Product Guide for an explanation of the bits in this field.
-------------------	---

Block Parameters

The block parameters dialog box can be invoked by double-clicking the icon in your Simulink® model.

- **Filter Specification tab:**

Parameters specific to the Filter Specification tab are as follows.

- **Filter Coefficients:**

- **Coefficient Vector:** Specifies the coefficient vector as a single MATLAB® row vector. The number of taps is inferred from the length of the MATLAB® row vector. If multiple coefficient sets are specified, then each set is appended to the previous set in the vector. It is possible to enter these coefficients using the [FDA Tool](#) block as well.
- **Number of Coefficients Sets:** The number of sets of filter coefficients to be implemented. The value specified must divide without remainder into the number of coefficients.
- **Use Reloadable Coefficients:** Check to add the coefficient reload ports to the block. The set of data loaded into the reload channel will not take action until triggered by a re-configuration synchronization event. Refer to the [FIR Compiler V7.2 Product Guide](#) for a more detailed explanation of the RELOAD Channel interface timing. This block supports the `xlGetReloadOrder` function. See the System Generator Utility function `xlGetReloadOrder` for details.

- **Filter Specification:**

- **Filter Type:**

- **Single_Rate:** The data rate of the input and the output are the same.
- **Interpolation:** The data rate of the output is faster than the input by a factor specified by the Interpolation Rate value.
- **Decimation:** The data rate of the output is slower than the input by a factor specified in the Decimation Rate Value.
- **Hilbert:** Filter uses the Hilbert Transform.

- **Interpolated:** An interpolated FIR filter has a similar architecture to a conventional FIR filter, but with the unit delay operator replaced by $k-1$ units of delay. k is referred to as the zero-packing factor. The interpolated FIR should not be confused with an interpolation filter. Interpolated filters are single-rate systems employed to produce efficient realizations of narrow-band filters and, with some minor enhancements, wide-band filters can be accommodated. The data rate of the input and the output are the same.
- **Rate Change Type:** This field is applicable to Interpolation and Decimation filter types. Used to specify an **Integer** or **Fixed_Fractional** rate change.
- **Interpolation Rate Value:** This field is applicable to all Interpolation filter types and Decimation filter types for Fractional Rate Change implementations. The value provided in this field defines the up-sampling factor, or P for Fixed Fractional Rate (P/Q) resampling filter implementations.
- **Decimation Rate Value:** This field is applicable to the all Decimation and Interpolation filter types for Fractional Rate Change implementations. The value provided in this field defines the down-sampling factor, or Q for Fixed Fractional Rate (P/Q) resampling filter implementations.
- **Zero pack factor:** Allows you to specify the number of 0's inserted between the coefficient specified by the coefficient vector. A zero packing factor of k inserts $k-1$ 0s between the supplied coefficient values. This parameter is only active when the Filter type is set to Interpolated.
- **Channel Specification tab:** Parameters specific to the Channel Specification tab are as follows.
 - **Interleaved Channel Specification:**
 - **Channel Sequence:** Select Basic or Advanced. See the [LogiCORE IP FIR Compiler v7.2 Product Guide](#) for an explanation of the advanced channel specification feature.
 - **Number of Channels:** The number of data channels to be processed by the FIR Compiler block. The multiple channel data is passed to the core in a time-multiplexed manner. A maximum of 64 channels is supported.
 - **Sequence ID List:** A comma delimited list that specifies which channel sequences are implemented.
 - **Parallel Channel Specification:**
 - **Number of Paths:** Specifies the number of parallel data paths the filter is to process. As shown below, when more than one path is specified, the `data_tdata` input port is divided into sub-ports that represent each parallel path.

Figure 34: Number of Paths

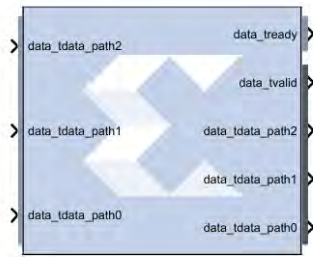

- **Hardware Oversampling Specification:**
 - **Select format:**
 - **Maximum_Possible:** Specifies that oversampling be automatically determined based on the din sample rate.
 - **Input_Sample_Period/Output_Sample_Period:** Activates the Sample period dialog box below. Enter the Sample Period specification. Selecting this option exposes the s_axis_data_tvalid port (called ND port on earlier versions of the core). With this port exposed, no input handshake abstraction and no rate-propagation takes place.
 - **Hardware Oversampling Rate:** Activates the Hardware Oversampling Rate dialog box. Enter the Hardware Oversampling Rate specification below.
 - **Hardware Oversampling Rate:** The hardware oversampling rate determines the degree of parallelism. A rate of one produces a fully parallel filter. A rate of n (resp., n+1) for an n-bit input signal produces a fully serial implementation for a non-symmetric (resp., symmetric) impulse response. Intermediate values produce implementations with intermediate levels of parallelism.
- **Implementation tab:** Parameters specific to the Implementation tab are as follows.
 - **Coefficient Options:**
 - **Coefficient Type:** Specify Signed or Unsigned.
 - **Quantization:** Specifies the quantization method to be used for quantizing the coefficients. This can be set to one of the following:
 - Integer_Coefficients
 - Quantize_Only
 - Maximize_Dynamic_Range
 - Normalize_to_Centre_Coefficient
 - **Coefficient Width:** Specifies the number of bits used to represent the coefficients.

- **Best Precision Fractional Bits:** When selected, the coefficient fractional width is automatically set to maximize the precision of the specified filter coefficients.
- **Coefficient Fractional Bits:** Specifies the binary point location in the coefficients datapath options.
- **Coefficients Structure:** Specifies the coefficient structure. Depending on the coefficient structure, optimizations are made in the core to reduce the amount of hardware required to implement a particular filter configuration. The selected structure can be any of the following.
 - Inferred
 - Non-Symmetric
 - Symmetric
 - Negative_Symmetric
 - Half_Band
 - Hilbert

The vector of coefficients specified must match the structure specified unless Inferred from coefficients is selected in which case the structure is determined automatically from these coefficients.
- **Datapath Options:**
 - **Output Rounding Mode:** Choose one of the following.
 - Full_Precision
 - Truncate_LSBs
 - Non_Symmetric_Rounding_Down
 - Non_Symmetric_Rounding_Up
 - Symmetric_Rounding_to_Zero
 - Symmetric_Rounding_to_Infinity
 - Convergent_Rounding_to_Even
 - Convergent_Rounding_to_Odd
 - **Output Width:** Specify the output width. Edit box activated only if the Rounding mode is set to a value other than Full_Precision.
- **Detailed Implementation tab:** Parameters specific to the Detailed Implementation tab are as follows.
 - **Filter Architecture:** The following two filter architectures are supported.
 - Systolic_Multiply_Accumulate

- **Transpose_Multiply_Accumulate**

Note: When selecting the Transpose Multiply-Accumulate architecture, these limitations apply:

- Symmetry is not exploited. If the **Coefficient Vector** specified on the Filter Specification tab is detected as symmetric, the Sysgen FIR Compiler 7.2 block parameters dialog box will not allow you to select Transpose Multiply Accumulate.
- Multiple interleaved channels are not supported.

- **Optimization Options:**

Specifies if the core is required to operate at maximum possible speed (“Speed” option) or minimum area (“Area” option). The “Area” option is the recommended default and will normally achieve the best speed and area for the design, however in certain configurations, the “Speed” setting might be required to improve performance at the expense of overall resource usage (this setting normally adds pipeline registers in critical paths).

- **Goal:**

- Area
- Speed
- Custom

- **List:** A comma delimited list that specifies which optimizations are implemented by the block. The optimizations are as follows.

- **Data_Path_Fanout:** Adds additional pipeline registers on the data memory outputs to minimize fan-out. Useful when implementing large data width filters requiring multiple DSP slices per multiply-add unit.
- **Pre-Adder_Pipeline:** Pipelines the pre-adder when implemented using fabric resources. This may occur when a large coefficient width is specified.
- **Coefficient_Fanout:** Adds additional pipeline registers on the coefficient memory outputs to minimize fan-out. Useful for Parallel channels or large coefficient width filters requiring multiple DSP slices per multiply-add unit.
- **Control_Path_Fanout:** Adds additional pipeline registers to control logic when Parallel channels have been specified.
- **Control_Column_Fanout:** Adds additional pipeline registers to control logic when multiple DSP columns are required to implement the filter.
- **Control_Broadcast_Fanout:** Adds additional pipeline registers to control logic for fully parallel (one clock cycle per channel per input sample) symmetric filter implementations.
- **Control_LUT_Pipeline:** Pipelines the Look-up tables required to implement the control logic for Advanced Channel sequences.

- **No_BRAM_Read_First_Mode:** Specifies that Block RAM READ-FIRST mode should not be used.
- **Increased speed:** Multiple DSP slice columns are required for non-symmetric filter implementations.
- **Other:** Miscellaneous optimizations.

Note: All optimizations maybe specified but are only implemented when relevant to the core configuration.

- **Memory Options:** The memory type for MAC implementations can either be user-selected or chosen automatically to suit the best implementation options. Note that a choice of “Distributed” might result in a shift register implementation where appropriate to the filter structure. Forcing the RAM selection to be either Block or Distributed should be used with caution, as inappropriate use can lead to inefficient resource usage - the default Automatic mode is recommended for most applications.
 - **Data Buffer Type:** Specifies the type of memory used to store data samples.
 - **Coefficient Buffer Type:** Specifies the type of memory used to store the coefficients.
 - **Input Buffer Type:** Specifies the type of memory to be used to implement the data input buffer, where present.
 - **Output Buffer type:** Specifies the type of memory to be used to implement the data output buffer, where present.
 - **Preference for other storage:** Specifies the type of memory to be used to implement general storage in the datapath.
- **DSP Slice Column Options:**
 - **Multi-Column Support:** For device families with DSP slices, implementations of large high speed filters might require chaining of DSP slice elements across multiple columns. Where applicable (the feature is only enabled for multi-column devices), you can select the method of folding the filter structure across the multiple-columns, which can be Automatic (based on the selected device for the project) or Custom (you select the length of the first and subsequent columns).
 - **Column Configuration:** Specifies the individual column lengths in a comma delimited list. (See the data sheet for a more detailed explanation.)
 - **Inter-Column Pipe Length:** Pipeline stages are required to connect between the columns, with the level of pipelining required being depending on the required system clock rate, the chosen device and other system-level parameters. The choice of this parameter is always left for you to specify.
- **Interface tab:**
 - **Data Channel Options:**

- **TLAST:** TLAST can either be `Not_Required`, in which case the block will not have the port, or `Vector_Framing`, where TLAST is expected to denote the last sample of an interleaved cycle of data channels, or `Packet_Framing`, where the block does not interpret TLAST, but passes the signal to the output DATA channel TLAST with the same latency as the datapath.
- **Output TREADY:** This field enables the `data_tready` port. With this port enabled, the block will support back-pressure. Without the port, back-pressure is not supported, but resources are saved and performance is likely to be higher.
- **Input FIFO:** Selects a FIFO interface for the `S_AXIS_DATA` channel. When the FIFO has been selected, data can be transferred in a continuous burst up to the size of the FIFO (default 16) or, if greater, the number of interleaved data channels. The FIFO requires additional FPGA logic resources.
- **TUSER:** Select one of the following options for the Input and the Output.
 - **Not_Required:** Neither of the uses is required; the channel in question will not have a TUSER field.
 - **User_Field:** In this mode, the block ignores the content of the TUSER field, but passes the content untouched from the input channel to the output channels.
 - **Chan_ID_Field:** In this mode, the TUSER field identifies the time-division-multiplexed channel for the transfer.
 - **User and Chan_ID_Field:** In this mode, the TUSER field will have both a user field and a `chan_id` field, with the `chan_id` field in the least significant bits. The minimal number of bits required to describe the channel will determine the width of the `chan_id` field, e.g. 7 channels will require 3 bits.
- **Configuration Channel Options:**
 - **Synchronization Mode:**
 - **On_Vector:** Configuration packets, when available, are consumed and their contents applied when the first sample of an interleaved data channel sequence is processed by the block. When the block is configured to process a single data channel configuration packets are consumed every processing cycle of the block.
 - **On_Packet:** Further qualifies the consumption of configuration packets. Packets will only be consumed once the block has received a transaction on the `s_axis_data` channel where `s_axis_data_tlast` has been asserted.
 - **Configuration Method:**
 - **Single:** A single coefficient set is used to process all interleaved data channels.
 - **By_Channel:** A unique coefficient set is specified for each interleaved data channel.
- **Reload Channel Options:**

- **Reload Slots:** Specifies the number of coefficient sets that can be loaded in advance. Reloaded coefficients are only applied to the block once the configuration packet has been consumed. (Range 1 to 256).
- **Control Options:**
 - **ACLKEN:** Active-high clock enable. Available for MAC-based FIR implementations.
 - **ARESETn (active low):** Active-low synchronous clear input that always takes priority over ACLKEN. A minimum ARESETn active pulse of two cycles is required, since the signal is internally registered for performance. A pulse of one cycle resets the control and datapath of the core, but the response to the pulse is not in the cycle immediately following.
- **Advanced tab:**
 - **Block Icon Display:**
 - **Display shortened port names:**

On by default. When unchecked, data_tvalid, for example, becomes m_axis_data_tvalid.

Other parameters used by this block are explained in the topic [Common Options in Block Parameter Dialog Boxes](#).

LogiCORE Documentation

[LogiCORE IP FIR Compiler v7.2](#)

Gateway In

This block is listed in the following Xilinx® Blockset libraries: Basic Elements, Data Types, Floating-Point, and Index.

The Xilinx Gateway In blocks are the inputs into the Xilinx portion of your Simulink® design. These blocks convert Simulink® integer, double, and fixed-point data types into the System Generator fixed-point type. Each block defines a top-level input port or interface in the HDL design generated by System Generator.



Conversion of Simulink Data to System Generator Data

A number of different Simulink data types are supported on the input of Gateway In. The data types supported include int8, uint8, int16, uint16, in32, uint32, single, double, and Simulink fixed point data type (if Simulink fixed point data type license is available). In all causes the input data is converted to a double internal to gateway and then converted to target data type as specified on the Gateway In block (Fixed Point, Floating Point or Boolean). When converting to Fixed point from the internal double representation, the Quantization and Overflow is further handled as specified in the Block GUI. For overflow, the options are to saturate to the largest positive/smallest negative value, to wrap (for example, to discard bits to the left of the most significant representable bit), or to flag an overflow as a Simulink error during simulation. For quantization, the options are to round to the nearest representable value (or to the value furthest from zero if there are two equidistant nearest representable values), or to truncate (for example, to discard bits to the right of the least significant representable bit). It is important to realize that conversion, overflow and quantization do not take place in hardware, they take place only in the simulation model of the block.

Gateway Blocks

As listed below, the Xilinx *Gateway In* block is used to provide a number of functions:

- Converting data from Simulink integer, double and fixed-point type to the System Generator fixed-point type during simulation in Simulink.
- Defining top-level input ports or interface in the HDL design generated by System Generator.
- Defining test bench stimuli when the **Create Testbench** box is checked in the System Generator token. In this case, during HDL code generation, the inputs to the block that occur during Simulink simulation are logged as a logic vector in a data file. During HDL simulation, an entity that is inserted in the top level test bench checks this vector and the corresponding vectors produced by Gateway Out blocks against expected results.
- Naming the corresponding port in the top level HDL entity.

Block Parameters

The block parameters dialog box can be invoked by double-clicking the icon in your Simulink model.

- **Basic tab:**

Parameters specific to the Basic tab are as follows.

- **Output Type:**

Specifies the output data type. Can be **Boolean**, **Fixed-point**, or **Floating-point**.

- **Arithmetic Type:** If the Output Type is specified as Fixed-point, you can select **Signed (2's comp)** or **Unsigned** as the Arithmetic Type.

- **Fixed-point Precision:**

- **Number of bits:** Specifies the total number of bits, including the binary point bit width.
- **Binary point:** Specifies the bit location of the binary point, where bit zero is the least significant bit.

- **Floating-point Precision:**

- **Single:** Specifies single precision (32 bits).
- **Double:** Specifies double precision (64 bits).
- **Custom:** Activates the field below so you can specify the Exponent width and the Fraction width.
- **Exponent width:** Specify the exponent width.
- **Fraction width:** Specify the fraction width.

- **Quantization:**

Quantization errors occur when the number of fractional bits is insufficient to represent the fractional portion of a value. The options are to **Truncate** (for example, to discard bits to the right of the least significant representable bit), or to **Round(unbiased: +/- inf)** or **Round (unbiased: even values)**.

- **Round(unbiased: +/- inf):**

Also known as "Symmetric Round (towards +/- inf)" or "Symmetric Round (away from zero)". This is similar to the MATLAB® `round()` function. This method rounds the value to the nearest desired bit away from zero and when there is a value at the midpoint between two possible rounded values, the one with the larger magnitude is selected. For example, to round 01.0110 to a Fix_4_2, this yields 01.10, since 01.0110 is exactly between 01.01 and 01.10, and the latter is further from zero.

- **Overflow:**

Overflow errors occur when a value lies outside the representable range. For overflow the options are to **Saturate** to the largest positive/smallest negative value, to **Wrap** (for example, to discard bits to the left of the most significant representable bit), or to **Flag as error** (an overflow as a Simulink® error) during simulation. **Flag as error** is a simulation only feature. The hardware generated is the same as when **Wrap** is selected.

- **Implementation tab:**

Parameters specific to the Implementation tab are as follows.

- **Interface Options:**

- **Interface:**

- **None:** Implies that during HDL Netlist generation, this Gateway In will be translated as an Input Port at the top level.
- **AXI4-Lite:** Implies that during HDL Netlist generation, an AXI4-Lite interface will be created and this Gateway In will be mapped to one of the registers within the AXI4-Lite interface.
- **Auto assign address offset:**

If the Gateway In is configured to be an AXI4-Lite interface, this option allows an address offset to be automatically assigned to the register within the AXI4-Lite interface that the Gateway In is mapped to.
- **Address offset:** If Auto assign address offset is not checked, then this entry box allows you to explicitly specify an address offset to use. Must be a multiple of 4.
- **Interface Name:** If the Gateway In is configured to be an AX4-Lite interface, assigns a unique name to this interface. This name can be used to differentiate between multiple AXI4-Lite interfaces in the design. When using the IP Catalog flow, you can expect to see an interface in the IP that System Generator creates with the name `<design_name>_<interface_name>_s_axi`.

 **IMPORTANT!** *The **Interface Name** must be composed of alphanumeric characters (lowercase alphabetic) or an underscore (_) only, and must begin with a lowercase alphabetic character. `axi4_lite1` is acceptable, `1Axi4-Lite` is not.*

- **Description:** Additional designer comments about this Gateway In that is captured in the interface documentation.
- **Constraints:**
 - **IOB Timing Constraint:** In hardware, a Gateway In is realized as a set of input/output buffers (IOBs). There are two constraint options: None, and Data Rate.

If None is selected, no timing constraints for the IOBs are put in the user constraint file produced by System Generator. This means the paths from the IOBs to synchronous elements are not constrained.

If Data Rate is selected, the IOBs are constrained at the data rate at which the IOBs operate. The rate is determined by System Clock Period provided on the System Generator token and the sample rate of the Gateway relative to the other sample periods in the design.
 - **Specify IOB location constraints:** Checking this option allows IOB location constraints and I/O standards to be specified.
 - **IOB pad locations, e.g. {'MSB', ..., 'LSB'}:** IOB pin locations can be specified as a cell array of strings in this edit box. The locations are package-specific.

- **IO Standards, e.g. {'MSB', ..., 'LSB'}:** I/O standards can be specified as a cell array of strings in this edit box. The locations are package-specific.

Gateway Out

This block is listed in the following Xilinx® Blockset libraries: Basic Elements, Data Types, Floating-Point, and Index.

Xilinx Gateway Out blocks are the outputs from the Xilinx portion of your Simulink® design. This block converts the System Generator fixed-point or floating-point data type into a Simulink integer, single, double or fixed-point data type.



According to its configuration, the Gateway Out block can either define an output port for the top level of the HDL design generated by System Generator, or be used simply as a test point that is trimmed from the hardware representation

Gateway Blocks

As listed below, the Xilinx Gateway Out block is used to provide the following functions:

- Convert data from a System Generator fixed-point or floating-point data type into a Simulink integer, single, double, or fixed-point data type.
- Define I/O ports for the top level of the HDL design generated by System Generator. A Gateway Out block defines a top-level output port.
- Define test bench result vectors when the System Generator **Create Testbench** box is checked. In this case, during HDL code generation, the outputs from the block that occur during Simulink simulation are logged as logic vectors in a data file. For each top level port, an HDL component is inserted in the top-level test bench that checks this vector against expected results during HDL simulation.
- Name the corresponding output port on the top-level HDL entity.

Block Parameters

- **Basic tab:** Parameters specific to the Basic tab are as follows.
 - **Propagate data type to output:** This option is useful when you instantiate a System Generator design as a sub-system into a Simulink design. Instead of using a Simulink double as the output data type by default, the System Generator data type is propagated to an appropriate Simulink data type according to the following table:

Table 16: Propagate Data Type Output

System Generator Data Type	Simulink Data Type
XFloat_8_24	single
XFloat_11_53	double
Custom floating-point precision data type exponent width and fraction width less than those for single precision	single
Custom floating-point precision data type with exponent width or fraction width greater than that for single precision	double
XFix_<width>_<binpt>	sfix<width>_EN<binpt>
UFix_<width>_<binpt>	ufix<width>_EN<binpt>
XFix_<width>_0 where width is 8, 16 or 32	int<width> where width is 8, 16 or 32
UFix_<width>_0 where width is 8, 16 or 32	uint<width> where width is 8, 16 or 32
XFix_<width>_0 where width is other than 8, 16 or 32	sfix<width>
UFix_<width>_0 where width is other than 8, 16 or 32	ufix<width>

- Translate into Output Port:** Having this box unchecked prevents the gateway from becoming an actual output port when translated into hardware. This checkbox is on by default, enabling the output port. When this option is not selected, the Gateway Out block is used only during debugging, where its purpose is to communicate with Simulink Sink blocks for probing portions of the design. In this case, the Gateway Out block will turn gray in color, indicating that the gateway will not be translated into an output port.
- Implementation tab:** Parameters specific to the Implementation tab are as follows.
 - Interface Options:**
 - Interface:**
 - None:** During HDL Netlist generation, this Gateway Out will be translated as an Output Port at the top level.
 - AXI4-Lite:** During HDL Netlist Generation, an AXI4-Lite interface will be created and the Gateway Out will be mapped to one of the registers within the AXI4-Lite interface.
 - Interrupt:** During an IP Catalog Generation, this Gateway Out will be tagged as an Interrupt output port when the System Generator design is packaged into an IP module that can be included in the Vivado® IP catalog.
 - Auto assign address offset:** If a Gateway Out is configured to be an AXI4-Lite interface, this option allows an address offset to be automatically assigned to the register within the AXI4-Lite interface that the Gateway Out is mapped to.
 - Address offset:** If Auto assign address offset is not checked, then this entry box allows you to explicitly specify a address offset to use. Must be a multiple of 4.

- **Interface Name:** If the Gateway Out is configured to be an AX4-Lite interface, assigns a unique name to this interface. This name can be used to differentiate between multiple AXI4-Lite interfaces in the design. When using the IP Catalog flow, you can expect to see an interface in the IP that System Generator creates with the name `<design_name>_<interface_name>_s_axi`.

★ **IMPORTANT!** The **Interface Name** must be composed of alphanumeric characters (lowercase alphabetic) or an underscore (`_`) only, and must begin with a lowercase alphabetic character. `axi4_lite1` is acceptable, `1Axi4-Lite` is not.

- **Description:** Additional designer comments about this Gateway Out that is captured in the interface documentation.
- **Constraints:**
 - **IOB Timing Constraint:** In hardware, a Gateway Out is realized as a set of input/output buffers (IOBs). There are three ways to constrain the timing on IOBs. They are None, Data Rate, and Data Rate, Set 'FAST' Attribute.

If **None** is selected, no timing constraints for the IOBs are put in the user constraint file produced by System Generator. This means the paths from the IOBs to synchronous elements are not constrained.

If **Data Rate** is selected, the IOBs are constrained at the data rate at which the IOBs operate. The rate is determined by System Clock Period provided on the System Generator token and the sample rate of the Gateway relative to the other sample periods in the design. For example, the following `OFFSET = OUT` constraints are generated for a Gateway Out named 'Dout' that is running at the system period of 10 ns:

```
# Offset out constraints
NET "Dout(0)" OFFSET = OUT : 10.0 : AFTER "clk";
NET "Dout(1)" OFFSET = OUT : 10.0 : AFTER "clk";
NET "Dout(2)" OFFSET = OUT : 10.0 : AFTER "clk";
```

If **Data Rate, Set 'FAST' Attribute** is selected, the `OFFSET = OUT` constraints described above are produced. In addition, a FAST slew rate attribute is generated for each IOB. This reduces delay but increases noise and power consumption. For the previous example, the following additional attributes are added to the constraints file.

```
NET "Dout(0)" FAST;
NET "Dout(1)" FAST;
NET "Dout(2)" FAST;
```

- **Specify IOB Location Constraints:** Checking this option allows IOB location constraints to be specified.

- **IOB Pad Locations, e.g. {'MSB', ..., 'LSB'}:** IOB pin locations can be specified as a cell array of strings in this edit box. The locations are package-specific.

Other parameters used by this block are explained in the topic [Common Options in Block Parameter Dialog Boxes](#).

Indeterminate Probe

This block is listed in the following Xilinx Blockset libraries: Tools and Index.

The output of the Xilinx Indeterminate Probe indicates whether the input data is indeterminate (MATLAB value NaN). An indeterminate data value corresponds to a VHDL indeterminate logic data value of 'X'.

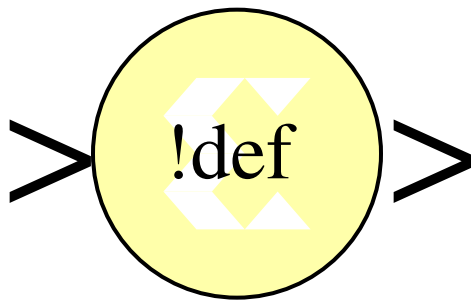

The probe accepts any Xilinx signal as input and produces a double signal as output. Indeterminate data on the probe input will result in an assertion of the output signal indicated by a value one. Otherwise, the probe output is zero.

Interleaver/De-interleaver 8.0

This block is listed in the following Xilinx® Blockset libraries: AXI, Communication, and Index.

Note: This block goes into the FPGA fabric and is a Licensed Core. Please visit the Xilinx web site to purchase the appropriate core license.

The Xilinx Interleaver Deinterleaver block implements an interleaver or a deinterleaver using an AXI4-compliant block interface. An interleaver is a device that rearranges the order of a sequence of input symbols. The term symbol is used to describe a collection of bits. In some applications, a symbol is a single bit. In others, a symbol is a bus.

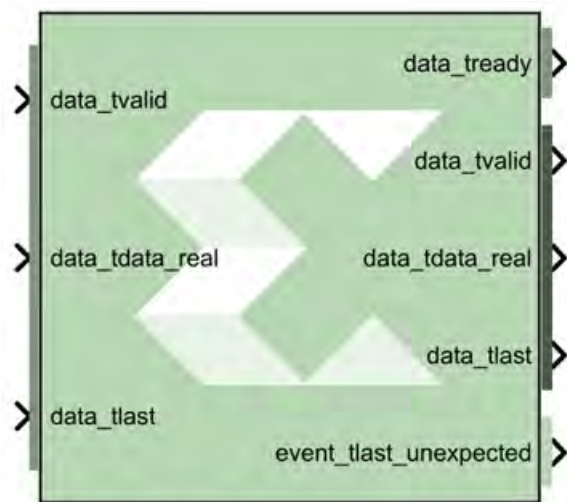

The classic use of interleaving is to randomize the location of errors introduced in signal transmission. Interleaving spreads a burst of errors out so that error correction circuits have a better chance of correcting the data.

If a particular interleaver is used at the transmit end of a channel, the inverse of that interleaver must be used at the receive end to recover the original data. The inverse interleaver is referred to as a de-interleaver.

Two types of interleaver/de-interleavers can be generated with this LogiCORE™: Forney Convolutional and Rectangular Block. Although they both perform the general interleaving function of rearranging symbols, the way in which the symbols are rearranged and their methods of operation are entirely different. For very large interleavers, it might be preferable to store the data symbols in external memory. The core provides an option to store data symbols in internal FPGA RAM or in external RAM.

Forney Convolutional Operation

The figure below, shows the operation of a Forney Convolutional Interleaver. The core operates as a series of delay line shift registers. Input symbols are presented to the input commutator arm on DIN. Output symbols are extracted from the output commutator arm on DOUT. DIN and DOUT are fields in the AXI Data Input and Data Output channels, respectively. Output symbols are extracted from the output commutator arm on DOUT. Both commutator arms start at branch 0 and advance to the next branch after the next rising clock edge. After the last branch (B-1) has been reached, the commutator arms both rotate back to branch 0 and the process is repeated.

Figure 35: Interleaver

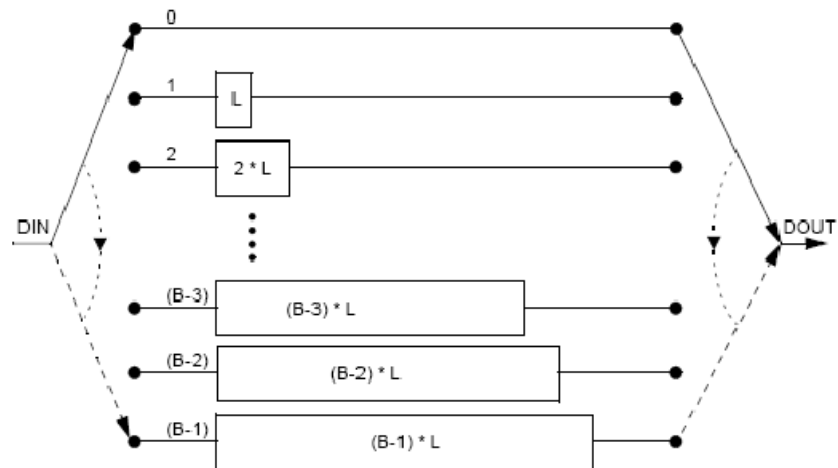

In the figure above, the branches increase in length by a uniform amount, L . The core allows interleavers to be specified in this way, or the branch lengths can be passed in using a file, allowing each branch to be any length.

Although branch 0 appears to be a zero-delay connection, there will still be a delay of a number of clock cycles between DIN and DOUT because of the fundamental latency of the core. For clarity, this is not illustrated in the figure.

The only difference between an interleaver and a de-interleaver is that branch 0 is the longest in the de-interleaver and the branch length is decremented by L rather than incremented. Branch $(B-1)$ has length 0. This is illustrated in the figure below:

Figure 36: De-interleaver

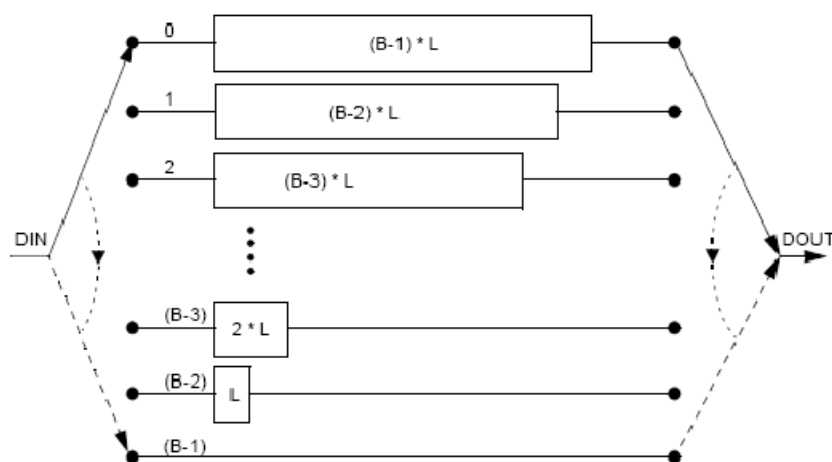

If a file is used to specify the branch lengths, as shown below, it is arbitrary whether the resulting core is called an interleaver or de-interleaver. All that matters is that one must be the inverse of the other. If a file is used, each branch length is individually controllable. This is illustrated in the figure below. For the file syntax, please consult the LogiCORE product specification.

Figure 37: Interleaver/De-Interleaver

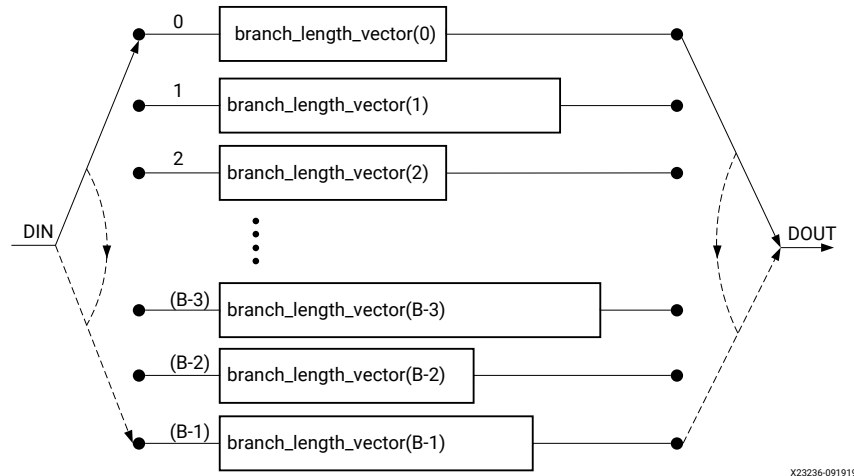

The reset pin (aresetn) sets the commutator arms to branch 0, but does not clear the branches of data.

Configuration Swapping

It is possible for the core to store a number of pre-defined configurations. Each configuration can have a different number of branches and branch length constant. It is even possible for each configuration to have every individual branch length defined by file.

The configuration can be changed at any time by sending a new CONFIG_SEL value on the AXI Control Channel. This value takes effect when the next block starts. The core assumes all configurations are either for an interleaver or de-interleaver, depending on what was selected in the GUI. It is possible to switch between interleaving and de-interleaving by defining the individual branch lengths for every branch of each configuration. The details for each configuration are specified in a COE file.

For details, please consult the Configuration Swapping section of the *Interleaver/De-Interleaver LogiCORE IP Product Guide* (PG049).

Rectangular Block Operation

The Rectangular Block Interleaver works by writing the input data symbols into a rectangular memory array in a certain order and then reading them out in a different, mixed-up order. The input symbols must be grouped into blocks. Unlike the Convolutional Interleaver, where symbols can be continuously input, the Rectangular Block Interleaver inputs one block of symbols and then outputs that same block with the symbols rearranged. No new inputs can be accepted while the interleaved symbols from the previous block are being output.

The rectangular memory array is composed of a number of rows and columns as shown in the following figure.

Row\Column	0	1	...	(C-2)	(C-1)
0					
1					
..					
(R-2)					
(R-1)					

The Rectangular Block Interleaver operates as follows:

1. All the input symbols in an entire block are written row-wise, left to right, starting with the top row.
2. Inter-row permutations are performed if required.
3. Inter-column permutations are performed if required.
4. The entire block is read column-wise, top to bottom, starting with the left column.

The Rectangular Block De-interleaver operates in the reverse way:

1. All the input symbols in an entire block are written column-wise, top to bottom, starting with the left column.
2. Inter-row permutations are performed if required.
3. Inter-column permutations are performed if required.
4. The entire block is read row-wise, left to right, starting with the top row.

Refer to the *Interleaver/De-Interleaver LogiCORE IP Product Guide (PG049)* for examples and more detailed information on the Rectangular Block Interleaver.

AXI Interface

The AXI SID v7.1 has the following interfaces:

- A non AXI-channel interface for ACLK, ACLKEN and ARESETn
- A non AXI-channel interface for external memory (if enabled)

- A non AXI-channel interface for miscellaneous events
 - event_tlast_unexpected
 - event_tlast_missing (available only in Rectangular mode)
 - event_halted (optional, available when Master channel TREADY is enabled)
 - event_col_valid (optional)
 - event_col_sel_valid (optional)
 - event_row_valid (optional)
 - event_row_sel_valid (optional)
 - event_block_size_valid (optional)
- An AXI slave channel to receive configuration information (s_axis_ctrl) consisting of:
 - s_axis_ctrl_tvalid
 - s_axis_ctrl_tready
 - s_axis_ctrl_tdata

The control channel is only enabled when the core is configured in such a way to require it.

- An AXI slave channel to receive the data to be interleaved (s_axis_data) consisting of:
 - s_axis_data_tvalid (This is the equivalent of ND pin of SID v6.0 block; No longer optional)
 - s_axis_data_tready
 - s_axis_data_tdata
 - s_axis_data_tlast
- An AXI master channel to send the data that has been interleaved (m_axis_data) consisting of:
 - m_axis_data_tvalid
 - m_axis_data_tready
 - m_axis_data_tdata
 - m_axis_data_tuser
 - m_axis_data_tlast

AXI Ports that are Unique to this Block

This System Generator block exposes the AXI Control and Data channels as a group of separate ports based on the following sub-field names.

Note: Refer to the document [LogiCORE IP Interleaver/De-interleaver v8.0](#) for an explanation of the bits in the specified sub-field name.

- **Control Channel Input Signals:**

- **s_axis_ctrl_tdata_config_sel:**

A sub-field port that represents the CONFIG_SEL field in the Control Channel vector. Available when in Forney mode and Number of configurations is greater than one.

- **s_axis_ctrl_tdata_row:**

A sub-field port that represents the ROW field in the Control Channel vector. Available when in Rectangular mode and Row type is Variable.

- **s_axis_ctrl_tdata_row_sel:**

A sub-field port that represents the ROW_SEL field in the Control Channel vector. Available when in Rectangular mode and Row type is Selectable.

- **s_axis_ctrl_tdata_col:** A sub-field port that represents the COL field in the Control Channel vector. Available when in Rectangular mode and Column type is Variable.

- **s_axis_ctrl_tdata_col_sel:**

A sub-field port that represents the COL_SEL field in the Control Channel vector. Available when in Rectangular mode and Column type is Selectable.

- **s_axis_ctrl_tdata_block_size:** A sub-field port that represents the COL field in the Control Channel vector. Available when in Rectangular mode and Block Size type is Variable.

- **DATA Channel Input Signals:**

- **s_axis_data_tdata_din:**

Represents the DIN field of the Input Data Channel.

- **DATA Channel Output Signals:**

- **m_axis_data_tdata_dout:**

Represents the DOUT field of the Output Data Channel.

- **TUSER Channel Output Signals:**

- **m_axis_data_tuser_fdo:** Represents the FDO field of the Output TUSER Channel. Available when in Forney mode and Optional FDO pin has been selected on the GUI.

- **m_axis_data_tuser_rdy:** Represents the RDY field of the Output TUSER Channel. Available when in Forney mode and Optional RDY pin has been selected on the GUI.

- **m_axis_data_tuser_block_start:** Represents the BLOCK_START field of the Output TUSER Channel. Available when in Rectangular mode and Optional BLOCK_START pin has been selected on the GUI.
- **m_axis_data_tuser_block_end:** Represents the BLOCK_END field of the Output TUSER Channel. Available when in Rectangular mode and Optional BLOCK_END pin has been selected on the GUI.

Block Parameters

The block parameters dialog box can be invoked by double-clicking the icon in your Simulink model.

- **Basic tab:** Parameters specific to the Basic Parameters tab are as follows.
 - **Memory Style:** Select **Distributed** if all the Block Memories are required elsewhere in the design; select **Block** to use Block Memory where ever possible; select **Automatic** and let System Generator use the most appropriate style of memory for each case, based on the required memory depth.
 - **Symbol Width:** This is the number of bits in the symbols to be processed.
 - **Type:** Select **Forney Convolutional** or **Rectangular Block**.
 - **Mode:** Select **Interleaver** or **Deinterleaver**
 - **Symbol memory:** Specifies whether or not the data symbols are stored in Internal FPGA RAM or in External RAM.
- **Forney tab:** Parameters specific to the Forney Parameters tab are as follows.
 - **Dimensions:**
 - **Number of branches:** 1 to 256 (inclusive)
 - **Architecture:**
 - **ROM-based:** Look-up table ROMs are used to compute some of the internal results in the block.
 - **Logic-based:** Logic circuits are used to compute some of the internal results in the block.

Which option is best depends on the other core parameters. You should try both options to determine the best results. This parameter has no effect on the block behavior.
- **Configurations:**
 - **Number of configurations:** If greater than 1, the block is generated with CONFIG_SEL and NEW_CONFIG inputs. The parameters for each configuration are defined in a COE file. The number of parameters defined must exactly match the number of configurations specified.

- **Length of Branches:** Branch length descriptions for Forney SID.
 - **constant_difference_between_consecutive_branches:** Specified by the Value parameter.
 - **use_coe_file_to_define_branch_lengths:** Location of file is specified by the COE File parameter.
 - **coe_file_defines_individual_branch_lengths_for_every_branch_in_each_configuration:** Location of file is specified by the COE File parameter.
 - **coe_file_defines_branch_length_constant_for_each_configuration:** Location of file is specified by the COE File parameter.
 - **Value:** 1 to MAX (inclusive). MAX depends on the number of branches and size of block input. Branch length must be an array of either length one or number of branches. If the array size is one, the value is used as a constant difference between consecutive branches. Otherwise, each branch has a unique length.
 - **COE File:** The branch lengths are specified from a file
- **Rectangular Parameters #1 Tab:** Parameters specific to the Rectangular Parameters #1 tab are as follows.
 - **Number of Rows:**
 - **Value:** This parameter is relevant only when the Constant row type is selected. The number of rows is fixed at this value.
 - **Row Port Width:** This parameter is relevant only when the Variable row type is selected. It sets the width of the ROW input bus. The smallest possible value should be used to keep the underlying LogiCORE as small as possible.
 - **Minimum Number of Rows:** This parameter is relevant only when the Variable row type is selected. In this case, the core has to potentially cope with a wide range of possible values for the number of rows. If the smallest value that will actually occur is known, then the amount of logic in the LogiCORE can sometimes be reduced. The largest possible value should be used for this parameter to keep the core as small as possible.
 - **Number of Values:** This parameter is relevant only when you select the **Selectable** row type. This parameter defines how many valid selection values have been defined in the COE file. You should only add the number of select values you need.
 - **Row Type:**
 - **Constant:** The number of rows is always equal to the Row Constant Value parameter.
 - **Variable:** The number of rows is sampled from the ROW input at the start of each new block. Row permutations are not supported for the variable row type.
 - **Selectable:** ROW_SEL is sampled at the start of each new block. This value is then used to select from one of the possible values for the number of rows provided in the COE file.

- **Number of Columns:**
 - **Value:** This parameter is relevant only when you select the **Constant** column type is selected. The number of columns is fixed at this value.
 - **COL Port Width:** This parameter is relevant only when you select the Variable column type. It sets the width of the COL input bus. The smallest possible value should be used to keep the underlying LogiCORE™ as small as possible.
 - **Minimum Number of Columns:** This parameter is relevant only when you select the **Variable** column type is selected. In this case, the core has to potentially cope with a wide range of possible values for the number of columns. If the smallest value that will actually occur is known, then the amount of logic in the LogiCORE can sometimes be reduced. The largest possible value should be used for this parameter to keep the core as small as possible.
 - **Number of Values:** This parameter is relevant only when you select the **Selectable** column type. This parameter defines how many valid selection values have been defined in the COE file. You should only add the number of select values you need.
 - **Column Type:**
 - **Constant:** The number of columns is always equal to the Column Constant Value parameter.
 - **Variable:** The number of columns is sampled from the COL input at the start of each new block. Column permutations are not supported for the variable column type.
 - **Selectable:** COL_SEL is sampled at the start of each new block. This value is then used to select from one of the possible values for the number of columns provided in the COE file.
- **Rectangular Parameters #2 Tab:** Parameters specific to the Rectangular Parameters #2 tab are as follows.
 - **Permutations Configuration:**
 - **Row permutations:**
 - **None:** This tells System Generator that row permutations are not to be performed.
 - **Use COE file:** This tells System Generator that a row permute vector exists in the COE file, and that row permutations are to be performed. Remember this is possible only for un-pruned interleaver/deinterleavers.
 - **Column permutations:**
 - **None:** This tells System Generator that column permutations are not to be performed
 - **Use COE file:** This tells System Generator that a column permute vector exists in the COE file, and that column permutations are to be performed. Remember this is possible only for un-pruned interleaver/deinterleavers.

- **COE File:** Specify the pathname to the COE file.
- **Block Size:**
 - **Value:** This parameter is relevant only when you select the **Constant** block size type. The block size is fixed at this value.
 - **BLOCK_SIZE Port Width:** This parameter is relevant only if the Variable block size type is selected. It sets the width of the BLOCK_SIZE input bus. The smallest possible value should be used to keep the core as small as possible.
- **Block Size Type:**
 - **Constant:** The block size never changes. The block can be pruned (block size < row * col). The block size must be chosen so that the last symbol is on the last row. An unpruned interleaver will use a smaller quantity of FPGA resources than a pruned one, so pruning should be used only if necessary.
 - **Rows*Columns:**

If the number of rows and columns is constant, selecting this option has the same effect as setting the block size type to constant and entering a value of rows * columns for the block size.

If the number of rows or columns is not constant, selecting this option means the core will calculate the block size automatically whenever a new row or column value is sampled. Pruning is impossible with this block size type.
 - **Variable:**

Block size is sampled from the BLOCK_SIZE input at the beginning of every block. The value sampled on BLOCK_SIZE must be such that the last symbol falls on the last row, as previously described.

If the block size is already available external to the core, selecting this option is usually more efficient than selecting “rows * columns” for the block size type. Row and column permutations are not supported for the Variable block size type.
- **Port Parameters #1 tab:** Parameters specific to the Port Parameters tab are as follows.
 - **Control Signals:**
 - **ACLKEN:** When ACLKEN is de-asserted (Low), all the synchronous inputs are ignored and the block remains in its current state.
 - **ARESETn (Active-Low):** The Active-Low synchronous clear input always takes priority over ACLKEN.
 - **Status Signals:**

- **COL_VALID:** This optional output is available when a variable number of columns is selected. If an illegal value is sampled on the `s_axis_ctrl_tdata_col` input, `event_col_valid` will go Low a predefined number of clock cycles later.
- **COL_SEL_VALID:** This optional output (`event_col_sel_valid`) is available when a selectable number of columns is chosen. The event pins are `event_col_valid`, `event_col_sel_valid`, `event_row_valid`, `event_row_sel_valid`, `event_block_size_valid` (in the same order as in the options on the GUI).
- **ROW_VALID:** This optional output is available when a selectable number of rows is chosen.
- **ROW_SEL_VALID:** This optional output is available when a selectable number of rows is chosen.
- **BLOCK_SIZE_VALID:** This optional output is available when the block size is not constant, that is, if the block size type is either Variable or equal to Rows * Columns.
- **Port Parameters #2 tab:** Parameters specific to the Port Parameters #2 tab are as follows.
 - **Data Output Channel Options:**
 - **TREADY:** TREADY for the Data Input Channel. Used by the Symbol Interleaver/De-interleaver to signal that it is ready to accept data.
 - **FDO:** Adds a `data_tuser_fdo` (First Data Out) output port.
 - **RDY:** Adds a `data_tuser_rdy` output port.
 - **BLOCK_START:** Adds a `data_tuser_block_start` output port.
 - **BLOCK_END:** Adds a `data_tuser_block_end` output port.
 - **Pipelining:**
 - **Pipelining:** Pipelines the underlying LogiCORE for Minimum, Medium, or Maximum performance.

Other parameters used by this block are explained in the topic [Common Options in Block Parameter Dialog Boxes](#).

LogiCORE Documentation

[LogiCORE IP Interleaver/De-interleaver v8.0](#)

Inverse FFT

This block is listed in the following Xilinx® Blockset libraries: DSP, Floating-Point, and Index.

The Xilinx Inverse FFT block performs a fast inverse (or backward) Fourier transform (IDFT), which undoes the process of Discrete Fourier Transform (DFT). The Inverse FFT maps the signal back from the frequency domain into the time domain.

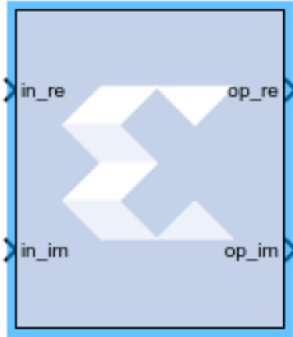

The IDFT of a sequence $\{F_n\}$ can be defined as:

$$x(n) = \frac{1}{N} \sum_{k=0}^{N-1} X[k] e^{j \frac{2\pi}{N} nk} \quad \text{for } n=0, 1, 2, \dots, N-1$$

where N is the transform length, k is used to denote the frequency domain ordinal, and n is used to represent the time-domain ordinal.

The Inverse FFT (IFFT) is computed by conjugating the phase factors of the corresponding forward FFT.

The Inverse FFT block is ideal for implementing simple inverse Fourier transforms. If your Inverse FFT implementation will use more complicated transform features such as an AXI4-Stream-compliant interface, a real time throttle scheme, Radix-4 Burst I/O, or Radix-2 Lite Burst I/O, use the Xilinx [Fast Fourier Transform 9.1](#) block in your design instead of the Inverse FFT block.

In the Vivado® design flow, the Inverse FFT block is inferred as "LogiCORE™ IP Fast Fourier Transform v9.1" for code generation. Refer to the document [LogiCORE IP Fast Fourier Transform v9.1](#) for details on this LogicCore IP.

Block Parameters

The block parameters dialog box can be invoked by double-clicking the icon in your Simulink® model.

Parameters specific to the Xilinx Inverse FFT block are:

- **Transform Length:** Select the desired point size ranging from 8 to 65536.

- **Scale Result by FFT length:** If selected, data is scaled between IFFT stages using a scaling schedule determined by the Transform Length setting. If not selected, data is unscaled, and all integer bit growth is carried to the output.
- **Natural Order:** If selected, the output of the Inverse FFT block will be ordered in natural order. If not selected, the output of the Inverse FFT block will be ordered in bit/digit reversed order.
- **Optimize for:** Directs the block to be optimized for either speed (Performance) or area (Resources) in the generated hardware.

Note: If you selected **Resources** and the input sample period is 8 times slower than the system sample period, the block implements Radix-2 Burst I/O architecture. Otherwise, Pipeline Streaming I/O architecture is used.

- **Optional Port:**
 - **Provide start frame port:** Adds `start_frame_in` and `start_frame_out` ports to the block. The signals on these ports can be used to synchronize frames at the input and output of the Inverse FFT block. See [Adding Start Frame Ports to Synchronize Frames](#) for a description of the operation of these two ports.

Context Based Pipeline vs. Radix Implementation

Pipelined Streaming I/O and Radix-2 Burst I/O architectures are supported by the Inverse FFT block. Radix-4 Burst I/O architecture is implemented when the **Optimize for: Resources** block parameter is selected and the sample rate of the inputs is 8 times slower than the system rate. In all other configurations Pipelined Streaming I/O architecture is implemented by default.

Input Data Type Support

The Inverse FFT block accepts inputs of varying bit widths with changeable binary point location, such as `Fix_16_0` or `Fix_30_10`, etc. in unscaled block configuration. For the scaled configuration, the input is supported in the same format as the [Fast Fourier Transform 9.1](#) block. The [Fast Fourier Transform 9.1](#) block accepts input values only in the normalized form in the format of `Fix_x_[x-1]` (for example, `Fix_16_15`), so the inputs are 2's complement with a single sign/integer bit.

Latency Value Displayed on the Block

The latency value depends on parameters selected by the user, and the corresponding latency value is displayed on the Inverse FFT block icon in the Simulink model.

Automatic Fixed Point and Floating Point Support

Signed fixed point and floating point data types are supported.

For floating point input, either scaled or unscaled data can be selected in the Inverse FFT block parameters. In the [Fast Fourier Transform 9.1](#) block, the floating point data type is accepted only when the scaled configuration is selected by the user.

Handling Overflow for Scaled Configuration

The Inverse FFT block uses a conservative schedule to avoid overflow scenarios. This schedule sets the scaling value for the corresponding FFT stages in a way that makes sure no overflow occurs.

Adding Start Frame Ports to Synchronize Frames

Selecting **Provide start frame port** in the Inverse FFT block properties dialog box adds `start_frame_in` and `start_frame_out` ports at the input and output of the Inverse FFT block. These ports are used to synchronize frames at the input and output of the Inverse FFT block.

Figure 38: Adding Start Frame Ports

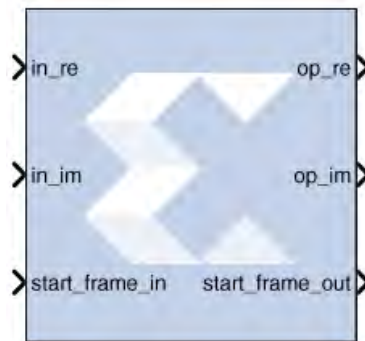

You must provide a valid input at the `start_frame_in` port. When the `start_frame_in` signal is asserted, an impulse is generated at the start of every frame to signal the Inverse FFT block to start processing the frame. The frame size is the Transform Length entered in the block parameters dialog box.

The `start_frame_out` port provides the information as to when the output frames start. An impulse at the start of every frame on the output side helps in tracking the block behavior.

The Inverse FFT block has a frame alignment requirement and these ports help the block operate in accordance with this requirement.

The figure below shows that as soon as the output is processed by the Inverse FFT block the `start_frame_out` signal becomes High (1).

Figure 39: Output

re_data_out	000280	000000	000280
img_data_out	000280	000000	000280
start_frame_out	1	0	1

The following apply to the **Provide start frame port** option and the start frame ports added to the FFT block when the option is enabled:

- The **Provide start frame port** option selection is valid only for Pipelined Streaming I/O architecture. See [Context Based Pipeline vs. Radix Implementation](#) for a description of the conditions under which Pipelined Streaming I/O architecture is implemented.
- The option is valid only for input of type fixed point.
- Verilog is supported for netlist generation currently, when the **Provide start frame port** option is selected.

Note: The first sample input to the Inverse FFT block may be ignored and users are advised to drive the input data accordingly.

LogiCORE Documentation

[LogiCORE IP Fast Fourier Transform v9.1](#)

Inverter

This block is listed in the following Xilinx® Blockset libraries: Basic Elements, Control Logic, Math, and Index.

The Xilinx Inverter block calculates the bitwise logical complement of a fixed-point number. The block is implemented as a synthesizable VHDL module.



Block Parameters

The block parameters dialog box can be invoked by double-clicking the icon in your Simulink® model.

Other parameters used by this block are explained in the topic [Common Options in Block Parameter Dialog Boxes](#).

LFSR

This block is listed in the following Xilinx® Blockset libraries: Basic Elements, DSP, Memory, and Index.

The Xilinx LFSR block implements a Linear Feedback Shift Register (LFSR). This block supports both the Galois and Fibonacci structures using either the XOR or XNOR gate and allows a re-loadable input to change the current value of the register at any time. The LFSR output and re-loadable input can be configured as either serial or parallel ports



Block Interface

Table 17: Block Interface

Port Name	Port Description	Port Type
din	Data input for re-loadable seed	Optional serial or parallel input
load	Load signal for din	Optional boolean input
rst	Reset signal	Optional boolean input
en	Enable signal	Optional boolean input
dout	Data output of LFSR	Required serial or parallel output

As shown in the table above, there can be between 0 and 4 block input ports and exactly one output port. If the configuration selected requires 0 inputs, the LFSR is set up to start at a specified initial seed value and will step through a repeatable sequence of states determined by the LFSR structure type, gate type, and initial seed.

The optional din and load ports provide the ability to change the current value of the LFSR at runtime. After the load completes, the LFSR behaves as with the 0 input case, and starts up a new sequence based upon the newly loaded seed, and the statically configured LFSR options for structure and gate type.

The optional `rst` port will reload the statically specified initial seed of the LFSR and continue on as before after the `rst` signal goes low. And when the optional `en` port goes low, the LFSR will remain at its current value with no change until the `en` port goes high again.

Block Parameters

The block parameters dialog box can be invoked by double-clicking the icon in your Simulink® model.

- **Basic tab:** Parameters specific to the Basic tab are as follows:
 - **Type:** Fibonacci or Galois. This field specifies the structure of the feedback. Fibonacci has one XOR (or XNOR) gate at the beginning of the register chain that XORs (or XNORs) the taps together with the result going into the first register. Galois has one XOR(or XNOR) gate for each tap and gates the last register in the chains output with the input to the register at that tap.
 - **Gate type:** XOR or XNOR. This field specifies the gate used by the feedback signals.
 - **Number of bits in LFSR:** This field specifies the number of registers in the LFSR chain. As a result, this number specifies the size of the input and output when selected to be parallel.
 - **Feedback polynomial:** This field specifies the tap points of the feedback chain and the value must be entered in hex with single quotes. The lsb of this polynomial always must be set to 1 and the msb is an implied 1 and is not specified in the hex input. Please see the Xilinx application note titled [Efficient Shift Registers, LFSR Counters, and Long Pseudo-Random Sequence Generators](#) for more information on how to specify this equation and for optimal settings for the maximum repeating sequence.
 - **Initial value:** This field specifies the initial seed value where the LFSR begins its repeating sequence. The initial value might not be all zeroes when choosing the XOR gate type and might not be all ones when choosing XNOR, as those values will stall the LFSR.
- **Advanced tab:** Parameters specific to the Advanced tab are as follows:
 - **Use reloadable seed value :** This field specifies whether or not an input is needed to reload a dynamic LFSR seed value at run time.
 - **Parallel input:** This field specifies whether the reloadable input seed is shifted in one bit at a time or if it happens in parallel.
 - **Parallel output:** This field specifies whether all of the bits in the LFSR chain are connected to the output or just the last register in the chain (serial or parallel).

Other parameters used by this block are explained in the topic [Common Options in Block Parameter Dialog Boxes](#).

Logical

This block is listed in the following Xilinx® Blockset libraries: Basic Elements, Control Logic, Math, and Index.

The Xilinx Logical block performs bitwise logical operations on fixed-point numbers. Operands are zero padded and sign extended as necessary to make binary point positions coincide; then the logical operation is performed and the result is delivered at the output port.

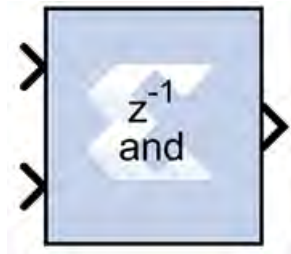

In hardware this block is implemented as synthesizable VHDL. If you build a tree of logical gates, this synthesizable implementation is best as it facilitates logic collapsing in synthesis and mapping.

Block Parameters

The block parameters dialog box can be invoked by double-clicking the icon in your Simulink® model.

- **Basic tab:** Parameters specific to the Basic tab are as follows:
 - **Logical function:** Specifies one of the following bitwise logical operators: AND, NAND, OR, NOR, XOR, XNOR.
 - **Number of inputs:** Specifies the number of inputs (1 - 1024).
 - **Logical Reduction Operation:** When the number of inputs is specified as 1, a unary logical reduction operation performs a bit-wise operation on the single operand to produce a single bit result. The first step of the operation applies the logical operator between the least significant bit of the operand and the next most significant bit. The second and subsequent steps apply the operator between the one-bit result of the prior step and the next bit of the operand using the same logical operator. The logical reduction operator implements the same functionality as that of the logical reduction operation in HDLs. The output of the logical reduction operation is always Boolean.
- **Output Type tab:** Parameters specific to the Output Type tab are as follows.
 - **Align binary point:** Specifies that the block must align binary points automatically. If not selected, all inputs must have the same binary point position.

Other parameters used by this block are explained in the topic [Common Options in Block Parameter Dialog Boxes](#).

MCode

This block is listed in the following Xilinx® Blockset libraries: Control Logic, Math, and Index.

The Xilinx MCode block is a container for executing a user-supplied MATLAB function within Simulink. A parameter on the block specifies the M-function name. The block executes the M-code to calculate block outputs during a Simulink simulation. The same code is translated in a straightforward way into equivalent behavioral VHDL/Verilog when hardware is generated.

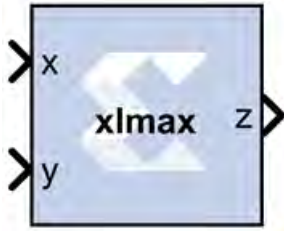

The block's Simulink® interface is derived from the MATLAB function signature, and from block mask parameters. There is one input port for each parameter to the function, and one output port for each value the function returns. Port names and ordering correspond to the names and ordering of parameters and return values.

The MCode block supports a limited subset of the MATLAB language that is useful for implementing arithmetic functions, finite state machines, and control logic.

The MCode block has the following three primary coding guidelines that must be followed:

- All block inputs and outputs must be of Xilinx fixed-point type.
- The block must have at least one output port.
- The code for the block must exist on the MATLAB path or in the same directory as the directory as the model that uses the block.

The example described below consists of a function `xlmax` which returns the maximum of its inputs. The second illustrates how to do simple arithmetic. The third shows how to build a finite state machine.

Configuring an MCode Block

The **MATLAB Function** parameter of an MCode block specifies the name of the block's M-code function. This function must exist in one of the three locations at the time this parameter is set. The three possible locations are:

- The directory where the model file is located.
- A subdirectory of the model directory named `private`.
- A directory in the MATLAB path.

The block icon displays the name of the M-function. To illustrate these ideas, consider the file `xlmax.m` containing function `xlmax`:

```
function z = xlmax(x, y)
    if x > y
        z = x;
    else
        z = y;
    end
```

An MCode block based on the function `xlmax` will have input ports `x` and `y` and output port `z`.

The following figure shows how to set up an MCode block to use function `xlmax`.

Figure 40: xImax function

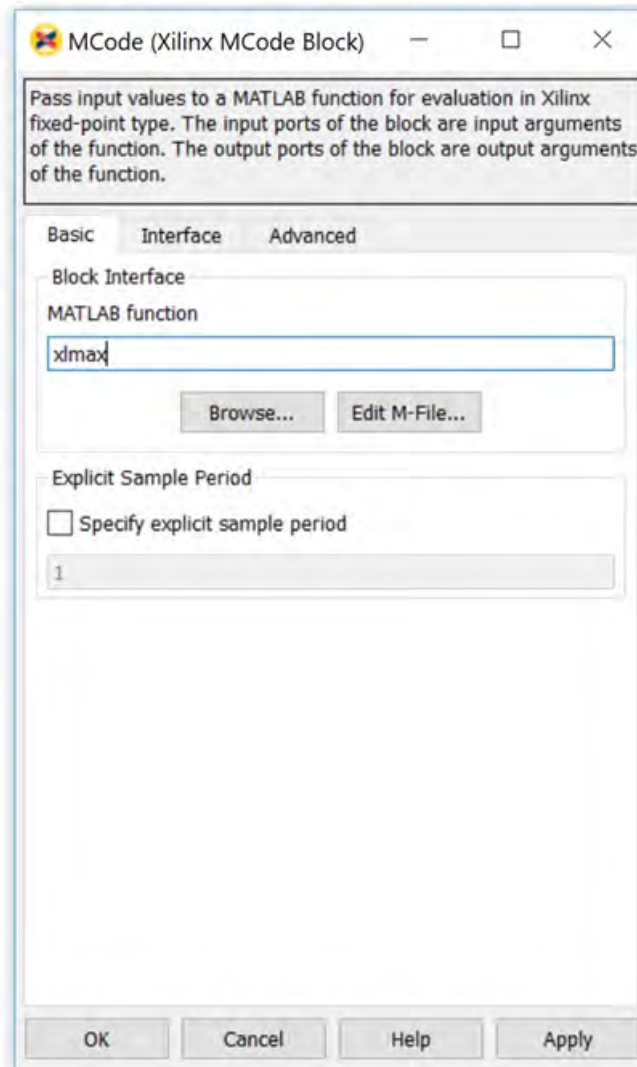

Once the model is compiled, the xImax MCode block will appear like the block illustrated below.

Figure 41: xImax MCode block

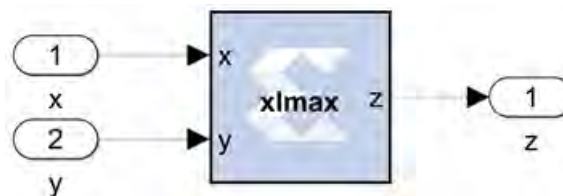

MATLAB Language Support

The MCode block supports the following MATLAB language constructs:

- Assignment statements
- Simple and compound `if/else/elseif` end statements
- `switch` statements
- Arithmetic expressions involving only addition and subtraction
- Addition
- Subtraction
- Multiplication
- Division by a power of two
- Relational operators:

<code><</code>	Less than
<code><=</code>	Less than or equal to
<code>></code>	Greater than
<code>>=</code>	Greater than or equal to
<code>==</code>	Equal to
<code>~=</code>	Not equal to

- Logical operators:

<code>&</code>	And
<code> </code>	Or
<code>~</code>	Not

The MCode block supports the following MATLAB functions.

- Type conversion. The only supported data type is `xfix`, the Xilinx fixed-point type. The `xfix()` type conversion function is used to convert to this type. The conversion is done implicitly for integers but must be done explicitly for floating point constants. All values must be scalar; arrays are not supported.
- Functions that return `xfix` properties:

<code>xl_nbits()</code>	Returns number of bits
<code>xl_binpt()</code>	Returns binary point position
<code>xl_arith()</code>	Returns arithmetic type

- Bit-wise logical functions:

<code>xl_and()</code>	Bit-wise and
<code>xl_or()</code>	Bit-wise or
<code>xl_xor()</code>	Bit-wise xor
<code>xl_not()</code>	Bit-wise not

- Shift functions: `xl_lsh()` and `xl_rsh()`
- Slice function: `xl_slice()`
- Concatenate function: `xl_concat()`
- Reinterpret function: `xl_force()`
- Internal state variables: `xl_state()`
- MATLAB Functions:

<code>disp()</code>	Displays variable values
<code>error()</code>	Displays message and abort function
<code>isnan()</code>	Tests whether a number is NaN
<code>NaN()</code>	Returns Not-a-Number
<code>num2str()</code>	Converts a number to string
<code>ones(1,N)</code>	Returns 1-by-N vector of ones
<code>pi()</code>	Returns pi
<code>zeros(1,N)</code>	Returns 1-by-N vector of zeros

- **Data Types :**

There are three kinds of `xfix` data types: unsigned fixed-point (`xlUnsigned`), signed fixed-point (`xlSigned`), and boolean (`xlBoolean`). Arithmetic operations on these data types produce signed and unsigned fixed-point values. Relational operators produce a boolean result. Relational operands can be any `xfix` type, provided the mixture of types makes sense. Boolean variables can be compared to boolean variables, but not to fixed-point numbers; boolean variables are incompatible with arithmetic operators. Logical operators can only be applied to boolean variables. Every operation is performed in full precision, for example, with the minimum precision needed to guarantee that no information is lost.

Literal Constants

Integer, floating-point, and boolean literals are supported. Integer literals are automatically converted to `xfix` values of appropriate width having a binary point position at zero. Floating-point literals must be converted to the `xfix` type explicitly with the `xfix()` conversion function. The predefined MATLAB values `true` and `false` are automatically converted to boolean literals.

Assignment

The left-hand side of an assignment can only contain one variable. A variable can be assigned more than once.

Control Flow

The conditional expression of an `if` statement must evaluate to a boolean. Switch statements can contain a `case` clause and an `otherwise` clause. The types of a switch selector and its cases must be compatible; thus, the selector can be boolean provided its cases are. All cases in a `switch` must be constant; equivalently, no `case` can depend on an input value.

When the same variable is assigned in several branches of a control statement, the types being assigned must be compatible. For example,

```
if (u > v)
    x = a;
else
    x = b;
end
```

is acceptable only if `a` and `b` are both boolean or both arithmetic.

- **Constant Expressions:**

An expression is constant provided its value does not depend on the value of any input argument. Thus, for example, the variable `c` defined by

```
a = 1;
b = a + 2;
c = xfix({xlSigned, 10, 2}, b + 3.345);
```

can be used in any context that demands a constant.

`xfix()` Conversion

The `xfix()` conversion function converts a `double` to an `xfix`, or changes one `xfix` into another having different characteristics. A call on the conversion function looks like the following

```
x = xfix(type_spec, value)
```

Here `x` is the variable that receives the `xfix`. `type_spec` is a cell array that specifies the type of `xfix` to create, and `value` is the value being operated on. The `value` can be floating point or `xfix` type. The `type_spec` cell array is defined using curly braces in the usual MATLAB method. For example,

```
xfix({xlSigned, 20, 16, xlRound, xlWrap}, 3.1415926)
```

returns an `xfix` approximation to `pi`. The approximation is signed, occupies 20 bits (16 fractional), quantizes by rounding, and wraps on overflow.

The `type_spec` consists of 1, 3, or 5 elements. Some elements can be omitted. When elements are omitted, default element settings are used. The elements specify the following properties (in the order presented): data type, width, binary point position, quantization mode, and overflow mode. The data type can be `xlBoolean`, `xlUnsigned`, or `xlSigned`. When the type is `xlBoolean`, additional elements are not needed (and must not be supplied). For other types, width and binary point position must be supplied. The quantization and overflow modes are optional, but when one is specified, the other must be as well. Three values are possible for quantization: `xlTruncate`, `xlRound`, and `xlRoundBanker`. The default is `xlTruncate`. Similarly, three values are possible for overflow: `xlWrap`, `xlSaturate`, and `xlThrowOverflow`. For `xlThrowOverflow`, if an overflow occurs during simulation, an exception occurs.

All values in a `type_spec` must be known at compilation time; equivalently, no `type_spec` value can depend on an input to the function.

The following is a more elaborate example of an `xfix()` conversion:

```
width = 10, binpt = 4;
z = xfix({xlUnsigned, width, binpt}, x + y);
```

This assignment to `x` is the result of converting `x + y` to an unsigned fixed-point number that is 10 bits wide with 4 fractional bits using `xlTruncate` for quantization and `xlWrap` for overflow.

If several `xfix()` calls need the same `type_spec` value, you can assign the `type_spec` to a variable, then use the variable for `xfix()` calls. For example, the following is allowed:

```
proto = {xlSigned, 10, 4};
x = xfix(proto, a);
y = xfix(proto, b);
```

- **xfix Properties: `xl_arith`, `xl_nbits`, and `xl_binpt`:**

Each `xfix` number has three properties: the arithmetic type, the bit width, and the binary point position. The MCode blocks provide three functions to get these properties of a fixed-point number. The results of these functions are constants and are evaluated when Simulink compiles the model.

Function `a = xl_arith(x)` returns the arithmetic type of the input number `x`. The return value is either 1, 2, or 3 for `xlUnsigned`, `xlSigned`, or `xlBoolean` respectively.

Function `n = xl_nbits(x)` returns the width of the input number `x`.

Function `b = xl_binpt(x)` returns the binary point position of the input number `x`.

- **Bit-wise Operators: `xl_or`, `xl_and`, `xl_xor`, and `xl_not` :**

The MCode block provides four built-in functions for bit-wise logical operations: `x1_or`, `x1_and`, `x1_xor`, and `x1_not`.

Function `x1_or`, `x1_and`, and `x1_xor` perform bit-wise logical or, and, and xor operations respectively. Each function is in the form of

```
x = x1_op(a, b, ).
```

Each function takes at least two fixed-point numbers and returns a fixed-point number. All the input arguments are aligned at the binary point position.

Function `x1_not` performs a bit-wise logical not operation. It is in the form of `x = x1_not(a)`. It only takes one `xfix` number as its input argument and returns a fixed- point number.

The following are some examples of these function calls:

```
X = x1_and(a, b);
Y = x1_or(a, b, c);
Z = x1_xor(a, b, c, d);
N = x1_not(x);
```

- **Shift Operators: `x1_rsh`, and `x1_lsh`:**

Functions `x1_lsh` and `x1_rsh` allow you to shift a sequence of bits of a fixed-point number. The function is in the form:

`x = x1_lsh(a, n)` and `x = x1_rsh(a, n)` where `a` is a `xfix` value and `n` is the number of bits to shift.

Left or right shift the fixed-point number by `n` number of bits. The right shift (`x1_rsh`) moves the fixed-point number toward the least significant bit. The left shift (`x1_lsh`) function moves the fixed-point number toward the most significant bit. Both shift functions are a full precision shift. No bits are discarded and the precision of the output is adjusted as needed to accommodate the shifted position of the binary point.

Here are some examples:

```
% left shift a 5 bits
a = xfix({x1Signed, 20, 16, x1Round, x1Wrap}, 3.1415926)
b = x1_rsh(a, 5);
```

The output `b` is of type `x1Signed` with 21 bits and the binary point located at bit 21.

- **Slice Function: `x1_slice`:**

Function `xl_slice` allows you to access a sequence of bits of a fixed-point number. The function is in the form:

```
x = xl_slice(a, from_bit, to_bit).
```

Each bit of a fixed-point number is consecutively indexed from zero for the LSB up to the MSB. For example, given an 8-bit wide number with binary point position at zero, the LSB is indexed as 0 and the MSB is indexed as 7. The block will throw an error if the `from_bit` or `to_bit` arguments are out of the bit index range of the input number. The result of the function call is an unsigned fixed-point number with zero binary point position.

Here are some examples:

```
% slice 7 bits from bit 10 to bit 4
b = xl_slice(a, 10, 4);
% to get MSB
c = xl_slice(a, xl_nbits(a)-1, xl_nbits(a)-1);
```

- **Concatenate Function: `xl_concat` :**

Function `x = xl_concat(hi, mid, ..., low)` concatenates two or more fixed-point numbers to form a single fixed-point number. The first input argument occupies the most significant bits, and the last input argument occupies the least significant bits. The output is an unsigned fixed-point number with binary point position at zero.

- **Reinterpret Function: `xl_force`:**

Function `x = xl_force(a, arith, binpt)` forces the output to a new type with `arith` as its new arithmetic type and `binpt` as its new binary point position. The `arith` argument can be one of `xlUnsigned`, `xlSigned`, or `xlBoolean`. The `binpt` argument must be from 0 to the bit width inclusively. Otherwise, the block will throw an error.

- **State Variables: `xl_state`:**

An MCode block can have internal state variables that hold their values from one simulation step to the next. A state variable is declared with the MATLAB keyword `persistent` and must be initially assigned with an `xl_state` function call.

The following code models a 4-bit accumulator:

```
function q = accum(din, rst)
    init = 0;

    persistent s, s = xl_state(init, {xlSigned, 4, 0});
    q = s;
```

```

if rst
    s = init;
else
    s = s + din;
end
    
```

The state variable `s` is declared as persistent, and the first assignment to `s` is the result of the `xl_state` invocation. The `xl_state` function takes two arguments. The first is the initial value and must be a constant. The second is the precision of the state variable. It can be a type cell array as described in the `xfix` function call. It can also be an `xfix` number. In the above code, if `s = xl_state(init, din)`, then state variable `s` will use `din` as the precision. The `xl_state` function must be assigned to a persistent variable.

The `xl_state` function behaves in the following way:

1. In the first cycle of simulation, the `xl_state` function initializes the state variable with the specified precision.
2. In the following cycles of simulation, the `xl_state` function retrieves the state value left from the last clock cycle and assigns the value to the corresponding variable with the specified precision.

`v = xl_state(init, precision)` returns the value of a state variable. The first input argument `init` is the initial value, the second argument `precision` is the precision for this state variable. The argument `precision` can be a cell array in the form of `{type, nbits, binpt}` or `{type, nbits, binpt, quantization, overflow}`. The `precision` argument can also be an `xfix` number.

`v = xl_state(init, precision, maxlen)` returns a vector object. The vector is initialized with `init` and will have `maxlen` for the maximum length it can be. The vector is initialized with `init`. For example, `v = xl_state(zeros(1, 8), prec, 8)` creates a vector of 8 zeros, `v = xl_state([], prec, 8)` creates an empty vector with 8 as maximum length, `v = xl_state(0, prec, 8)` creates a vector of one zero as content and with 8 as the maximum length.

Conceptually, a vector state variable is a double ended queue. It has two ends, the front which is the element at address 0 and the back which is the element at length - 1.

Methods available for vector are:

<code>val = v(idx);</code>	Returns the value of element at address <code>idx</code> .
<code>v(idx) = val;</code>	Assigns the element at address <code>idx</code> with <code>val</code> .
<code>f = v.front;</code>	Returns the value of the front end. An error is thrown if the vector is empty.
<code>v.push_front(val);</code>	Pushes <code>val</code> to the front and then increases the vector length by 1. An error is thrown if the vector is full.
<code>v.pop_front;</code>	Pops one element from the front and decreases the vector length by 1. An error is thrown if the vector is empty.
<code>b = v.back;</code>	Returns the value of the back end. An error is thrown if the vector is empty.

<code>v.push_back(val);</code>	Pushes <code>val</code> to the back and the increases the vector length by 1. An error is thrown if the vector is full.
<code>v.pop_back;</code>	Pops one element from the back and decreases the vector length by 1. An error is thrown if the vector is empty.
<code>v.push_front_pop_back(val);</code>	Pushes <code>val</code> to the front and pops one element out from the back. It's a shift operation. The length of the vector is unchanged. The vector cannot be empty to perform this operation.
<code>full = v.full;</code>	Returns <code>true</code> if the vector is full, otherwise, <code>false</code> .
<code>empty = v.empty;</code>	Returns <code>true</code> if the vector is empty, otherwise, <code>false</code> .
<code>len = v.length;</code>	Returns the number of elements in the vector.

A method of a vector that queries a state variable is called a *query method*. It has a return value. The following methods are query method: `v(idx)`, `v.front`, `v.back`, `v.full`, `v.empty`, `v.length`, `v.maxlen`. A method of a vector that changes a state variable is called an *update method*. An update method does not return any value. The following methods are update methods: `v(idx) = val`, `v.push_front(val)`, `v.pop_front`, `v.push_back(val)`, `v.pop_back`, and `v.push_front_pop_back(val)`. All query methods of a vector must be invoked before any update method is invocation during any simulation cycle. An error is thrown during model compilation if this rule is broken.

The MCode block can map a vector state variable into a vector of registers, a delay line, an addressable shift register, a single port ROM, or a single port RAM based on the usage of the state variable. The `x1_state` function can also be used to convert a MATLAB 1-D array into a zero-indexed constant array. If the MCode block cannot map a vector state variable into an FPGA, an error message is issued during model netlist time. The following are examples of using vector state variables.

Delay Line

The state variable in the following function is mapped into a delay line.

```
function q = delay(d, lat)
    persistent r, r = x1_state(zeros(1, lat), d, lat);
    q = r.back;
    r.push_front_pop_back(d);
```

Line of Registers

The state variable in the following function is mapped into a line of registers.

```
function s = sum4(d)
    persistent r, r = x1_state(zeros(1, 4), d);
    S = r(0) + r(1) + r(2) + r(3);
    r.push_front_pop_back(d);
```

Vector of Constants

The state variable in the following function is mapped into a vector of constants.

```
function s = myadd(a, b, c, d, nbits, binpt)
    p = {xlSigned, nbits, binpt, xlRound, xlSaturate};
    persistent coef, coef = xl_state([3, 7, 3.5, 6.7], p);
    s = a*coef(0) + b*coef(1) + c*coef(2) + d*coef(3);
```

Addressable Shift Register

The state variable in the following function is mapped into an addressable shift register.

```
function q = addrshr(d, addr, en, depth)
    persistent r, r = xl_state(zeros(1, depth), d);
    q = r(addr);
    if en
        r.push_front_pop_back(d);
    end
```

Single Port ROM

The state variable in the following function is mapped into a single port ROM.

```
function q = addrshr(contents, addr, arith, nbits, binpt)
    proto = {arith, nbits, binpt};
    persistent mem, mem = xl_state(contents, proto);
    q = mem(addr);
```

- **Single Port RAM:**

The state variable in the following function is mapped to a single port RAM in fabric (Distributed RAM).

```
function dout = ram(addr, we, din, depth, nbits, binpt)
    proto = {xlSigned, nbits, binpt};
    persistent mem, mem = xl_state(zeros(1, depth), proto);
    dout = mem(addr);
    if we
        mem(addr) = din;
    end
```

The state variable in the following function is mapped to BlockRAM as a single port RAM.

```
function dout = ram(addr, we, din, depth, nbits, binpt, ram_enable)
    proto = {xlSigned, nbits, binpt};
    persistent mem, mem = xl_state(zeros(1, depth), proto);
    persistent dout_temp, dout_temp = xl_state(0, proto);
    dout = dout_temp;
```

```
dout_temp = mem(addr);
if we
    mem(addr) = din;
end
```

MATLAB Functions

- **disp()**:

Displays the expression value. In order to see the printing on the MATLAB console, the option **Enable printing with disp** must be checked on the **Advanced** tab of the MCode block parameters dialog box. The argument can be a string, an `xfix` number, or an MCode state variable. If the argument is an `xfix` number, it will print the type, binary value, and double precision value. For example, if variable `x` is assigned with `xfix({xlSigned, 10, 7}, 2.75)`, the `disp(x)` will print the following line:

```
type: Fix_10_7, binary: 010.1100000, double: 2.75
```

If the argument is a vector state variable, `disp()` will print out the type, maximum length, current length, and the binary and double values of all the elements. For each simulation step, when **Enable printing with disp** is on and when a `disp()` function is invoked, a title line is printed for the corresponding block. The title line includes the block name, Simulink simulation time, and FPGA clock number.

The following MCode function shows several examples of using the `disp()` function.

```
function x = testdisp(a, b)
persistent dly, dly = xl_state(zeros(1, 8), a);
persistent rom, rom = xl_state([3, 2, 1, 0], a);
disp('Hello World!');
disp(['num2str(dly) is ', num2str(dly)]);
disp('disp(dly) is ');
disp(dly);
disp('disp(rom) is ');
disp(rom);
a2 = dly.back;
dly.push_front_pop_back(a);
x = a + b;
disp(['a = ', num2str(a), ', ', ', ...
'b = ', num2str(b), ', ', ', ...
'x = ', num2str(x)]);
disp(num2str(true));
disp('disp(10) is');
disp(10);
disp('disp(-10) is');
disp(-10);
disp('disp(a) is ');
disp(a);
disp('disp(a == b)');
disp(a==b);
```

The following lines are the result for the first simulation step.

```
xlmcode_testdisp/MCode (Simulink time: 0.000000, FPGA clock: 0)
Hello World!
num2str(dly) is [0.000000, 0.000000, 0.000000, 0.000000, 0.000000,
0.000000,
0.000000, 0.000000]
disp(dly) is
type: Fix_11_7,
maxlen: 8,
length: 8,
0: binary 0000.0000000, double 0.000000,
1: binary 0000.0000000, double 0.000000,
2: binary 0000.0000000, double 0.000000,
3: binary 0000.0000000, double 0.000000,
4: binary 0000.0000000, double 0.000000,
5: binary 0000.0000000, double 0.000000,
6: binary 0000.0000000, double 0.000000,
7: binary 0000.0000000, double 0.000000,
disp(rom) is
type: Fix_11_7,
maxlen: 4,
length: 4,
0: binary 0011.0000000, double 3.0,
1: binary 0010.0000000, double 2.0,
2: binary 0001.0000000, double 1.0,
3: binary 0000.0000000, double 0.0,
a = 0.000000, b = 0.000000, x = 0.000000
1
disp(10) is
type: UFix_4_0, binary: 1010, double: 10.0
disp(-10) is
type: Fix_5_0, binary: 10110, double: -10.0
disp(a) is
type: Fix_11_7, binary: 0000.0000000, double: 0.000000
disp(a == b)
type: Bool, binary: 1, double: 1
```

- **error() :**

Displays message and abort function. See MATLAB help on this function for more detailed information. Message formatting is not supported by the MCode block. For example:

```
if latency <=0
    error('latency must be a positive');
end
```

- **isnan() :**

Returns true for Not-a-Number. `isnan(X)` returns true when `X` is Not-a-Number. `X` must be a scalar value of double or Xilinx fixed-point number. This function is not supported for vectors or matrices. For example:

```
if isnan(incr) & incr == 1
    cnt = cnt + 1;
end
```

- **NaN() :**

The `NaN()` function generates an IEEE arithmetic representation for Not-a-Number. A NaN is obtained as a result of mathematically undefined operations like `0.0/0.0` and `inf-inf`. `NaN(1,N)` generates a 1-by-N vector of NaN values. Here are examples of using NaN.

```
if x < 0
    z = NaN;
else
    z = x + y;
end
```

- **num2Str() :**

Converts a number to a string. `num2str(X)` converts the `X` into a string. `X` can be a scalar value of double, a Xilinx fixed-point number, or a vector state variable. The default number of digits is based on the magnitude of the elements of `X`. Here's an example of `num2str`:

```
if opcode <= 0 | opcode >= 10
    error(['opcode is out of range: ', num2str(opcode)]);
end
```

- **ones():**

The `ones()` function generates a specified number of one values. `ones(1,N)` generates a 1-by-N vector of ones. `ones(M,N)` where `M` must be 1. It's usually used with `xl_state()` function call. For example, the following line creates a 1-by-4 vector state variable initialized to `[1, 1, 1, 1]`.

```
persistant m, m = xl_state(ones(1, 4), proto)
```

- **zeros() :**

The `zeros()` function generates a specified number of zero values. `zeros(1,N)` generates a 1-by-N vector of zeros. `zeros(M,N)` where `M` must be 1. It's usually used with `xl_state()` function call. For example, the following line creates a 1-by-4 vector state variable initialized to `[0, 0, 0, 0]`.

```
persistant m, m = xl_state(zeros(1, 4), proto)
```

- **FOR Loop:**

FOR statement is fully unrolled. The following function sums n samples.

```
function q = sum(din, n)
    persistent regs, regs = xl_state(zeros(1, 4), din);
    q = reg(0);
    for i = 1:n-1
        q = q + reg(i);
    end
    regs.push_front_pop_back(din);
```

The following function does a bit reverse.

```
function q = bitreverse(d)
    q = xl_slice(d, 0, 0);
    for i = 1:xl_nbits(d)-1
        q = xl_concat(q, xl_slice(d, i, i));
    end
```

- **Variable Availability :**

MATLAB code is sequential (for example, statements are executed in order). The MCode block requires that every possible execution path assigns a value to a variable before it is used (except as a left-hand side of an assignment). When this is the case, we say the variable is *available* for use. The MCode block will throw an error if its M-code function accesses unavailable variables.

Consider the following M-code:

```
function [x, y, z] = test1(a, b)
    x = a;
    if a>b
        x = a + b; y = a;
    end
    switch a
        case 0
            z = a + b;
        case 1
            z = a - b;
    end
```

Here a , b , and x are available, but y and z are not. Variable y is not available because the **if** statement has no **else**, and variable z is not available because the **switch** statement has no **otherwise** part.

DEBUG MCode

There are two ways to debug your MCode. One is to insert `disp()` functions in your code and enable printing; the other is to use the MATLAB debugger. For usage of the `disp()` function, see the `disp()` section in this topic.

If you want to use the MATLAB debugger, you need to check the **Enable MATLAB debugging** option on the **Advanced** tab of the MCode block parameters dialog box. Then you can open your MATLAB function with the MATLAB editor, set break points, and debug your M-function. Just be aware that every time you modify your script, you need to execute a `clear functions` command in the MATLAB console.

To start debugging your M-function, you need to first check the **Enable MATLAB debugging** check box on the **Advanced** tab of the MCode block parameters dialog, then click the **OK** or **Apply** button.

Figure 47: Enable MATLAB Debugging

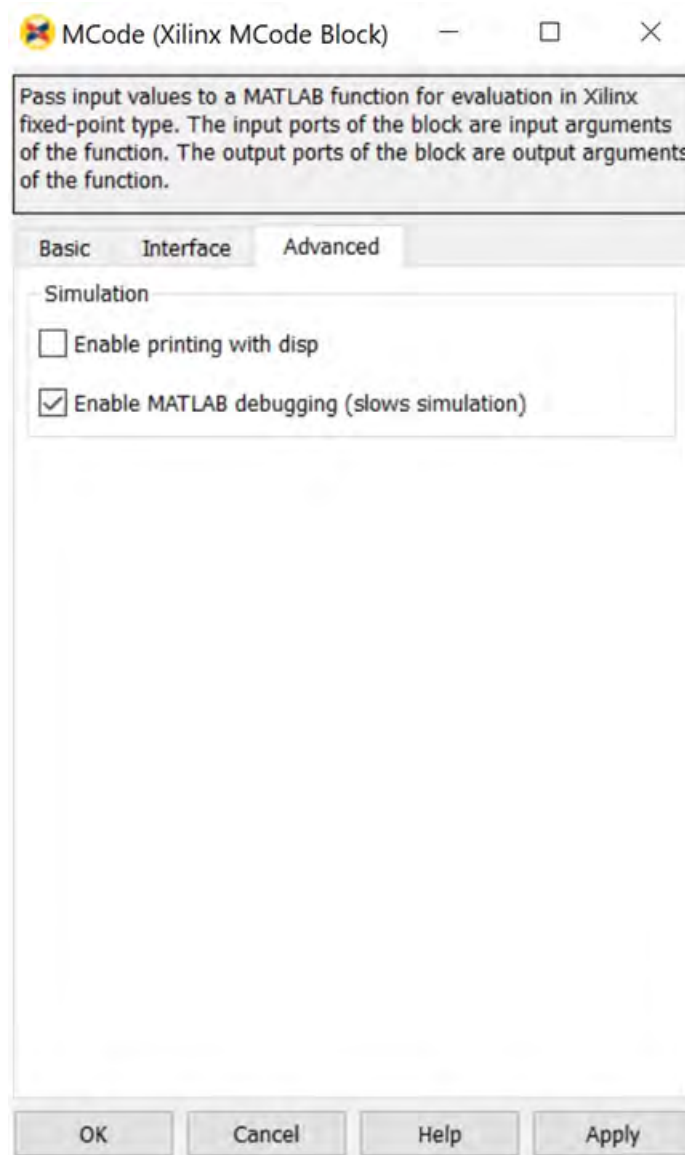

Now you can edit the M-file with the MATLAB editor and set break points as needed.

Figure 48: Set Break Points

```

Editor - C:\Xilinx\Vivado\2018.3\scripts\sysgen\matlab\xlmx.m
xlmx.m x +
1  function z = xlmx(x, y)
2  -     if x > y
3  -         z = x;
4  -     else
5  -         z = y;
6  -     end
7
    
```

During the Simulink simulation, the MATLAB debugger will stop at the break points you set when the break points are reached.

Figure 49: Stopping at Break Point

```

Editor - C:\Xilinx\Vivado\2018.3\scripts\sysgen\matlab\xlmx.m
xlmx.m x +
1  function z = xlmx(x, y)
2  ●→  if x > y
3  -     z = x;
4  -     else
5  -         z = y;
6  -     end
7
    
```

When debugging, you can also examine the values of the variables by typing the variable names in the MATLAB console.

Figure 50: Examining Variable

```

Command Window
File Edit Debug Desktop Window Help
To get started, select MATLAB Help or Demos from the Help menu.
<>> x
Fix(11, 7) : 0.734375
<>> y
Fix(10, 5) : 0.343750
<>> |
    
```

There is one special case to consider when the function for an MCode block is executed from the MATLAB debugger. A `switch/case` expression inside an MCode block must be type `xfix`, however, executing a `switch/case` expression from the MATLAB console requires that the expression be a `double` or `char`. To facilitate execution in the MATLAB console, a call to `double()` must be added. For example, consider the following:

```
switch i
  case 0
    x = 1
  case 1
    x = 2
end
```

where `i` is type `xfix`. To run from the console this code must be changed to

```
switch double(i)
  case 0
    x = 1
  case 1
    x = 2
end
```

The `double()` function call only has an effect when the M code is run from the console. The MCode block ignores the `double()` call.

- **Passing Parameters:**

It is possible to use the same M-function in different MCode blocks, passing different parameters to the M-function so that each block can behave differently. This is achieved by binding input arguments to some values. To bind the input arguments, select the **Interface** tab on the block GUI. After you bind those arguments to some values, these M-function arguments will not be shown as input ports of the MCode block.

Consider for example, the following M-function:

```
function dout = xl_sconvert(din, nbits, binpt)
  proto = {xlSigned, nbits, binpt};
  dout = xfix(proto, din);
```

The following figures shows how the bindings are set for the `din` input of two separate `xl_sconvert` blocks.

Figure 51: din Bindings, Example 1

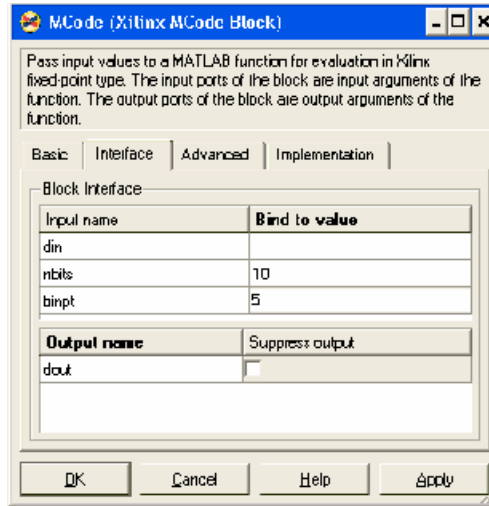
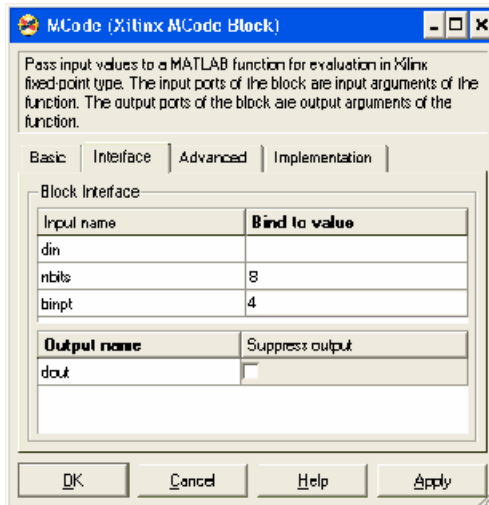
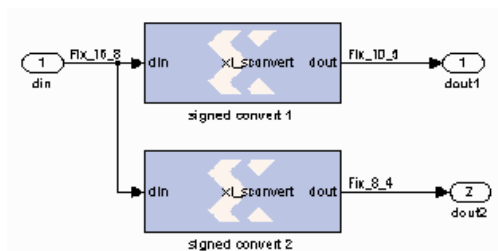

Figure 52: din Bindings, Example 2



The following figure shows the block diagram after the model is compiled.

Figure 53: Block Diagram



The parameters can only be of type double or they can be logical numbers.

- **Optional Input Ports:**

The parameter passing mechanism allows the MCode block to have optional input ports. Consider for example, the following M-function:

```
function s = xl_m_addsub(a, b, sub)
    if sub
        s = a - b;
    else
        s = a + b;
    end
end
```

If `sub` is set to be `false`, the MCode block that uses this M-function will have two input ports `a` and `b` and will perform full precision addition. If it is set to an empty cell array `{}`, the block will have three input ports `a`, `b`, and `sub` and will perform full precision addition or subtraction based on the value of input port `sub`.

The following figure shows the block diagram of two blocks using the same `xl_m_addsub` function, one having two input ports and one having three input ports.

Figure 54: Two Blocks Using Same `xl_m_addsub` Function

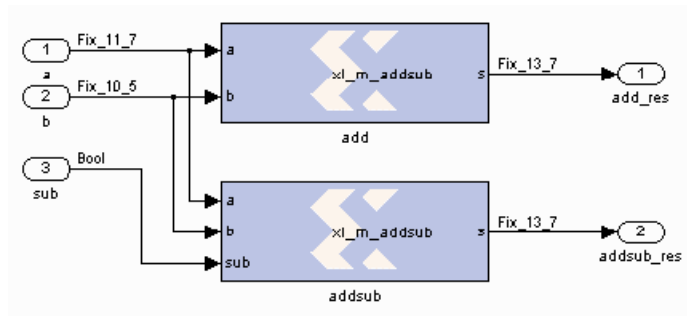

- **Constructing a State Machine:**

There are two ways to build a state machine using an MCode block. One way is to specify a stateless transition function using a MATLAB function and pair an MCode block with one or more state register blocks. Usually the MCode block drives a register with the value representing the next state, and the register feeds back the current state into the MCode block. For this to work, the precision of the state output from the MCode block must be static, that is, independent of any inputs to the block. Occasionally you might find you need to use `xfix()` conversions to force static precision. The following code illustrates this:

```
function nextstate = fsm1(currentstate, din)
    % some other code
    nextstate = currentstate;
    switch currentstate
        case 0, if din==1, nextstate = 1; end
    end
    % a xfix call should be used at the end
    nextstate = xfix({xlUnsigned, 2, 0}, nextstate);
```

Another way is to use state variables. The above function can be re-written as follows:

```
function currentstate = fsm1(din)
    persistent state, state=xl_state(0, {xlUnsigned, 2, 0});
    currentstate = state;
    switch double(state)
        case 0, if din==1; state = 1; end
    end
```

- **Reset and Enable Signals for State Variables:**

The MCode block can automatically infer register reset and enable signals for state variables when conditional assignments to the variables contain two or fewer branches.

For example, the following M-code infers an enable signal for conditional assignment of persistent state variable `r1`:

```
function myFn = aFn(en, a)
    persistent r1, r1 = xl_state(0, {xlUnsigned, 2, 0});
    myFn = r1;
    if en
        r1 = r1 + a
    else
        r1 = r1
    end
```

There are two branches in the conditional assignment to persistent state variable `r1`. A register is used to perform the conditional assignment. The input of the register is connected to `r1 + a`, the output of the register is `r1`. The register's enable signal is inferred; the enable signal is connected to `en`, when `en` is asserted. Persistent state variable `r1` is assigned to `r1 + a` when `en` evaluates to `false`, the enable signal on the register is de-asserted resulting in the assignment of `r1` to `r1`.

The following M-code will also infer an enable signal on the register used to perform the conditional assignment:

```
function myFn = aFn(en, a)
    persistent r1, r1 = x1_state(0, {x1Unsigned, 2, 0});
    myFn = r1;
    if en
        r1 = r1 + a
    end
end
```

An enable is inferred instead of a reset because the conditional assignment of persistent state variable `r1` is to a non-constant value, `r1 + a`.

If there were three branches in the conditional assignment of persistent state variable `r1`, the enable signal would not be inferred. The following M-code illustrates the case where there are three branches in the conditional assignment of persistent state variable `r1` and the enable signal is not inferred:

```
function myFn = aFn(en, en2, a, b)
    persistent r1, r1 = x1_state(0, {x1Unsigned, 2, 0});
    if en
        r1 = r1 + a
    elseif en2
        r1 = r1 + b
    else
        r1 = r1
    end
end
```

The reset signal can be inferred if a persistent state variable is conditionally assigned to a constant; the reset is synchronous. Consider the following M-code example which infers a reset signal for the assignment of persistent state variable `r1` to `init`, a constant, when `rst` evaluates to true and `r1 + 1` otherwise:

```
function myFn = aFn(rst)
    persistent r1, r1 = x1_state(0, {x1Unsigned, 4, 0});
    myFn = r1;
    init = 7;
    if (rst)
        r1 = init
    else
        r1 = r1 + 1
    end
end
```

The M-code example above which infers reset can also be written as:

```
function myFn = aFn(rst)
    persistent r1, r1 = xl_state(0, {xlUnsigned,4,0});
    init = 1;
    myFn = r1;
    r1 = r1 + 1
    if (rst)
        r1 = init
    end
end
```

In both code examples above, the reset signal of the register containing persistent state variable `r1` is assigned to `rst`. When `rst` evaluates to `true`, the register's reset input is asserted and the persistent state variable is assigned to constant `init`. When `rst` evaluates to `false`, the register's reset input is de-asserted and persistent state variable `r1` is assigned to `r1 + 1`. Again, if the conditional assignment of a persistent state variable contains three or more branches, a reset signal is not inferred on the persistent state variable's register.

It is possible to infer reset and enable signals on the register of a single persistent state variable. The following M-code example illustrates simultaneous inference of reset and enable signals for the persistent state variable `r1`:

```
function myFn = aFn(rst,en)
    persistent r1, r1 = xl_state(0, {xlUnsigned, 4, 0});
    myFn = r1;
    init = 0;
    if rst
        r1 = init
    else
        if en
            r1 = r1 + 1
        end
    end
end
```

The reset input for the register of persistent state variable `r1` is connected to `rst`; when `rst` evaluates to `true`, the register's reset input is asserted and `r1` is assigned to `init`. The enable input of the register is connected to `en`; when `en` evaluates to `true`, the register's enable input is asserted and `r1` is assigned to `r1 + 1`. It is important to note that an inferred reset signal takes precedence over an inferred enable signal regardless of the order of the conditional assignment statements. Consider the second code example above; if both `rst` and `en` evaluate to `true`, persistent state variable `r1` would be assigned to `init`.

Inference of reset and enable signals also works for conditional assignment of persistent state variables using switch statements, provided the switch statements contain two or less branches.

The MCode block performs dead code elimination and constant propagation compiler optimizations when generating code for the FPGA. This can result in the inference of reset and/or enable signals in conditional assignment of persistent state variables, when one of the branches is never executed. For this to occur, the conditional must contain two branches that are executed after dead code is eliminated, and constant propagation is performed.

- **Inferring Registers :**

Registers are inferred in hardware by using persistent variables, however, the right coding style must be used. Consider the two code segments in the following function:

```
function [out1, out2] = persistent_test02(in1, in2)
persistent ff1, ff1 = xl_state(0, {xlUnsigned, 2, 0});
persistent ff2, ff2 = xl_state(0, {xlUnsigned, 2, 0});
%code segment 1
out1 = ff1; %these two statements infer a register for ff1
ff1 = in1;
%code segment 2
ff2 = in2; %these two statements do NOT infer a register for ff2
out2 = ff2;
end
```

In code segment 1, the value of persistent variable ff1 is assigned to out1. Since ff1 is persistent, it is assumed that its current value was assigned in the previous cycle. In the next statement, the value of in1 is assigned to ff1 so it can be saved for the next cycle. This infers a register for ff1.

In code segment 2, the value of in2 is first assigned to persistent variable ff2, then assigned to out2. These two statements can be completed in one cycle, so a register is not inferred. If you need to insert delay into combinational logic, refer to the next topic.

- **Pipelining Combinational Logic :**

The generated FPGA bitstream for an MCode block might contain many levels of combinational logic and hence a large critical path delay. To allow a downstream logic synthesis tool to automatically pipeline the combinational logic, you can add delay blocks before the MCode block inputs or after the MCode block outputs. These delay blocks should have the parameter **Implement using behavioral HDL** set, which instructs the code generator to implement delay with synthesizable HDL. You can then instruct the downstream logic synthesis tool to implement register re-timing or register balancing. As an alternative approach, you can use the vector state variables to model delays.

- **Shift Operations with Multiplication and Division:**

The MCode block can detect when a number is multiplied or divided by constants that are powers of two. If detected, the MCode block will perform a shift operation. For example, multiplying by 4 is equivalent to left shifting 2 bits and dividing by 8 is equivalent to right shifting 3 bits. A shift is implemented by adjusting the binary point, expanding the `xfix` container as needed. For example, a `Fix_8_4` number multiplied by 4 will result in a `Fix_8_2` number, and a `Fix_8_4` number multiplied by 64 will result in a `Fix_10_0` number.

- **Using the `xl_state` Function with Rounding Mode:**

The `xl_state` function call creates an `xfix` container for the state variable. The container's precision is specified by the second argument passed to the `xl_state` function call. If precision uses `xlRound` for its rounding mode, hardware resources is added to accomplish the rounding. If rounding the initial value is all that is required, an `xfix` call to round a constant does not require additional hardware resources. The rounded value can then be passed to the `xl_state` function. For example:

```
init = xfix({xlSigned,8,5,xlRound,xlWrap}, 3.14159);
persistent s, s = xl_state(init, {xlSigned, 8, 5});
```

Block Parameters

The block parameters dialog box can be invoked by double-clicking the block icon in a Simulink® model.

Figure 55: Block Parameters

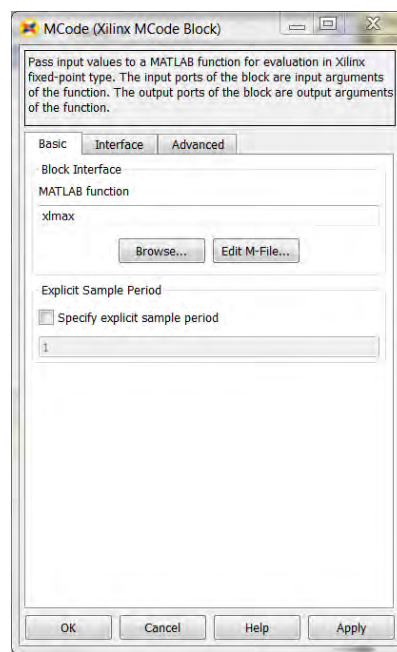

As described earlier in this topic, the **MATLAB function** parameter on an MCode block tells the name of the block's function, and the **Interface** tab specifies a list of constant inputs and their values.

Other parameters used by this block are explained in the topic [Common Options in Block Parameter Dialog Boxes](#).

ModelSim

This block is listed in the following Xilinx® Blockset libraries: Tools and Index.

The System Generator [Black Box](#) block provides a way to incorporate existing HDL files into a model. When the model is simulated, co-simulation can be used to allow black boxes to participate. The ModelSim HDL co-simulation block configures and controls co-simulation for one or several black boxes.



During a simulation, each ModelSim block spawns one copy of ModelSim, and therefore uses one ModelSim license. If licenses are scarce, several black boxes can share the same block.

In detail, the ModelSim block does the following:

- Constructs the additional VHDL and Verilog needed to allow black box HDL to be simulated inside ModelSim.
- Spawns a ModelSim session when a Simulink simulation starts.
- Mediates the communication between Simulink and ModelSim.
- Reports if errors are detected when black box HDL is compiled.
- Terminates ModelSim, if appropriate, when the simulation is complete.

Note: The ModelSim block only supports symbolic radix in the ModelSim tool. In symbolic radix, ModelSim displays the actual values of an enumerated type, and also converts an object's value to an appropriate representation for other radix forms. Please refer to the ModelSim documentation for more information on symbolic radix.

Block Parameters

The block parameters dialog box can be invoked by double-clicking the icon in your Simulink model.

- **Basic tab:** Parameters specific to the Basic tab are as follows.

- **Run co-simulation in directory:**

ModelSim is started in the directory named by this field. The directory is created if necessary. All black box files are copied into this directory, as are the auxiliary files System Generator produces for co-simulation. Existing files are overwritten silently. The directory can be specified as an absolute or relative path. Relative paths are interpreted with respect to the directory in which the Simulink .mdl file resides.

- **Open waveform viewer:**

When this checkbox is selected, the ModelSim waveform window opens automatically, displaying a standard set of signals. The signals include all inputs and outputs of all black boxes and all clock and clock enable signals supplied by System Generator. The signal display can be customized with an auxiliary tcl script. To specify the script, select Add Custom Scripts and enter the script name (e.g., myscript.do) in the Script to Run After vsim field.

- **Leave ModelSim open at end of simulation:**

When this checkbox is selected, the ModelSim session is left open after the Simulink simulation has finished.

- **Skip compilation (use previous results):**

When this checkbox is selected, the ModelSim compilation phase is skipped in its entirety for all black boxes that are using the ModelSim block for HDL co-simulation. To select this option is to assert that: (1) underneath the directory in which ModelSim will run, there exists a ModelSim work directory, and (2) that the work directory contains up-to-date ModelSim compilation results for all black box HDL. Selecting this option can greatly reduce the time required to start-up the simulation, however, if it is selected when inappropriate, the simulation can fail to run or run but produce false results.

- **Advanced tab:** Parameters specific to the Advanced tab are as follows.

- **Include Verilog unisim library:**

Selecting this checkbox ensures that ModelSim includes the Verilog UniSim library during simulation. Note: the Verilog unisim library must be mapped to UNISIMS_VER in ModelSim. In addition, selecting this checkbox ensures the "gbl.v" module is compiled and invoked during simulation.

- **Add custom scripts:**

The term “script” refers to a Tcl macro file (DO file) executed by ModelSim. Selecting this checkbox activates the fields **Script to Run Before Starting Compilation**, **Script to Run in Place of "vsim"**, and **Script to Run after "vsim"**. The DO file scripts named in these fields are not run unless this checkbox is selected.

- **Script to run before starting compilation:**

Enter the name of a Tcl macro file (DO file) that is to be executed by ModelSim before compiling black box HDL files.

Note: For information on how to write a ModelSim macro file (DO file) refer to the **Tcl and macros (DO files)** section in *Model Composer User Guide* ([UG1262](#)).

- **Script to run in place of "vsim":**

ModelSim uses Tcl (tool command language) as the scripting language for controlling and extending the tool. Enter the name of a ModelSim Tcl macro file (DO file) that is to be executed by the ModelSim `do` command at the point when System Generator would ordinarily instruct ModelSim to begin a simulation. To start the simulation after the macro file starts executing, you must place a `vsim` command inside the macro file.

Normally, if this parameter is left blank, or **Add custom scripts** is not selected, then System Generator instructs ModelSim to execute the default command `vsim $toplevel -title {System Generator Co-Simulation (from block $blockname)}` Here `$toplevel` is the name of the top level entity for simulation (e.g., `work.my_model_mti_block`) and `$blockname` is the name of the ModelSim block in the Simulink model associated with the current co-simulation. To avoid problems, certain characters in the block name (e.g., newlines) are sanitized.

If this parameter is not blank and **Add custom scripts** is selected, then System Generator instead instructs ModelSim to execute `do $* $toplevel $blockname`. Here `$toplevel` and `$blockname` are as above and `$*` represents the literal text entered in the field. If, for example the literal text is `'foo.do'`, then ModelSim executes `foo.do`. This macro file can then reference `$toplevel` and `$blockname` as `$1` and `$2`, respectively. Thus, the command `vsim $1` inside of the macro file `foo.do` runs `vsim` on `topLevel`.

- **Script to run after "vsim":**

Enter the name of a Tcl macro file (DO file) that is to be executed by ModelSim after all the HDL for black boxes has been successfully compiled, and after the ModelSim simulation has completed successfully. If the **Open Waveform Viewer** checkbox has been selected, System Generator issues all commands it ordinarily uses to open and customize the waveform viewer before running this script. This allows you to customize the waveform viewer as desired (either by adding signals to the default viewer or by creating a fully custom viewer). The black box tutorial includes an example that customizes the waveform viewer.

It is often convenient to use relative paths in a custom script. Relative paths are interpreted with respect to the directory that contains the model's MDL file. A relative path in the Run co-simulation in directory field is also interpreted with respect to the directory that contains the model's MDL file. Thus, for example, if Run co-Simulation in directory specifies `./modelsim` as the directory in which ModelSim should run, the relative path `../foo.do` in a script definition field refers to a file named `foo.do` in the directory that contains the `.mdl`.

Fine Points

The time scale in ModelSim matches that in Simulink. For example, one second of Simulink simulation time corresponds to one second of ModelSim simulation time. This makes it easy to compare times at which events occur in the two settings. The typically large Simulink time scale is also useful because it allows System Generator to schedule events without running into problems related to the timing characteristics of the HDL model. You need not worry too much about the details of System Generator event scheduling in co-simulation models.

The following example is offered to illustrate the broader points.

Figure 56: Example Model

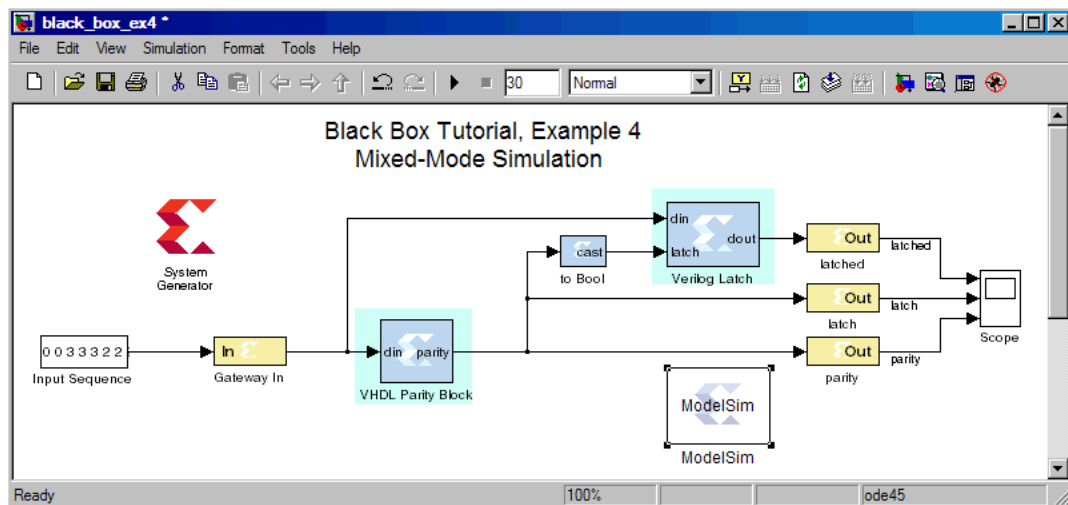

When the above model is run, the following waveforms are displayed by ModelSim:

Figure 57: Example Time Scale

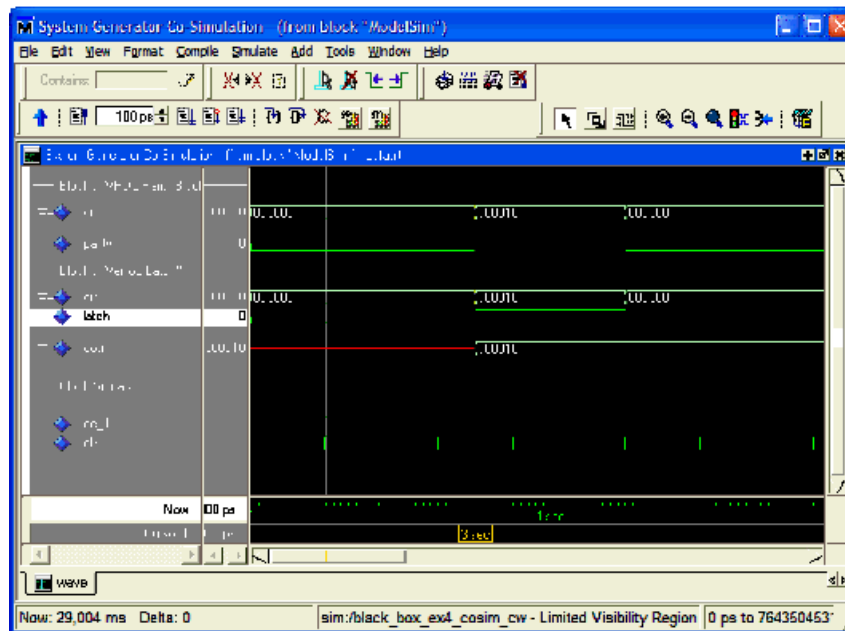

At the time scale presented here (the above shows a time interval of six seconds), the rising clock edge at three seconds and the corresponding transmission of data through each of the two black boxes appear simultaneous, much as they do in the Simulink simulation. Looking at the model, however, it is clear that the output of the first black box feeds the second black box. Both of the black boxes in this model have combinational feed-throughs, for example, changes on inputs translate into immediate changes on outputs. Zooming in toward the three second event reveals how System Generator has resolved the dependencies. Note the displayed time interval has shrunk to ~20 ms.

Figure 58: Resolved Dependencies

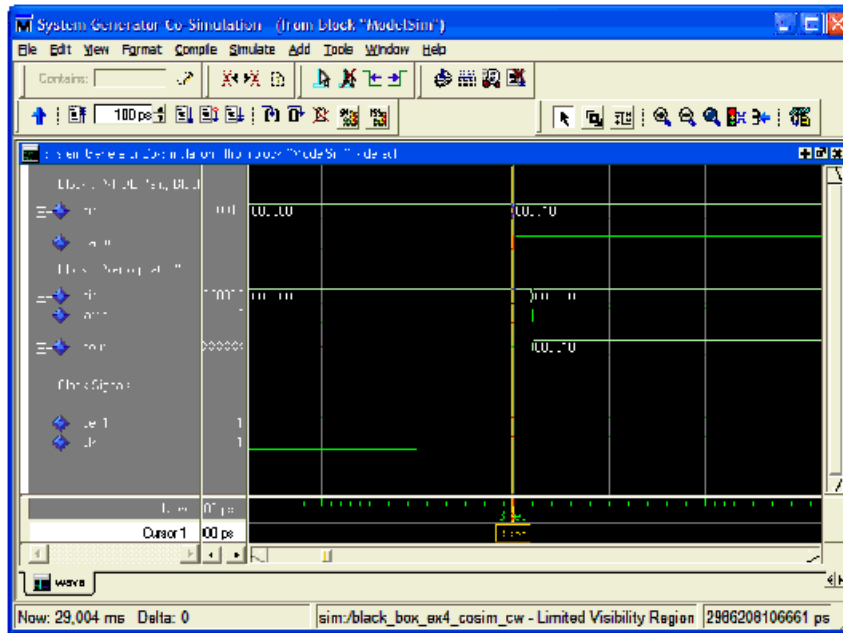

The above figure reveals that System Generator has shifted the rising clock edge so it occurs before the input value is collected from Simulink and presented to the first of the black boxes. It then allows the value to propagate through the first black box and presents the result to the second at a slightly later time. Zooming in still further shows that the HDL model for the first black box includes a propagation delay which System Generator has effectively abstracted away through the use of large time scales. The actual delay through the first black box (exactly 1 ns) can be seen in the figure below.

Figure 59: Delay Through the First Black Box

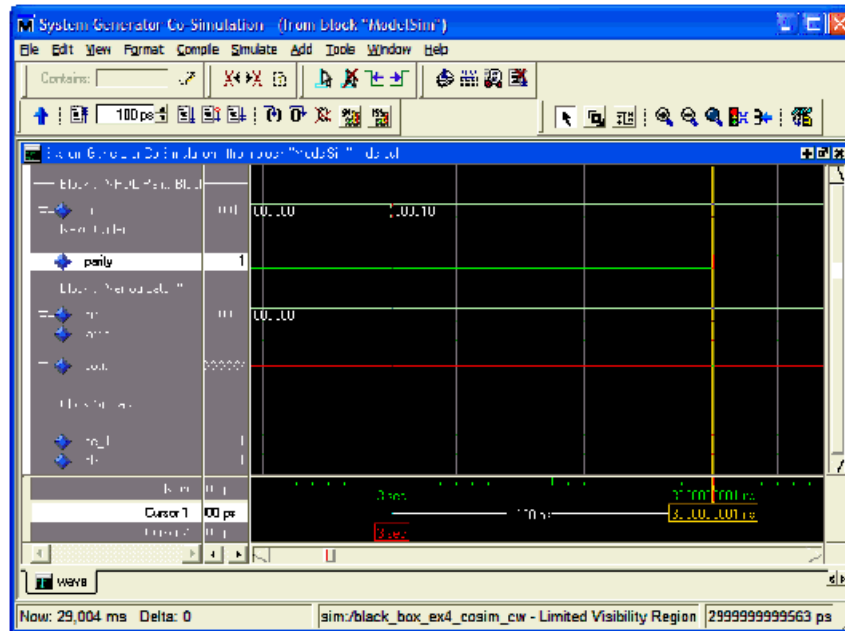

In propagating data through black box components, System Generator allocates 1/ 1000 of the system clock period down to 1us, then shrinks the allocation to 1/100 of the system clock period down to 5 ns, and below that threshold resorts to delta-delay stepping, for example, issuing "run 0 ns" commands to ModelSim. If the HDL includes timing information (e.g., transport delays) and the Simulink System Period is set too low, then the simulation results are incorrect. The above model begins to fail when the Simulink system period setting is reduced below 5e-7, which is the point at which System Generator resorts to delta-delay stepping of the black boxes for data propagation.

Mult

This block is listed in the following Xilinx Blockset libraries: Math, Floating-Point, and Index.

The Xilinx Mult block implements a multiplier. It computes the product of the data on its two input ports, producing the result on its output port.

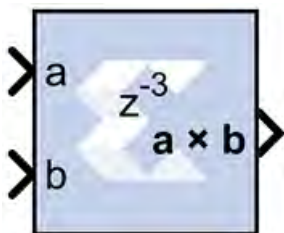

Block Parameters

The block parameters dialog box can be invoked by double-clicking the icon in your Simulink® model.

- **Basic tab:** Parameters specific to the Basic tab are as follows.
 - **Precision:**

This parameter allows you to specify the output precision for fixed-point arithmetic. Floating point output always has **Full** precision.

 - **Full:** The block uses sufficient precision to represent the result without error.
 - **User Defined:** If you do not need full precision, this option allows you to specify a reduced number of total bits and/or fractional bits.
 - **Fixed-point output type:**
 - **Arithmetic Type:**
 - **Signed (2's comp):** The output is a Signed (2's complement) number.
 - **Unsigned:** The output is an Unsigned number.
 - **Number of bits:** Specifies the bit location of the binary point of the output number, where bit zero is the least significant bit.
 - **Binary point:** Position of the binary point in the fixed-point output.
 - **Quantization:**

Refer to the Overflow and Quantization section in the [Common Options in Block Parameter Dialog Boxes](#) topic.
 - **Overflow:**

Refer to the Overflow and Quantization section in the [Common Options in Block Parameter Dialog Boxes](#) topic.
 - **Optional Port:** Provide enable port
 - **Latency:** This defines the number of sample periods by which the block's output is delayed.

Note: Only when latency of the Mult block is set to 4 in System Generator, are all three pipeline stages used in the generated Multiplier IP.
- **Implementation tab:** Parameters specific to the Implementation tab are as follows.
 - **Use behavioral HDL (otherwise use core):**

The block is implemented using behavioral HDL. This gives the downstream logic synthesis tool maximum freedom to optimize for performance or area.

Note: For Floating-point operations, the block always uses the Floating-point Operator core.

- **Core Parameters:**
 - **Optimize for Speed|Area:** Directs the block to be optimized for either Speed or Area.
 - **Use embedded multipliers:** This field specifies that if possible, use the XtremeDSP slice (DSP48 type embedded multiplier) in the target device.
 - **Test for optimum pipelining:** Checks if the Latency provided is at least equal to the optimum pipeline length. Latency values that pass this test imply that the core produced is optimized for speed.

Other parameters used by this block are explained in the topic [Common Options in Block Parameter Dialog Boxes](#).

LogiCORE™ Documentation

[LogiCORE IP Multiplier v12.0](#)

[LogiCORE IP Floating-Point Operator v7.1](#)

MultAdd

This block is listed in the following Xilinx® Blockset libraries: Floating-Point, Math, and Index.

The Xilinx MultAdd block performs both fixed-point and floating-point multiply and addition with the a and b inputs used for the multiplication and the c input for addition or subtraction.

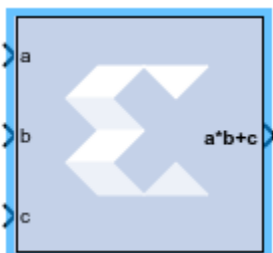

If the MultAdd inputs are floating point, then inputs a,b, and c must be of the same data type. If the inputs are fixed point, then the port c binary point must be aligned to the sum of the port a and port b binary points.

Block Parameters

The block parameters dialog box can be invoked by double-clicking the icon in your Simulink® model.

- **Basic tab:** Parameters specific to the Basic tab are as follows.
 - **Operation:**
 - **Addition:** Specifies that an addition will be performed after multiplication.
 - **Subtraction:** Specifies that a subtraction will be performed after multiplication.
 - **Addition or subtraction:** Adds a **subtract** port to the block, which controls whether the operation following multiplication is addition or subtraction (**subtract High** = subtraction, **subtract Low** = addition).
 - **Optional Ports:**
 - **Provide enable port:** Adds an active-High enable port to the block interface.
 - **Latency:**
 - **Latency:**

This defines the number of sample periods by which the block's output is delayed. The latency values you can set depend on whether you are performing fixed point or floating point arithmetic:

- For fixed point arithmetic, you can only specify a latency of **0** (for no latency) or **-1** (for maximum/optimal latency). If you have added an enable port to the block interface, you can only specify a latency of **-1** for fixed point arithmetic.
- For floating point arithmetic, you can only specify a latency of **0** (for no latency) or a positive integer. If you have added an enable port to the block interface, you can only specify a positive integer for floating point arithmetic.

See the [LogiCORE IP Multiply Adder v3.0 Product Guide](#) for details on latency in the block.

- **Output tab:**

Parameters specific to the Output tab are as follows.

- **Precision:** This parameter allows you to specify the output precision for fixed-point arithmetic. Floating point arithmetic output will always be **Full** precision.
 - **Full:** The block uses sufficient precision to represent the result without error.
 - **User Defined:** If you do not need full precision, this option allows you to specify a reduced number of total bits and/or fractional bits.

- **Fixed-point Output Type:** Arithmetic type
 - **Signed (2's comp):** The output is a Signed (2's complement) number.
 - **Unsigned:** The output is an Unsigned number.

Other parameters used by this block are explained in the topic [Common Options in Block Parameter Dialog Boxes](#).

LogiCORE Documentation

[LogiCORE IP Multiply Adder v3.0](#)

[LogiCORE IP Floating-Point Operator v7.1](#)

Mux

This block is listed in the following Xilinx® Blockset libraries: Basic Elements, Control Logic, Floating-Point, and Index.

The Xilinx Mux block implements a multiplexer. The block has one select input (type unsigned) and a user-configurable number of data bus inputs, ranging from 2 to 32.

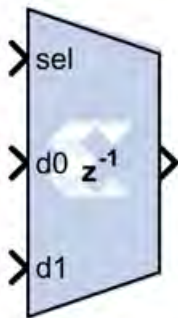

Block Parameters

The block parameters dialog box can be invoked by double-clicking the icon in your Simulink® model.

- **Basic tab:**
 - **Number of inputs:** specify a number between 2 and 32.
 - **Optional Ports:** Other parameters used by this block are explained in the topic [Common Options in Block Parameter Dialog Boxes](#).

- **Output tab:**
 - **Precision:** This parameter allows you to specify the output precision for fixed-point arithmetic. Floating point arithmetic output will always be **Full** precision.
 - **Full:** The block uses sufficient precision to represent the result without error.
 - **User Defined:** If you do not need full precision, this option allows you to specify a reduced number of total bits and/or fractional bits.
 - **Fixed-point output type:**
 - **Arithmetic type:**
 - **Signed (2's comp):** The output is a Signed (2's complement) number.
 - **Unsigned:** The output is an Unsigned number.
 - **Number of bits:** Specifies the bit location of the binary point of the output number where bit zero is the least significant bit.
 - **Binary point:** Position of the binary point. in the fixed-point output.
 - **Quantization:**

Refer to the section Overflow and Quantization in the topic [Common Options in Block Parameter Dialog Boxes](#).
 - **Overflow:**

Refer to the section Overflow and Quantization in the topic [Common Options in Block Parameter Dialog Boxes](#).

Parameters used by this block are explained in the topic [Common Options in Block Parameter Dialog Boxes](#).

LogiCORE Documentation

[LogiCORE IP Floating-Point Operator v7.1](#)

Natural Logarithm

This block is listed in the following Xilinx Blockset libraries: Floating-Point, Index, and Math.

The Xilinx Natural Logarithm block produces the natural logarithm of the input.

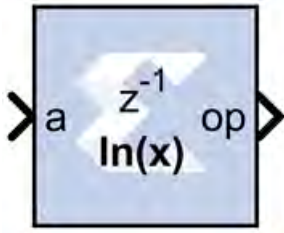

Block Parameters Dialog Box

- **Basic tab:** Parameters specific to the Basic tab are as follows.
 - **Flow Control Options:**
 - **Blocking:** In this mode, the block waits for data on the input, as indicated by TREADY, which allows back-pressure.
 - **NonBlocking:** In this mode, the block operates every cycle in which the input is valid, no back-pressure.
- **Optional Ports tab:**

Parameters specific to the Basic tab are as follows.

- **Input Channel Ports:**
 - **Has TLAST:** Adds a tlast input port to the block.
 - **Has TUSER:** Adds a tuser input port to the block.
- **Control Options:**
 - **Provide enable port:** Adds an enable port to the block interface.
 - **Has Result TREADY:** Adds a TREADY port to the output channel.
- **Exception Signals::**
 - **INVALID_OP:** Adds an output port that serves as an invalid operation flag.
 - **DIVIDE_BY_ZERO:** Adds an output port that serves as a divide-by-zero flag.

LogiCORE Documentation

[LogiCORE IP Floating-Point Operator v7.1](#)

Negate

This block is listed in the following Xilinx Blockset libraries: Floating-Point, Math and Index.

The Xilinx Negate block computes the arithmetic negation of its input.

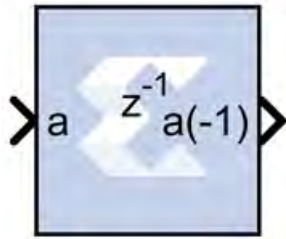

Block Parameters

The block parameters dialog box can be invoked by double-clicking the icon in your Simulink® model.

- **Basic tab:** Parameters specific to the Basic tab are as follows.
 - **Precision:** This parameter allows you to specify the output precision for fixed-point arithmetic. Floating point output always has **Full** precision.
 - **Full:** The block uses sufficient precision to represent the result without error.
 - **User Defined:** If you do not need full precision, this option allows you to specify a reduced number of total bits and/or fractional bits.
 - **Fixed-Point Output Type:**
 - Arithmetic Type
 - **Signed (2's comp):** The output is a Signed (2's complement) number.
 - **Unsigned:** The output is an Unsigned number.
 - **Fixed-point Precision:**
 - **Number of bits:** Specifies the bit location of the binary point of the output number, where bit zero is the least significant bit.
 - **Binary point:** Position of the binary point in the fixed-point output.
 - **Quantization:** Refer to the section Overflow and Quantization in the topic [Common Options in Block Parameter Dialog Boxes](#).
 - **Overflow:** Refer to the section Overflow and Quantization in the topic [Common Options in Block Parameter Dialog Boxes](#).

- **Optional Port:** Provide enable port
- **Latency:** This defines the number of sample periods by which the block's output is delayed.

Parameters used by this block are explained in the topic [Common Options in Block Parameter Dialog Boxes](#).

Opmode

This block is listed in the following Xilinx® Blockset libraries: DSP and Index.

The Xilinx Opmode block generates a constant that is a DSP48E, DSP48E1, or DSP48E2 instruction. It is a 15-bit instruction for DSP48E, a 20-bit instruction for DSP48E1, and a 22-bit instruction for DSP48E2. The instruction consists of the opmode, carry-in, carry-in select, alumode, and (for DSP48E1 and DSP48E2) the inmode bits.

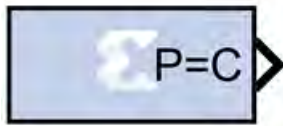

The Opmode block is useful for generating DSP48E, DSP48E1, or DSP48E2 control sequences. The figure below shows an example. The example implements a 35x35-bit multiplier using a sequence of four instructions in a DSP48E block. The Opmode blocks supply the desired instructions to a multiplexer that selects each instruction in the desired sequence.

Figure 60: DSP48E Block

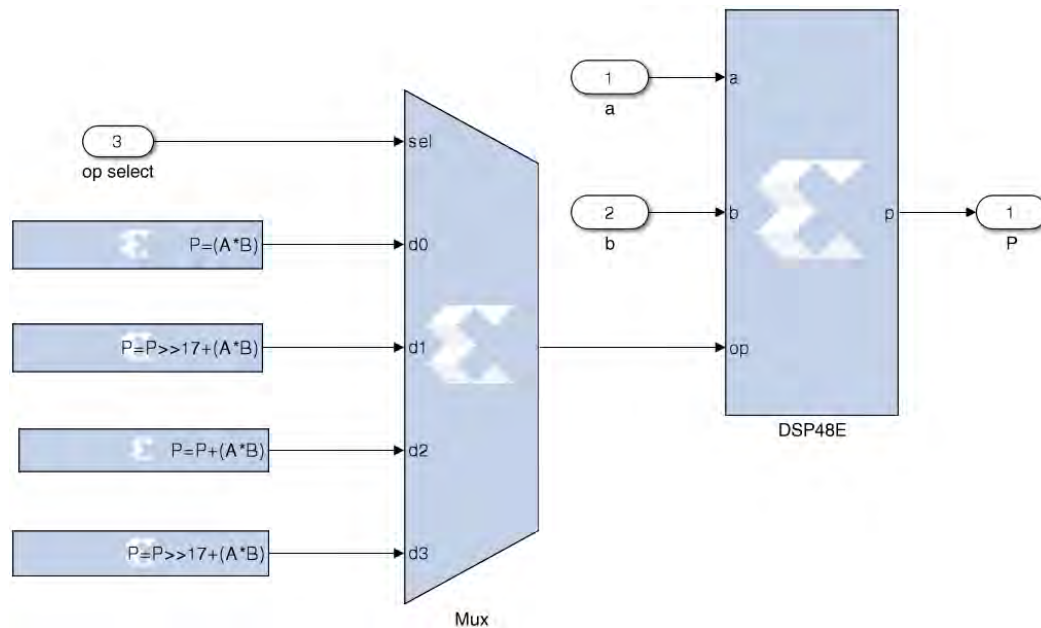

Block Parameters

The block parameters dialog box can be invoked by double-clicking the icon in your Simulink® model.

- **Opmode tab:**

Parameters specific to the Opmode tab are as follows.

- **Instruction:**

- **Device:** Specifies whether to generate an instruction for the DSP48E, DSP48E1, or DSP48E2 device.

- **DSP Instruction:**

- **Operation:** Displays the instruction that is generated by the block. This instruction is also displayed on the block in the Simulink model.
- **Operation select:** Selects the instruction.
- **Preadder output:** Allows you to select the equation for the DSP48E1 Preadder.

- **DSP Primitive Configuration:**

- **Multiplier Output:** Allows you to select the Multiplier Output of DSP58 to be normal or negated.

- **Padder/Mult Function:** Allows you to select the function performed by the DSP48E2 Padder/Multiplier.
- **PREADDINSEL:** Displays the setting of the PREADDINSEL static control bits that are part of the instruction generated by the Opmode block. In the DSP48E2 slice, the PREADDINSEL setting (A or B) selects the input to be added with the D input in the pre-adder.
- **AMULTSEL:** Displays the setting of the AMULTSEL static control bits that are part of the instruction generated by the Opmode block. In the DSP48E2 slice, the AMULTSEL setting (A or AD) selects the input to the 27-bit A input of the multiplier.
- **BMULTSEL:** Displays the setting of the BMULTSEL static control bits that are part of the instruction generated by the Opmode block. In the DSP48E2 slice, the BMULTSEL setting (B or AD) selects the input to the 18-bit B input of the multiplier.
- **A register configuration:** Allows you to select the A register configuration for the DSP48E2. Select either A1 or A2.
- **B register configuration:** Allows you to select the B register configuration for the DSP48E1 or DSP48E2. Select either B1 or B2.
- **Custom Instruction:**

Note: The Custom Instruction field is activated when you select “Custom” in the **Operation select** field.

- **Instruction:** Allows you to select the instruction for the DSP48E, DSP48E1, or DSP48E2.
- **Z mux:** Specifies the 'Z' source to the add/sub/logic unit to be one of {'0', 'C', 'PCIN', 'P', 'C', 'PCIN>>17', 'P>>17'}.
- **XY muxes:** Specifies the 'XY' source to the DSP48's adder to be one of {'0', 'P', 'A:B', 'A*B', 'C', 'P+C', 'A:B+C'}. 'A:B' implies that A is concatenated with B to produce a value to be used as an input to the add/sub/logic unit.
- **W mux:** Specifies the 'W' source to the DSP48E2's adder to be one of {'0', 'P', 'RND', 'C'}.
- **Carry input:** Specifies the 'carry' source to the DSP48's add/sub/logic unit to be one of {'0', '1', 'CIN', 'Round PCIN towards infinity', 'Round PCIN towards zero', 'Round P towards infinity', 'Round P towards zero', 'Larger add/sub/acc (parallel operation)', 'Larger add/sub/acc (sequential operation)', 'Round A*B'}.

For a description of any of the Custom Instruction options, see the following manuals:

- DSP48E: Virtex-5 FPGA XtremeDSP Design Considerations ([UG193](#))
- DSP48E1: 7 Series DSP48E1 Slice User Guide ([UG479](#))

- DSP48E2: UltraScale Architecture DSP Slice User Guide ([UG579](#))

Xilinx LogiCORE

The Opmode block does not use a Xilinx LogiCORE.

DSP48E Control Instruction Format

DSP48E Instruction

Operation select	Notes
C + A*B	
PCIN + A*B	
P + A*B	
A* B	
C + A:B	
C - A:B	
C	
Custom	Use equation described in the Custom Instruction Field.

DSP48E Custom Instruction

Instruction Field Name	Location	Mnemonic	Notes
XY muxes	op[3:0]	0	0
		P	DSP48 output register
		A:B	Concat inputs A and B (A is MSB)
		A*B	Multiplication of inputs A and B
		C	DSP48 input C
		P+C	DSP48 input C plus P
		A:B+C	Concat inputs A and B plus C register
Z mux	op[6:4]	0	0
		PCIN	DSP48 cascaded input from PCOUT
		P	DSP48 output register
		C	DSP48 C input
		PCIN>>17	Cascaded input downshifted by 17
		P>>17	DSP48 output register downshifted by 17
Alumode	op[10:7]	X+Z	Add
		Z-X	Subtract

Instruction Field Name	Location	Mnemonic	Notes
Carry input	op[14:12]	0 or 1	Set carry in to 0 or 1
		CIN	Select cin as source. This adds a CIN port to the Opmode block whose value is inserted into the mnemonic at bit location 11.
		Round PCIN toward infinity	
		Round PCIN toward zero	
		Round P toward infinity	
		Round P toward zero	
		Larger add/sub/acc (parallel operation)	
		Larger add/sub/acc (sequential operation)	
		Round A*B	

DSP48E1 Control Instruction Format

DSP48E1 Instruction

Operation select	Notes
$C + A*B$	
$PCIN + A*B$	
$P + A*B$	
$A* B$	
$C + A:B$	
$C - A:B$	
C	
Custom	Use equation described in the Custom Instruction Field.

Preadder output	Notes
Zero	
A2	
A1	
$D + A2$	
$D + A1$	
D	
-A2	
-A1	
$D - A2$	
$D - A1$	

B register configuration	Notes
B1	
B2	

DSP48E1 Custom Instruction

Instruction Field Name	Location	Mnemonic	Notes
Instruction		X + Z	
		X +NOT(Z)	
		NOT(X+Z)	
		Z - X	
		X XOR Z	
		X XNOR Z	
		X AND Z	
		X OR Z	
		X AND NOT(Z)	
		X OR NOT (Z)	
		X NAND Z	
Z mux	op[6:4]	0	0
		PCIN	DSP48 cascaded input from PCOUT
		P	DSP48 output register
		C	DSP48 C input
		PCIN>>17	Cascaded input downshifted by 17
		P>>17	DSP48 output register downshifted by 17
Operand: (Alumode)	op[10:7]	X+Z	Add
		Z-X	Subtract
XY muxes	op[3:0]	0	0
		P	DSP48 output register
		A:B	Concat inputs A and B (A is MSB)
		A*B	Multiplication of inputs A and B
		C	DSP48 input C
		P+C	DSP48 input C plus P
		A:B+C	Concat inputs A and B plus C register

Instruction Field Name	Location	Mnemonic	Notes
Carry input	op[14:12]	0 or 1	Set carry in to 0 or 1
		CIN	Select cin as source. This adds a CIN port to the Opmode block whose value is inserted into the mnemonic at bit location 11.
		Round PCIN toward infinity	
		Round PCIN toward zero	
		Round P toward infinity	
		Round P toward zero	
		Larger add/sub/acc (parallel operation)	
		Larger add/sub/acc (sequential operation)	
		Round A*B	

DSP48E2 Control Instruction Format

DSP48E2 Instruction

Operation select	Notes
$C + A*B$	
$PCIN + A*B$	
$P + A*B$	
$A* B$	
$C + A:B$	
$C - A:B$	
C	
Custom	Use equation described in the Custom Instruction Field.

Preadder/Mult Function	Notes
Zero	
$A*B$	
$(D+A)*B$	
$(D-A)*B$	
$(D+A)**2$	
$(D-A)**2$	
$D**2$	
$A**2$	
$-(A**2)$	
$(D+A)*A$	
$(D-A)*A$	
$(D+B)*A$	

Preadder/Mult Function	Notes
$(D-B)*A$	
$D*A$	
$B*A$	
$-B*A$	
$(D+B)**2$	
$(D-B)**2$	
$B**2$	
$-(B**2)$	
$(D+B)*B$	
$(D-B)*B$	

A register configuration	Notes
A1	
A2	

B register configuration	Notes
B1	
B2	

DSP48E2 Custom Instruction

Instruction Field Name	Location	Mnemonic	Notes
XY muxes	op[3:0]	0	0
		P	DSP48 output register
		A:B	Concat inputs A and B (A is MSB)
		A*B	Multiplication of inputs A and B
		C	DSP48 input C
		P+C	DSP48 input C plus P
		A:B+C	Concat inputs A and B plus C register
Z mux	op[6:4]	0	0
		PCIN	DSP48 cascaded input from PCOUT
		P	DSP48 output register
		C	DSP48 C input
		PCIN>>17	Cascaded input downshifted by 17
		P>>17	DSP48 output register downshifted by 17

Instruction Field Name	Location	Mnemonic	Notes
W mux	op[8:7]	0	
		P	DSP48 output register
		RND	Rounding Constant into W mux
		C	DSP48 input C
ALU mode (Instruction)	op[12:9]	X + W + Z	
		X +W + NOT(Z)	
		NOT(X + W + Z)	
		Z - (X+W)	
		X XOR Z	
		X XNOR Z	
		X AND Z	
		X OR Z	
		X AND NOT(Z)	
		X OR NOT (Z)	
		X NAND Z	
		X NOR Z	
		NOT (X) OR Z	
		NOT (X) AND Z	
Carry input	op[16:13]	0 or 1	Set carry in to 0 or 1
		CIN	Select CIN as source. This adds a CIN port to the Opmode block whose value is inserted into the mnemonic at bit location 11.
		Round PCIN toward infinity	
		Round PCIN toward zero	
		Round P toward infinity	
		Round P toward zero	
		Larger add/sub/acc (parallel operation)	
		Larger add/sub/acc (sequential operation)	
		Round A*B	

Instruction Field Name	Location	Mnemonic	Notes
Pre-Adder/Mult Function	op[21:17]	Zero	
		$A * B$	
		$(D + A) * B$	
		$(D - A) * B$	
		$(D + A)**2$	
		$(D - A)**2$	
		$D**2$	
		$A**2$	
		$-(A**2)$	
		$(D + A) * A$	
		$(D - A) * A$	
		$(D + B) * A$	
		$(D - B) * A$	
		$D * A$	
		$B * A$	
		$-B * A$	
		$(D + B)**2$	
		$(D - B)**2$	
		$B**2$	
		$-(B**2)$	
$(D + B) * B$			
$(D - B) * B$			

DSPCPLX Control Instruction Format

The OpMode block, when configured with a DSPCPLX device, outputs 18-bit wide data to drive the consolidated control port of the DSPCPLX block. The DSPCPLX block internally feeds the same setting to respective individual Real and Imaginary control input ports.

Table 18: DSPCPLX Instruction

Operation Select	Notes
A*B	
Custom	Use the equation described in the Custom Instruction Field.

Table 19: DSPCPLX Custom Instruction

Instruction Field Name	Location	Mnemonic	Notes
XY Muxes	op[3:0]	A*B	Multiplication of inputs A and B

Table 19: DSPCPLX Custom Instruction (cont'd)

Instruction Field Name	Location	Mnemonic	Notes
Z mux	op[6:4]	0	0
		PCIN	DSPCPLX cascaded input from PCOUT
		P	DSPCPLX output register
		C	DSPCPLX C input
W mux	op[8:7]	0	
		RND	Rounding constant into W mux
ALU mode (Instruction)	op[12:9]	X + W + Z	
Carry input	op[16:13]	0 or 1	Set carry in to 0 or 1
		CIN	Select CIN as source. This adds a CIN port to the Opmode block whose value is inserted into the mnemonic at bit location 11.
Conjugate A Input	op[17]	0 or 1	Select to complex conjugate the input A value
Conjugate B Input	op[18]	0 or 1	Select to complex conjugate the input B value

DSP58 Control Instruction Format

DSP58 Instruction

Operation select	Notes
C + A*B	
PCIN + A*B	
P + A*B	
A* B	
C + A:B	
C - A:B	
C	
Custom	Use equation described in the Custom Instruction Field.

Preadder/Mult Function	Notes
Zero	
$\pm A*B$	
$\pm(D\pm A)*B$	
$\pm(D\pm A)**2$	
$\pm(D)**2$	
$\pm(A)**2$	
$\pm(D\pm A)*A$	
$\pm(D\pm B)*A$	
$\pm D*A$	

Preadder/Mult Function	Notes
$\pm(D\pm B)**2$	
$\pm(B)**2$	
$\pm(D\pm B)*B$	

A register configuration	Notes
A1	
A2	

B register configuration	Notes
B1	
B2	

DSP58 Custom Instruction

Instruction Field Name	Location	Mnemonic	Notes
XY muxes	op[3:0]	0	0
		P	DSP58 output register
		A:B	Concat inputs A and B (A is MSB)
		A*B	Multiplication of inputs A and B
		C	DSP58 input C
		P+C	DSP58 input C plus P
		A:B+C	Concat inputs A and B plus C register
Z mux	op[6:4]	0	0
		PCIN	DSP58 cascaded input from PCOUT
		P	DSP58 output register
		C	DSP58 C input
		PCIN>>17	Cascaded input downshifted by 17
		P>>17	DSP58 output register downshifted by 17
W mux	op[8:7]	0	
		P	DSP58 output register
		RND	Rounding Constant into W mux
		C	DSP58 input C

Instruction Field Name	Location	Mnemonic	Notes
ALU mode (Instruction)	op[12:9]	X + W + Z	
		X +W + NOT(Z)	
		NOT(X + W + Z)	
		Z - (X+W)	
		X XOR Z	
		X XNOR Z	
		X AND Z	
		X OR Z	
		X AND NOT(Z)	
		X OR NOT (Z)	
		X NAND Z	
		X NOR Z	
		NOT (X) OR Z	
		NOT (X) AND Z	
Carry input	op[16:13]	0 or 1	Set carry in to 0 or 1
		CIN	Select CIN as source. This adds a CIN port to the Opmode block whose value is inserted into the mnemonic at bit location 11.
		Round PCIN toward infinity	
		Round PCIN toward zero	
		Round P toward infinity	
		Round P toward zero	
		Larger add/sub/acc (parallel operation)	
		Larger add/sub/acc (sequential operation)	
Pre-Adder/Mult Function	op[21:17]	Zero	
		$\pm A * B$	
		$\pm (D \pm A) * B$	
		$\pm (D \pm A) ** 2$	
		$\pm (D) ** 2$	
		$\pm (A) ** 2$	
		$\pm (D \pm A) * A$	
		$\pm (D \pm B) * A$	
		$\pm D * A$	
		$\pm (D \pm B) ** 2$	
		$\pm (B) ** 2$	
		$\pm (D \pm B) * B$	
		Negate	op[24:22]

Parallel to Serial

This block is listed in the following Xilinx® Blockset libraries: Basic Elements, Data Types, and Index.

The Parallel to Serial block takes an input word and splits it into N time-multiplexed output words where N is the ratio of number of input bits to output bits. The order of the output can be either least significant bit first or most significant bit first.

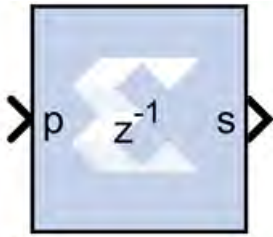

The following waveform illustrates the block's behavior:

Figure 61: Block Behavior

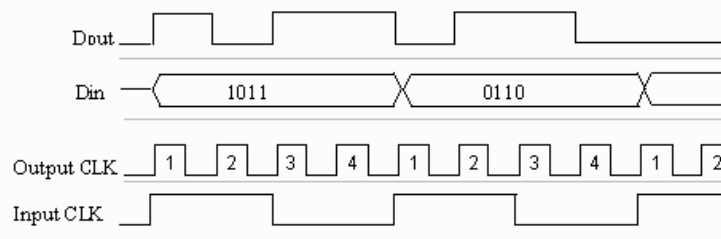

This example illustrates the case where the input width is 4, output word size is 1, and the block is configured to output the most significant word first.

Block Interface

The Parallel to Serial block has one input and one output port. The input port can be any size. The output port size is indicated on the block parameters dialog box.

Block Parameters

The block parameters dialog box can be invoked by double-clicking the icon in your Simulink® model.

- **Basic tab:** Parameters specific to the Basic tab are as follows.
 - **Output order:** Most significant word first or least significant word first.
 - **Type:** Signed or unsigned.

- **Number of bits:** Output width. Must divide Number of Input Bits evenly.
- **Binary Point:** Binary point location.

The minimum latency of this block is 0.

Other parameters used by this block are explained in the topic [Common Options in Block Parameter Dialog Boxes](#).

Product

This block is listed in the following Xilinx® Blockset libraries: DSP, Math, and Index.

The Xilinx Product block implements a scalar or complex multiplier. It computes the product of the data on its two input channels, producing the result on its output channel. For complex multiplication the input and output have two components: real and imaginary.

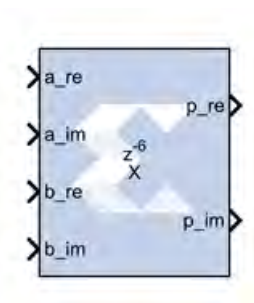

The Product block is ideal for generating a simple scalar or complex multiplier. If your implementation will use more complicated features such as AXI4 ports or a user-specified precision, use the Xilinx [Complex Multiplier 6.0](#) block (if you are configuring a complex multiplier) or Xilinx [Mult](#) block (if you are configuring a scalar multiplier) in your design instead of the Product block.

In the Vivado® design flow, the Product block is inferred as "LogiCORE™ IP Complex Multiplier" (if you have configured the Product block for complex multiplication) or "LogiCORE IP Multiplier" (if you have configured the Product block for scalar multiplication) for code generation. Refer to the [LogiCORE IP Complex Multiplier v6.0 Product Guide](#) or the [LogiCORE IP Multiplier v12.0 Product Guide](#) for details about these LogiCORE IP.

Block Parameters

The block parameters dialog box can be invoked by double-clicking the icon in your Simulink® model.

Parameters specific to the block are as follows.

- **Complex Multiplication:** Specifies mode of operation: scalar multiplier (**Complex Multiplication** deselected) or complex multiplier (**Complex Multiplication** selected).
- **Optimize for:** Specifies whether your design will be optimized for **Performance** or for **Resources** when it is implemented in the Xilinx FPGA or SoC device.

Based on the settings for **Complex Multiplication** and **Optimize for**, and rate and type propagation (from the input data width), the latency value of the block will be derived automatically for a fully pipelined circuit. This latency value will be displayed on the block in the Simulink model.

LogiCORE Documentation

[LogiCORE IP Complex Multiplier v6.0](#)

[LogiCORE IP Multiplier v12.0](#)

Puncture

This block is listed in the following Xilinx® Blockset libraries: Communication and Index.

The Xilinx Puncture block removes a set of user-specified bits from the input words of its data stream.



Based on the puncture code parameter, a binary vector that specifies which bits to remove, it converts input data of type $UF_{i \times N}_0$ (where N is equal to the length of the puncture code) into output data of type $UF_{i \times K}_0$ (where K is equal to the number of ones in the puncture code). The output rate is identical to the input rate.

This block is commonly used in conjunction with a convolution encoder to implement punctured convolution codes as shown in the figure below.

Figure 62: Implementing Punctured Convolutional Codes

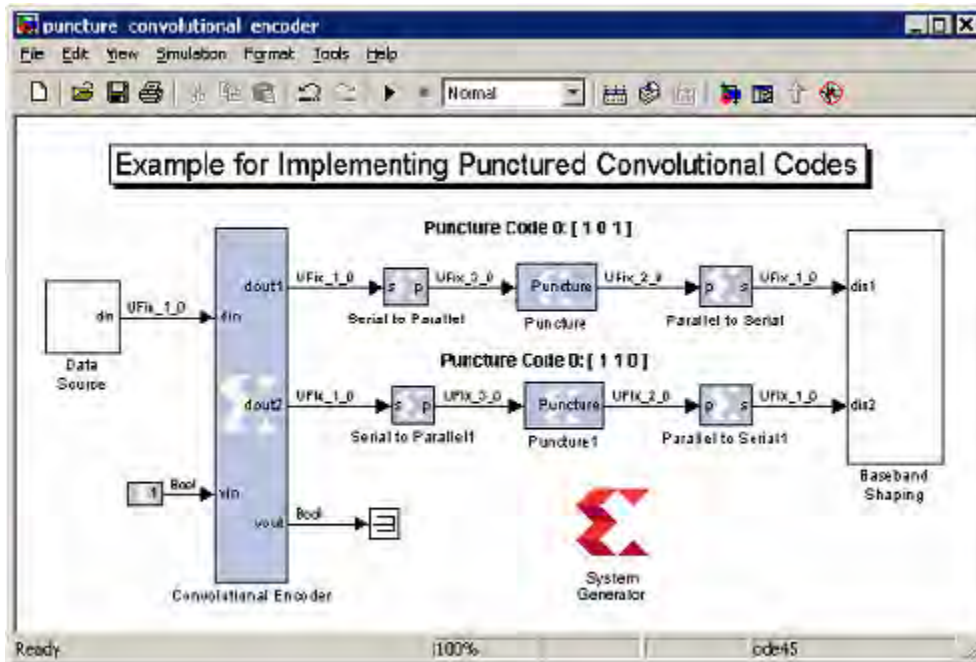

The system shown implements a rate $\frac{1}{2}$ convolution encoder whose outputs are punctured to produce four output bits for each three input bits. The top puncture block removes the center bit for code 0 ($[1\ 0\ 1]$) and bottom puncture block removes the least significant bit for code 1 ($[1\ 1\ 0]$), producing a 2-bit punctured output. These data streams are serialized into 1-bit in-phase and quadrature data streams for baseband shaping.

Block Parameters

The block parameters dialog box can be invoked by double-clicking the icon in your Simulink® model.

Parameters specific to the block are as follows:

- **Puncture Code:** The puncture pattern represented as a bit vector, where a zero in position i indicates bit i is to be removed.

Other parameters used by this block are explained in the topic [Common Options in Block Parameter Dialog Boxes](#).

Reciprocal

This block is listed in the following Xilinx® Blockset libraries: Floating-Point, Math, and Index.

The Xilinx Reciprocal block performs the reciprocal on the input. Currently, only the floating-point data type is supported.

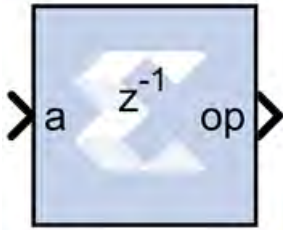

Block Parameters

The block parameters dialog box can be invoked by double-clicking the icon in your Simulink® model.

- **Basic tab:** Parameters specific to the Basic tab are as follows.
 - **Flow Control:**
 - **Blocking:** Selects “Blocking” mode. In this mode, the lack of data on one input channel does block the execution of an operation if data is received on another input channel.
 - **NonBlocking:** Selects “Non-Blocking” mode. In this mode, the lack of data on one input channel does not block the execution of an operation if data is received on another input channel.
- **Optional ports:**
 - **Input Channel Ports:**
 - **Has TLAST:** Adds a TLAST port to the Input channel.
 - **Has TUSER:** Adds a TUSER port to the Input channel.
 - **Provide enable port:** Adds an enable port to the block interface.
 - **Has Result TREADY:** Adds a TREADY port to the Result channel.
 - **Exception Signals:**
 - **UNDERFLOW:** Adds an output port that serves as an underflow flag.
 - **DIVIDE_BY_ZERO:** Adds an output port that serves as a divide-by-zero flag.

LogiCORE Documentation

[LogiCORE IP Floating-Point Operator v7.1](#)

Reciprocal SquareRoot

This block is listed in the following Xilinx® Blockset libraries: Floating-Point, Math, and Index.

The Xilinx Reciprocal SquareRoot block performs the reciprocal squareroot on the input. Currently, only the floating-point data type is supported.

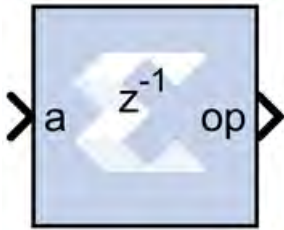

Block Parameters

The block parameters dialog box can be invoked by double-clicking the icon in your Simulink® model.

- **Basic tab:**

Parameters specific to the Basic tab are as follows.

- **Flow Control:**
 - **Blocking:** Selects Blocking mode. In this mode, the lack of data on one input channel does block the execution of an operation if data is received on another input channel.
 - **NonBlocking:** Selects Non-Blocking mode. In this mode, the lack of data on one input channel does not block the execution of an operation if data is received on another input channel.
- **Optional ports:**
 - **Input Channel Ports:**
 - **Has TLAST:** Adds a TLAST port to the Input channel.
 - **Has TUSER:** Adds a TUSER port to the Input channel.
 - **Provide enable port:** Adds an enable port to the block interface.
 - **Has Result TREADY:** Adds a TREADY port to the Result channel.
- **Exception Signals:**
 - **INVALID_OP:** Adds an output port that serves as an invalid operation flag.
 - **DIVIDE_BY_ZERO:** Adds an output port that serves as a divide-by-zero flag.

Other parameters used by this block are explained in the topic [Common Options in Block Parameter Dialog Boxes](#).

LogiCORE Documentation

[LogiCORE IP Floating-Point Operator v7.1](#)

Reed-Solomon Decoder 9.0

This block is listed in the following Xilinx® Blockset libraries: AXI4, Communication, and Index.

Note: This block goes into the FPGA fabric and is a Licensed Core. Please visit the Xilinx web site to purchase the appropriate core license.

The Reed-Solomon (RS) codes are block-based error correcting codes with a wide range of applications in digital communications and storage.

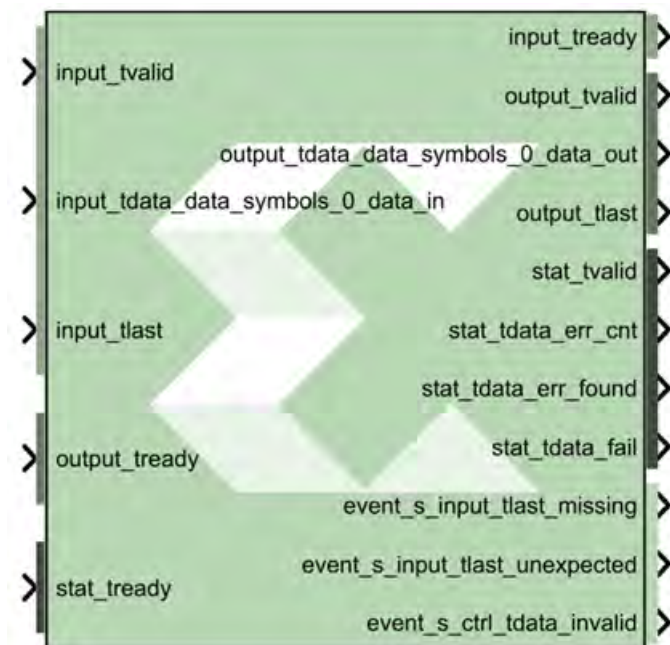

They are used to correct errors in many systems such as digital storage devices, wireless/ mobile communications, and digital video broadcasting.

The Reed-Solomon decoder processes blocks generated by a Reed-Solomon encoder, attempting to correct errors, and recover information symbols. The number and type of errors that can be corrected depend on the characteristics of the code.

Reed-Solomon codes are Bose-Chaudhuri-Hocquenghem (BCH) codes, which in turn are linear block codes. An (n,k) linear block code is a k -dimensional sub-space of an n -dimensional vector space over a finite field. Elements of the field are called *symbols*. For a Reed-Solomon code, n ordinarily is $2^s - 1$, where s is the width in bits of each symbol. When the code is *shortened*, n is smaller. The decoder handles both full length and shortened codes. It is also able to handle *erasures*, that is, symbols that are known with high probability to contain errors.

When the decoder processes a block, there are three possibilities:

1. The information symbols are recovered. This is the case provided $2p+r \leq n-k$, where p is the number of errors, and r is the number of erasures.
2. The decoder reports it is unable to recover the information symbols.
3. The decoder fails to recover the information symbols but does not report an error.

The probability of each possibility depends on the code and the nature of the communications channel. Simulink® provides excellent tools for modeling channels and estimating these probabilities.

Block Interface Channels and Pins

This Xilinx Reed-Solomon Decoder block is AXI4 compliant. The following describes the standard AXI channels and pins on the interface:

- **input Channel:**
 - **input_tvalid:** TVALID for the input channel.
 - **input_tdata_erase:** Added to the channel when you select **Erase** on the Optional Pins tab. It indicates the symbol currently presented on `data_in` should be treated as an erasure. The signal driving this pin must be `Bool`.
 - **input_tdata_data_in:** Presents blocks of n symbols to be decoded. This signal must have type `UFIX_s_0`, where s is the width in bits of each symbol.
 - **input_tlast:** Marks the last symbol of the input block. Only used to generate event outputs. Can be tied low or high if event outputs are not used.
 - **input_tready:** TREADY for the input channel.
 - **input_tuser_mark_in:** marker bits for tagging data on `data_in`. Added to the channel when you select **Marker Bits** from the Optional Pins tab.
- **output Channel:**
 - **output_tready:** TREADY for the output channel.
 - **output_tvalid:** TVALID for the output channel.

- **output_tdata_data_out:** Produces the information and parity symbols resulting from decoding. The type of `data_out` is the same as that for `data_in`.
- **output_tlast:** Goes high when the last symbol of the last block is on `tdata_data_out`. `output_tlast` produces a signal of type `UFIX_1_0`.
- **output_tuser_mark_out:** `mark_in` tagging bits delayed by the latency of the LogiCORE™. Added to the channel when you select **Marker Bits** on the Optional Pins tab.
- **output_tdata_info:** Added to the channel when you select **Info** on the Optional Pins tab. The signal marks the last information symbol of a block on `tdata_data_out`.
- **output_tdata_data_del:** Added to the channel when you select **Original Delayed Data** on the Optional Pins tab. The signal marks the last information symbol of a block on `tdata_data_out`.
- **stat Channel:**
 - **stat_tready:** TREADY for the stat channel.
 - **stat_tvalid:** TVALID for the stat channel. You should tie this signal high if the downstream slave is always able to accept data or if the stat channel is not used.
 - **stat_tdata_err_cnt:** Presents a value at the time `data_out` presents the last symbol of the block. The value is the number of errors that were corrected. `err_cnt` must have type `UFIX_b_0` where `b` is the number of bits needed to represent `n-k`.
 - **stat_tdata_err_found:** presents a value at the time `output_tdata_data_out` presents the last symbol of the block. The value 1 if the decoder detected any errors or erasures during decoding. `err_found` must have type `UFIX_1_0`.
 - **stat_tdata_fail:** Presents a value at the time `output_tdata_data_out` presents the last symbol of the block. The value is 1 if the decoder was unable to recover the information symbols, and 0 otherwise. This signal must be of type `UFIX_1_0`.
 - **stat_tdata_erase_cnt:** Only available when erasure decoding is enabled. Presents a value at the time `dout` presents the last symbol of the block. The value is the number of erasures that were corrected This signal must be of type `UFIX_b_0` where `b` is the number of bits needed to represent `n`. Added to the channel when you select **Erase** from the Optional Pins tab.
 - **stat_tdata_bit_err_1_to_0:** Number of bits received as 1 but corrected to 0. Added to the channel when you select **Error Statistics** from the Optional Pins tab. The element width is the number of binary bits required to represent $((n-k) * \text{Symbol_Width})$.
 - **stat_tdata_bit_err_0_to_1:** Number of bits received as 0 but corrected to 1. Added to the channel when you select **Error Statistics** from the Optional Pins tab. The element width is the number of binary bits required to represent $((n-k) * \text{Symbol_Width})$.
 - **stat_tlast:** Added when Number of Channels parameter is greater than 1. Indicates that status information for the last channel is present on `output_tdata`.

- **event Channel:**
 - **event_s_input_tlast_missing:** This output flag indicates that the `input_tlast` was not asserted when expected. You should leave this pin unconnected if it is not required.
 - **event_s_input_tlast_unexpected:** This output flag indicates that the `input_tlast` was asserted when not expected. You should leave this pin unconnected if it is not required.
 - **event_s_ctrl_tdata_invalid:** This output flag indicates that values provided on `ctrl_tdata` were illegal. The block must be reset if this is asserted. You should leave this pin unconnected if it is not required.
- **ctrl Channel:** This channel is only present when variable block length, number of check symbols or puncture is selected as a block parameter.
 - **ctrl_tready:** TREADY for the ctrl channel.
 - **ctrl_tvalid_r_in:** TVALID for the ctrl channel.
 - **ctrl_tdata:** This input contains the block length, the number of check symbols and puncture select, if applicable.
- **Other Optional Pins:**
 - **aresetn:**

Resets the decoder. This pin is added to the block when you specify **Synchronous Reset** on the Optional Pins tab. The signal driving `rst` must be `Bool`.

`aresetn` must be asserted high for at least 1 sample period before the decoder can start decoding code symbols.
 - **aclken:** Carries the clock enable signal for the decoder. The signal driving `aclken` must be `Bool`. Added to the block when you select the optional pin **Clock Enable**.

Block Parameters

The block parameters dialog box can be invoked by double-clicking the icon in your Simulink® model.

- **Attributes 1 tab:** Parameters specific to the Attributes 1 tab are as follows.
 - **Code Block Specification:**
 - **Code specification:** Specifies the type of RS Decoder desired. The choices are as follows.
 - **Custom:** Allows you to set all the block parameters.
 - **DVB:** Implements DVB (Digital Video Broadcasting) standard (204, 188) shortened RS code.

- **ATSC:** Implements ATSC (Advanced Television Systems Committee) standard (207, 187) shortened RS code.
- **G.709:** Implements G.709 Optical Transport Network standard.
- **CCSDS:** Implements CCSDS (Consultative Committee for Space Data Systems) standard (255, 223) full length RS code.
- **IESS-308 (All):** Implements IESS-308 (INTELSAT Earth Station Standard) specification (all) shortened RS code.
- **IESS-308 (126):** Implements IESS-308 (INTELSAT Earth Station Standard) specification (126, 112) shortened RS code.
- **IESS-308 (194):** Implements IESS-308 specification (194, 178) shortened RS code.
- **IESS-308 (208):** Implements IESS-308 specification (208, 192) shortened RS code.
- **IESS-308 (219):** Implements IESS-308 specification (219, 201) shortened RS code.
- **IESS-308 (225):** Implements IESS-308 specification (225, 205) shortened RS code.
- **IEEE-802.16:** Implements IEEE-802.16 specification (255, 239) full length RS code.
- **Symbol width:** Tells the width in bits for symbols in the code. The encoder support widths from 3 to 12 (default 8).
- **Field polynomial:** Specifies the polynomial from which the symbol field is derived. It must be specified as a decimal number. This polynomial must be primitive. A value of zero indicates the default polynomial should be used. Default polynomials are listed in the table below.

Table 20: Field Polynomials

Symbol Width	Default Polynomials	Array Representation
3	$x^3 + x + 1$	11
4	$x^4 + x + 1$	19
5	$x^5 + x^2 + 1$	37
6	$x^6 + x + 1$	67
7	$x^7 + x^3 + 1$	137
8	$x^8 + x^4 + x^3 + x^2 + 1$	285
9	$x^9 + x^4 + 1$	529
10	$x^{10} + x^3 + 1$	1033
11	$x^{11} + x^2 + 1$	2053
12	$x^{12} + x^6 + x^4 + x + 1$	4179

- **Scaling Factor (h):** (represented in the previous formula as h) specifies the scaling factor for the code. Ordinarily, h is 1, but can be as large as $2^S - 1$ where s is the symbol width. The value must be chosen so that α^h is primitive. That is, h must be relatively prime to $2^S - 1$.
- **Generator Start:** specifies the first root r of the generator polynomial. The generator polynomial g(x), is given by:

$$g(x) = \prod_{j=0}^{n-k-1} (x - \alpha^{h(r+j)})$$

where α is a primitive element of the symbol field, and the scaling factor is described below.

- **Variable Block Length:** When checked, the block is given a `ctrl` input channel.
- **Symbols Per Block(n):** Tells the number of symbols in the blocks the encoder produces. Acceptable numbers range from 3 to $2^S - 1$, where s denotes the symbol width.
- **Data Symbols(k):** Tells the number of information symbols each block contains. Acceptable values range from $\max(n - 256, 1)$ to $n - 2$.
- **Variable Check Symbol Options:**
 - **Variable Number of Check Symbols (r):**
 - **Define Supported R_IN Values:**

If only a subset of the possible values that could be sampled on R_IN is actually required, then it is possible to reduce the size of the core slightly. For example, for the Intelsat standard, the R_IN input is 5 bits wide but only requires r values of 14, 16, 18, and 20. The core size can be slightly reduced by defining only these four values to be supported. If any other value is sampled on R_IN, the core will not decode the data correctly.
 - **Number of Supported R_IN Values:** Specify the number of supported R_IN values.
 - **Supported R_IN Definition File:** This is a COE file that defines the R values to be supported. It has the following format: `radix=10; legal_r_vector=14,16,18,20;` The number of elements in the `legal_r_vector` must equal the specified **Number of Supported R_IN Values**.
- **Attributes 2 tab:**
 - **Implementation:**
 - **State Machine:**

- **Self Recovering:** When checked, the block synchronously resets itself if it enters an illegal state.
- **Memory Style:** Select between **Distributed**, **Block** and **Automatic** memory choices.
- **Number Of Channels:** Specifies the number of separate time division multiplexed channels to be processed by the encoder. The encoder supports up to 128 channels.
- **Output check symbols:** If selected, then the entire n symbols of each block are output on the output channel. If not selected, then only the k information symbols are output.
- **Puncture Options:**
 - **Number of Puncture Patterns:** Specifies how many puncture patterns the LogiCORE needs to handle. It is set to 0 if puncturing is not required.
 - **Puncture Definition File:** Specifies the pathname of the puncture definition file that is used to define the puncture patterns.

A relative pathname can be specified for a COE file in the current working directory. For example, the syntax is [cwd '/ieee802_16d_puncturing.coe'].
- **Optional pins tab:**
 - **Clock Enable:** Adds a `aclken` pin to the block. This signal carries the clock enable and must be of type Bool.
 - **Info:** Adds the `output_tdata_info` pin. Marks the last information symbol of a block on `tdata_data_out`.
 - **Synchronous Reset:** Adds a `aresetn` pin to the block. This signal resets the block and must be of type Bool. The signal must be asserted for at least 2 clock cycles, however, it does not have to be asserted before the decoder can start decoding.
 - **Original Delayed Data:** When checked, the block is given a `tdata_data_del` output. Indicates that a DAT_DEL field is in the `output_tdata` output.
 - **Erase:** When checked, the block is given an `input_tdata_erase` input pin.
 - **Error Statistics:** adds the following error statistics outputs:
 - **bit_err_0_to_1:** Number of bits received as 1 but corrected to 0.
 - **bit_err_1_to_0:** Number of bits received as 0 but corrected to 1.
 - **Marker Bits:** Adds the following pins to the block:
 - **input_tuser_mark_in:** Carries marker bits for tagging data on `input_tdata_data_in`.
 - **output_tuser_mark_out:** Mark_in tagging bits delayed by the latency of the LogiCORE.
 - **Number of Marker Bits:** Specifies the number of marker bits.

Other parameters used by this block are explained in the topic [Common Options in Block Parameter Dialog Boxes](#).

LogiCORE Documentation

[LogiCORE IP Reed-Solomon Decoder v9.0](#)

Reed-Solomon Encoder 9.0

This block is listed in the following Xilinx® Blockset libraries: AXI4, Communications, and Index.

Note: This block goes into the FPGA fabric and is a Licensed Core. Please visit the Xilinx web site to purchase the appropriate core license.

The Reed-Solomon (RS) codes are block-based error correcting codes with a wide range of applications in digital communications and storage. This block adheres to the AMBA® AXI4-StreamAXI4-Stream standard.

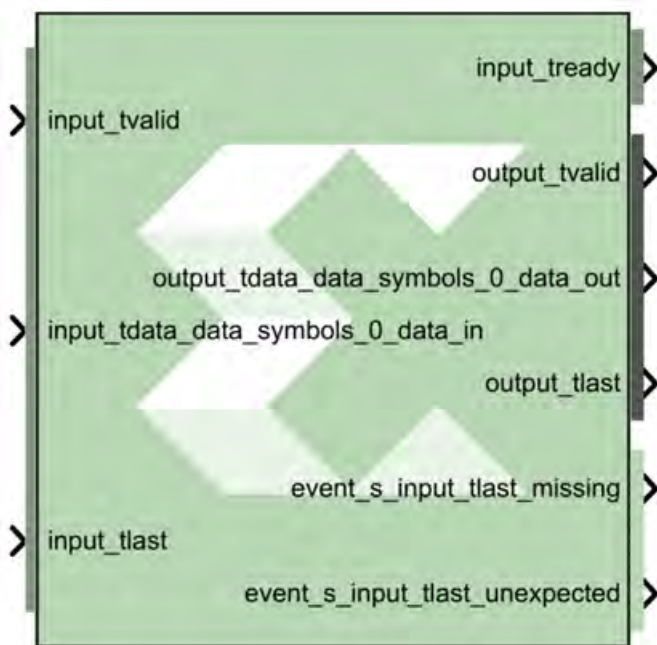

They are used to correct errors in many systems such as digital storage devices, wireless or mobile communications, and digital video broadcasting.

The Reed-Solomon encoder augments data blocks with redundant symbols so that errors introduced during transmission can be corrected. Errors can occur for a number of reasons (noise or interference, scratches on a CD, etc.). The Reed-Solomon decoder attempts to correct errors and recover the original data. The number and type of errors that can be corrected depends on the characteristics of the code.

A typical system is shown below:

Figure 63: Typical System

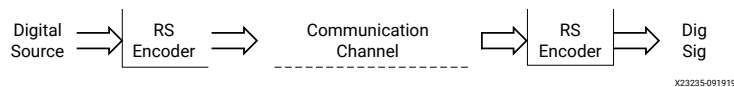

Reed-Solomon codes are Bose-Chaudhuri-Hocquenghem (BCH) codes, which in turn are linear block codes. An (n, k) linear block code is a k -dimensional sub space of an n -dimensional vector space over a finite field. Elements of the field are called symbols. For a Reed-Solomon code, n ordinarily is $2^s - 1$, where s is the width in bits of each symbol. When the code is shortened, n is smaller. The encoder handles both full length and shortened codes.

The encoder is systematic. This means it constructs code blocks of length n from information blocks of length k by adjoining $n-k$ parity symbols.

Figure 64: Systematic Encoder

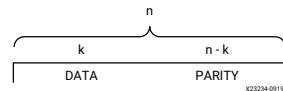

A Reed-Solomon code is characterized by its field and generator polynomials. The field polynomial is used to construct the symbol field, and the generator polynomial is used to calculate parity symbols. The encoder allows both polynomials to be configured. The generator polynomial has the form:

$$g(x) = (x - \alpha^j)(x - \alpha^{j+1}) \dots (x - \alpha^{i+n-k-1})$$

where α is a primitive element of the finite field having $n + 1$ elements.

Block Interface Channels and Pins

The Xilinx Reed-Solomon Decoder 8.0 block is AXI4 compliant. The following describes the standard AXI channels and pins on the interface:

- **input Channel:**
 - **input_tvalid:** TVALID for the input channel.

- **input_tdata_data_in:** Presents blocks of n symbols to be decoded. This signal must have type `UFIX_s_0`, where s is the width in bits of each symbol.
- **input_tlast:** Marks the last symbol of the input block. Only used to generate event outputs. Can be tied low or high if event outputs are not used.
- **input_tready:** TREADY for the input channel.
- **input_tuser_marker:** Marker bits for tagging data on `input_tdata_data_in`. Added to the channel when you select **Marker Bits** from the Detailed Implementation tab.
- **output Channel:**
 - **output_tready:** TREADY for the output channel. Added to the channel when you select **Output TREADY** from the Optional Pins tab.
 - **output_tvalid:** TVALID for the output channel.
 - **output_tdata_data_out:** Produces the information and parity symbols resulting from decoding. The type of `data_out` is the same as that for `data_in`.
 - **output_tlast:** Goes high when the last symbol of the last block is on `tdata_data_out`. `output_tlast` produces a signal of type `UFIX_1_0`.
 - **output_tuser_maker:** This pin is available when user selects "Marker Bits" from the Detailed Implementation tab.
- **event Channel:**
 - **event_s_input_tlast_missing:** This output flag indicates that the `input_tlast` was not asserted when expected. You should leave this pin unconnected if it is not required.
 - **event_s_input_tlast_unexpected:** This output flag indicates that the `input_tlast` was asserted when not expected. You should leave this pin unconnected if it is not required.
 - **event_s_ctrl_tdata_invalid:** This output flag indicates that values provided on `ctrl_tdata` were illegal. This pin is available when "Variable Block Length" or "Variable Number of Check Symbols" are selected on the GUI.
- **ctrl Channel:** This channel is only present when variable block length or number of check symbols is selected as a block parameter.
 - **ctrl_tvalid:** TVALID for the ctrl channel.
 - **ctrl_tdata_n_in:** This signal is only present if "Variable Block Length" is selected in the GUI. This allows the block length to be changed every block. The `ctrl_tdata_n_in` signal must have type `UFIX_s_0`, where s is the width in bits of each symbol. Unless there is an `R_IN` field, the number of check symbols is fixed, so varying n automatically varies k .

- **ctrl_tdata_r_in:** This field is only present if “Variable Number of Check Symbols” is selected in the GUI. It allows the number of check symbols to be changed every block. The new block's length, r_block , is set to $ctrl_tdata_r_in$ sampled. The $ctrl_tdata_r_in$ signal must have type $U_{FIX_p_0}$, where p is the number of bits required to represent the parity bits ($n-k$) in the default code word, n being the "Symbols Per Block" and k being "Data Symbols". Selecting this input significantly increases the size of the core.

Other Optional Pins

- **aresetn:** Resets the encoder. This pin is added to the block when you specify **ARESETn** on the Detailed Implementation tab. The signal driving **ARESETn** must be Bool.

aresetn must be asserted low for at least 2 clock periods and at least 1 sample period before the decoder can start decoding code symbols.

- **aclken:** Carries the clock enable signal for the encoder. The signal driving **aclken** must be Bool. Added to the block when you select the optional pin **ACLKEN**.

Block Parameters

The block parameters dialog box can be invoked by double-clicking the icon in your Simulink® model.

- **Attributes:** Parameters specific to the Attributes tab are as follows.
 - **Code Block Specification:**
 - **Code specification:** specifies the encoder type desired. The choices are:
 - **Custom:** Allows you to set all the block parameters.
 - **DVB:** Implements DVB (Digital Video Broadcasting) standard (204, 188) shortened RS code.
 - **ATSC:** Implements ATSC (Advanced Television Systems Committee) standard (207, 187) shortened RS code
 - **G_709:** Implements G.709 Optical Transport Network standard.
 - **ETSI_BRAN:** Implements the ETSI Project standard for Broadband Radio Access Networks (BRAN).
 - **CCSDS:** Implements CCSDS (Consultative Committee for Space Data Systems) standard (255, 223) full length RS code.
 - **ITU_J_83_Annex_B:** Implements International Telecommunication Union (ITU)-J.83 Annex B specification (128, 122) extended RS code.
 - **IESS-308 (126):** Implements IESS-308 (INTELSAT Earth Station Standard) specification (126, 112) shortened RS code.

- **IESS-308 (194):** Implements IESS-308 specification (194, 178) shortened RS code.
- **IESS-308 (208):** Implements IESS-308 specification (208, 192) shortened RS code.
- **IESS-308 (219):** Implements IESS-308 specification (219, 201) shortened RS code.
- **IESS-308 (225):** Implements IESS-308 specification (225, 205) shortened RS code.
- **Variable Number of Check Symbols (r):** False, true. When checked, the ctrl_tdata_r_in and ctrl_tdata_n_in pins become available on the block.
- **Variable Block Length:** False, true. When checked, the ctrl_tdata_n_in pin becomes available on the block.
- **Symbol width:** Tells the width in bits for symbols in the code. The encoder support widths from 3 to 12 and the default value is 8.
- **Field polynomial:** specifies the polynomial from which the symbol field is derived. It must be specified as a decimal number. This polynomial must be primitive. A value of zero indicates the default polynomial should be used. Default polynomials are listed in the table below.

Table 21: Field Polynomials

Symbol Width	Default Polynomials	Array Representation
3	$x^3 + x + 1$	11
4	$x^4 + x + 1$	19
5	$x^5 + x^2 + 1$	37
6	$x^6 + x + 1$	67
7	$x^7 + x^3 + 1$	137
8	$x^8 + x^4 + x^3 + x^2 + 1$	285
9	$x^9 + x^4 + 1$	529
10	$x^{10} + x^3 + 1$	1033
11	$x^{11} + x^2 + 1$	2053
12	$x^{12} + x^6 + x^4 + x + 1$	4179

- **Scaling Factor (h):** (represented in the previous formula as h) specifies the scaling factor for the code. Ordinarily, h is 1, but can be as large as $2^S - 1$ where s is the symbol width. The value must be chosen so that α^h is primitive. That is, h must be relatively prime to $2^S - 1$.
- **Generator Start:** Specifies the first root r of the generator polynomial. The generator polynomial g(x), is given by:

$$g(x) = \prod_{j=0}^{n-k-1} (x - \alpha^{h(r+j)})$$

where α is a primitive element of the symbol field, and the scaling factor is described below.

- **Symbols Per Block(n):** Tells the number of symbols in the blocks the encoder produces. Acceptable numbers range from 3 to $2^S - 1$, where s denotes the symbol width.
- **Data Symbols(k):** Tells the number of information symbols each block contains. Acceptable values range from $\max(n - 256, 1)$ to $n - 2$.
- **Detailed Implementation tab:**
 - **Implementation:**
 - **Check Symbol Generator Optimization:** This option is available when "Variable Number of Check Symbols" option is selected on the GUI.
 - **Fixed Architecture:** The check symbol generator is implemented using a highly efficient fixed architecture.
 - **Area:** The check symbol generator implementation is optimized for area and speed efficiency. The range of input, `ctrl_tdata_n_in`, is reduced.
 - **Flexibility:** The check symbol generator implementation is optimized to maximize the range of input of `ctrl_tdata_n_in`.
 - **Memory Style:** Select between **Distributed**, **Block** and **Automatic** memory choices. This option is available only for CCSDS codes.
 - **Number Of Channels:** Specifies the number of separate time division multiplexed channels to be processed by the encoder. The encoder supports up to 128 channels.
 - **Optional Pins:**
 - **ACLKEN:** Adds a `aclken` pin to the block. This signal carries the clock enable and must be of type Bool.
 - **Output TREADY:** When selected, the output channels will have a TREADY and hence support the AXI4handshake protocol with inherent back-pressure.
 - **ARESETn:** Adds a `aresetn` pin to the block. This signal resets the block and must be of type Bool. `aresetn` must be asserted low for at least 2 clock periods and at least 1 sample period before the decoder can start decoding code symbols.
 - **Info bit:** Adds the `output_tdata_info` pin. Marks the last information symbol of a block on `tdata_data_out`.
 - **Marker Bits:** Adds the following pins to the block:
 - **input_tuser_user:** Carries marker bits for tagging data on `input_tdata_data_in`.
 - **output_tuser_user:** `mark_in` tagging bits delayed by the latency of the LogiCORE.

- **Number of Marker Bits:** Specifies the number of marker bits.

Other parameters used by this block are explained in the topic [Common Options in Block Parameter Dialog Boxes](#).

LogiCORE Documentation

[LogiCORE IP Reed-Solomon Encoder v9.0](#)

Register

This block is listed in the following Xilinx® Blockset libraries: Basic Elements, Control Logic, Memory, Floating-Point, and Index.

The Xilinx Register block models a D flip-flop-based register, having latency of one sample period.

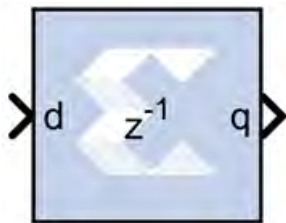

Block Interface

The block has one input port for the data and an optional input reset port. The initial output value is specified by you in the block parameters dialog box (below). Data presented at the input will appear at the output after one sample period. Upon reset, the register assumes the initial value specified in the parameters dialog box.

The Register block differs from the Xilinx Delay block by providing an optional reset port and a user specifiable initial value.

Block Parameters

The block parameters dialog box can be invoked by double-clicking the icon in your Simulink® model.

- **Basic tab:**

Parameters specific to the Basic tab are as follows.

- **Initial value:** specifies the initial value in the register.

- **Optional Ports:**

Other parameters used by this block are explained in the topic [Common Options in Block Parameter Dialog Boxes](#).

Xilinx LogiCORE

The Register block is implemented as a synthesizable VHDL module. It does not use a Xilinx LogiCORE™.

Reinterpret

This block is listed in the following Xilinx® Blockset libraries: Basic Elements, Floating-Point, Math, and Index.

The Xilinx Reinterpret block forces its output to a new type without any regard for retaining the numerical value represented by the input.



The binary representation is passed through unchanged, so in hardware this block consumes no resources. The number of bits in the output will always be the same as the number of bits in the input.

The block allows for unsigned data to be reinterpreted as signed data, or, conversely, for signed data to be reinterpreted as unsigned. It also allows for the reinterpretation of the data's scaling, through the repositioning of the binary point within the data. The Xilinx Scale block provides an analogous capability.

An example of this block's use is as follows: if the input type is 6 bits wide and signed, with 2 fractional bits and the output type is forced to be unsigned with 0 fractional bits, then an input of -2.0 (1110.00 in binary, two's complement) would be translated into an output of 56 (111000 in binary).

This block can be particularly useful in applications that combine it with the Xilinx Slice block or the Xilinx Concat block. To illustrate the block's use, consider the following scenario:

Given two signals, one carrying signed data and the other carrying two unsigned bits (a UFix_2_0), we want to design a system that concatenates the two bits from the second signal onto the tail (least significant bits) of the signed signal.

We can do so using two Reinterpret blocks and one Concat block. The first Reinterpret block is used to force the signed input signal to be treated as an unsigned value with its binary point at zero. The result is then fed through the Concat block along with the other signal's UFix_2_0. The Concat operation is then followed by a second Reinterpret that forces the output of the Concat block back into a signed interpretation with the binary point appropriately repositioned.

Though three blocks are required in this construction, the hardware implementation is realized as simply a bus concatenation, which has no cost in hardware.

Block Parameters

Parameters specific to the block are as follows.

- **Force Arithmetic Type:** When checked, the Output Arithmetic Type parameter can be set and the output type is forced to the arithmetic type chosen according to the setting of the Output Arithmetic Type parameter. When unchecked, the arithmetic type of the output is unchanged from the arithmetic type of the input.
- **Output Arithmetic Type:** The arithmetic type (unsigned or signed, 2's complement, Floating-point) to which the output is to be forced.
- **Force Binary Point:** When checked, the Output Binary Point parameter can be set and the binary point position of the output is forced to the position supplied in the Output Binary Point parameter. When unchecked, the arithmetic type of the output is unchanged from the arithmetic type of the input.
- **Output Binary Point:** The position to which the output's binary point is to be forced. The supplied value must be an integer between zero and the number of bits in the input (inclusive).

LogiCORE Documentation

[LogiCORE IP Floating-Point Operator v7.1](#)

Relational

This block is listed in the following Xilinx® Blockset libraries: Basic Elements, Control Logic, Floating-Point, Math, and Index.

The Xilinx Relational block implements a comparator.

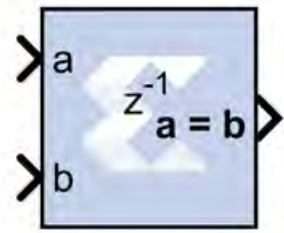

The supported comparisons are the following:

- equal-to ($a = b$)
- not-equal-to ($a \neq b$)
- less-than ($a < b$)
- greater-than ($a > b$)
- less-than-or-equal-to ($a \leq b$)
- greater-than-or-equal-to ($a \geq b$)
- The output of the block is a `Bool`.

Block Parameters

The block parameters dialog box can be invoked by double-clicking the icon in your Simulink® model.

The only parameter specific to the Relational block is:

- **Comparison:** specifies the comparison operation computed by the block.

Other parameters used by this block are explained in the topic [Common Options in Block Parameter Dialog Boxes](#).

LogiCORE Documentation

[LogiCORE IP Floating-Point Operator v7.1](#)

Requantize

This block is listed in the following Xilinx® Blockset libraries: Basic Elements, Data Types, Math, and Index.

The Xilinx Requantize block requantizes and scales its input signals.



The Xilinx Requantize block requantizes each input sample to a number of a desired fixed point precision output. For example, a fixed point signed (two's complement) or unsigned number can be requantized to an output with lesser or greater number of bits and realign its binary point precision.

This block also scales its input by a power of two. The power can be either positive or negative. The scale operation has the effect of moving the binary point without changing the bits in the container.

The Requantize block is used to requantize and scale its input signals. If you are only performing one of these operations, but not both, you can use a different block in the Xilinx blockset to perform that operation.

- To requantize your input without scaling, use the [Convert](#) block in the Xilinx blockset.
- To scale your input without requantizing, use the [Scale](#) block in the Xilinx blockset.

Quantization

Quantization errors occur when the number of fractional bits is insufficient to represent the fractional portion of a value. This block uses symmetric round during quantization for any insufficient input data.

Round (unbiased: +/- inf) is also known as "Symmetric Round (towards +/- inf)" or "Symmetric Round (away from zero)". This is similar to the MATLAB `round()` function. This method rounds the value to the nearest desired bit away from zero. When there is a value at the midpoint between two possible rounded values, the one with the larger magnitude is selected. For example, to round 01.0110 to a Fix_4_2, this yields 01.10, since 01.0110 is halfway between 01.01 and 01.10, and 01.10 is further from zero.

Overflow

Overflow errors occur when a value lies outside the representable range. In case of data overflow this block saturates the data to the largest positive/smallest negative value.

Block Parameters

The block parameters dialog box can be invoked by double-clicking the icon in your Simulink model.

Parameters specific to the block are as follows.

- **Scale factor s (scale output by 2^s):** The scale factor can be a positive or negative integer. The output of the block is $i \cdot 2^k$, where i is the input value and k is the scale factor. The effect of scaling is to move the binary point, which in hardware has no cost (a shift, on the other hand, might add logic).
- **Fixed-point Precision:**
 - **Number of bits:** Specifies the total number of bits, including the binary point bit width.
 - **Binary point:** Specifies the bit location of the binary point. Bit zero is the Least Significant Bit.

Reset Generator

This block is listed in the following Xilinx Blockset libraries: Basic Elements, and Index.

The Reset Generator block captures the user's reset signal that is running at the system sample rate, and produces one or more downsampled reset signal(s) running at the rates specified on the block.



The downsampled reset signals are synchronized in the same way as they are during startup. The RDY output signal indicates when the downsampled resets are no longer asserted after the input reset is detected.

Block Parameters

The block parameters dialog box shown below can be invoked by double-clicking the icon in your Simulink® model.

Figure 65: Block Parameters

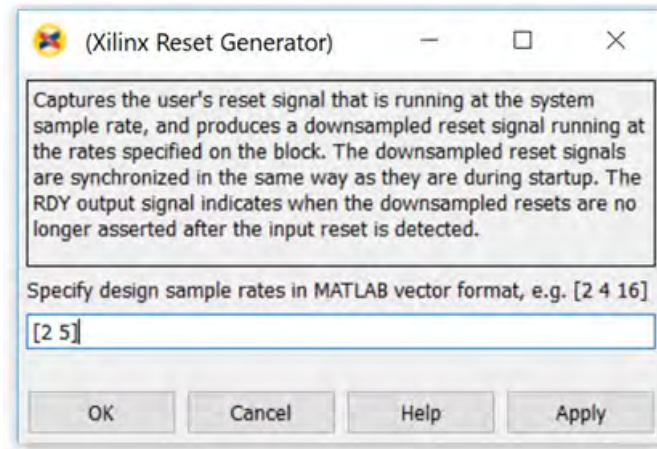

You specify the design sample rates in MATLAB® vector format as shown above. Any number of outputs can be specified.

ROM

This block is listed in the following Xilinx® Blockset libraries: Control Logic, Memory, Floating-Point, and Index.

The Xilinx ROM block is a single port read-only memory (ROM).

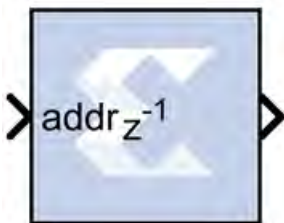

Values are stored by word and all words have the same arithmetic type, width, and binary point position. Each word is associated with exactly one address. An address can be any unsigned fixed-point integer from 0 to $d-1$, where d denotes the ROM depth (number of words). The memory contents are specified through a block parameter. The block has one input port for the memory address and one output port for data out. The address port must be an unsigned fixed-point integer. The block has two possible Xilinx LogiCORE™ implementations, using either distributed or block memory.

Block Parameters

The block parameters dialog box can be invoked by double-clicking the icon in your Simulink® model.

- **Basic tab:**

Parameters specific to the Basic tab are as follows.

- **Depth:** Specifies the number of words stored; must be a positive integer.
- **Initial value vector:** Specifies the initial value. When the vector is longer than the ROM depth, the vector's trailing elements are discarded. When the ROM is deeper than the vector length, the ROM's trailing words are set to zero. The initial value vector is saturated or rounded according to the data precision specified for the ROM.
- **Memory Type:** Specifies whether the ROM will be implemented using Distributed ROM or Block ROM. Depending on your selection, the ROM will be inferred or implemented as follows when the design is compiled:
 - If the block will be implemented in Distributed memory, the Distributed Memory Generator v8.0 LogiCORE IP will be inferred or implemented when the design is compiled. This is described in *Distributed Memory Generator LogiCORE IP Product Guide (PG063)*.
 - If the block will be implemented in block RAM, the XPM_MEMORY_SPROM (Single Port ROM) macro will be inferred or implemented when the design is compiled. For information on the XPM_MEMORY_SPROM Xilinx Parameterized Macro (XPM), refer to *UltraScale Architecture Libraries Guide (UG974)*.
- **Optional Ports:**
 - **Provide reset port for output register:** When selected, allows access to the reset port available on the output register of the Block ROM. The reset port is available only when the latency of the Block ROM is set to 1.
 - **Initial value for output register:** Specifies the initial value for output register. The initial value is saturated and rounded according to the data precision specified for the ROM.
- **Output tab:** Parameters specific to the Output tab are as follows.
 - **Output Type:** Specify the data type of the output.
 - Boolean
 - Fixed-point
 - Floating-point
 - **Arithmetic Type:** If the Output Type is specified as Fixed-point, you can select **Signed (2's comp)** or **Unsigned** as the Arithmetic Type.

- **Fixed-point Precision:**
 - **Number of bits:** Specifies the bit location of the binary point of the output number, where bit zero is the least significant bit.
 - **Binary point:** Position of the binary point. in the fixed-point output.
- **Floating-point Precision:**
 - **Single:** Specifies single precision (32 bits).
 - **Double:** Specifies double precision (64 bits).
 - **Custom:** Activates the field below so you can specify the Exponent width and the Fraction width.
- **Exponent width:** Specify the exponent width.
- **Fraction width:** Specify the fraction width.

Other parameters used by this block are explained in the topic [Common Options in Block Parameter Dialog Boxes](#).

LogiCORE Documentation

[LogiCORE IP Distributed Memory Generator v8.0](#)

[UltraScale Architecture Libraries Guide - XPM_MEMORY_SPROM Macro \(UltraRAM\)](#)

For the block memory, the address width must be equal to $\text{ceil}(\log_2(d))$ where d denotes the memory depth. The maximum width of data words in the block memory depends on the depth specified; the maximum depth is depends on the device family targeted. The tables below provide the maximum data word width for a given block memory depth.

Sample Time

This block is listed in the following Xilinx Blockset libraries: Tools and Index.

The Sample Time block reports the normalized sample period of its input. A signal's normalized sample period is not equivalent to its Simulink absolute sample period. In hardware, this block is implemented as a constant.

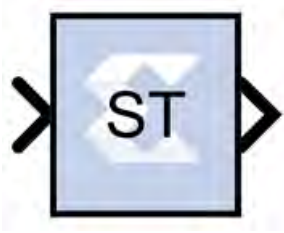

Scale

This block is listed in the following Xilinx® Blockset libraries: Data Types, Math, and Index.

The Xilinx Scale block scales its input by a power of two. The power can be either positive or negative. The block has one input and one output. The scale operation has the effect of moving the binary point without changing the bits in the container



Block Parameters

The block parameters dialog box can be invoked by double-clicking the icon in your Simulink® model.

The only parameter that is specific to the Scale block is Scale factor s . It can be a positive or negative integer. The output of the block is $i \cdot 2^k$, where i is the input value and k is the scale factor. The effect of scaling is to move the binary point, which in hardware has no cost (a shift, on the other hand, might add logic).

Other parameters used by this block are explained in the topic [Common Options in Block Parameter Dialog Boxes](#).

Xilinx LogiCORE

The Scale block does not use a Xilinx LogiCORE.

Serial to Parallel

This block is listed in the following Xilinx® Blockset libraries: Basic Elements, Data Types, and Index.

The Serial to Parallel block takes a series of inputs of any size and creates a single output of a specified multiple of that size. The input series can be ordered either with the most significant word first or the least significant word first.

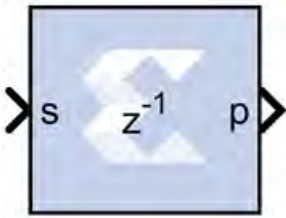

The following waveform illustrates the block's behavior:

Figure 66: Serial to Parallel Behavior

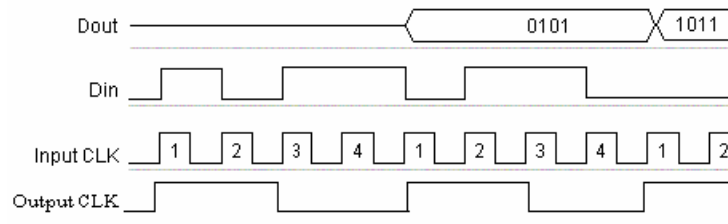

This example illustrates the case where the input width is 1, output width is 4, word size is 1 bit, and the block is configured for most significant word first.

Block Interface

The Serial to Parallel block has one input and one output port. The input port can be any size. The output port size is indicated on the block parameters dialog box.

Block Parameters

The block parameters dialog box can be invoked by double-clicking the icon in your Simulink® model.

- **Basic tab:** Parameters specific to the Basic tab are as follows.
 - **Input order:** Least or most significant word first.
 - **Arithmetic type:** Signed or unsigned output.

- **Number of bits:** Output width which must be a multiple of the number of input bits.
- **Binary point:** Output binary point location

Other parameters used by this block are explained in the topic [Common Options in Block Parameter Dialog Boxes](#).

An error is reported when the number of output bits cannot be divided evenly by the number of input bits. The minimum latency for this block is zero.

Shift

This block is listed in the following Xilinx® Blockset libraries: Control Logic, Data Types, Math, and Index.

The Xilinx Shift block performs a left or right shift on the input signal. The result will have the same fixed-point container as that of the input.



Block Parameters

Parameters specific to the Shift block are:

- **Shift direction:** specifies a direction, Left or Right. The Right shift moves the input toward the least significant bit within its container, with appropriate sign extension. Bits shifted out of the container are discarded. The Left shift moves the input toward the most significant bit within its container with zero padding of the least significant bits. Bits shifted out of the container are discarded.
- **Number of bits:** specifies how many bits are shifted. If the number is negative, direction selected with Shift direction is reversed.

Other parameters used by this block are explained in the topic [Common Options in Block Parameter Dialog Boxes](#).

Xilinx LogiCORE

The Shift block does not use a Xilinx LogiCORE™.

Sine Wave

This block is listed in the following Xilinx® Blockset libraries: DSP and Index.

The Xilinx Sine Wave block generates a sine wave, using simulation time as the time source.

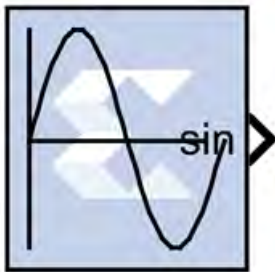

The Xilinx Sine Wave block outputs a sinusoidal waveform. Outputs from the block can be a sine wave, a cosine wave, or both. When implemented in a Xilinx FPGA or SoC, the Sine Wave block optimizes the block parameters for your target device.

The output of the Sine Wave block is determined by this equation:

$$y = \sin(2\pi(k+o)/p)$$

where

p = number of time samples per sine wave period

k = repeating integer value that ranges from 0 to $p-1$

o = offset (phase shift) of the signal

In this block, Xilinx System Generator sets k equal to 0 at the first time step and computes the block output, using the formula above. At the next time step, Simulink increments k and re-computes the output of the block. When k reaches p , Simulink resets k to 0 before computing the block output. This process continues until the end of the simulation.

The output characteristic of the Sine Wave block is determined by:

$$\text{Samples per period} = 2\pi / (\text{Frequency} * \text{Sample Time})$$

$$\text{Number of offset samples} = \text{Phase Offset} * \text{Samples per period} / 2\pi$$

The Sine Wave block is ideal for generating simple sine and cosine waves. If your sine wave implementation will use more complicated DDS features such as a phase generator, multiple channel support, or AXI4 ports, use the Xilinx [DDS Compiler 6.0](#) block in your design instead of the Sine Wave block.

In the Vivado design flow, the Sine Wave block is inferred as "LogicCore IP DDS Compiler v6.0" for code generation.

Block Parameters

The block parameters dialog box can be invoked by double-clicking the icon in your Simulink® model.

Parameters specific to the block are as follows:

- **System Parameters:**
 - **Select the input format:** Specifies whether the frequency and phase offset inputs are entered as a **Frequency** (Hz) or an angular velocity (**Radians**) value.
 - **Frequency:** Specifies the frequency, either in Hertz or radians. The default is 1.
 - **Phase Offset:** Specifies the phase shift, either in Hertz or radians. The default is 0.
- **Output Selection:**
 - **Sine_and_Cosine:** Places both a sine and cosine output port on the block.
 - **Sine:** Places only a sine output port on the block.
 - **Cosine:** Places only a cosine output port on the block.
- **Spurious Free Dynamic Range (SFDR):** Specifies the precision of the output produced by the Sine Wave block. This sets the output width as well as internal bus widths, and controls various implementation decisions.
- **Explicit Sample Period:** If checked, the Sine Wave block uses the explicit sample time specified in the **Sample Period** box below. If not checked, the System Generator base period will be used as block sample time.
- **Sample Period:** If **Explicit Sample Period** is selected, specifies the sample time for the block.

Example

A simple use case of generating sinusoidal signal using Sine Wave block is shown below.

To generate a 20 KHz sine wave with $\pi/2$ phase offset in a system running at sample period of $(1/1e6)$ or 1 MHz, use the following specification on the Sine Wave block.

Figure 67: Sine Wave Specifications

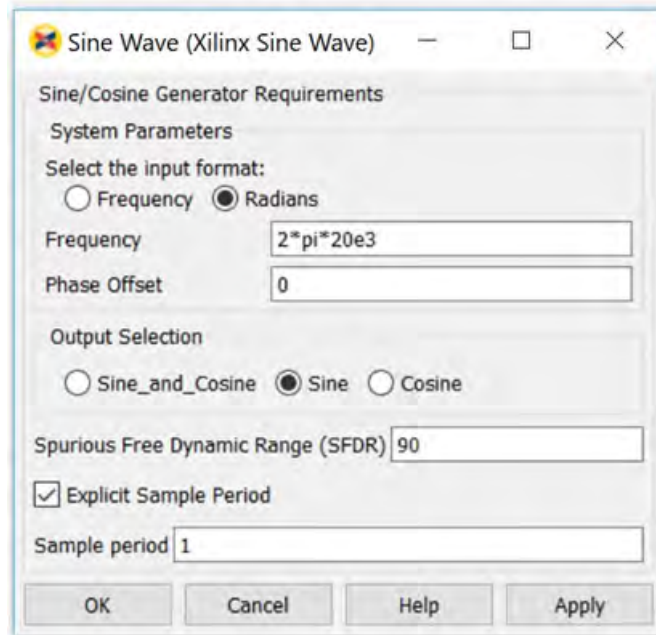

These settings generate this sine wave:

Figure 68: Sine Wave Settings

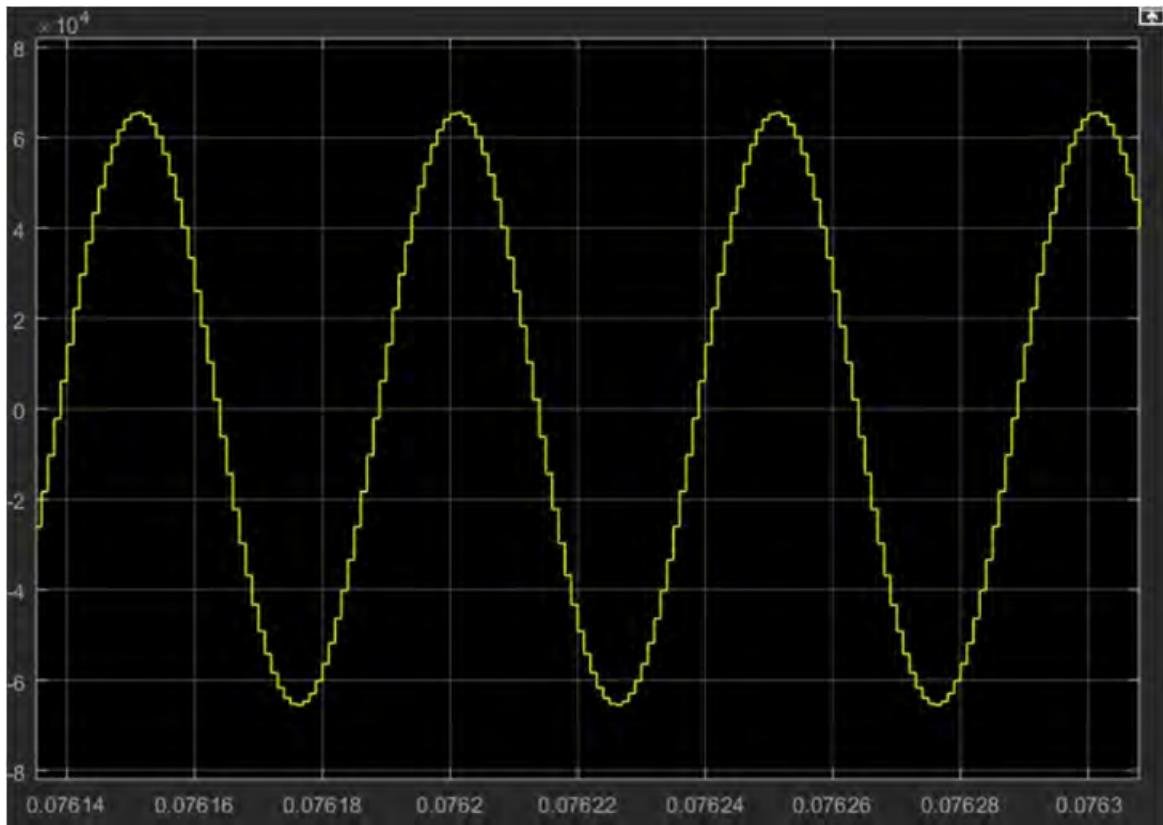

Wavelength of sine wave = *Simulink Sample Period / Frequency* => $1\text{MHz}/20\text{KHz} = 0.5 \times 10^{-4}$

The spectrum view of the sine wave is:

Figure 69: Sine Wave Output

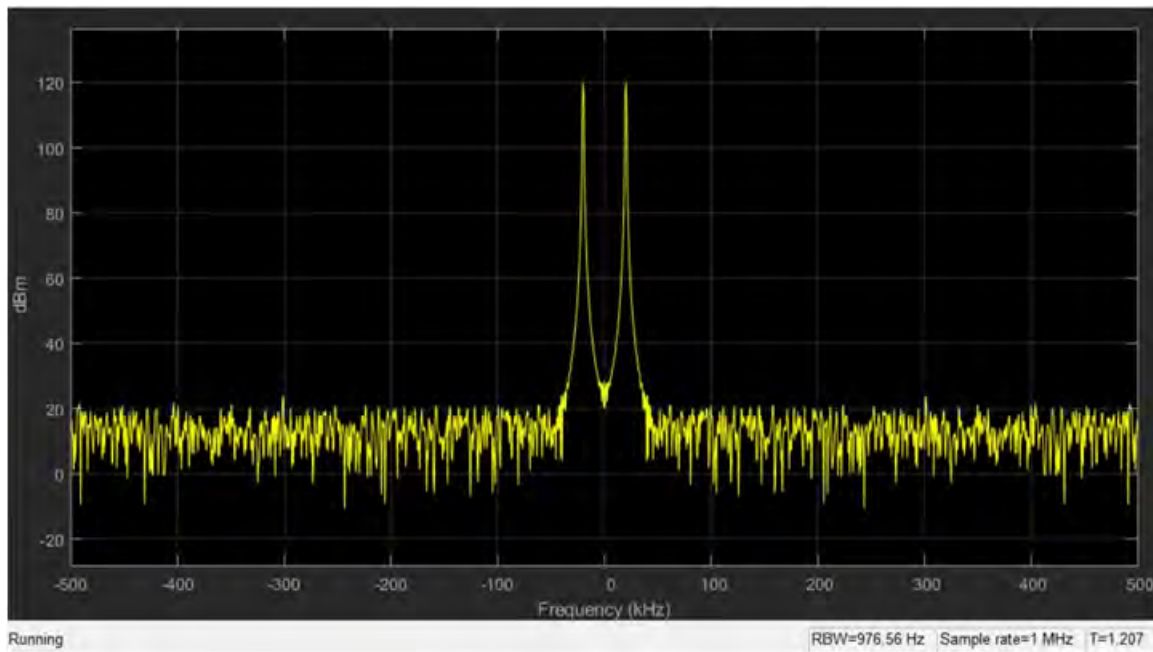

Also:

$$\text{Number of Samples per period} = (2\pi / (1/1e6 * 20e3))$$

$$= 50 \text{ (Total number of samples in a single cycle)}$$

$$\text{Number of offset samples} = (\pi/2) * (50/2\pi) = 50/4$$

LogiCORE Documentation

[LogiCORE IP DDS Compiler v6.0 Product Guide](#)

Single Port RAM

This block is listed in the following Xilinx® Blockset libraries: Control Logic, Floating-Point, Memory, and Index.

The Xilinx Single Port RAM block implements a random access memory (RAM) with one data input and one data output port.

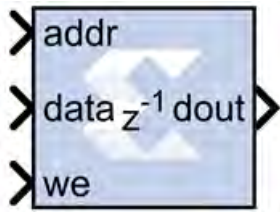

Block Interface

The block has one output port and three input ports for address, input data, and write enable (WE). Values in a Single Port RAM are stored by word, and all words have the same arithmetic type, width, and binary point position.

A single-port RAM can be implemented using either block memory, distributed memory, or UltraRAM resources in the FPGA. Each data word is associated with exactly one address that must be an unsigned integer in the range 0 to $d-1$, where d denotes the RAM depth (number of words in the RAM). An attempt to read past the end of the memory is caught as an error in the simulation, though if a block memory implementation is chosen, it can be possible to read beyond the specified address range in hardware (with unpredictable results). When the single-port RAM is implemented in distributed memory or block RAM, the initial RAM contents can be specified through the block parameters.

The write enable signal must be Bool, and when its value is 1, the data input is written to the memory location indicated by the address input. The output during a write operation depends on the choice of memory implementation.

The behavior of the output port depends on the write mode selected (see below). When the WE is 0, the output port has the value at the location specified by the address line.

Block Parameters

The block parameters dialog box can be invoked by double-clicking the icon in your Simulink® model.

- **Basic Tab:**

Parameters specific to the Basic tab are as follows.

- **Depth:** The number of words in the memory; must be a positive integer.
- **Initial value vector:**

The Initial value vector stores the initial contents of the memory. When the vector length exceeds the memory depth, values with index higher than depth are ignored. When the depth exceeds the vector length, memory locations with addresses higher than the vector length are initialized to zero. Initialization values are saturated and rounded (if necessary) according to the precision specified on the data port.

UltraRAM memory is initialized to all 0's during power up or device reset. If implemented in UltraRAM, the Single Port RAM block cannot be initialized to user defined values.

- **Memory Type:** Option to select whether the single-port RAM will be implemented using **Distributed memory, Block RAM, or UltraRAM.**

Depending on your selection for **Memory Type**, the single-port RAM will be inferred or implemented as follows when the design is compiled:

- If the block will be implemented in **Distributed memory**, the Distributed Memory Generator v8.0 LogiCORE IP will be inferred or implemented when the design is compiled. This LogiCORE IP is described in *Distributed Memory Generator LogiCORE IP Product Guide* ([PG063](#)).
- If the block will be implemented in block RAM or UltraRAM, the XPM_MEMORY_SDRAM (Single Port RAM) macro will be inferred or implemented when the design is compiled. For information on the XPM_MEMORY_SDRAM Xilinx Parameterized Macro (XPM), refer to *UltraScale Architecture Libraries Guide* ([UG974](#)).
- **Write Mode:** Specifies memory behavior when WE is asserted. Supported modes are: **Read after write**, **Read before write**, and **No read on write**. **Read after write** indicates the output value reflects the state of the memory after the write operation. **Read before write** indicates the output value reflects the state of the memory before the write operation. **No read on write** indicates that the output value remains unchanged irrespective of change of address or state of the memory. There are device specific restrictions on the applicability of these modes. Also refer to the Write Modes and Hardware Notes topics below for more information.
- **Provide reset port for output register:** For block RAM or UltraRAM, exposes a reset port controlling the output register of the RAM. This port does not reset the memory contents to the initialization value.

Note: For Block RAM or UltraRAM, the reset port is available only when the latency of the Block RAM is greater than or equal to 1.

- **Initial value for output register:**

for Block RAM, the initial value for the output register. The initial value is saturated and rounded as necessary according to the precision specified on the data port of the Block RAM.

For UltraRAM, the output register is initialized to all 0's. The UltraRAM output register cannot be initialized to user defined values.

Other parameters used by this block are explained in the [Common Options in Block Parameter Dialog Boxes](#) topic at the beginning of this chapter.

Write Modes

During a write operation (WE asserted), the data presented to the data input is stored in memory at the location selected by the address input. You can configure the behavior of the data out port A upon a write operation to one of the following modes:

- Read after write
- Read before write
- No read on write

These modes can be described with the help of the figure shown below. In the figure the memory has been set to an initial value of 5 and the address bit is specified as 4. When using **No read on write** mode, the output is unaffected by the address line and the output is the same as the last output when the WE was 0. For the other two modes, the output is obtained from the location specified by the address line, and hence is the value of the location being written to. This means that the output can be either the old value (**Read before write mode**), or the new value (**Read after write mode**).

Figure 70: Configuration for Read After Write

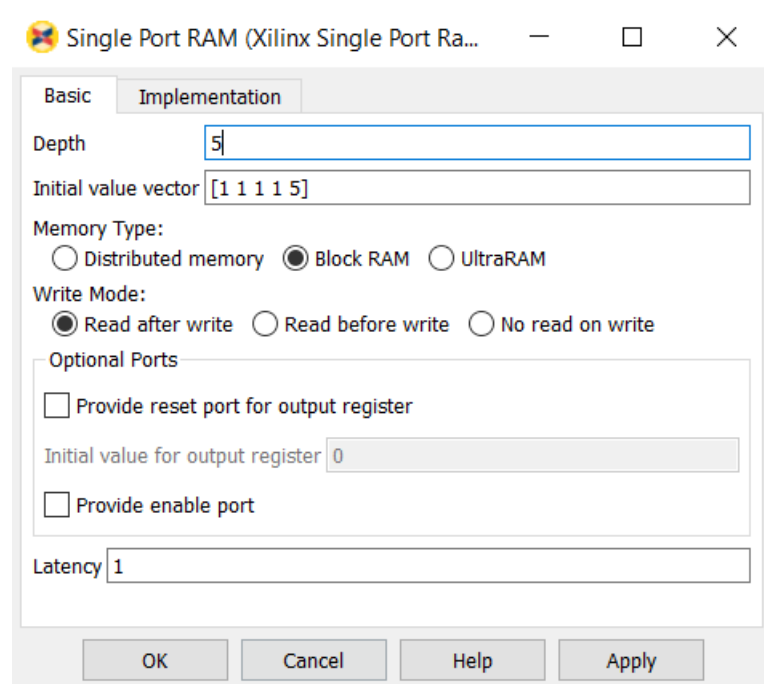
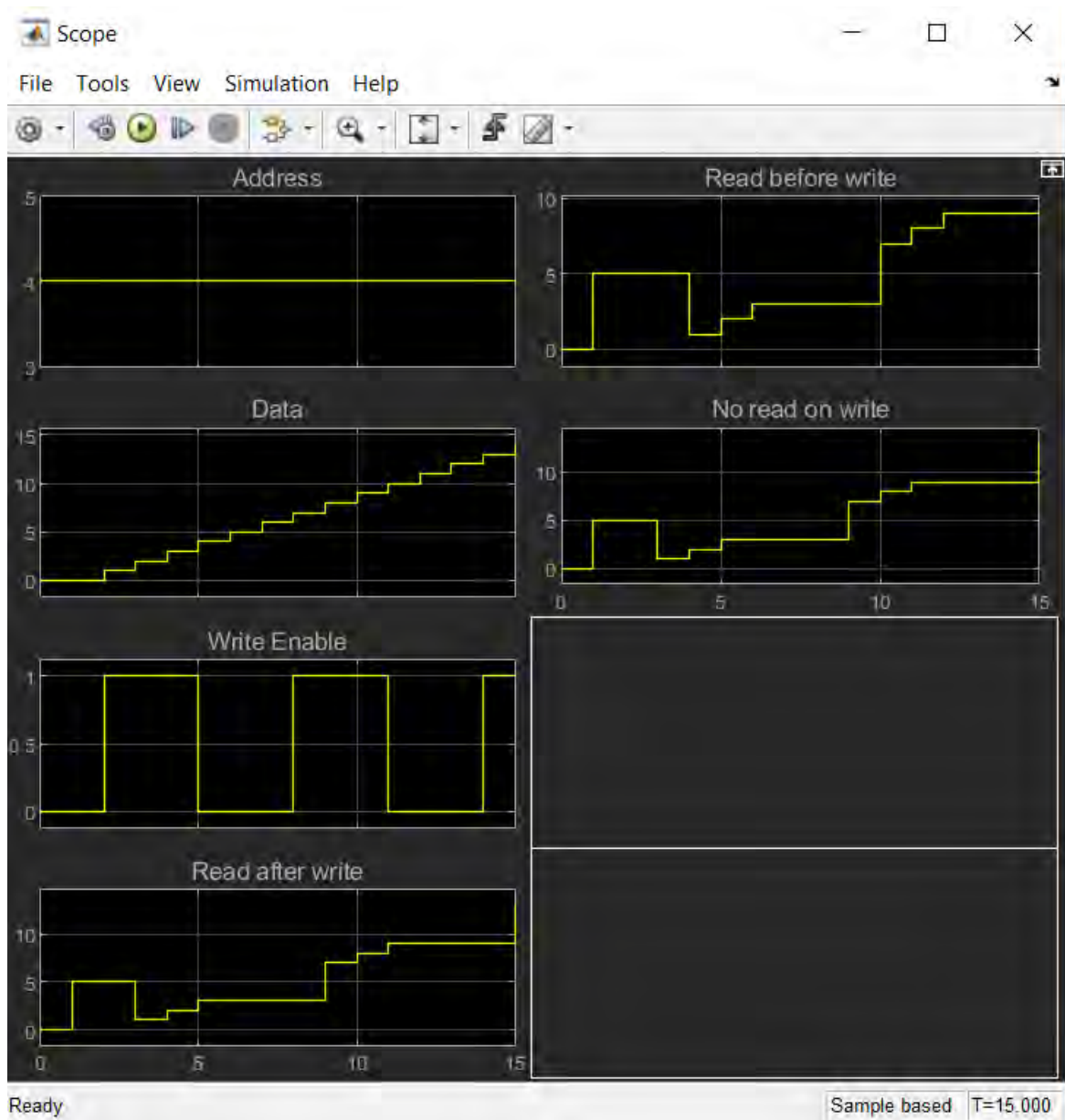

Figure 71: Write Output



Hardware Notes

The distributed memory LogiCORE™ supports only the **Read before write** mode. The Xilinx Single Port RAM block also allows distributed memory with **Write Mode** option set to **Read after write** when specified latency is greater than 0. The **Read after write** mode for the distributed memory is achieved by using extra hardware resources (a MUX at the distributed memory output to latch data during a write operation).

LogiCORE and XPM Documentation

[LogiCORE IP Distributed Memory Generator v8.0 \(Distributed Memory\)](#)

[UltraScale Architecture Libraries Guide - XPM_MEMORY_SPRAM Macro \(UltraRAM\)](#)

Slice

This block is listed in the following Xilinx® Blockset libraries: Basic Elements, Control Logic, Data Types, and Index.

The Xilinx Slice block allows you to slice off a sequence of bits from your input data and create a new data value. This value is presented as the output from the block. The output data type is unsigned with its binary point at zero.



The block provides several mechanisms by which the sequence of bits can be specified. If the input type is known at the time of parameterization, the various mechanisms do not offer any gain in functionality. If, however, a Slice block is used in a design where the input data width or binary point position are subject to change, the variety of mechanisms becomes useful. The block can be configured, for example, always to extract only the top bit of the input, only the integral bits, or only the first three fractional bits. The following diagram illustrates how to extract all but the top 16 and bottom 8 bits of the input.

Figure 72: Extracting Top 16 and Bottom 8 Bits

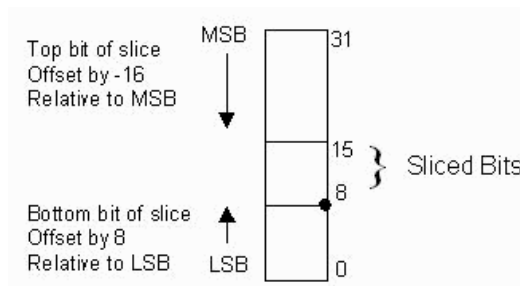

Block Parameters

The block parameters dialog box can be invoked by double-clicking the icon in your Simulink® model.

Parameters specific to the block are as follows.

- **Width of slice (Number of bits):** Specifies the number of bits to extract.
- **Boolean output:** Tells whether single bit slices should be type Boolean.
- **Specify range as:** (Two bit locations | Upper bit location + width | Lower bit location + width). Allows you to specify either the bit locations of both end-points of the slice or one end-point along with number of bits to be taken in the slice.
- **Offset of top bit:** Specifies the offset for the ending bit position from the LSB, MSB or binary point.
- **Offset of bottom bit:** Specifies the offset for the ending bit position from the LSB, MSB or binary point.
- **Relative to:** Specifies the bit slice position relative to the Most Significant Bit (MSB), Least Significant Bit (LSB), or Binary point of the top or the bottom of the slice.

Other parameters used by this block are explained in the topic [Common Options in Block Parameter Dialog Boxes](#).

SquareRoot

This block is listed in the following Xilinx® Blockset libraries: *Floating-Point, Math, and Index*.

The Xilinx SquareRoot block performs the square root on the input. Currently, only the floating-point data type is supported.

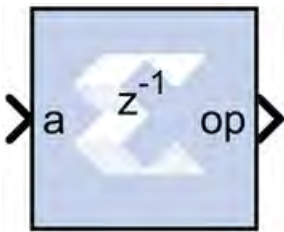

Block Parameters

The block parameters dialog box can be invoked by double-clicking the icon in your Simulink® model.

- **Basic tab:**

Parameters specific to the Basic tab are as follows.

- **Flow Control:**

- **Blocking:** Selects “Blocking” mode. In this mode, the lack of data on one input channel does block the execution of an operation if data is received on another input channel.

- **NonBlocking:** Selects “Non-Blocking” mode. In this mode, the lack of data on one input channel does not block the execution of an operation if data is received on another input channel.
- **Optional ports:**
 - **Input Channel Ports:**
 - **Has TLAST:** Adds a TLAST port to the Input channel.
 - **Has TUSER:** Adds a TUSER port to the Input channel.
 - **Provide enable port:** Adds an enable port to the block interface.
 - **Has Result TREADY:** Adds a TREADY port to the Result channel.
 - **Exception Signals:**
 - **INVALID_OP:** Adds an output port that serves as an invalid operation flag.

Other parameters used by this block are explained in the topic [Common Options in Block Parameter Dialog Boxes](#).

LogiCORE Documentation

[LogiCORE IP Floating-Point Operator v7.1](#)

System Generator

This token is listed in the following Xilinx® Blockset libraries: Basic Elements, Tools, and Index.

The System Generator token serves as a control panel for controlling system and simulation parameters, and it is also used to invoke the code generator for netlisting. Every Simulink® model containing any element from the Xilinx Blockset must contain at least one System Generator token. Once a System Generator token is added to a model, it is possible to specify how code generation and simulation should be handled.



Token Parameters

The parameters dialog box can be invoked by double-clicking the icon in your Simulink model.

- **Compilation tab:**

Parameters specific to the Compilation tab are as follows.

- **Board:**

Specifies a Xilinx, Partner, or Custom board you will use to test your design. You can specify a **Board** for any of the compilation targets you select with the **Compilation** setting described below (**IP Catalog**, **Hardware Co-Simulation**, **Synthesized Checkpoint**, or **HDL Netlist**). One limitation is that the Point-to-Point Ethernet **Hardware Co-Simulation** compilation target is only supported on a KC705 or VC707 board.

When you select a **Board**, the **Part** field displays the name of the Xilinx device on the selected **Board**, and this part name cannot be changed.

For a Partner board or a custom board to appear in the **Board** list, you must configure System Generator to access the board files that describe the board.

- **Part:** Defines the Xilinx FPGA or SoC part to be used. If you have selected a **Board**, the **Part** field will display the name of the Xilinx device on the selected **Board**, and this part name cannot be changed.

- **Compilation:**

Specifies the type of compilation result that should be produced when the code generator is invoked. The default compilation type is **IP Catalog**.

The **Settings** button is activated when one of these compilation types is selected:

- **IP Catalog compilation:** The **Settings** button brings up a dialog box that allows you to add a description of the IP that will be placed in the IP catalog.
- **Hardware Co-Simulation (JTAG) compilation:** The **Settings** button brings up a dialog box that allows you to use burst data transfers to speed up JTAG hardware co-simulation.
- **Hardware Co-Simulation (Point-to-point Ethernet) compilation:** The **Settings** button brings up a dialog box that allows you to use burst data transfers to speed up point-to-point Ethernet hardware co-simulation.
- **Hardware Description Language:** Specifies the HDL language to be used for compilation of the design. The possibilities are VHDL and Verilog.
- **VHDL library:** Specifies the name of VHDL work library for code generation. The default name is `xil_defaultlib`.
- **Use STD_LOGIC type for Boolean or 1 bit wide gateways:** If your design's Hardware Description Language (HDL) is VHDL, selecting this option will declare a Boolean or 1-bit port (Gateway In or Gateway Out) as a STD-LOGIC type. If this option is not selected, System Generator will interpret Boolean or 1-bit ports as vectors.

- **Target directory:** Defines where System Generator should write compilation results. Because System Generator and the FPGA physical design tools typically create many files, it is best to create a separate target directory, for example, a directory other than the directory containing your Simulink® model files.
- **Synthesis strategy:** Choose a Synthesis strategy from the pre-defined strategies in the drop-down list.
- **Implementation strategy:** Choose an Implementation strategy from the pre-defined strategies in the drop-down list.
- **Create interface document:**

When this box is checked and the Generate button is activated for netlisting, System Generator creates an HTM document that describes the design being netlisted. This document is placed in a “documentation” subfolder under the netlist folder.

Adding Designer Comments to the Generated Document: If you want to add personalized comments to the auto-generated document, follow this procedure.

1. As shown below, double click the Simulink canvas at the top level and add a comment that starts with **Designer Comments:**

Figure 73: Designer Comments

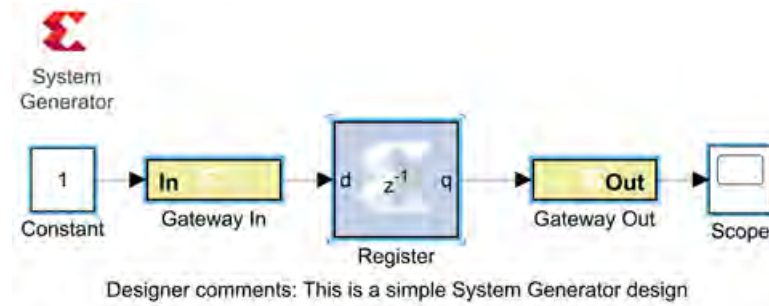

2. Double click on the System Generator token, click the **Create interface document** box at the bottom of the Compilation tab, then click **Generate**.
3. When netlisting is complete, navigate to the documentation subfolder underneath the netlist folder and double click on the HTM document. As shown below,
4. Designer Comments section is created in the document and your personalized comments are included.

- **Clock pin location:** Defines the pin location for the hardware clock. This information is passed to the Xilinx implementation tools through a constraints file. This option should not be specified if the System Generator design is to be included as part of a larger HDL design.
- **Provide clock enable clear pin:** This instructs System Generator to provide a `ce_clr` port on the top-level clock wrapper. The `ce_clr` signal is used to reset the clock enable generation logic. Capability to reset clock enable generation logic allows designs to have dynamic control for specifying the beginning of data path sampling.
- **Simulink system period (sec):** Defines the Simulink System Period, in units of seconds. The Simulink system period is the greatest common divisor of the sample periods that appear in the model. These sample periods are set explicitly in the block dialog boxes, inherited according to Simulink propagation rules, or implied by a hardware oversampling rate in blocks with this option. In the latter case, the implied sample time is in fact faster than the observable simulation sample time for the block in Simulink. In hardware, a block having an oversampling rate greater than one processes its inputs at a faster rate than the data. For example, a sequential multiplier block with an over-sampling rate of eight implies a (Simulink) sample period that is one eighth of the multiplier block's actual sample time in Simulink. This parameter can be modified only in a master block.
- **Perform analysis:** Specifies whether an analysis (timing or resource) will or will not be performed on the System Generator design when it is compiled. If **None** is selected, no timing analysis or resource analysis will be performed. If **Post Synthesis** is selected, the analysis will be performed after the design has been synthesized in the Vivado® toolset. If **Post Implementation** is selected, the analysis will be performed after the design is implemented in the Vivado toolset.
- **Analyzer type:** Two selections are provided: **Timing** or **Resource**. After generation is completed, a Timing Analyzer table or Resource Analyzer table is launched.
- **Launch analyzer:** Launches the Timing Analyzer or Resource Analyzer table, depending on the selection of **Analyzer type**. This will only work if you already ran analysis on the Simulink model and haven't changed the Simulink model since the last run.
- **General tab:**

Parameters specific to the General tab are as follows.

 - **Block icon display:** Specifies the type of information to be displayed on each block icon in the model after compilation is complete. The various display options are described below.
 - **Default:** Displays the default block icon information on each block in the model. A block's default icon is derived from the `xbsIndex` library.

Figure 75: Default Block Icon

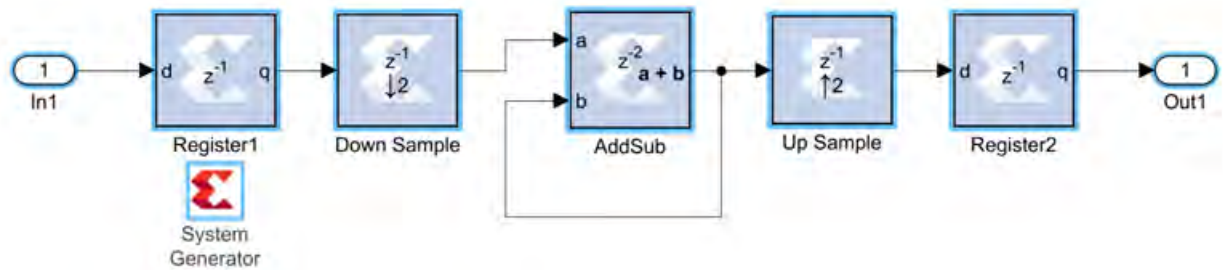

- Normalized Sample Periods:** Displays the normalized sample periods for all the input and output ports on each block. For example, if the Simulink System Period is set to 4 and the sample period propagated to a block port is 4 then the normalized period that is displayed for the block port is 1 and if the period propagated to the block port is 8 then the sample period displayed would be 2 for example, a larger number indicates a slower rate.

Figure 76: Normalized Sample Periods Icon

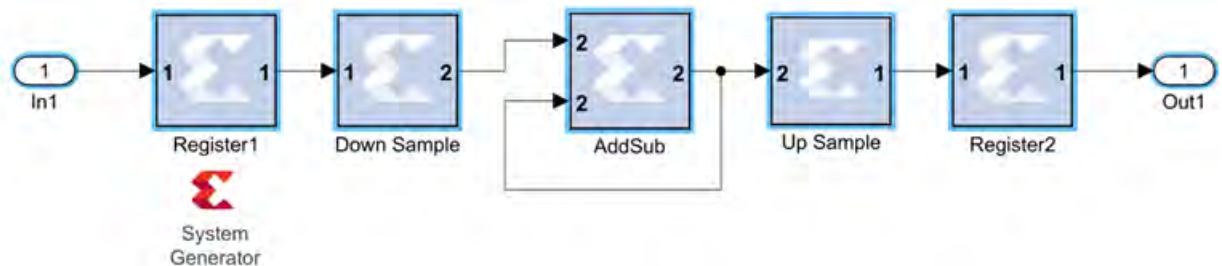

- Sample frequencies (MHz):** Displays sample frequencies for each block.
- Pipeline stages:** Displays the latency information from the input ports of each block. The displayed pipeline stage might not be accurate for certain high-level blocks such as the FFT, RS Encoder/ Decoder, Viterbi Decoder, etc. In this case the displayed pipeline information can be used to determine whether a block has a combinational path from the input to the output. For example, the Up Sample block in the figure below shows that it has a combinational path from the input to the output port.

Figure 77: Sample Frequencies

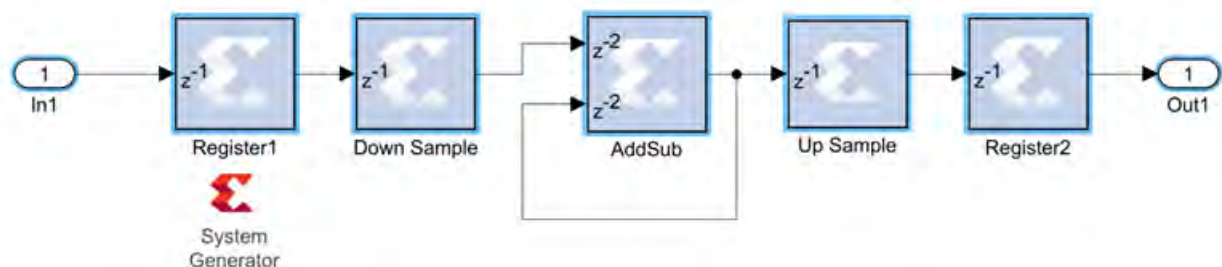

- **HDL port names:** Displays the HDL port name of each port on each block in the model.
- **Input data types:** Displays the data type of each input port on each block in the model.
- **Output data types:** Displays the data type of each output port on each block in the model.
- **Remote IP cache:**

If selected, your design will access an IP cache whenever a System Generator compilation performs Vivado synthesis as part of the compilation. If the compilation generates an IP instance for synthesis, and the Vivado synthesis tool generates synthesis output products, the tools create an entry in the cache area. If a new customization of the IP is created which has the exact same properties, the tools will copy the synthesis outputs from the cache to the design's output directory instead of synthesizing the IP instance again. Accessing the disk cache speeds up the iterative design process.

IP caching is described at [this link](#) in the Vivado Design Suite User Guide: Model-Based DSP Design Using System Generator (UG897).

- **Clear cache:** Clicking this button clears the remote IP cache. Clearing the cache saves disk space, because the IP Cache can grow large, especially if your design uses many IP modules.

Threshold

This block is listed in the following Xilinx® Blockset libraries: Basic Elements, Data Types, Math, and Index.

The Xilinx Threshold block tests the sign of the input number. If the input number is negative, the output of the block is -1; otherwise, the output is 1. The output is a signed fixed-point integer that is 2 bits long. The block has one input and one output.

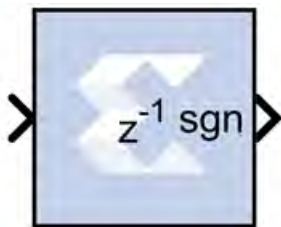

Block Parameters

The block parameters dialog box can be invoked by double-clicking the icon in your Simulink® model.

Parameters used by this block are explained in the topic [Common Options in Block Parameter Dialog Boxes](#).

The block parameters do not control the output data type because the output is always a signed fixed-point integer that is 2 bits long.

Xilinx LogiCORE

The Threshold block does not use a Xilinx LogiCORE™.

Time Division Demultiplexer

This block is listed in the following Xilinx® Blockset libraries: Basic Elements, and Index.

The Xilinx Time Division Demultiplexer block accepts input serially and presents it to multiple outputs at a slower rate.

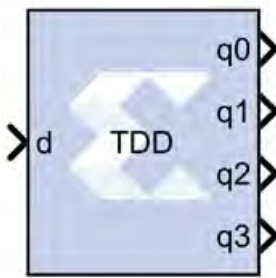

Block Interface

The block has one data input port and a user-configurable number of data outputs, ranging from 1 to 32. The data output ports have the same arithmetic type and precision as the input data port. The time division demultiplexer block also has optional input-valid port (vin) and output-valid port (vout). Both the valid ports are of type Bool.

For single channel implementation, the time division demultiplexer block has one data input and output port. Optional data valid input and output ports are also allowed. The length of the frame sampling pattern establishes the length of the input data frame. The position of 1 indicates the input value to be downsampled and the number of 1's correspond to the downsampling factor. The behavior of the demultiplexer block in single channel mode can best be illustrated with the help of the figure below. Based on the frame sampling pattern entered, the first and second input values of every input data frame are sampled and presented to the output at the rate of 2.

Figure 78: Single Channel Implementation

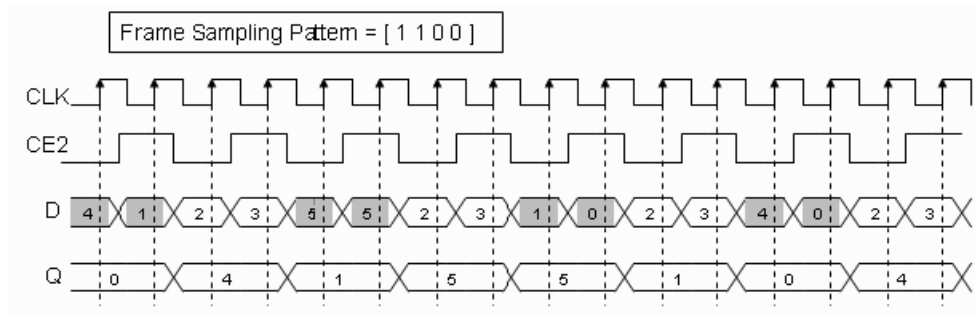

For single channel implementation, the number of values to be sampled from a data frame should evenly divide the size of the input frame. Every input data frame value can also be qualified by using the optional valid port.

Block Parameters

The block parameters dialog box can be invoked by double-clicking the icon in your Simulink® model.

Parameters specific to this block are as follows.

- **Frame sampling pattern:** Specifies the size of the serial input data frame. The frame sampling pattern must be a MATLAB® vector containing only 1's and 0's.
- **Implementation:** Specifies the demultiplexer behavior to be either in single or multiple channel mode. The behaviors of these modes are explained above.
- **Provide Valid Port:** When selected, the demultiplexer has optional input and output valid ports (vin / vout). The vin port allows to qualify every input data value as part of the serial input data frame. The vout port marks the state of the output ports as valid or not.

Parameters used by this block are explained in the topic [Common Options in Block Parameter Dialog Boxes](#).

Time Division Multiplexer

This block is listed in the following Xilinx® Blockset libraries: Basic Elements, and Index.

The Xilinx Time Division Multiplexer block multiplexes values presented at input ports into a single faster rate output stream.

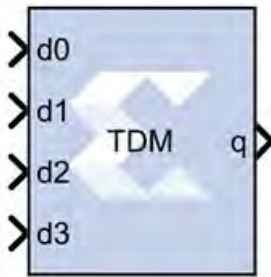

Block Interface

The block has two to 32 input ports and one output port. All input ports must have the same arithmetic type, precision, and rate. The output port has the same arithmetic type and precision as the inputs. The block has optional ports `vin` and `vout` that specify when input and output respectively are valid. Both valid ports are of type `Bool`.

Block Parameters

The block parameters dialog box can be invoked by double-clicking the icon in your Simulink® model.

Parameters specific to the block are as follows.

- **Number of inputs:** Specifies the number of inputs (2 to 32).
- **Provide valid port:** When selected, the multiplexer is augmented with input and output valid ports named `vin` and `vout` respectively. When the `vin` port indicates that input values are invalid, the `vout` port indicates the corresponding output frame is invalid.
- **Optimization Parameter:** The Time Division Multiplexer block logic can be implemented in fabric (optimizing for resource usage) or in DSP48E1/DSP48E2 primitives (optimizing for speed). The default is **Resource**.
- **Resource:** Use combinatorial fabric (general interconnect) to implement the Time Division Multiplexer in the Xilinx device.
- **Speed:** Use DSP48 primitives to implement the Time Division Multiplexer in the Xilinx device.

Parameters used by this block are explained in the topic [Common Options in Block Parameter Dialog Boxes](#).

Toolbar

This block is listed in the following Xilinx® Blockset libraries: Tools, and Index.

The Xilinx Toolbar block provides quick access to several useful utilities in System Generator. The Toolbar simplifies the use of the zoom feature in Simulink® and adds new auto layout and route capabilities to Simulink® models.



The Toolbar also houses several productivity improvement tools described below.

Block Interface

Double clicking on the Xilinx Toolbar block launches the GUI shown below.

Figure 79: Toolbar GUI









The Toolbar can also be launched from the command line using xITBUtiles, a collection of functions used by the Toolbar.

```
xITBUtiles('Toolbar');
```

Only one Toolbar GUI can be opened at a time, that is, the Toolbar GUI is a singleton. Regardless of where a Toolbar block is placed, the Toolbar will always perform actions on the current Simulink model in focus. In other words, if the Toolbar is invoked from model A, it can still be used on model B so long as model B is in focus.

- **Toolbar Buttons :**

Toolbar Buttons	Descriptions
	<p>Undo: Cancels the most recent change applied to the model layout by the Toolbar and reverts the layout state to the one prior to this change. Can undo up to three changes.</p>

Toolbar Buttons	Descriptions
	Reroute: Reroutes lines to enhance model readability. If lines are selected, only those lines are rerouted. Otherwise all lines in the model are rerouted.
	Auto Layout: Relocates blocks and reroutes lines to enhance model readability.
	Add Terms: Calls on the xlAddTerms function to add sources and sinks to the current model in focus. System Generator blocks are sourced with a System Generator constant block, while Simulink blocks are sourced with a Simulink constant block. Terminators are used as sinks.
	Help: Opens this document.
	Zoom: Allows you to get either a closer view of a portion of the Simulink model or a wider view of the model depending on the position of the slider or the value of the zoom factor. You can either position the slider or edit the Zoom Factor. The Zoom Factor is limited to be between 5 and 1000.

Toolbar Menus

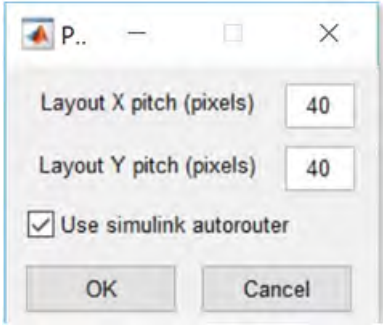
Toolbar Buttons	Descriptions
Tools	
Create Plugins	Launches the System Generator Board Description Builder tool.
Inspect Selected	Opens up the Simulink® Inspector with the properties of the blocks that are currently selected. This is useful when trying to set the size of several blocks, or the horizontal position of blocks drawn on a model.
Toolbar Properties	<p>Launches the Properties Dialog Box shown in the figure below. Allows you to set parameters for the Auto Layout and Reroute tool. X and Y pitch indicate distances (in pixels) between blocks placed next to each other in the X and Y directions respectively.</p> <p>The toolbar uses the Simulink autorouter when Use simulink autorouter is checked. Otherwise, a direct line is drawn from source to destination.</p> 
Help	Opens this document.

Note: This block is to be deprecated and will not be available in the library from the 2020.2 release.

References

- 1) E.R.Gansner, E.Koutsofios, S.C.North, KVo, "A Technique for Drawing Directed Graphs", <http://www.graphviz.org/Documentation/TSE93.pdf>
- 2) The **Reroute** and **Auto Layout** buttons invoke an open source package called Graphviz. More information on this package is also available at <http://www.graphviz.org/>

Up Sample

This block is listed in the following Xilinx® Blockset libraries: Basic Elements, and Index.

The Xilinx Up Sample block increases the sample rate at the point where the block is placed in your design. The output sample period is $1/n$, where l is the input sample period, and n is the sampling rate.

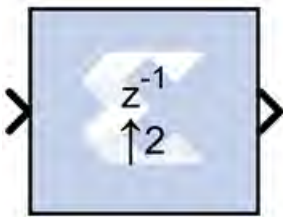

The input signal is up sampled so that within an input sample frame, an input sample is either presented at the output n times if samples are copied, or presented once with $(n-1)$ zeroes interspersed if zero padding is used.

In hardware, the Up Sample block has two possible implementations. If the Copy Samples option is selected on the block parameters dialog box, the Din port is connected directly to Dout and no hardware is expended. Alternatively, if zero padding is selected, a mux is used to switch between the input sample and inserted zeros. The corresponding circuit for the zero padding Up Sample block is shown below.

Figure 80: Zero Padding Up Sample Circuit

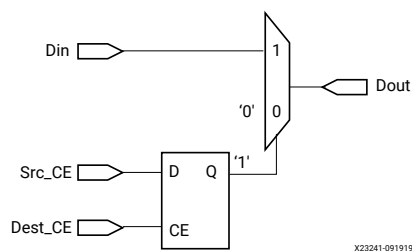

Block Interface

The Up Sample block receives two clock enable signals, Src_CE and Dest_CE. Src_CE is the clock enable signal corresponding to the input data stream rate. Dest_CE is the faster clock enable, corresponding to the output data stream rate. Notice that the circuit uses a single flip-flop in addition to the mux. The flip-flop is used to adjust the timing of Src_CE, so that the mux switches to the data input sample at the start of the input sample period, and switches to the constant zero after the first input sample. It is important to notice that the circuit has a combinational path from Din to Dout. As a result, an Up Sample block configured to zero pad should be followed by a register whenever possible.

Figure 81: Up Sample Output

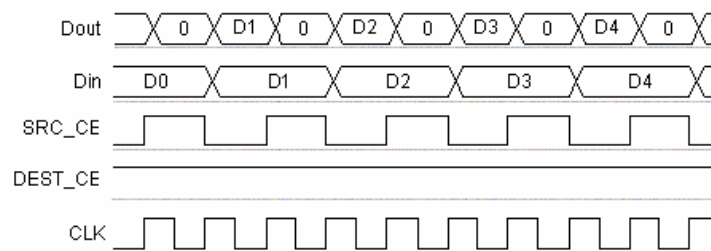

Block Parameters

The block parameters dialog box can be invoked by double-clicking the icon in your Simulink® model.

- **Basic tab:**

Parameters specific to the Basic tab are as follows.

- **Sampling rate (number of output samples per input sample):** Must be an integer with a value of 2 or greater. This is the ratio of the output sample period to the input, and is essentially a sample rate multiplier. For example, a ratio of 2 indicates a doubling of the input sample rate. If a non-integer ratio is desired, the Up Sample block can be used in combination with the Down Sample block.
- **Copy samples (otherwise zeros are inserted):** Allows you to choose what to do with the additional samples produced by the increased clock rate. By selecting Copy Samples, the same sample is duplicated (copied) during the extra sample times. If this checkbox is not selected, the additional samples are zero.
- **Provide enable port:** When checked, this option adds an en (enable) input port, if the Latency is specified as a positive integer greater than zero.

- Latency:** This defines the number of sample periods by which the block's output is delayed. One sample period can correspond to multiple clock cycles in the corresponding FPGA implementation (for example, when the hardware is over-clocked with respect to the Simulink® model). The user defined sample latency is handled in the Upsample block by placing shift registers that are clock enabled at the input sample rate, on the input of the block. The behavior of an Upsample block with non-zero latency is similar to putting a delay block, with equivalent latency, at the input of an Upsample block with zero latency.

Parameters used by this block are explained in the topic [Common Options in Block Parameter Dialog Boxes](#).

Viterbi Decoder 9.1

This block is listed in the following Xilinx® Blockset libraries: AXI4, Communications, and Index.

Note: This block goes into the FPGA fabric and is a Licensed Core. Please visit the Xilinx web site to purchase the appropriate core license.

Data encoded with a convolution encoder can be decoded using the Xilinx Viterbi decoder block. This block adheres to the AXI4-Stream standard.

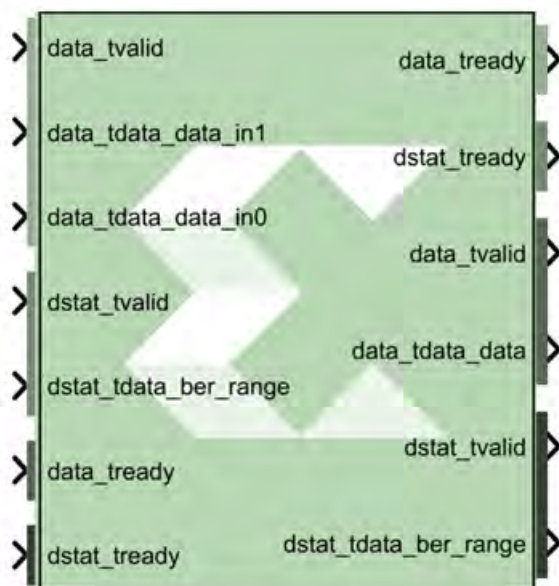

There are two steps to the decode process. The first weighs the cost of incoming data against all possible data input combinations; either a Hamming or Euclidean metric can be used to determine the cost. The second step traces back through the trellis and determines the optimal path. The length of the trace through the trellis can be controlled by the traceback length parameter.

The decoder achieves minimal error rates when using optimal convolution codes; the table below shows various optimal codes. For correct operation, convolution codes used for encoding must match with that for decoding.

Table 22: Convolution Codes

Constraint Length	Optimal Convolution Codes for 1/2 rate (octal)	Optimal Convolution Codes for 1/3 Rate (octal)
3	[7 5]	[7 7 5]
4	[17 13]	[17 13 15]
5	[37 33]	[37 33 25]
6	57 65]	[57 65 71]
7	[117 127]	[117 127 155]
8	[357 233]	[357 233 251]
9	[755 633]	[755 633 447]

Block Interface

The Xilinx Viterbi Decoder 9.1 block is AXI4 compliant. The following describes the standard AXI channels and pins on the interface.

- **S_AXIS_DATA Channel:**

- **s_axis_data_tvalid:** TVALID for S_AXIS_DATA channel. Input pin, always available. This port indicates the values presents on the input data ports are valid.
- **s_axis_data_tready:** TREADY for S_AXIS_DATA. Output pin, always available. This port indicates that the core is ready to accept data.
- **s_axis_data_tdata:** Input TDATA. Different input data ports are available depending on the Viterbi Type selected on Page1 tab of block-GUI.

When Trellis Mode is selected, 5 input data pins become available – these are **s_axis_data_tdata_tcm00**, **s_axis_data_tdata_tcm01**, **s_axis_data_tdata_tcm10**, **s_axis_data_tdata_tcm11** and **s_axis_data_tdata_sector**.

The width of the Trellis mode inputs (**s_axis_data_tdata_tcm****) can range from 4 to 6 corresponding to a data width (Soft_Width value on Page2 tab) of 3 to 5. **s_axis_data_tdata_sector** is always 4-bit wide. The decoder always functions as a rate 1/2 decoder when Trellis mode is selected.

For any other Viterbi Type (Standard/Multi-Channel/Dual Decoder), the Decoder supports rates from 1/2 to 1/7. Therefore, the block can have 2 to 7 input data ports labeled **s_axis_data_tdata_data_in0** **s_axis_data_tdata_data_in6**. Hard Coding requires each **tdata_data_in<n>** port to be 1 bit wide. Soft Coding allows these widths to be between 3 to 5 bits (inclusive).

- **s_axis_data_tuser:** TUSER for S_AXIS_DATA. These ports are only present if External Puncturing is selected or it is a Dual Decoder or Block Valid signal is used with the core.
- **s_axis_data_tuser_erase:** Port becomes available, when External Puncturing is selected (on Page2 tab). This input bus is used to indicate the presence of a null-symbol on the corresponding data_in buses. For e.g. tuser_erase(0) corresponds to data_in0, tuser_erase(1) corresponds to data_in1 etc. If an erase bit is high, the data on the corresponding data_in bus is treated as a null-symbol internally to the decoder. The width of the erase bus is equal to the output rate of the decoder with a maximum value of 7.
- **s_axis_data_tuser_sel:** Port becomes available when Dual Decoder is selected. This is used to select the correct set of convolution codes for the decoding of the input data symbols in the dual decoder case. When SEL is low, the input data is decoded using the first set of convolution codes. When it is high, the second set of convolution codes is applied.
- **s_axis_data_tuser_block_in:** Port becomes available when Block Valid option is selected on Page 5 tab.
- **M_AXIS_DATA Channel:**
 - **m_axis_data_tvalid:** TVALID for M_AXIS_DATA channel. Output pin, always available. It indicates whether the output data is valid or not.
 - **m_axis_data_tready:** TREADY for M_AXIS_DATA channel. Do not enable or tie high if downstream slave is always able to accept data. It becomes available when TREADY option is selected on Page 5 tab.
 - **m_axis_data_tdata:** Decoded TDATA for output data channel.
 - **m_axis_data_tdata_data:** Port represents the decoded output data and it is always 1 bit wide.
 - **m_axis_data_tdata_sector:** Port becomes available for Trellis Mode decoder. This port is always 4-bit wide. The output SECTOR is a delayed version of the input SECTOR bus. Both buses have a fixed width of 4 bits. The delay equals the delay through the Trellis Mode decoder.
 - **m_axis_data_tuser:** TUSER for M_AXIS_DATA channel. These ports are only present if the block is a Dual Decoder or it has normalization signal present or it has Block Valid option checked.
 - **m_axis_data_tuser_sel:** Port becomes available when the block is configured as a Dual Decoder. This signal is a delayed version of the input s_axis_data_tuser_sel signal. The delay equals to the delay through the Dual Decoder.
 - **m_axis_data_tuser_norm:** Port becomes available when NORM option is checked on Page 5 tab. This port indicates when normalization has occurred within the core. It gives an immediate indication of the rate of errors in the channel.

- **m_axis_data_tuser_block_out:** Port becomes available when Block Valid option is checked on Page 5 tab. This signal is a delayed version of the input s_axis_data_tuser_block_in signal. The BLOCK_OUT signal shows the decoded data corresponding to the original BLOCK_IN set of data points. The delay equals the delay through the decoder.
- **S_AXIS_DSTAT Channel:**

Note: These ports become available when Use BER Symbol Count is selected on Page 5 tab.

 - **s_axis_dstat_tvalid:** TVALID for S_AXIS_DSTAT channel.
 - **s_axis_dstat_tready:** TREADY for S_AXIS_DSTAT channel. Indicates that the core is ready to accept data. Always high, except after a reset if there is not a TREADY on the output.
 - **s_axis_dstat_tdata_ber_range:** TDATA for S_AXIS_DSTAT channel. This is the number of symbols over which errors are counted in the BER block.
- **M_AXIS_DSTAT Channel:**

Note: These ports become available when Use BER Symbol Count is selected on Page 5 tab.

 - **m_axis_dstat_tvalid:** TVALID for M_AXIS_DSTAT channel.
 - **m_axis_dstat_tready:** TREADY for M_AXIS_DSTAT channel. Do not enable or tie high if downstream slave is always able to accept data. It becomes available when TREADY option is selected on Page 5 tab.
 - **m_axis_dstat_tdata_ber:** TDATA for M_AXIS_DSTAT channel. The Bit Error Rate (BER) bus output (fixed width 16) gives a measurement of the channel bit error rate by counting the difference between the re-encoded DATA_OUT and the delayed DATA_IN to the decoder.
- **Other Optional Pins:**
 - **aresetn:** The synchronous reset (aresetn) input can be used to re-initialize the core at any time, regardless of the state of aclken signal. aresetn needs to be asserted low for at least two clock cycles to initialize the circuit. This pin becomes available if ARESETN option is selected on the Page 5 tab. It must be of type Bool. If this pin is not selected, System Generator ties this pin to inactive (high) on the core.
 - **aclken:** Carries the clock enable signal for the decoder. The signal driving aclken must be Bool. This pin becomes available if ACLKEN option is selected on Page 5 tab.

Block Parameters

- **Page1 tab:**

Parameters specific to the Page1 tab are as follows.

- **Viterbi Type:**

- **Number of Channels:** Used with the Multi-Channel selection, the number of channels to be decoded can be any value between 2 and 32.
- **Standard:** This type is the basic Viterbi Decoder.
- **Multi-Channel:** This type allows many interlaced channels of data to be decoded using a single Viterbi Decoder.
- **Trellis Mode:** This type is a trellis mode decoder using the TCM and SECTOR_IN inputs.
- **Dual Decoder:** When selected, the block behaves as a dual decoder with two sets of convolutional codes. This makes the sel input port available.
- **Decoder Options:**
 - **Use Reduced Latency:** The latency of the block depends on the traceback length and the constraint length. If this reduced latency option is selected, then the latency of the block is approximately halved and the latency is only 2 times the traceback length.
 - **Constraint length:** Equals $n+1$, where n is the length of the constraint register in the encoder.
 - **Traceback length:** Length of the traceback through the Viterbi trellis. Optimal length is 5 to 7 times the constraint length.
- **Page2 tab:**
 - **Architecture:**
 - **Parallel:** Large but fast Viterbi Decoder.
 - **Serial:** Small but processes the input data in a serial fashion. The number of clock cycles needed to process each set of input symbols depends on the output rate and the soft width of the data.
 - **Best State:**
 - **Use Best State:** Gives improved BER performance for highly punctured data.
 - **Best State Width:** Indicates how many of the least significant bits to ignore when saving the cost used to determine the best state.
 - **Puncturing:**
 - **None:** Input data has not been punctured.
 - **External (Erased Symbols):** When selected an erase port is added to the block. The presence of null-symbols (that is, symbols which have been deleted prior to transmission across the channel) is indicated using the erasure input erase.
 - **Coding:**

- **Soft Width:** The input width of soft-coded data can be anything in the range 3 to 5. Larger widths require more logic. If the block is implemented in serial mode, larger soft widths also increase the serial processing time.
- **Soft Coding:** Uses the Euclidean metric to cost the incoming data against the branches of the Viterbi trellis.
- **Hard Coding:** Uses the Hamming difference between the input data bits and the branches of the Viterbi trellis. Hard coding is only available for the standard parallel block.
- **Data Format:**
 - **Signed Magnitude:**
 - **Offset Binary (available for soft coding only):**

See Table 1 in the associated LogiCORE™ Product Specification for the Signed Magnitude and Offset-Binary data format for Soft Width 3.

- **Page3 tab:**
 - **Convolution 0:**
 - **Output Rate 0:** Output Rate 0 can be any value from 2 to 7.
 - **Convolution Code 0 Radix:** The convolutional codes can be input and viewed in binary, octal, or decimal.
 - **Convolution Code Array (0-6):** First array of convolution codes. Output rate is derived from the array length. Between 2 and 7 (inclusive) codes can be entered. When dual decoding is used, a value of 0 (low) on the sel port corresponds to this array.

- **Page4 tab:**

The options on this tab are activated when you select **Dual Decoder** as the Viterbi Type on the Page1 tab.

- **Convolution 1:**
 - **Output Rate 1:** Output Rate 1 can be any value from 2 to 7. This is the second output rate used if the decoder is dual. The incoming data is decoded at this rate when the SEL input is high. Output Rate 1 is not used for the non-dual decoder.
 - **Convolution Code 1 Radix:** The convolutional codes can be input and viewed in binary, octal, or decimal.
- **Page5 tab:**
 - **BER Options:**

- **Use BER Symbol Count:** This bit-error-rate (BER) option monitors the error rate on the transmission channel.
- **Optional Pins:**
 - **NORM:** Indicates when normalization has taken place internal to the Add Compare Select module.
 - **Block Valid:** Check this box if BLOCK_IN and BLOCK_OUT signals are required. These signals track the movement of a block of data through the decoder. BLOCK_OUT corresponds to BLOCK_IN delayed by the decoder latency.
 - **TREADY:** Selecting this option makes m_axis_data_tready and m_axis_dstat_tready pins available on the block.
 - **ACLKEN:** Carries the clock enable signal for the block The signal driving acken must be Bool.
 - **ARESETN:** Adds a aresetn pin to the block. This signal resets the block and must be of type Bool. aresetn must be asserted low for at least 2 clock periods and at least 1 sample period before the decoder can start decoding code symbols.

Common Parameters used by this block, such as **Display shortened port names**, are explained in the topic [Common Options in Block Parameter Dialog Boxes](#).

LogiCORE Documentation

[LogiCORE IP Viterbi Decoder v9.1](#)

Vitis HLS

This block is listed in the following Xilinx® Blockset libraries: Control and Index.

The Xilinx Vitis™ HLS block allows the functionality of a Vitis HLS design to be included in a System Generator design. The Vitis HLS design can include C, C++ and System C design sources.



There are two steps to the method of including a Vitis HLS design into System Generator. The first step is to use the Vitis HLS RTL Packaging feature to package the design files into a Solution directory. (Refer to Vitis HLS documentation for more information regarding RTL Packaging.) The second step is to place the Vitis HLS block in your System Generator design and specify the Vitis HDL Solution directory as the target.

Block Parameters Dialog Box

Figure 82: Block Parameters Dialog Box

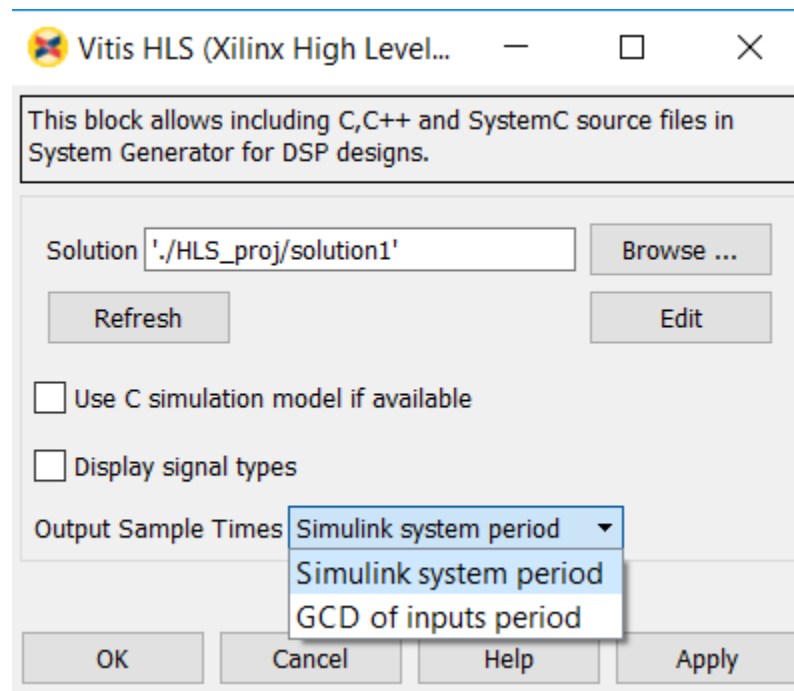

- **Solution:** The path to the Solution space directory containing RTL packaged for System Generator. This path is usually the path to a directory contained in a Vivado® HLS project. The path must be included in single quotes and must evaluate to a string.
- **Browse:** A standard directory browse button.
- **Refresh:** Updates the block ports to the latest package contained in the solution space.
- **Edit:** Opens the Vitis HLS project associated with solution space.
- **Use C simulation model if available:** Use the C simulation model if it is available in the Vitis HLS package. As shown below, the simulation model being used is shown on the Vitis HLS block. In this case, an RTL-model is used because a C simulation model is not available.
- **Display signal types:** Signal types to be used to drive input ports and emanating from output ports are displayed on the block icon when checked.
- **Output Sample Times:** Select either the **Simulink system period** or the **GCD of the inputs period**.

Data Type Translation

Data Type Translation	
C/C++ Data Type	System Generator for DSP Data Type
float	XFloat_32_23
double	XFloat_64_52
bool	UFix_1_0
(unsigned) char	(U)Fix_8_0
(unsigned) short	(U)Fix_16_0
(unsigned) int	(U)Fix_32_0
(unsigned) long	(U)FIX_<PlatformDependent>_0
(unsigned) long long	(U)Fix_64_0
ap_(u)fix<N,M>	(U)Fix_<N>_<N-M>
ap_(u)int<N>	(U)Fix_N_0

Known Issues

- It is not possible to include a purely combinational design from Vitis HLS. The design must synthesize into an RTL design that contains a Clock and a Clock Enable input.
- The top-level module cannot contain C/C++ templates.
- Composite ports will be represented as UFix_<N>_0 only where N is the width of the port.
- The current C simulation model only supports fixed latency and interval designs. The latency and interval numbers are obtained from the synthesis engine.
- The current C simulation model supports the default block-level communication protocol (ap_hs).
- The current C simulation model does not support the 'ap_memory' and 'ap_bus' interfaces.
- The System Generator Vitis HLS block does not support combinational designs due to performance considerations. In the current implementation, System Generator updates each HLS input port multiple times every clock cycle. So it is very costly to evaluate the DUT whenever inputs changes.
- The output values match RTL simulation results only when corresponding control signals indicate data are valid. So test bench and downstream blocks should read/observe data based on the communication protocol and control signals.
- Because the Vitis HLS block has to use the GCC shipped in the Vivado Design Suite to compile dll on Win-64 platform, users cannot use arbitrary bitwidth integers in C designs on win-64 systems.

Xilinx SSR Blockset

Scalar2Vector

The Scalar2Vector block converts scalar type input to vector type output.

Description

The Xilinx® Scalar2Vector block slices the binary value of the input scalar based on the Width parameter to produce a vector output. For example, if the input is 3720 (binary value 111 010 001 000) of type `Ufix_12_0`, SSR is 4, and the Width parameter value is 3, then this block slices the input binary value into 4 groups, each of 3 bits, so that it produces the output [0 1 2 7].

Data Type Support

The input must be a Boolean or unsigned fixed-point signal. The output type is normally unsigned with binary point at zero, but can be Boolean when the Width parameter is 1.



Block Parameters

Width: This parameter defines the number of bits for each element of output vector. This parameter is decided by:

$$\text{Width} = \text{Input data width (bits)} / \text{SSR}$$

This formula must be satisfied when setting up the block parameters.

Super Sample Rate (SSR): This configurable GUI parameter is primarily used to control the processing of multiple data samples on every sample period. This block enables 1-D vector support for the primary block operation.

Vector Absolute

The Vector Absolute block outputs the absolute value of the input of vector type.

Description

Super Sample Rate (SSR): This configurable GUI parameter is primarily used to control the processing of multiple data samples on each sample period. This block enables 1-D vector support for the primary block operation.



Block Parameters

Double-click the icon in your Simulink® model to open the Block Parameters dialog box.

- **Basic tab :**

- **Precision:**

This parameter allows you to specify the output precision for fixed-point arithmetic. Floating-point arithmetic output will always be **Full** precision.

- **Full:** The block uses sufficient precision to represent the result without error.
 - **User Defined:** If you do not need full precision, this option allows you to specify a reduced number of total bits and/or fractional bits.

- **Fixed-point Output Type:**

Arithmetic type:

- **Signed (2's comp):** The output is a Signed (2's complement) number.
 - **Unsigned:** The output is an Unsigned number.

- **Fixed-point Precision:**

- **Number of bits:** Specifies the bit location of the binary point of the output number, where bit zero is the least significant bit.
 - **Binary point:** Position of the binary point. in the fixed-point output.

- **Quantization:**

Refer to the section [Overflow and Quantization](#).

- **Overflow:**

Refer to the section [Overflow and Quantization](#).

Other parameters used by this block are explained in the topic [Common Options in Block Parameter Dialog Boxes](#).

LogiCORE Documentation

[LogiCORE IP Floating-Point Operator v7.1](#)

Vector AddSub Fabric

The Vector Adder/Subtractor Fabric block supports the Addition/Subtraction operation for inputs of vector type.

Description

Super Sample Rate (SSR): This configurable GUI parameter is primarily used to control processing of multiple data samples on each sample period. This blocks enable 1-D vector support for the primary block operation.

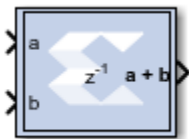

Block Parameters

Double-click the icon in your Simulink® model to open the block parameters dialog box.

- **Basic tab:**

Parameters specific to the Basic tab are as follows:

- **Operation:** Specifies the block operation to be Addition, Subtraction, or Addition/Subtraction. When Addition/Subtraction is selected, the block operation is determined by the sub input port, which must be driven by a Boolean signal. When the sub input is 1, the block performs subtraction. Otherwise, it performs addition.
- **Optional Ports:**

- **Provide carry-in port:** When selected, allows access to the carry-in port, `cin`. The carry-in port is available only when **User defined** precision is selected and the binary point of the inputs is set to zero.
- **Provide carry-out port:** When selected, allows access to the carry-out port, `cout`. The carry-out port is available only when **User defined** precision is selected, the inputs and output are unsigned, and the number of output integer bits equals x , where $x = \max$ (integer bits a , integer bits b).
- **Latency:** The **Latency** value defines the number of sample periods by which the block's output is delayed. One sample period might correspond to multiple clock cycles in the corresponding FPGA implementation (for example, when the hardware is over-clocked with respect to the Simulink model). System Generator does not perform extensive pipelining unless you select the **Pipeline for maximum performance** option (on the Implementation tab, described below); additional latency is usually implemented as a shift register on the output of the block.
- **Output tab:**
 - **Precision:**

This parameter allows you to specify the output precision for fixed-point arithmetic. Floating point arithmetic output will always be **Full** precision.

 - **Full:** The block uses sufficient precision to represent the result without error.
 - **User Defined:** If you do not need full precision, this option allows you to specify a reduced number of total bits and/or fractional bits.
 - **User-Defined Precision:**
 - **Fixed-point Precision:**
 - **Signed (2's comp):** The output is a Signed (2's complement) number.
 - **Unsigned:** The output is an Unsigned number.
 - **Number of bits:** Specifies the bit location of the binary point of the output number, where bit zero is the least significant bit.
 - **Binary point:** Position of the binary point. in the fixed-point output.
 - **Quantization:** Refer to the section [Overflow and Quantization](#).
 - **Overflow:** Refer to the section [Overflow and Quantization](#).
- **Implementation tab:**

Parameters specific to the Implementation tab are as follows:

- **Use behavioral HDL (otherwise use core):** The block is implemented using behavioral HDL. This gives the downstream logic synthesis tool maximum freedom to optimize for performance or area.

Note: For Floating-point operations, the block always uses the Floating-point Operator core.

- **Core Parameters:**

- **Implement using:** Core logic can be implemented in **Fabric** or in a **DSP48**, if a DSP48 is available in the target device. The default is **Fabric**.

- **Pipeline for maximum performance:**

The XILINX LogiCORE™ can be internally pipelined to optimize for speed instead of area. Selecting this option puts all user defined latency into the core until the maximum allowable latency is reached. If the **Pipeline for maximum performance** option is *not* selected and latency is greater than zero, a single output register is put in the core and additional latency is added on the output of the core.

The **Pipeline for maximum performance** option adds the pipeline registers throughout the block, so that the latency is distributed, instead of adding it only at the end. This helps to meet tight timing constraints in the design.

Other parameters used by this block are explained in the topic [Common Options in Block Parameter Dialog Boxes](#).

LogiCORE Documentation

[LogiCORE IP Adder/Subtractor v12.0](#)

[LogiCORE IP Floating-Point Operator v7.1](#)

Vector Assert

The Vector Assert block asserts a user-defined sample rate and/or type on Vector inputs.

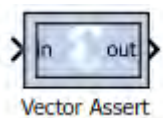

Hardware notes: in hardware this blocks costs nothing.

Description

Super Sample Rate (SSR): Use this configurable GUI parameter to control processing of multiple data samples on every sample period. This block enables 1-D vector data support for the primary block operation.

Block Parameters

The block parameters dialog box can be invoked by double-clicking the icon in your Simulink® model.

Parameters specific to this block are as follows:

- **Type:**
 - **Assert type:** Specifies whether or not the block will assert that the type at its input is the same as the type specified. If the types are not the same, an error message is reported. This block is listed in the following Xilinx Blockset libraries: Floating-Point and Index.
 - **Specify type:** Specifies whether or not the type to assert is provided from a signal connected to an input port named type or whether it is specified **Explicitly** from parameters in the Assert block dialog box.
 - **Output Type:** Specifies the data type of the output. Can be **Boolean**, **Fixed-point**, or **Floating-point**.
 - **Arithmetic Type:** If the Output Type is specified as Fixed-point, you can select **Signed (2's comp)** or **Unsigned** as the Arithmetic Type.
 - **Fixed-point Precision:**
 - **Number of bits:** Specifies the bit location of the binary point of the output number, where bit zero is the least significant bit.
 - **Binary point:** Position of the binary point in the fixed-point output.
 - **Floating-point Precision:**
 - **Single:** Specifies single precision (32 bits).
 - **Double:** Specifies double precision (64 bits).
 - **Custom:** This block is listed in the following: Activates the field below so you can specify the Exponent width and the Fraction width.
 - **Exponent width:** Specify the exponent width.
 - **Fraction width:** Specify the fraction width.
- **Rate:**

- **Assert rate:** specifies whether or not the block will assert that the rate at its input is the same as the rate specified. If the rates are not the same, an error message is reported.
- **Specify rate:** Specifies whether or not the initial rate to assert is provided from a signal connected to an input port named `rate`, or whether it is specified **Explicitly** from the **Sample rate** parameter in the Assert block dialog box.
- **Provide output port:** Specifies whether or not the block will feature an output port. The type and/or rate of the signal presented on the output port is the type and/or rate specified for assertion.

Other parameters used by this block are explained in the topic [Common Options in Block Parameter Dialog Boxes](#).

The **Output type** parameter in this block uses the same description as the Arithmetic Type described in the topic [Common Options in Block Parameter Dialog Boxes](#).

The Vector Assert block does not use a Xilinx LogiCORE™ and does not use resources when implemented in hardware.

Vector Complex Mult

The Vector Complex Multiplier block supports multiplication of two complex input vectors.

Description

Super Sample Rate (SSR): This configurable GUI parameter is primarily used to control processing of multiple data samples on every sample period. This blocks enable 1-D vector support for the primary block operation.

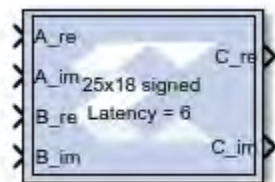

Data Type Support

- Supports fixed and floating-point data type inputs on both port A and B.
- The number of bits on Input port A should be greater than or equal to 26.
- The number of bits on Input port B should be greater than or equal to 17.

Vector Concat

The Vector Concat block concatenates two or more inputs of type vector. The output is cast to an unsigned value with the binary point at zero.

Description

Super Sample Rate (SSR): This configurable GUI parameter is primarily used to control processing of multiple data samples on every sample period. This block enables 1-D vector data support for the primary block operation.



The [Vector Reinterpret](#) block provides capabilities that can extend the functionality of the Vector Concat block.

Block Interface

The block has n input ports, where n is a value between 2 and 1024, inclusively, and one output port. The first and last input ports are labeled `hi` and `low`, respectively. Input ports between these two ports are not labeled. The input to the `hi` port occupies the most significant bits of the output, and the input to the `low` port occupies the least significant bits of the output.

Block Parameters

Double-click the icon in your Simulink® model to open the Block Parameter dialog box.

Parameters specific to this block are as follows:

- **Number of Inputs:** Specifies number of inputs, between 2 and 1024, inclusively, to concatenate together.

Other parameters used by this block are explained in the topic [Common Options in Block Parameter Dialog Boxes](#).

The Vector Concat block does not use a Xilinx LogiCORE™.

Vector Constant

The Vector Constant Block generates vector constant values.

Description

Super Sample Rate (SSR): This configurable GUI parameter is primarily used to control processing of multiple data samples on every sample period. This block enables 1-D vector data support for the primary block operation.

The Vector Constant block generates a constant that can be a fixed-point value, a Boolean value, or a DSP48 instruction. This block is similar to the Simulink® Vector Constant block, but can be used to directly drive the inputs on Xilinx blocks.



Block Parameters

Open the Block Parameters dialog box by double-clicking the icon in your Simulink model.

- **Basic tab:**

Parameters specific to the Basic tab are as follows:

- **Constant Value:**

Specifies the value of the constant. When changed, the new value appears on the block icon. If the constant data type is specified as fixed-point and cannot be expressed exactly in the specified fixed-point type, its value is rounded and saturated as needed. A positive value is implemented as an unsigned number, a negative value as signed.

- **Output Type:** Specifies the data type of the output.

- Boolean
- Fixed-point
- Floating-point

- **Arithmetic Type:** If the Output Type is specified as Fixed-point.

- Signed (2's comp)
- Unsigned
- DSP48 instruction

- **Fixed-point Precision:**
 - **Number of bits:** Specifies the bit location of the binary point of the output number, where bit zero is the least significant bit.
 - **Binary point:** Position of the binary point. in the fixed-point output.
- **Floating-point Precision:**
 - **Single:** Specifies single precision (32 bits).
 - **Double:** Specifies double precision (64 bits).
 - **Custom:** Activates the field below so you can specify the Exponent width and the Fraction width.
 - **Exponent width:** Specifies the exponent width.
 - **Fraction width:** Specifies the fraction width.
- **Sample Period:**
 - **Sampled Constant:** Allows a sample period to be associated with the constant output and inherited by blocks that the constant block drives. (This is useful mainly because the blocks eventually target hardware and the Simulink sample periods are used to establish hardware clock periods.)

Other parameters used by this block are explained in the topic [Common Options in Block Parameter Dialog Boxes](#)

Vector Convert

The Vector Convert block supports Data Type Conversion feature for vector type inputs.

Hardware notes: Rounding and saturating require hardware resources; truncating and wrapping do not.

Description

Super Sample Rate (SSR): This configurable GUI parameter is primarily used to control processing of multiple data samples on every sample period. This blocks enable 1-D vector data support for the primary block operation.

The Vector Convert block converts each input sample to a number of a desired arithmetic type. For example, a number can be converted to a signed (two's complement) or unsigned value.

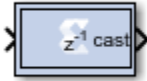

Block Parameters

Open the Block Parameters dialog box by double-clicking the icon in your Simulink® model.

- **Basic tab:**

Parameters specific to the Basic Tab are as follows:

- **Output Type:**

- Specify the output data type.
 - **Boolean**
 - **Fixed-point**
 - **Floating-point**

- **Arithmetic Type:** If the Output Type is specified as fixed-point, you can select Signed (two's comp) or Unsigned.

- **Fixed-point Precision:**

- **Number of bits:** Specifies the bit location of the binary point, where bit zero is the least significant bit
- **Binary point:** Specifies the bit location of the binary point, where bit zero is the least significant bit.

- **Floating-point Precision:**

- **Single:** Specifies single precision (32 bits).
- **Double:** Specifies double precision (64 bits).
- **Custom:** Activates the field below so you can specify the Exponent width and the Fraction width.
- **Exponent width:** Specify the exponent width.
- **Fraction width:** Specify the fraction width.

- **Quantization:**

Quantization errors occur when the number of fractional bits is insufficient to represent the fractional portion of a value. The options are to **Truncate** (for example, to discard bits to the right of the least significant representable bit), or to **Round(unbiased: +/- inf)** or **Round (unbiased: even values)**.

Round(unbiased: +/- inf) also known as "Symmetric Round (towards +/- inf)" or "Symmetric Round (away from zero)". This is similar to the MATLAB `round()` function. This method rounds the value to the nearest desired bit away from zero and when there is a value at the midpoint between two possible rounded values, the one with the larger magnitude is selected. For example, to round 01.0110 to a Fix_4_2, this yields 01.10, since 01.0110 is exactly between 01.01 and 01.10 and the latter is further from zero.

Round (unbiased: even values) also known as "Convergent Round (toward even)" or "Unbiased Rounding". Symmetric rounding is biased because it rounds all ambiguous midpoints away from zero which means the average magnitude of the rounded results is larger than the average magnitude of the raw results. Convergent rounding removes this by alternating between a symmetric round toward zero and symmetric round away from zero. That is, midpoints are rounded toward the nearest even number. For example, to round 01.0110 to a Fix_4_2, this yields 01.10, since 01.0110 is exactly between 01.01 and 01.10 and the latter is even. To round 01.1010 to a Fix_4_2, this yields 01.10, since 01.1010 is exactly between 01.10 and 01.11 and the former is even.

- **Overflow:**

Overflow errors occur when a value lies outside the representable range. For overflow the options are to **Saturate** to the largest positive/smallest negative value, to **Wrap** (for example, to discard bits to the left of the most significant representable bit), or to **Flag as error** (an overflow as a Simulink error) during simulation. **Flag as error** is a simulation only feature. The hardware generated is the same as when **Wrap** is selected.

- **Optional Ports:**

Provide enable port: Activates an optional enable (en) pin on the block. When the enable signal is not asserted the block holds its current state until the enable signal is asserted again or the reset signal is asserted.

- **Latency:**

The **Latency** value defines the number of sample periods by which the block's output is delayed. One sample period might correspond to multiple clock cycles in the corresponding FPGA implementation (for example, when the hardware is over-clocked with respect to the Simulink model). System Generator will not perform extensive pipelining unless you select the **Pipeline for maximum performance** option (described below); additional latency is usually implemented as a shift register on the output of the block.

- **Implementation tab:**

Parameters specific to the Implementation tab are as follows:

- **Performance Parameters:**
 - **Pipeline for maximum performance:**

The Xilinx LogiCORE™ can be internally pipelined to optimize for speed instead of area. Selecting this option puts all user defined latency into the core until the maximum allowable latency is reached. If the **Pipeline for maximum performance** option is *not* selected and latency is greater than zero, a single output register is put in the core and additional latency is added on the output of the core.

The **Pipeline for maximum performance** option adds the pipeline registers throughout the block, so that the latency is distributed, instead of adding it only at the end. This helps to meet tight timing constraints in the design.

Other parameters used by this block are explained in the topic [Common Options in Block Parameter Dialog Boxes](#).

LogiCORE Documentation

[LogiCORE IP Floating-Point Operator v7.1](#)

Vector DDFS

The Vector DDFS block generates Real and Imaginary vector output signals of desired frequency.

Description

The input port *I* is used for providing the desired output frequency value as a vector type.

The input port *I* value should be equal to:

$$(\text{desired output Frequency} * \text{Sampling time} * 2^{(\text{Frequency Resolution})})$$

The *VI* input port and *VO* output are used for synchronization purposes with the other blocks in the design. The *VO* is just a delayed version of *VI* based on the block latency. The *DITH* input port is used to turn on/off the phase noise dithering feature. The *CONJ* input port is set to '1' to conjugate the complex exponential output. The output ports, *O_RE* and *O_IM*, generate Real and Imaginary components of the desired vector output frequency signal.



Data Type Support

- The input port I should be a signed fixed-point data type.
- The input port VI, DITH, and CONJ should be Boolean data types.

Block Parameters

- **Super Sample Rate (SSR):**

This configurable GUI parameter is primarily used to control the processing of multiple data samples on every sample period. This block enables 1-D vector support for the primary block operation.

- **Frequency Resolution (bits):**

Defines the smallest incremental step in frequency that the block can output. This should be an integer value.

- **Sin/Cos Table Depth:**

Defines the depth of the Sin/Cos Table and should be an integer value.

- **Sin/Cos Table Width:**

Defines the width of the Sin/Cos Table and should be an integer value.

Vector Delay

The Vector Delay block supports delay operation on vector type inputs.

Hardware notes: A delay line is a chain, each link of which is an SRL16 followed by a flip-flop.

Description

Super Sample Rate (SSR): This configurable GUI parameter is primarily used to control processing of multiple data samples on every sample period. This block enables 1-D vector support for the primary block operation.

The Vector Delay block implements a fixed delay of L cycles.



The delay value is displayed on the block in the form z^{-L} , which is the *Z-transform* of the block's transfer function. Any data provided to the input of the block will appear at the output after L cycles. The rate and type of the data of the output is inherited from the input. This block is used mainly for matching pipeline delays in other portions of the circuit. The delay block differs from the register block in that the register allows a latency of only 1 cycle and contains an initial value parameter. The Vector Delay block supports a specified latency, but no initial value other than zeros. The figure below shows the Vector Delay block behavior when $L=4$ and $\text{Period}=1\text{s}$.

Figure 83: Vector Delay block behavior when $L=4$ and $\text{Period}=1\text{s}$

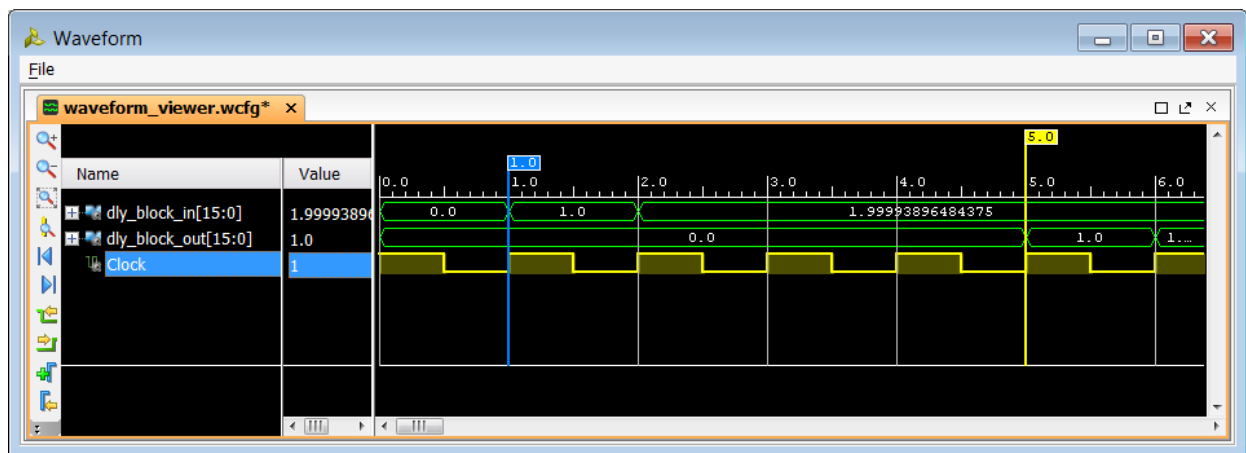

For delays that need to be adjusted during run-time, you should use the Addressable Shift Register block. Delays that are not an integer number of clock cycles are not supported and such delays should not be used in synchronous design (with a few rare exceptions).

Block Parameters

Open the Block Parameters dialog box by double-clicking the icon in your Simulink® model.

- **Basic tab:**

Parameters specific to the Basic tab are as follows:

- **Optional Ports:**

- **Provide synchronous reset port:** Activates an optional reset (*rst*) pin on the block. When the reset signal is asserted the block goes back to its initial state. Reset signal has precedence over the optional enable signal available on the block. The reset signal has to run at a multiple of the block's sample rate. The signal driving the reset port must be Boolean.

- Provide enable port:** Activates an optional enable (en) pin on the block. When the enable signal is not asserted the block holds its current state until the enable signal is asserted again or the reset signal is asserted. Reset signal has precedence over the enable signal. The enable signal has to run at a multiple of the block 's sample rate. The signal driving the enable port must be Boolean.
- Latency:** Latency is the number of cycles of delay. The latency can be zero, provided that the **Provide enable port** check box is not checked. The latency must be a non-negative integer. If the latency is zero, the Vector Delay block collapses to a wire during logic synthesis. If the latency is set to $L=1$, the block will generally be synthesized as a flip-flop (or multiple flip-flops if the data width is greater than 1).
- Implementation tab:**

Parameters specific to the Implementation tab are as follows:

 - Implement using behavioral HDL:** Uses behavioral HDL as the implementation. This allows the downstream logic synthesis tool to choose the best implementation.

Other parameters used by this block are explained in the topic [Common Options in Block Parameter Dialog Boxes](#).

Logic Synthesis using Behavioral HDL

This setting is recommended if you are using Synplify Pro as the downstream logic synthesis tool. The logic synthesis tool will implement the delay as it desires, performing optimizations such as moving parts of the delay line back or forward into blockRAMs, DSP48s, or embedded IOB flip-flops; employing the dedicated SRL cascade outputs for long delay lines based on the architecture selected; and using flip-flops to terminate either or both ends of the delay line based on path delays. Using this setting also allows the logic synthesis tool, if sophisticated enough, to perform retiming by moving portions of the delay line back into combinational logic clouds.

Logic Synthesis using Structural HDL

If you do not check the **Implement using behavioral HDL** box, then structural HDL is used. This is the default setting and results in a known, but less-flexible, implementation which is often better for use with Vivado® synthesis. In general, this setting produces structural HDL comprising an SRL (Shift-Register LUT) delay of $(L-1)$ cycles followed by a flip-flop, with the SRL and the flip-flop getting packed into the same slice. For a latency greater than $L=33$, multiple SRL/flip-flop sets are cascaded, albeit without using the dedicated cascade routes. For example, the following is the synthesis result for a 1-bit wide Vector Delay block with a latency of $L=64$.

Vector Delay Delta

The Vector Delay Delta Block delays each vector element differently based on the given latency and delay latency values.

Hardware notes: A delay line is a chain, each link of which is an SRL16 followed by a flip-flop.

Description

The delta latency parameter is used to generate each parallel path with different latency (for example, $[\text{Latency} + \text{Delta Latency} * (i-1)]$, where i represents the channel number in a range from 1 to the SSR value).

The delta latency should be an integer and greater than or equal to $-\text{Latency}/(\text{SSR}-1)$.

For example when SSR is set to '4', Latency is set to '1', and Delta Latency is set to '3' then the four channels from 1 to 4 are delayed by 1,4,7, and 10 sample times respectively.

Note: In the Vector Delay Delta block, all the parallel channels are delayed by an equal number of sample times provided by Latency parameter.

The Vector Delay Delta block implements a fixed delay of L cycles.



Block Parameters

Super Sample Rate (SSR): This configurable GUI parameter is primarily used to control processing of multiple data samples on every sample period. This blocks enable 1-D vector and/or complex data support for the primary block operation.

See the Xilinx® [Vector Delay](#) block for further information on using this block.

Vector Down Sample

The Vector Down Sample block down samples input vector data.

Hardware notes: Sample and Latency controls determine the hardware implementation. The cost in hardware of different implementations varies considerably.

Description

Super Sample Rate (SSR): This configurable GUI parameter is primarily used to control processing of multiple data samples on every sample period. This blocks enable 1-D vector support for the primary block operation.

The Vector Down Sample block reduces the sample rate at the point where the block is placed in your design.



The input signal is sampled at even intervals, at either the beginning (first value), or end (last value) of a frame. The sampled value is presented on the output port and held until the next sample is taken.

A Vector Down Sample frame consists of I input samples, where I is sampling rate. An example frame for a Vector Down Sample block configured with a sampling rate of 4 is shown below.

Figure 84: Vector Down Sample with Sampling Rate of 4

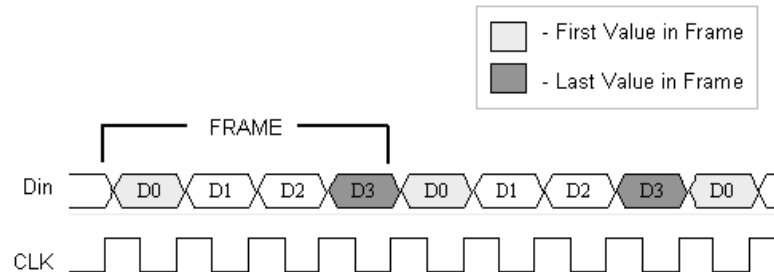

The Vector Down Sample block is realized in hardware using one of three possible implementations that vary in terms of implementation efficiency. The block receives two clock enable signals in hardware, `Src_CE`, and `Dest_CE`. `Src_CE` is the faster clock enable signal and corresponds to the input data stream rate. `Dest_CE` is the slower clock enable, corresponding to the output stream rate, for example, down sampled data. These enable signals control the register sampling in hardware.

Zero Latency Vector Down Sample

The zero latency Vector Down Sample block must be configured to sample the first value of the frame. The first sample in the input frame passes through the mux to the output port. A register samples this value during the first sample duration and the mux switches to the register output at the start of the second sample of the frame. The result is that the first sample in a frame is present on the output port for the entire frame duration. This is the least efficient hardware implementation as the mux introduces a combinational path from Din to Dout. A single bit register adjusts the timing of the destination clock enable, so that it is asserted at the start of the sample period, instead of the end. The hardware implementation is shown below.

Figure 85: Zero Latency Vector Down Sample

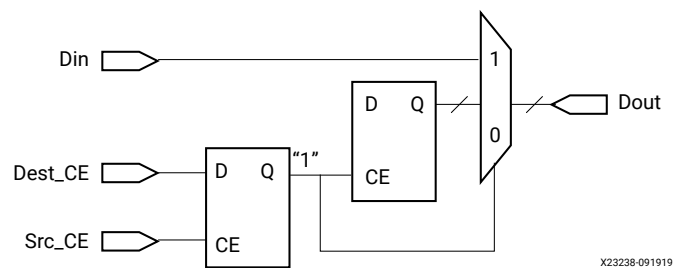

Vector Down Sample with Latency

If the Vector Down Sample block is configured with latency greater than zero, a more efficient implementation is used. One of two implementations is selected depending on whether the Vector Down Sample block is set to sample the first or last value in a frame.

If the block samples the first value in a frame, two registers are required to correctly sample the input stream. The first register is enabled by the adjusted clock enable signal so that it samples the input at the start of the input frame. The second register samples the contents of the first register at the end of the sample period to ensure output data is aligned correctly.

Figure 86: Two Register Example

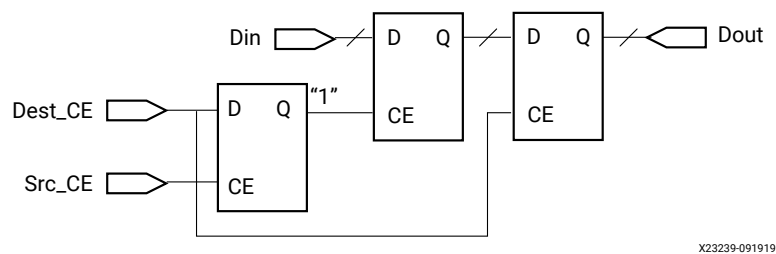

If the block samples the last value in a frame, a register samples the data input data at the end of the frame. The sampled value is presented for the duration of the next frame. The most efficient implementation is used when the Vector Down Sample block is configured to sample the last value of the frame.

Figure 87: One Register Example

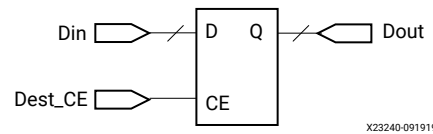

Block Parameters

The block parameters dialog box can be invoked by double-clicking the icon in your Simulink® model.

- **Basic tab:**

Basic tab parameters are as follows.

- **Sampling Rate (number of input samples per output sample):** Must be an integer greater or equal to 2. This is the ratio of the output sample period to the input, and is essentially a sample rate divider. For example, a ratio of 2 indicates a 2:1 division of the input sample rate. If a non-integer ratio is desired, the Vector Up Sample block can be used in combination with the Vector Down Sample block.
- **Sample:** The Vector Down Sample block can sample either the first or last value of a frame. This parameter will determine which of these two values is sampled.

Other parameters used by this block are explained in the topic [Common Options in Block Parameter Dialog Boxes](#).

Xilinx LogiCORE

The Vector Down Sample block does not use a Xilinx® LogiCORE™.

Vector FFT

The Vector FFT block supports the FFT operation for vector type inputs.

Description

The real part of the input data should be given to the `in_re` port, and the imaginary part should be given to the `in_im` port.

When the `in_valid` is high it indicates that the input data is valid. When `out_valid` is high, it indicates that the output data is valid. The `in_scale` input port is used if scaling is required. And `out_scale` is used in if there is an internal overflow.

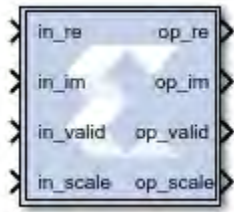

Data Type Support

- The number of `in_scale` bits must be equal to $\log_2(\text{FFT length})$.
- `in_valid` and `out_valid` are of Boolean data type.

Block Parameters

FFT length (N) is the size of the transformation, and should be powers of 2 in the range of 2^3 to 2^{16} . SSR is the super sample rate, the number of samples processed in parallel every clock. Using a typical example with $N=1024$ and $SSR=4$, the core would compute one 1K FFT every 256 clock cycles, processing 4 input samples/clock.

The fixed-point output data size must be 27 bits or less, this is limited by the DSP48 multiplier A port size.

BRAM_THRESHOLD is an implementation parameter with no functional implications, it controls the use of distributed RAM vs BRAM when implementing delay lines. It can be used to trade utilization numbers between these two types of resources. The higher the value, the more distributed RAM will be used instead of BRAM. Typical values to try are 258, 514, and 1026.

- **Scaling Ports:**

The scaling ports are called SI and SO. Their width matches the FFT size N, it is always $\log_2(N)$. There is one SI bit for every add/subtract stage, where internal overflows can occur. If that bit is set to zero then no scaling happens and bit growth is addressed by increasing the internal data sizes bit, one bit every stage. If the bit is set to 1 then the stage divides by 2, and no internal data growth is required to prevent overflows.

Generally, if the output data size is $\log_2(N)$ bits larger than the input size, no scaling is required, and SI is set to all zeros. If the input and output data sizes are equal, then scaling on every stage is needed and SI should be set to all ones. In reality, scaling is data dependent and some combination of output size growth and non-zero SI bits are used. If partial scaling is used, the non-zero bits of SI should be the MSB ones. SI should be static, it should not change while data is being processed by the core (when VI is high).

Another important requirement to avoid internal overflows is to have one MSB margin bit at the data inputs, that is the two MSBs of I.RE and I.IM should be the same. This prevents overflows in complex multipliers. If the two rules outlined above are followed, then internal overflows are impossible by design.

The SO port is an indicator of internal overflows, it is not normally used, only attach an unsigned signals of size $\log_2(N)$ to it.

Vector FIR

The Vector FIR block supports FIR filtering for vector type inputs.

Description

Super Sample Rate (SSR): This configurable GUI parameter is primarily used to control processing of multiple data samples on every sample period. This blocks enable 1-D vector support for the primary block operation.

- If the filter type is Interpolation, the output vector size (SSR value on the output side) is equal to the SSR value on the input side multiplied by Interpolation Rate Value.
- If the filter type is Decimation, the output vector size is equal to the SSR value on the input side divided by Decimation Rate Value.

This Vector FIR Compiler block provides a way to generate highly parameterizable, area-efficient, high-performance FIR filters with an AXI4-Stream-compliant interface.

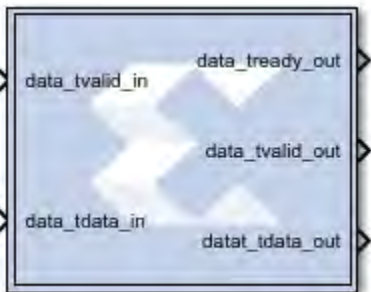

AXI Ports that are Unique to this Block

This block exposes the AXI CONFIG channel as a group of separate ports based on sub-field names. The sub-field ports are described as follows:

Configuration Channel Input Signals:

config_tdata_fsel	A sub-field port that represents the fsel field in the Configuration Channel vector. fsel is used to select the active filter set. This port is exposed when the number of coefficient sets is greater than one. Refer to the FIR Compiler V7.2 Product Guide starting on page 5 for an explanation of the bits in this field.
-------------------	--

Block Parameters

Open the block parameters dialog box by double-clicking the icon in your Simulink® model.

- **Filter Specification tab:**

Parameters specific to the Filter Specification tab are as follows:

- **Filter Coefficients:**

- **Coefficient Vector:** Specifies the coefficient vector as a single MATLAB row vector. The number of taps is inferred from the length of the MATLAB row vector. If multiple coefficient sets are specified, then each set is appended to the previous set in the vector. It is possible to enter these coefficients using the [FDA Tool](#) block as well.
- **Number of Coefficients Sets:** The number of sets of filter coefficients to be implemented. The value specified must divide without remainder into the number of coefficients.
- **Use Reloadable Coefficients:** Check to add the coefficient reload ports to the block. The set of data loaded into the reload channel will not take action until triggered by a re-configuration synchronization event. Refer to the [FIR Compiler V7.2 Product Guide](#) for a more detailed explanation of the RELOAD Channel interface timing. This block supports the `xlGetReloadOrder` function. See the System Generator Utility function `xlGetReloadOrder` for details.

- **Filter Specification:**

- **Filter Type:**

- **Single_Rate:** The data rate of the input and the output are the same.
- **Interpolation:** The data rate of the output is faster than the input by a factor specified by the Interpolation Rate value.
- **Decimation:** The data rate of the output is slower than the input by a factor specified in the Decimation Rate Value.
- **Rate Change Type:** This field is applicable to Interpolation and Decimation filter types. Used to specify an **Integer** or **Fixed_Fractional** rate change.
- **Interpolation Rate Value:** This field is applicable to all Interpolation filter types and Decimation filter types for Fractional Rate Change implementations. The value provided in this field defines the up-sampling factor, or P for Fixed Fractional Rate (P/Q) resampling filter implementations.

- **Decimation Rate Value:** This field is applicable to the all Decimation and Interpolation filter types for Fractional Rate Change implementations. The value provided in this field defines the down-sampling factor, or Q for Fixed Fractional Rate (P/Q) resampling filter implementations.
- **Zero pack factor:** Allows you to specify the number of 0's inserted between the coefficient specified by the coefficient vector. A zero packing factor of k inserts k-1 0s between the supplied coefficient values. This parameter is only active when the Filter type is set to Interpolated.
- **SSR:** SSR value.

- **Implementation tab:**

Parameters specific to the Implementation tab are as follows:

- **Coefficient Options:**

- **Coefficient Type:** Specify Signed or Unsigned.
- **Quantization:** Specifies the quantization method to be used for quantizing the coefficients. This can be set to one of the following:
 - Integer_Coefficients
 - Quantize_Only
 - Maximize_Dynamic_Range
 - Normalize_to_Centre_Coefficient
- **Coefficient Width:** Specifies the number of bits used to represent the coefficients.
- **Best Precision Fractional Bits:** When selected, the coefficient fractional width is automatically set to maximize the precision of the specified filter coefficients.
- **Coefficient Fractional Bits:** Specifies the binary point location in the coefficients datapath options

- **Coefficients Structure:**

- Specifies the coefficient structure. Depending on the coefficient structure, optimizations are made in the core to reduce the amount of hardware required to implement a particular filter configuration. The selected structure can be any of the following:
 - Inferred
 - Non-Symmetric
 - Symmetric

The vector of coefficients specified must match the structure specified unless Inferred from coefficients is selected in which case the structure is determined automatically from these coefficients.

- **Datapath Options:**

- **Output Rounding Mode:**

- Choose one of the following:

- Full_Precision
 - Truncate_LSBs
 - Non_Symmetric_Rounding_Down
 - Non_Symmetric_Rounding_Up
 - Symmetric_Rounding_to_Zero
 - Symmetric_Rounding_to_Infinity
 - Convergent_Rounding_to_Even
 - Convergent_Rounding_to_Odd

- **Output Width:** Specify the output width. Edit box activated only if the Rounding mode is set to a value other than Full_Precision.

- **Detailed Implementation tab:**

Parameters specific to the Detailed Implementation tab are as follows:

- **Filter Architecture:**

The following two filter architectures are supported.

- Systolic_Multiply_Accumulate
 - Transpose_Multiply_Accumulate

Note: When selecting the Transpose Multiply-Accumulate architecture, these limitations apply:

- Symmetry is not exploited. If the **Coefficient Vector** specified on the Filter Specification tab is detected as symmetric, the System Generator FIR Compiler 7.2 block parameters dialog box will not allow you to select Transpose Multiply Accumulate.
 - Multiple interleaved channels are not supported.

- **Optimization Options:** Specifies if the core is required to operate at maximum possible speed (“Speed” option) or minimum area (“Area” option). The “Area” option is the recommended default and will normally achieve the best speed and area for the design, however in certain configurations, the “Speed” setting might be required to improve performance at the expense of overall resource usage (this setting normally adds pipeline registers in critical paths).

- **Goal:**

- Area
- Speed
- Custom

- **List:**

A comma delimited list that specifies which optimizations are implemented by the block. The optimizations are as follows.

- **Data_Path_Fanout:** Adds additional pipeline registers on the data memory outputs to minimize fan-out. Useful when implementing large data width filters requiring multiple DSP slices per multiply-add unit.
- **Pre-Adder_Pipeline:** Pipelines the pre-adder when implemented using fabric resources. This may occur when a large coefficient width is specified.
- **Coefficient_Fanout:** Adds additional pipeline registers on the coefficient memory outputs to minimize fan-out. Useful for Parallel channels or large coefficient width filters requiring multiple DSP slices per multiply-add unit.
- **Control_Path_Fanout:** Adds additional pipeline registers to control logic when Parallel channels have been specified.
- **Control_Column_Fanout:** Adds additional pipeline registers to control logic when multiple DSP columns are required to implement the filter.
- **Control_Broadcast_Fanout:** Adds additional pipeline registers to control logic for fully parallel (one clock cycle per channel per input sample) symmetric filter implementations.
- **Control_LUT_Pipeline:** Pipelines the Look-up tables required to implement the control logic for Advanced Channel sequences.
- **No_BRAM_Read_First_Mode:** Specifies that Block RAM READ-FIRST mode should not be used.
- **Increased speed:** Multiple DSP slice columns are required for non-symmetric filter implementations.
- **Other:** Miscellaneous optimizations.

Note: All optimizations may be specified but are only implemented when relevant to the core configuration.

- **Memory Options:**

The memory type for MAC implementations can either be user-selected or chosen automatically to suit the best implementation options. Note that a choice of “Distributed” might result in a shift register implementation where appropriate to the filter structure. Forcing the RAM selection to be either Block or Distributed should be used with caution, as inappropriate use can lead to inefficient resource usage - the default Automatic mode is recommended for most applications.

- **Data Buffer Type:** Specifies the type of memory used to store data samples.
- **Coefficient Buffer Type:** Specifies the type of memory used to store the coefficients.
- **Input Buffer Type:** Specifies the type of memory to be used to implement the data input buffer, where present.
- **Output Buffer type:** Specifies the type of memory to be used to implement the data output buffer, where present.
- **Preference for other storage:** Specifies the type of memory to be used to implement general storage in the datapath.

- **DSP Slice Column Options:**

- **Multi-Column Support:** For device families with DSP slices, implementations of large high speed filters might require chaining of DSP slice elements across multiple columns. Where applicable (the feature is only enabled for multi-column devices), you can select the method of folding the filter structure across the multiple-columns, which can be Automatic (based on the selected device for the project) or Custom (you select the length of the first and subsequent columns).
- **Inter-Column Pipe Length:** Pipeline stages are required to connect between the columns, with the level of pipelining required being depending on the required system clock rate, the chosen device and other system-level parameters. The choice of this parameter is always left for you to specify.

- **Interface tab:**

- **Data Channel Options:**

- **Output TREADY:** This field enables the data_tready port. With this port enabled, the block will support back-pressure. Without the port, back-pressure is not supported, but resources are saved and performance is likely to be higher.

- **Control Options:**

- **ACLKEN:** Active-high clock enable. Available for MAC-based FIR implementations.

- ARESETn (active low):** Active-low synchronous clear input that always takes priority over ACLKEN. A minimum ARESETn active pulse of two cycles is required, since the signal is internally registered for performance. A pulse of one cycle resets the control and datapath of the core, but the response to the pulse is not in the cycle immediately following.

Other parameters used by this block are explained in the topic [Common Options in Block Parameter Dialog Boxes](#).

LogiCORE Documentation

[LogiCORE IP FIR Compiler v7.2](#)

Vector Logical

The Vector Logical block supports logical operation for vector type inputs.

Description

Super Sample Rate (SSR): This configurable GUI parameter is primarily used to control the processing of multiple data samples on every sample period. This blocks enable 1-D vector data support for the primary block operation.

The Vector Logical Block performs bitwise logical operations on fixed-point numbers. Operands are zero padded and sign extended as necessary to make binary point positions coincide. The logical operation is performed and the result is delivered at the output port.

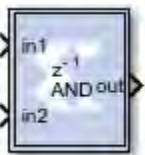

In hardware this block is implemented as synthesizable VHDL. If you build a tree of logical gates, this synthesizable implementation is best as it facilitates logic collapsing in synthesis and mapping.

Block Parameters

Double-click the icon in your Simulink® model to open the Block Parameters dialog box.

- Basic tab :** Parameters specific to the Basic tab are as follows:
 - Logical function:** Specifies one of the following bitwise logical operators: AND, NAND, OR, NOR, XOR, XNOR.

- **Number of inputs:** Specifies the number of inputs (1 - 1024).
- **Logical Reduction Operation:**

When the number of inputs is specified as 1, a unary logical reduction operation performs a bit-wise operation on the single operand to produce a single bit result. The first step of the operation applies the logical operator between the least significant bit of the operand and the next most significant bit. The second and subsequent steps apply the operator between the one-bit result of the prior step and the next bit of the operand using the same logical operator. The logical reduction operator implements the same functionality as that of the logical reduction operation in HDLs. The output of the logical reduction operation is always Boolean.

- **Output Type tab :**

Parameters specific to the Output Type tab are as follows:

- **Align binary point:** Specifies that the block must align binary points automatically. If not selected, all inputs must have the same binary point position.

Other parameters used by this block are explained in the topic [Common Options in Block Parameter Dialog Boxes](#).

Vector Mux

The Vector Multiplexer block supports the Multiplexing feature for input of vector types.

Description

Super Sample Rate (SSR): This configurable GUI parameter is primarily used to control processing of multiple data samples on every sample period. This block enables 1-D vector support for the primary block operation.

The Vector Mux block implements a multiplexer. The block has one select input (type unsigned) and a user-configurable number of data bus inputs, ranging from 2 to 1024.

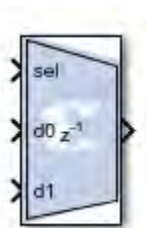

Block Parameters

Open the Block Parameters dialog box by double-clicking the icon in your Simulink® model.

- **Basic tab :**

- **Number of inputs:** Specify a number between 2 and 32.
- **Optional Ports:**

Other parameters used by this block are explained in the topic [Common Options in Block Parameter Dialog Boxes](#).

- **Output tab :**

- **Precision:**

This parameter allows you to specify the output precision for fixed-point arithmetic. Floating-point arithmetic output will always be **Full** precision.

- **Full:** The block uses sufficient precision to represent the result without error.
- **User Defined:** If you do not need full precision, this option allows you to specify a reduced number of total bits and/or fractional bits.

- **Fixed-point Output Type:**

- **Arithmetic type:**

- **Signed (2's comp):** The output is a Signed (2's complement) number.
- **Unsigned:** The output is an Unsigned number.

- **Fixed-Point Precision:**

- **Number of bits:** Specifies the bit location of the binary point of the output number where bit zero is the least significant bit.
- **Binary point:** Position of the binary point. in the fixed-point output.

- **Quantization:**

Refer to the section Overflow and Quantization in the topic [Common Options in Block Parameter Dialog Boxes](#).

- **Overflow:**

Refer to the section Overflow and Quantization in the topic [Common Options in Block Parameter Dialog Boxes](#).

Parameters used by this block are explained in the topic [Common Options in Block Parameter Dialog Boxes](#).

LogiCORE Documentation

[LogiCORE IP Floating-Point Operator v7.1](#)

Vector Real Gateway In

The Vector Real Gateway In block converts vector inputs of type Simulink® integer, single, double, and fixed-point to Xilinx® fixed-point or floating-point data type.

Hardware notes: In hardware, these blocks become top level input ports.

Description

Super Sample Rate (SSR): This configurable GUI parameter is primarily used to control processing of multiple data samples on every sample period. This block enables 1-D vector support for the primary block operation.

The Vector Real Gateway In blocks are the inputs into the Xilinx portion of your Simulink design. These blocks convert Simulink integer, double and fixed-point data types into the System Generator fixed-point type. Each block defines a top-level input port or interface in the HDL design generated by System Generator.



Conversion of Simulink Data to System Generator Data

A number of different Simulink data types are supported on the input of Vector Real Gateway In. The data types supported include int8, uint8, int16, uint16, in32, uint32, single, double, and Simulink fixed-point data type (if Simulink fixed-point data type license is available). In all cases the input data is converted to a double internal to gateway, and then converted to target data type as specified on the Vector Real Gateway In block (Fixed-point, Floating-point or Boolean). When converting to Fixed-point from the internal double representation, the Quantization, and Overflow is further handled as specified in the Block GUI. For overflow, the options are to saturate to the largest positive/smallest negative value, to wrap (for example, to discard bits to the left of the most significant representable bit), or to flag an overflow as a Simulink error during simulation. For quantization, the options are to round to the nearest representable value (or to the value furthest from zero if there are two equidistant nearest representable values), or to truncate (for example, to discard bits to the right of the least significant representable bit). It is important to realize that conversion, overflow and quantization do not take place in hardware. They take place only in the simulation model of the block.

Gateway Blocks

As listed below, the Xilinx Vector Real Gateway In block is used to provide a number of functions:

- Converting data from Simulink integer, double, and fixed-point type to the System Generator fixed-point type during simulation in Simulink.
- Defining top-level input ports or interface in the HDL design generated by System Generator.
- Defining test bench stimuli when the **Create Testbench** box is checked in the System Generator token. In this case, during HDL code generation, the inputs to the block that occur during Simulink simulation are logged as a logic vector in a data file. During HDL simulation, an entity that is inserted in the top level test bench checks this vector, and the corresponding vectors produced by Vector Real Gateway Out blocks against expected results.
- Naming the corresponding port in the top level HDL entity.

Block Parameters

Open the Block Parameters dialog box double-clicking the icon in your Simulink model.

- **Basic Tab :**

Parameters specific to the Basic Tab are as follows:

- **Output Type:**

Specifies the output data type. Can be **Boolean**, **Fixed-point**, or **Floating-point**.
- **Arithmetic Type:**

If the Output Type is specified as Fixed-point, you can select **Signed (2's comp)** or **Unsigned** as the Arithmetic Type.
- **Fixed-point Precision:**
 - **Number of bits:** Specifies the bit location of the binary point, where bit zero is the least significant bit.
 - **Binary point:** Specifies the bit location of the binary point, where bit zero is the least significant bit.
- **Floating-point Precision:**
 - **Single:** Specifies single precision (32 bits).
 - **Double:** Specifies double precision (64 bits).
 - **Custom:** Activates the field below so you can specify the Exponent width and the Fraction width.
 - **Exponent width:** Specify the exponent width.

- **Fraction width:** Specify the fraction width.
- **Quantization:**

Quantization errors occur when the number of fractional bits is insufficient to represent the fractional portion of a value. The options are to **Truncate** (for example, to discard bits to the right of the least significant representable bit), or to **Round(unbiased: +/- inf)** or **Round(unbiased: even values)**.

Round(unbiased: +/- inf) also known as "Symmetric Round (towards +/- inf)" or "Symmetric Round (away from zero)". This is similar to the MATLAB `round()` function. This method rounds the value to the nearest desired bit away from zero and when there is a value at the midpoint between two possible rounded values, the one with the larger magnitude is selected. For example, to round 01.0110 to a `Fix_4_2`, this yields 01.10, since 01.0110 is exactly between 01.01 and 01.10 and the latter is further from zero.

- **Overflow:**

Overflow errors occur when a value lies outside the representable range. For overflow the options are to **Saturate** to the largest positive/smallest negative value, to **Wrap** (for example, to discard bits to the left of the most significant representable bit), or to **Flag as error** (an overflow as a Simulink error) during simulation. **Flag as error** is a simulation only feature. The hardware generated is the same as when **Wrap** is selected.

- **Implementation Tab:**

Parameters specific to the Implementation Tab are as follows:

- **Interface Options:**

- **Interface:**

- **None:** Implies that during HDL Netlist generation, this Vector Real Gateway In is translated as an Input Port at the top level.
- **AXI4-Lite:** Implies that during HDL Netlist generation, an AXI4-Lite interface will be created, and this Vector Real Gateway In is mapped to one of the registers within the AXI4-Lite interface.

- **Auto assign address offset:**

If the Vector Real Gateway In is configured to be an AXI4-Lite interface, this option allows an address offset to be automatically assigned to the register within the AXI4-Lite interface that the Vector Real Gateway In is mapped to.

- **Address offset:**

If Auto assign address offset is not checked, then this entry box allows you to explicitly specify an address offset to use. Must be a multiple of 4.

- **Interface Name:**

If the Vector Real Gateway In is configured to be an AX4-Lite interface, assigns a unique name to this interface. This name can be used to differentiate between multiple AXI4-Lite interfaces in the design. When using the IP catalog flow, you can expect to see an interface in the IP that System Generator creates with the name

```
<design_name>_<interface_name>_s_axi.
```



IMPORTANT! *The **Interface Name** must be composed of alphanumeric characters (lowercase alphabetic) or an underscore (_) only, and must begin with a lowercase alphabetic character. `axi4_lite1` is acceptable, `1AXI4-Lite` is not.*

- **Description:**

Additional designer comments about this Vector Real Gateway In that is captured in the interface documentation.

- **Default value:**

- **Constraints:**

- **IOB Timing Constraint:**

In hardware, a Vector Real Gateway In is realized as a set of input/output buffers (IOBs). There are three ways to constrain the timing on IOBs. They are None, Data Rate, and Data Rate, Set 'FAST' Attribute.

- If **None** is selected, no timing constraints for the IOBs are put in the user constraint file produced by System Generator. This means the paths from the IOBs to synchronous elements are not constrained.
- If **Data Rate** is selected, the IOBs are constrained at the data rate at which the IOBs operate. The rate is determined by System Clock Period provided on the System Generator token and the sample rate of the Gateway relative to the other sample periods in the design.
- If **Data Rate, Set 'FAST' Attribute** is selected, the constraints described above are produced. In addition, a FAST slew rate attribute is generated for each IOB. This reduces delay but increases noise and power consumption.
- **Specify IOB location constraints:** Checking this option allows IOB location constraints and I/O standards to be specified.
- **IOB pad locations, e.g. {'MSB', ..., 'LSB'}:** IOB pin locations can be specified as a cell array of strings in this edit box. The locations are package-specific. IO Standards, e.g. {'MSB', ..., 'LSB'}
- **IO Standards, e.g. {'MSB', ..., 'LSB'}:** I/O standards can be specified as a cell array of strings in this edit box. The locations are package-specific.

Vector Real Gateway Out

The Vector Real Gateway Out block converts Xilinx® fixed-point or floating-point type vector inputs into vector outputs of type Simulink® integer, single, double, or fixed-point.

Hardware notes: In hardware these blocks become top level output ports or are discarded depending on how they are configured.

Description

Super Sample Rate (SSR): This configurable GUI parameter is primarily used to control processing of multiple data samples on every sample period. This blocks enable 1-D vector support for the primary block operation.

Vector Real Gateway Out blocks are the outputs from the Xilinx portion of your Simulink design. This block converts the System Generator fixed-point or floating-point data type into a Simulink integer, single, double, or fixed-point data type.



According to its configuration, the Vector Real Gateway Out block can either define an output port for the top level of the HDL design generated by System Generator, or be used simply as a test point that is trimmed from the hardware representation

Gateway Blocks

As listed below, the Vector Real Gateway Out block is used to provide the following functions:

- Convert data from a System Generator fixed-point or floating-point data type into a Simulink integer, single, double, or fixed-point data type.
- Define I/O ports for the top level of the HDL design generated by System Generator. A Vector Real Gateway Out block defines a top-level output port.
- Define test bench result vectors when the System Generator **Create Testbench** box is checked. In this case, during HDL code generation, the outputs from the block that occur during Simulink simulation are logged as logic vectors in a data file. For each top level port, an HDL component is inserted in the top-level test bench that checks this vector against expected results during HDL simulation.
- Name the corresponding output port on the top-level HDL entity.

Block Parameters

- **Basic Tab :**

Parameters specific to the Basic Tab are as follows.

- Propagate data type to output:** This option is useful when you instantiate a System Generator design as a sub-system into a Simulink design. Instead of using a Simulink double as the output data type by default, the System Generator data type is propagated to an appropriate Simulink data type according to the following table:

Table 23: System Generator Data Type Propagation

System Generator Data Type	Simulink Data Type
XFloat_8_24	single
XFloat_11_53	double
Custom floating-point precision data type exponent width and fraction width less than those for single precision	single
Custom floating-point precision data type with exponent width or fraction width greater than that for single precision	double
XFix_<width>_<binpt>	sfix<width>_EN<binpt>
UFix_<width>_<binpt>	ufix<width>_EN<binpt>
XFix_<width>_0 where width is 8, 16 or 32	int<width> where width is 8, 16 or 32
UFix_<width>_0 where width is 8, 16 or 32	uint<width> where width is 8, 16 or 32
XFix_<width>_0 where width is other than 8, 16 or 32	sfix<width>
UFix_<width>_0 where width is other than 8, 16 or 32	ufix<width>

- Translate into Output Port:** Having this box unchecked prevents the gateway from becoming an actual output port when translated into hardware. This checkbox is on by default, enabling the output port. When this option is not selected, the Vector Real Gateway Out block is used only during debugging, where its purpose is to communicate with Simulink Sink blocks for probing portions of the design. In this case, the Vector Real Gateway Out block turns gray in color, indicating that the gateway will not be translated into an output port.
- Implementation Tab :** Parameters specific to the Implementation Tab are as follows.
 - Interface Options:**
 - None:** During HDL Netlist generation, this Vector Real Gateway Out will be translated as an Output Port at the top level.
 - AXI4-Lite:** During HDL Netlist Generation, an AXI4-Lite interface will be created, and the Vector Real Gateway Out will be mapped to one of the registers within the AXI4-Lite interface.
 - Interrupt:** During an IP catalog Generation, this Vector Real Gateway Out is tagged as an Interrupt output port when the System Generator design is packaged into an IP module that can be included in the Vivado® IP catalog.
 - Auto assign address offset:**

If a Vector Real Gateway Out is configured to be an AXI4-Lite interface, this option allows an address offset to be automatically assigned to the register within the AXI4-Lite interface that the Vector Real Gateway Out is mapped to.

- **Address offset:**

If Auto assign address offset is not checked, then this entry box allows you to explicitly specify a address offset to use. Must be a multiple of 4.

- **Interface Name:**

If the Vector Real Gateway Out is configured to be an AX4-Lite interface, assigns a unique name to this interface. This name can be used to differentiate between multiple AXI4-Lite interfaces in the design. When using the IP catalog flow, you can expect to see an interface in the IP that System Generator creates with the name

`<design_name>_<interface_name>_ s_axi.`



IMPORTANT! The **Interface Name** must be composed of alphanumeric characters (lowercase alphabetic) or an underscore (`_`) only, and must begin with a lowercase alphabetic character. `axi4_lite1` is acceptable, `1AXI4-Lite` is not.

- **Description:**

Additional designer comments about this Vector Real Gateway Out that is captured in the interface documentation.

- **Constraints:**

- **IOB Timing Constraint:**

In hardware, a Vector Real Gateway Out is realized as a set of input/output buffers (IOBs). There are three ways to constrain the timing on IOBs. They are None, Data Rate, and Data Rate, Set 'FAST' Attribute.

- **None:** No timing constraints for the IOBs are put in the user constraint file produced by System Generator. This means the paths from the IOBs to synchronous elements are not constrained.

- **Data Rate:**

The IOBs are constrained at the data rate that the IOBs operate. The rate is determined by System Clock Period provided on the System Generator token and the sample rate of the Gateway relative to the other sample periods in the design. For example, the following OFFSET = OUT constraints are generated for a Vector Real Gateway Out named 'Dout' that is running at the system period of 10 ns:

```
# Offset out constraints
NET "Dout(0)" OFFSET = OUT : 10.0 : AFTER "clk";
NET "Dout(1)" OFFSET = OUT : 10.0 : AFTER "clk";
NET "Dout(2)" OFFSET = OUT : 10.0 : AFTER "clk";
```

- **Specify IOB Location Constraints:** Checking this option allows IOB location constraints to be specified.
- **IOB Pad Locations, e.g. {'MSB', ..., 'LSB'}:** IOB pin locations can be specified as a cell array of strings in this edit box. The locations are package-specific.
- **Data Rate, Set 'FAST' Attribute:**

The OFFSET = OUT constraints described above are produced. In addition, a FAST slew rate attribute is generated for each IOB. This reduces delay but increases noise and power consumption. For the previous example, the following additional attributes are added to the constraints file

```
NET "Dout(0)" FAST;
NET "Dout(1)" FAST;
NET "Dout(2)" FAST;
```

Other parameters used by this block are explained in the topic [Common Options in Block Parameter Dialog Boxes](#).

Vector Real Mult

The Vector Real Multiplier block supports the multiplication feature for vector type inputs.

Hardware notes: To check for the optimum internal pipeline stages of the dedicated multiplier select 'Test for optimum pipelining'.

Optimization Goal: For implementation into device fabric (LUTs), the Speed or Area optimization takes effect only if it is supported by IP for the particular device family. Otherwise, the results will be identical regardless of the selection.

Description

Super Sample Rate (SSR): This configurable GUI parameter is primarily used to control processing of multiple data samples on every sample period. This block enables 1-D vector support for the primary block operation.

The Vector Real Mult block implements a multiplier. It computes the product of the data on its two input ports, producing the result on its output port.

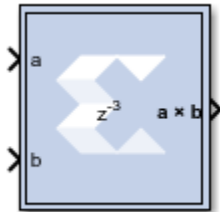

Block Parameters

Open the Block Parameters dialog box by double-clicking the icon in your Simulink® model.

- **Basic tab:**

Parameters specific to the Basic tab are as follows.

- **Precision:**

This parameter allows you to specify the output precision for fixed-point arithmetic. Floating-point output always has **Full** precision.

- **Full:** The block uses sufficient precision to represent the result without error.
- **User Defined:** If you do not need full precision, this option allows you to specify a reduced number of total bits and/or fractional bits.
- **User-Defined Precision:**
 - **Fixed-point Precision:**
 - **Signed (2's comp):** The output is a Signed (2's complement) number.
 - **Unsigned:** The output is an Unsigned number.
 - **Number of bits:** Specifies the bit location of the binary point of the output number, where bit zero is the least significant bit.
 - **Binary point:** Position of the binary point in the fixed-point output.
 - **Quantization:** Refer to the Overflow and Quantization section in the [Common Options in Block Parameter Dialog Boxes](#) topic.

- **Overflow:**

Refer to the Overflow and Quantization section in the [Common Options in Block Parameter Dialog Boxes](#) topic.

- **Optional Port:** Provide enable port.

- **Latency:** This defines the number of sample periods by which the block's output is delayed.

- **Saturation and Rounding of User Data Types in a Multiplier:** When saturation or rounding is selected on the user data type of a multiplier, latency is also distributed so as to pipeline the saturation/rounding logic first, and then additional registers are added to the core. For example, if a latency of three is selected, and rounding/saturation is selected, then the first register is placed after the rounding or saturation logic, and two registers are placed to pipeline the core. Registers are added to the core until optimum pipelining is reached and then further registers are placed after the rounding/saturation logic. However, if the data type you select does not require additional saturation/rounding logic, then all the registers are used to pipeline the core.

- **Implementation tab :**

Parameters specific to the Implementation tab are as follows:

- **Use behavioral HDL (otherwise use core):**

The block is implemented using behavioral HDL. This gives the downstream logic synthesis tool maximum freedom to optimize for performance or area.

Note: For Floating-point operations, the block always uses the Floating-point Operator core.

- **Core Parameters:**

- **Optimize for Speed|Area:** Directs the block to be optimized for either Speed or Area.

- **Use embedded multipliers:** This field specifies that if possible, use the XtremeDSP slice (DSP48 type embedded multiplier) in the target device.

- **Test for optimum pipelining:** Checks if the Latency provided is at least equal to the optimum pipeline length. Latency values that pass this test imply that the core produced is optimized for speed.

Other parameters used by this block are explained in the topic [Common Options in Block Parameter Dialog Boxes](#).

LogiCORE™ Documentation

[LogiCORE IP Multiplier v12.0](#)

[LogiCORE IP Floating-Point Operator v7.1](#)

Vector Register

The Vector Register block supports vector type inputs.

Description

Super Sample Rate (SSR): This configurable GUI parameter is primarily used to control processing of multiple data samples on every sample period. This block enables 1-D vector support for the primary block operation.

The Vector Register block models a D flip-flop-based register, having latency of one sample period.



Block Interface

The block has one input port for the data and an optional input reset port. The initial output value is specified by you in the block parameters dialog box (below). Data presented at the input will appear at the output after one sample period. Upon reset, the register assumes the initial value specified in the parameters dialog box.

The Vector Register block differs from the Xilinx Delay block by providing an optional reset port and a user specifiable initial value.

Block Parameters

Open the block parameters dialog box by double-clicking the icon in your Simulink® model.

- **Basic Tab:**

Parameters specific to the Basic tab are as follows.

- **Initial value:** Specifies the initial value in the register.
- **Optional Ports:**
 - Provide synchronous reset port.
 - Provide enable port.

Other parameters used by this block are explained in the topic [Common Options in Block Parameter Dialog Boxes](#).

Xilinx LogiCORE

The Vector Register block is implemented as a synthesizable VHDL module. It does not use a Xilinx LogiCORE™.

Vector Reinterpret

The Vector Reinterpret block changes the vector input signal type without altering the binary representation. You can change the signal between signed and unsigned, and relocate the binary point.

Hardware notes: In hardware this block costs nothing.

Example: The input is 6 bits wide, signed with 2 fractional bits, and the output is forced to unsigned with 0 fractional bits. Then an input of -2.0 (1110.00 in binary 2's complement) becomes an output of 56 (111000 in binary).

Description

Super Sample Rate (SSR): This configurable GUI parameter is primarily used to control processing of multiple data samples on every sample period. This block enables 1-D vector data support for the primary block operation.

The Vector Reinterpret block forces its output to a new type without any regard for retaining the numerical value represented by the input.



The binary representation is passed through unchanged, so in hardware this block consumes no resources. The number of bits in the output will always be the same as the number of bits in the input.

The block allows for unsigned data to be reinterpreted as signed data, or, conversely, for signed data to be reinterpreted as unsigned. It also allows for the reinterpolation of the data's scaling, through the repositioning of the binary point within the data. The Xilinx Scale block provides an analogous capability.

An example of this block's use is as follows: if the input type is 6 bits wide and signed, with 2 fractional bits, and the output type is forced to be unsigned with 0 fractional bits, then an input of -2.0 (1110.00 in binary, two's complement) would be translated into an output of 56 (111000 in binary).

This block can be particularly useful in applications that combine it with the Xilinx Slice block or the Xilinx Concat block. To illustrate the block's use, consider the following scenario:

Given two signals, one carrying signed data, and the other carrying two unsigned bits (a `UFix_2_0`), we want to design a system that concatenates the two bits from the second signal onto the tail (least significant bits) of the signed signal.

We can do so using two Vector Reinterpret blocks and one Vector Concat block. The first Vector Reinterpret block is used to force the signed input signal to be treated as an unsigned value with its binary point at zero. The result is then fed through the Vector Concat block along with the other signal's `UFix_2_0`. The Concat operation is then followed by a second Vector Reinterpret that forces the output of the Vector Concat block back into a signed interpretation with the binary point appropriately repositioned.

Though three blocks are required in this construction, the hardware implementation is realized as simply a bus concatenation, which has no cost in hardware.

Block Parameters

Parameters specific to the block are as follows.

- **Force Arithmetic Type:** When checked, the Output Arithmetic Type parameter can be set and the output type is forced to the arithmetic type chosen according to the setting of the Output Arithmetic Type parameter. When unchecked, the arithmetic type of the output is unchanged from the arithmetic type of the input.
- **Output Arithmetic Type:** The arithmetic type (unsigned or signed, 2's complement, Floating-point) to which the output is to be forced.
- **Force Binary Point:** When checked, the Output Binary Point parameter can be set and the binary point position of the output is forced to the position supplied in the Output Binary Point parameter. When unchecked, the arithmetic type of the output is unchanged from the arithmetic type of the input.
- **Output Binary Point:** The position to which the output's binary point is to be forced. The supplied value must be an integer between zero and the number of bits in the input (inclusive).

LogiCORE Documentation

[LogiCORE IP Floating-Point Operator v7.1](#)

Vector Relational

The Vector Relational block implements comparator for vector inputs.

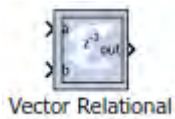

Description

Super Sample Rate (SSR): This configurable GUI parameter is primarily used to control processing of multiple data samples on every sample period. This block enables 1-D vector data support for the primary block operation.

Block Parameters

The block parameters dialog box can be invoked by double-clicking the icon in your Simulink® model.

The only parameter specific to the Vector Relational block is:

- **Comparison:** specifies the comparison operation computed by the block.

Other parameters used by this block are explained in the topic [Common Options in Block Parameter Dialog Boxes](#).

LogiCORE Documentation

[LogiCORE IP Floating-Point Operator v7.1](#)

Vector Slice

The Vector Slice block supports vector type inputs.

Extracts a given range of bits from each sample of input vector and presents it at the output. The output type is ordinarily unsigned with binary point at zero, but can be Boolean when the slice is one bit wide.

Hardware notes: In hardware this block costs nothing.

Description

Super Sample Rate (SSR): This configurable GUI parameter is primarily used to control processing of multiple data samples on every sample period. This block enables 1-D vector support for the primary block operation.

The Vector Slice block allows you to slice off a sequence of bits from your input data and create a new data value. This value is presented as the output from the block. The output data type is unsigned with its binary point at zero.



The block provides several mechanisms by which the sequence of bits can be specified. If the input type is known at the time of parameterization, the various mechanisms do not offer any gain in functionality. If, however, a Vector Slice block is used in a design where the input data width, or binary point position are subject to change, the variety of mechanisms becomes useful. The block can be configured, for example, always to extract only the top bit of the input, or only the integral bits, or only the first three fractional bits. The following diagram illustrates how to extract all but the top 16 and bottom 8 bits of the input.

Figure 88: Extracting Top 16 and Bottom 8 Bits

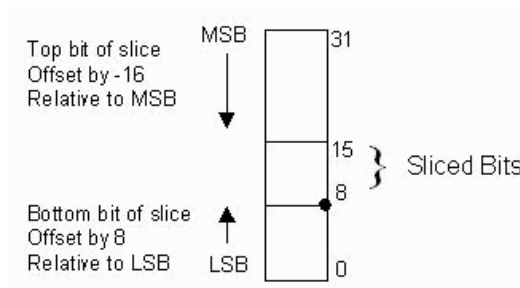

Block Parameters

Open the Block Parameters dialog box by double-clicking the icon in your Simulink® model.

Parameters specific to the block are as follows.

- **Width of slice (Number of bits):** Specifies the number of bits to extract.
- **Boolean output:** Tells whether single bit slices should be type Boolean.
- **Specify range as:** (Two bit locations | Upper bit location + width | Lower bit location + width). Allows you to specify either the bit locations of both end-points of the slice, or one end-point along with number of bits to be taken in the slice.
- **Offset of top bit:** Specifies the offset for the ending bit position from the LSB, MSBm, or binary point.
- **Offset of bottom bit:** Specifies the offset for the ending bit position from the LSB, MSBm, or binary point.

- **Relative to:** Specifies the bit slice position relative to the MSB, LSB, or binary point of the top or the bottom of the slice.

Other parameters used by this block are explained in the topic [Common Options in Block Parameter Dialog Boxes](#).

Vector Up Sample

The Vector Up Sample block up samples input vector data. Inserted values can be zeros or copies of the most recent input sample.

Hardware notes: No hardware is needed if inserted values are copies of the input sample. Otherwise, a mux, and single bit flip-flop are used.

Description

Super Sample Rate (SSR): This configurable GUI parameter is primarily used to control processing of multiple data samples on every sample period. This blocks enable 1-D vector support for the primary block operation.

The Vector Up Sample block increases the sample rate at the point where the block is placed in your design. The output sample period is l/n , where l is the input sample period, and n is the sampling rate.



The input signal is up sampled so that within an input sample frame, an input sample is either presented at the output n times if samples are copied, or presented once with $(n-1)$ zeroes interspersed if zero padding is used.

In hardware, the Vector Up Sample block has two possible implementations. If the Copy Samples option is selected on the block parameters dialog box, the Din port is connected directly to Dout and no hardware is expended. Alternatively, if zero padding is selected, a mux is used to switch between the input sample, and inserted zeros. The corresponding circuit for the zero padding Vector Up Sample block is shown below.

Figure 89: Zero Padding Up Sample Circuit

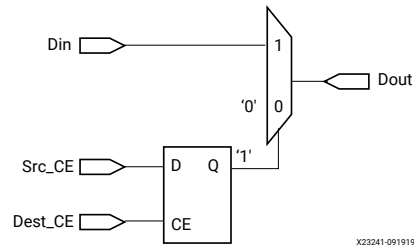

Block Interface

The Vector Up Sample block receives two clock enable signals, Src_CE, and Dest_CE. Src_CE is the clock enable signal corresponding to the input data stream rate. Dest_CE is the faster clock enable, corresponding to the output data stream rate. Notice that the circuit uses a single flip-flop in addition to the mux. The flip-flop is used to adjust the timing of Src_CE, so that the mux switches to the data input sample at the start of the input sample period, and switches to the constant zero after the first input sample. It is important to notice that the circuit has a combinational path from Din to Dout. As a result, a Vector Up Sample block configured to zero pad should be followed by a register whenever possible.

Figure 90: Up Sample Output

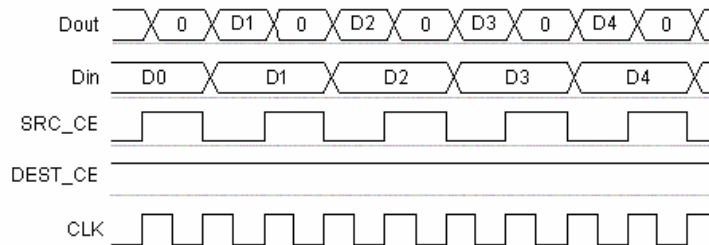

Block Parameters

Open the Block Parameters dialog box by double-clicking the icon in your Simulink® model.

- **Basic tab:** Parameters specific to the Basic tab are as follows.
 - **Sampling rate (number of output samples per input sample):** Must be an integer with a value of 2 or greater. This is the ratio of the output sample period to the input, and is essentially a sample rate multiplier. For example, a ratio of 2 indicates a doubling of the input sample rate. If a non-integer ratio is desired, the Vector Up Sample block can be used in combination with the Vector Down Sample block.
 - **Copy samples (otherwise zeros are inserted):** Allows you to choose what to do with the additional samples produced by the increased clock rate. By selecting Copy Samples, the same sample is duplicated (copied) during the extra sample times. If this checkbox is not selected, the additional samples are zero.

- **Provide enable port:** When checked, this option adds an en (enable) input port, if the Latency is specified as a positive integer greater than zero.
- **Latency:** This defines the number of sample periods by which the block's output is delayed. One sample period can correspond to multiple clock cycles in the corresponding FPGA implementation (for example, when the hardware is over-clocked with respect to the Simulink model). The user defined sample latency is handled in the Vector Up Sample block by placing shift registers that are clock enabled at the input sample rate, on the input of the block. The behavior of a Vector Up Sample block with non-zero latency is similar to putting a delay block, with equivalent latency, at the input of an Vector Up Sample block with zero latency.

Parameters used by this block are explained in the topic [Common Options in Block Parameter Dialog Boxes](#).

Vector2Scalar

The Vector2Scalar block converts vector type input to scalar type output.

Description

The Vector2Scalar block does the bit level concatenation of all the elements of the input vector to produce a scalar output.

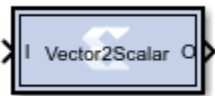

For example, if the input vector is [0 1 2 7] of type `Ufix_3_0`, and the SSR parameter is 4, it produces Scalar output 3720 of type `Ufix_12_0`, whose binary value is 111 010 001 000. This value represents input vector when we split it into four groups each of 3 bits.

Data Type Support

- The inputs must be Boolean or unsigned fixed-point signal.
- All inputs must have binary set to 0.

Parameters

Super Sample Rate (SSR): This configurable GUI parameter is primarily used to control processing of multiple data samples on every sample period. This block enables 1-D vector support for the primary block operation.

Xilinx Reference Blockset

Organization of Reference Blockset Libraries

The following reference libraries are provided:

Communication

Communication Reference Designs
BPSK AWGN Channel
Convolutional Encoder
White Gaussian Noise Generator

Control Logic

Control Logic Reference Designs
Mealy State Machine
Moore State Machine
Registered Mealy State Machine
Registered Moore State Machine

DSP

DSP Reference Designs
2 Channel Decimate by 2 MAC FIR Filter
2n+1-tap Linear Phase MAC FIR Filter
2n-tap Linear Phase MAC FIR Filter
2n-tap MAC FIR Filter
4-channel 8-tap Transpose FIR Filter
4n-tap MAC FIR Filter
CIC Filter
Dual Port Memory Interpolation MAC FIR Filter
Interpolation Filter
m-channel n-tap Transpose FIR Filter

DSP Reference Designs
n-tap Dual Port Memory MAC FIR Filter
n-tap MAC FIR Filter

Imaging

Imaging Reference Designs
5x5Filter
Virtex Line Buffer
Virtex2 5 Line Buffer
Virtex2 Line Buffer

Math

Math Reference Designs
CORDIC ATAN
CORDIC DIVIDER
CORDIC LOG
CORDIC SIN COS
CORDIC SQRT

2 Channel Decimate by 2 MAC FIR Filter

The Xilinx n-tap 2 Channel Decimate by 2 MAC FIR Filter reference block implements a multiply-accumulate-based FIR filter. One dedicated multiplier and one Dual Port Block RAM are used in the n-tap filter. The same MAC engine is used to process both channels that are time division multiplexed (TDM) together. Completely different coefficient sets can be specified for each channel as long as they have the same number of coefficients. The filter also provides a fixed decimation by 2 using a polyphase filter technique. The filter configuration helps illustrate techniques for storing multiple coefficient sets and data samples in filter design. The Virtex FPGA family (and Virtex family derivatives) provide dedicated circuitry for building fast, compact adders, multipliers, and flexible memory architectures. The filter design takes advantage of these silicon features by implementing a design that is compact and resource efficient.

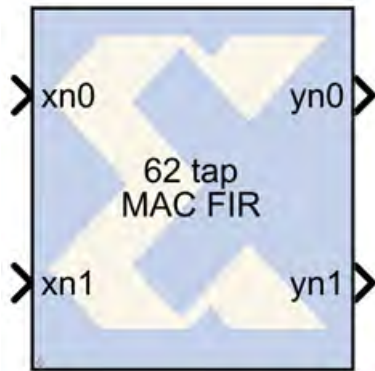

Implementation details are provided in the filter design Subsystems. To read the annotations, place the block in a model, then right-click on the block and select **Explore** from the popup menu. Double click on one of the sub-blocks to open the sub-block model and read the annotations.

Block Parameters

The block parameters dialog box can be invoked by double-clicking the icon in your Simulink model.

Parameters specific to this reference block are as follows:

- **Data Input Bit Width:** Width of input sample.
- **Data Input Binary Point:** Binary point location of input.
- **Coefficient Vector (Ch.1):** Specify coefficients for Channel 1 of the filter. Number of taps is inferred from size of coefficient vector.
- **Coefficient Vector (Ch.2):** Specify coefficients for Channel 2 of the filter. Number of taps is inferred from size of coefficient vector.

Note: Coefficient Vectors must be the same size. Pad coefficients if necessary to make them the same size.

- **Number of Bits per Coefficient:** Bit width of each coefficient.
- **Binary Point per Coefficient:** Binary point location for each coefficient.

Note: Coefficient Vectors must be the same size. Pad coefficients if necessary to make them the same size.

- **Sample Period:** Sample period of input

Reference

J. Hwang and J. Ballagh. *Building Custom FIR Filters Using System Generator*. 12th International Field-Programmable Logic and Applications Conference (FPL). Montpellier, France, September 2002. Lecture Notes in Computer Science 2438

2n+1-tap Linear Phase MAC FIR Filter

The Xilinx 2n+1-tap Linear Phase MAC FIR Filter reference block implements a multiply-accumulate-based FIR filter. The 2n+1-tap Linear Phase MAC FIR filter exploits coefficient symmetry for an odd number of coefficients to increase filter throughput. These filter designs exploit silicon features found in Virtex family FPGAs such as dedicated circuitry for building fast, compact adders, multipliers, and flexible memory architectures.



Implementation details are provided in the filter design Subsystems. To read the annotations, place the block in a model, then right-click on the block and select **Explore** from the popup menu. Double click on one of the sub-blocks to open the sub-block model and read the annotations.

Block Parameters

The block parameters dialog box can be invoked by double-clicking the icon in your Simulink model.

Parameters specific to this reference block are as follows:

- **Coefficients:** Specify coefficients for the filter. Number of taps is inferred from size of coefficient vector.
- **Number of Bits per Coefficient:** Bit width of each coefficient.
- **Binary Point for Coefficient:** Binary point location for each coefficient.
- **Number of Bits per Input Sample:** Width of input sample.
- **Binary Point for Input Samples:** Binary point location of input.
- **Input Sample Period:** Sample period of input.

Reference

J. Hwang and J. Ballagh. *Building Custom FIR Filters Using System Generator*. 12th International Field-Programmable Logic and Applications Conference (FPL). Montpellier, France, September 2002. Lecture Notes in Computer Science 2438.

2n-tap Linear Phase MAC FIR Filter

The Xilinx 2n-tap linear phase MAC FIR filter reference block implements a multiply-accumulate-based FIR filter. The block exploits coefficient symmetry for an even number of coefficients to increase filter throughput. These filter designs exploit silicon features found in Virtex family FPGAs such as dedicated circuitry for building fast, compact adders, multipliers, and flexible memory architectures.



Implementation details are provided in the filter design Subsystems. To read the annotations, place the block in a model, then right-click on the block and select **Explore** from the popup menu. Double click on one of the sub-blocks to open the sub-block model and read the annotations.

Block Parameters

The block parameters dialog box can be invoked by double-clicking the icon in your Simulink model.

Parameters specific to this reference block are as follows:

- **Coefficients:** Specify coefficients for the filter. Number of taps is inferred from size of coefficient vector.
- **Number of Bits per Coefficient:** Bit width of each coefficient.
- **Binary Point for Coefficient:** Binary point location for each coefficient.
- **Number of Bits per Input Sample:** Width of input sample.
- **Binary Point for Input Samples:** Binary point location of input.
- **Input Sample Period:** Sample period of input.

Reference

J. Hwang and J. Ballagh. *Building Custom FIR Filters Using System Generator*. 12th International Field-Programmable Logic and Applications Conference (FPL). Montpellier, France, September 2002. Lecture Notes in Computer Science 2438.

2n-tap MAC FIR Filter

The Xilinx 2n-tap MAC FIR Filter reference block implements a multiply-accumulate-based FIR filter. The three filter configurations help illustrate the tradeoffs between filter throughput and device resource consumption. The Virtex FPGA family (and Virtex family derivatives) provide dedicated circuitry for building fast, compact adders, multipliers, and flexible memory architectures. Each filter design takes advantage of these silicon features by implementing a design that is compact and resource efficient.



Implementation details are provided in the filter design Subsystems. To read the annotations, place the block in a model, then right-click on the block and select **Explore** from the popup menu. Double click on one of the sub-blocks to open the sub-block model and read the annotations.

Block Parameters

The block parameters dialog box can be invoked by double-clicking the icon in your Simulink model.

Parameters specific to this reference block are as follows:

- **Coefficients:** Specify coefficients for the filter. Number of taps is inferred from size of coefficient vector.
- **Number of Bits per Coefficient:** Bit width of each coefficient.
- **Binary Point for Coefficient:** Binary point location for each coefficient.
- **Number of Bits per Input Sample:** Width of input sample.
- **Binary Point for Input Samples:** Binary point location of input.
- **Input Sample Period:** Sample period of input.

Reference

J. Hwang and J. Ballagh. *Building Custom FIR Filters Using System Generator*. 12th International Field-Programmable Logic and Applications Conference (FPL). Montpellier, France, September 2002. Lecture Notes in Computer Science 2438.

4-channel 8-tap Transpose FIR Filter

The Xilinx 4-channel 8-tap Transpose FIR Filter reference block implements a 4-channel 8-tap transpose FIR filter. The transpose structure is well suited for data path processing in Xilinx FPGAs, and is easily extended to produce larger filters (space accommodating). The filter takes advantage of silicon features found in the Virtex family FPGAs such as dedicated circuitry for building fast, compact adders, multipliers, and flexible memory architectures.

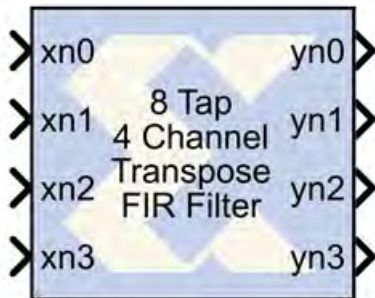

Implementation details are provided in the filter design Subsystems. To read the annotations, place the block in a model, then right-click on the block and select **Explore** from the popup menu. Double click on one of the sub-blocks to open the sub-block model and read the annotations.

Block Parameters

The block parameters dialog box can be invoked by double-clicking the icon in your Simulink model.

Parameters specific to this reference block are as follows:

- **Coefficients:** Specify coefficients for the filter. Number of taps is inferred from size of coefficient vector.
- **Number of Bits per Coefficient:** Bit width of each coefficient.
- **Binary Point for Coefficient:** Binary point location for each coefficient.
- **Number of Bits per Input Sample:** Width of input sample.
- **Binary Point for Input Samples:** Binary point location of input.
- **Input Sample Period:** Sample period of input.

4n-tap MAC FIR Filter

The Xilinx 4n-tap MAC FIR Filter reference block implements a multiply-accumulate-based FIR filter. The three filter configurations help illustrate the tradeoffs between filter throughput and device resource consumption. The Virtex FPGA family (and Virtex family derivatives) provide dedicated circuitry for building fast, compact adders, multipliers, and flexible memory architectures. Each filter design takes advantage of these silicon features by implementing a design that is compact and resource efficient.

Implementation details are provided in the filter design Subsystems. To read the annotations, place the block in a model, then right-click on the block and select **Explore** from the popup menu. Double click on one of the sub-blocks to open the sub-block model and read the annotations.

Block Parameters



The block parameters dialog box can be invoked by double-clicking the icon in your Simulink model.

Parameters specific to this reference block are as follows:

- **Coefficients:** Specify coefficients for the filter. Number of taps is inferred from size of coefficient vector.
- **Number of Bits per Coefficient:** Bit width of each coefficient.
- **Binary Point for Coefficient:** Binary point location for each coefficient.
- **Number of Bits per Input Sample:** Width of input sample.
- **Binary Point for Input Samples:** Binary point location of input.
- **Input Sample Period:** Sample period of input.

Reference

J. Hwang and J. Ballagh. *Building Custom FIR Filters Using System Generator*. 12th International Field-Programmable Logic and Applications Conference (FPL). Montpellier, France, September 2002. Lecture Notes in Computer Science 2438.

5x5Filter

The Xilinx 5x5 Filter reference block is implemented using 5 n-tap MAC FIR Filters. The filters can be found in the Imaging library of the Xilinx Reference Blockset.

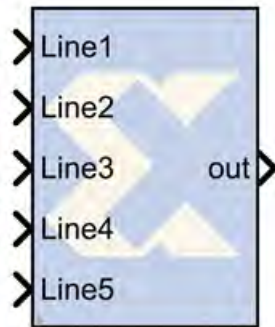

Nine different 2-D filters have been provided to filter grayscale images. The filter can be selected by changing the mask parameter on the 5x5 Filter block. The 2-D filter coefficients are stored in a block RAM, and the model makes no specific optimizations for these coefficients. You can substitute your own coefficients and scale factor by modifying the mask of the 5x5 filter block, under the Initialization tab.

The coefficients used are shown below for the 9 filters. The output of the filter is multiplied by the scale factor named <filter name>Div.

```

edge = [ 0 0 0 0 0; ...
0 -1 -1 -1 0; ...
0 -1 -1 -1 0; ...
0 0 0 0 0];
edgeDiv = 1;

sobelX = [ 0 0 0 0 0; ...
0 -1 0 1 0; ...
0 -2 0 2 0; ...
0 -1 0 1 0; ...
0 0 0 0 0];
sobelXDiv = 1;

sobelY = [ 0 0 0 0 0; ...
0 1 2 1 0; ...
0 0 0 0 0; ...
0 -1 -2 -1 0; ...
0 0 0 0 0];
sobelYDiv = 1;

sobelXY = [ 0 0 0 0 0; ...
0 0 -1 -1 0; ...
0 1 0 -1 0; ...
0 1 1 0 0; ...
0 0 0 0 0];
    
```

```

sobelXYDiv = 1;

blur = [ 1  1  1  1 1; ...
1  0  0  0 1; ...
1  0  0  0 1; ...
1  0  0  0 1; ...
1  1  1  1 1];
blurDiv = 1/16;

smooth = [ 1  1  1  1 1; ...
1  5  5  5 1; ...
1  5 44  5 1; ...
1  5  5  5 1; ...
1  1  1  1 1];
smoothDiv = 1/100;

sharpen = [ 0  0  0  0 0; ...
0 -2 -2 -2 0; ...
0 -2 32 -2 0; ...
0 -2 -2 -2 0; ...
0  0  0  0 0];
sharpenDiv = 1/16;

gaussian = [1 1 2 1 1; ...
1 2 4 2 1; ...
2 4 8 4 2; ...
1 2 4 2 1; ...
1 1 2 1 1];
gaussianDiv = 1/52;

identity = [ 0  0  0  0 0; ...
0  0  0  0 0; ...
0  0  1  0 0; ...
0  0  0  0 0; ...
0  0  0  0 0];
identityDiv = 1;
    
```

The underlying 5-tap MAC FIR filters are clocked 5 times faster than the input rate. Therefore the throughput of the design is $213 \text{ MHz} / 5 = 42.6$ million pixels/ second. For a 64×64 image, this is $42.6 \times 10^6 / (64 \times 64) = 10,400$ frames/sec. For a 256×256 image the throughput would be 650 frames /sec, and for a 512×512 image it would be 162 frames/sec.

Block Parameters

The block parameters dialog box can be invoked by double-clicking the icon in your Simulink model.

Parameters specific to this reference block are as follows:

- **5x5 Mask:** The coefficients for an Edge, Sobel X, Sobel Y, Sobel X-Y, Blur, Smooth, Sharpen, Gaussian, or Identity filter can be selected.
- **Sample Period:** The sample period at which the input signal runs at is required

BPSK AWGN Channel

The Xilinx BPSK AWGN Channel reference block adds scaled white Gaussian noise to an input signal. The noise is created by the [White Gaussian Noise Generator](#) reference block.

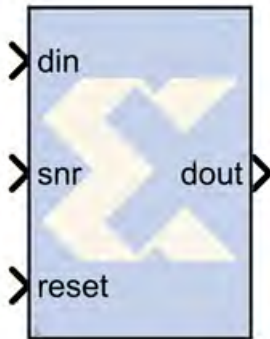

The noise is scaled based on the SNR to achieve the desired noise variance, as shown below. The SNR is defined as (E_b/N_0) in dB for uncoded BPSK with unit symbol energy ($E_s = 1$). The SNR input is UFix8_4 and the valid range is from 0.0 to 15.9375 in steps of 0.0625dB.

To use the AWGN in a system with coding and/or to use the core with different modulation formats, it is necessary to adjust the SNR value to accommodate the difference in spectral efficiency. If we have BPSK modulation with rate 1/2 coding and keep $E_s = 1$ and N_0 constant, then $E_b = 2$ and $E_b/N_0 = \text{SNR} + 3$ dB. If we have uncoded QPSK modulation with $I = +/-1$ and $Q = +/-1$ and add independent noise sequences, then each channel looks like an independent BPSK channel and the $E_b/N_0 = \text{SNR}$. If we then add rate 1/2 coding to the QPSK case, we have $E_b/N_0 = \text{SNR} + 3$ dB.

The overall latency of the AWGN Channel is 15 clock cycles. Channel output is a 17 bit signed number with 11 bits after the binary point. The input port snr can be any type. The reset port must be Boolean and the input port din must be of unsigned 1-bit type with binary point position at zero.

Figure 91: BPSK AWGN Channel Diagram

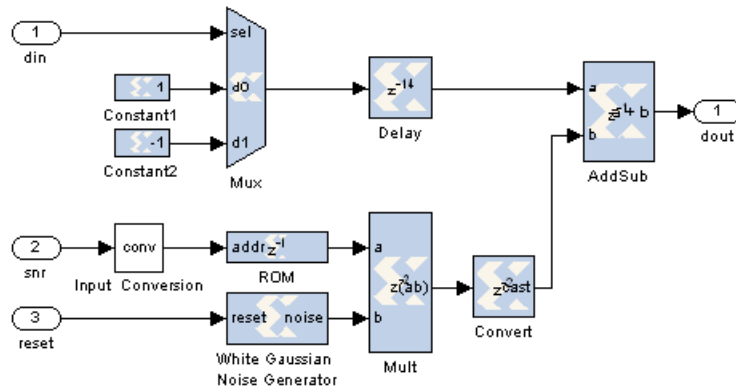

Block Parameters

The block parameter is the decimal starting seed value.

Reference

[1] A. Ghazel, E. Boutillon, J. L. Danger, G. Gulak and H. Laamari, *Design and Performance Analysis of a High Speed AWGN Communication Channel Emulator*, IEEE PACRIM Conference, Victoria, B. C., Aug. 2001.

[2] Xilinx Data Sheet: *Additive White Gaussian Noise (AWGN) Core v1.0*, Xilinx, Inc. October 2002

CIC Filter

Cascaded integrator-comb (CIC) filters are multirate filters used for realizing large sample rate changes in digital systems. Both decimation and interpolation structures are supported. CIC filters contain no multipliers; they consist only of adders, subtractors, and registers. They are typically employed in applications that have a large excess sample rate. That is, the system sample rate is much larger than the bandwidth occupied by the signal. CIC filters are frequently used in digital down-converters and digital up-converters.



Implementation details are provided in the filter design Subsystems. To read the annotations, place the block in a model, then right-click on the block and select **Explore** from the popup menu. Double click on one of the sub-blocks to open the sub-block model and read the annotations.

Block Interface

The CIC Block has a single data input port and a data output port:

- x_n : data input port, can be between 1 and 128 bits (inclusive)
- y_n : data output port

The two basic building blocks of a CIC filter are the integrator and the comb. A single integrator is a single-pole IIR filter with a transfer function of:

$$H(z) = (1 - z^{-1})^{-1}$$

The integrator's unity feedback coefficient is $y[n] = y[n-1] + x[n]$.

A single comb filter is an odd-symmetric FIR filter described by:

$$y[n] = x[n] - x[n - RM]$$

M is the differential delay selected in the block dialog box, and R is the selected integer rate change factor. The transfer function for a single comb stage is

$$H(z) = 1 - z^{-RM}$$

As seen in the two figures below, the CIC filter cascades N integrator sections together with N comb sections. To keep the integrator and comb structures independent of rate change, a rate change block (for example, an up-sampler, or down-sampler) is inserted between the sections. In the interpolator, the up-sampler causes a rate increase by a factor of R by inserting $R-1$ zero-valued samples between consecutive samples of the comb section output. In the decimator, the down-sampler reduces the sample rate by a factor of R by taking sub-samples of the output from the last integrator stage.

Figure 92: CIC Filter

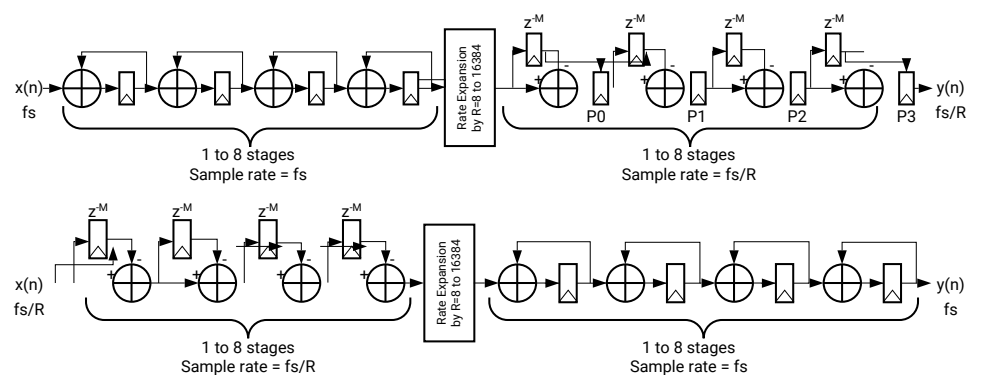

X23232-091919

Block Parameters

The block parameters dialog box can be invoked by double-clicking the icon in your Simulink® model.

Parameters specific to this reference block are as follows:

- **Input Bit Width:** Width of input sample.
- **Input Binary Point:** Binary point location of input.
- **Filter Type:** Interpolator or Decimator
- **Sample Rate Change:** 8 to 16384 (inclusive)
- **Number of Stages:** 1 to 32 (inclusive)
- **Differential Delay:** 1 to 4 (inclusive)
- **Pipeline Differentiators:** On or Off

Reference

E. B. Hogenauer. *An economical class of digital filters for decimation and interpolation*. IEEE Transactions on Acoustics, Speech and Signal Processing, ASSP- 29(2):155{162, 1981

Convolutional Encoder

The Xilinx® Convolutional Encoder Model block implements an encoder for convolutional codes. Ordinarily used in tandem with a Viterbi decoder, this block performs forward error correction (FEC) in digital communication systems.

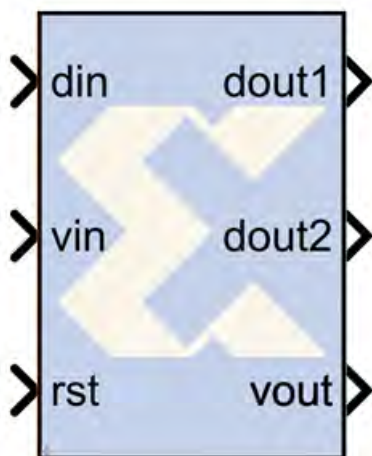

Values are encoded using a linear feed forward shift register which computes modulo-two sums over a sliding window of input data, as shown in the figure below. The length of the shift register is specified by the constraint length. The convolution codes specify which bits in the data window contribute to the modulo-two sum. Resetting the block will set the shift register to zero. The encoder rate is the ratio of input to output bit length; thus, for example a rate 1/2 encoder outputs two bits for each input bit. Similarly, a rate 1/3 encoder outputs three bits for each input bit.

Figure 93: Encoder Rate

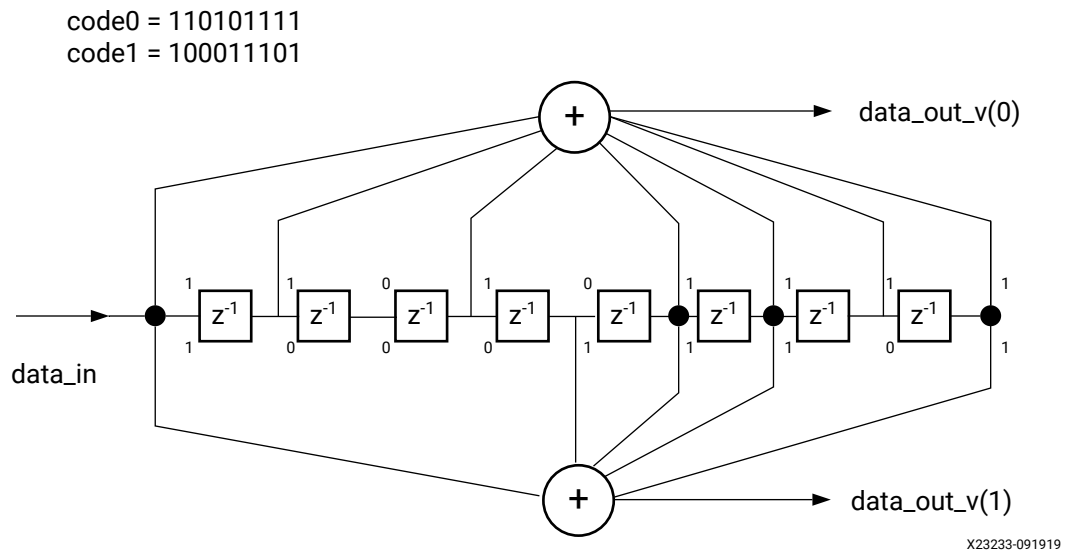

Implementation

The block is implemented using a form of parameterizable mux-based collapsing. In this method constants drive logic blocks. Here the constant is the convolution code which is used to determine which register in the linear feed forward shift register is to be used in computing the output. All logic driven by a constant is optimized away by the down stream logic synthesis tool.

Figure 94: Implementation

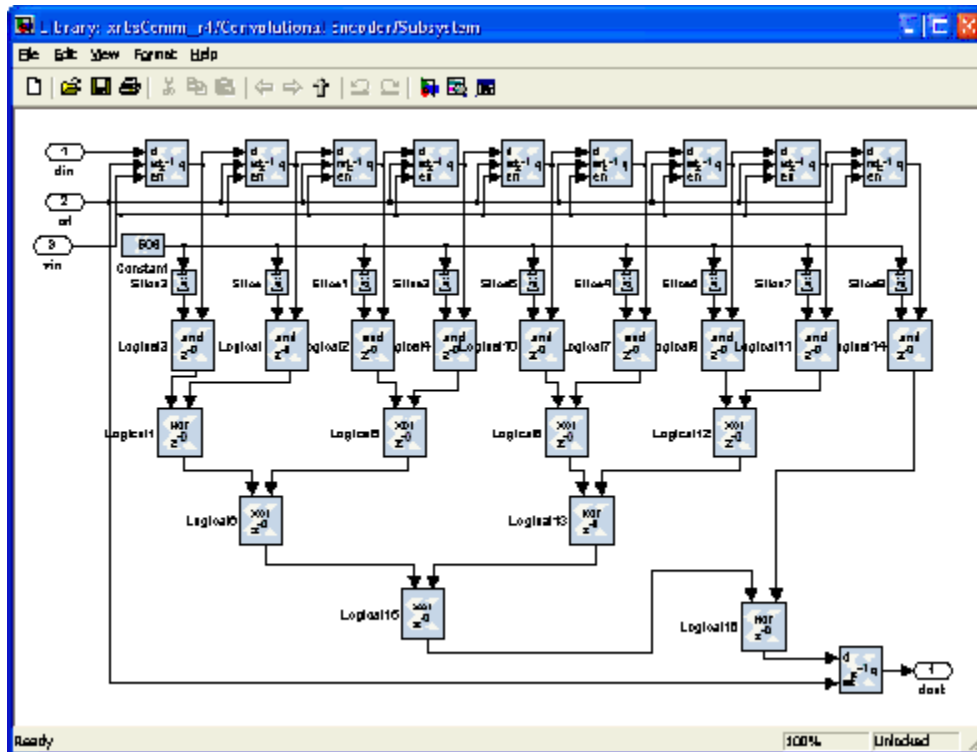

Block Interface

The block currently has three input ports and three output ports. The `din` port must have type `UFix1_0`. It accepts the values to be encoded. The `vin` port indicates that the values presented on `din` are valid. Only valid values are encoded. The `rst` port will reset the convolution encoder when high. To add an enable port, you can open the Subsystem and change the constant "Enable" to an input port. The output ports `dout1` and `dout2` output the encoded data. The port `dout1` corresponds to the first code in the array, `dout2` to the second, and so on. To add additional output ports, open the Subsystem and follow the directions in the model. The output port `vout` indicates the validity of output values.

Block Parameters

The block parameters dialog box can be invoked by double-clicking the icon in your Simulink model.

Parameters specific to this reference block are as follows:

- **Constraint Length:** Equals $n+1$, where n is the length of the constraint register in the encoder
- **Convolutional code array (octal):** Array of octal convolution codes. Output rate is derived from the array length. Between 2 and 7 (inclusive) codes can be entered

CORDIC ATAN

The Xilinx CORDIC ATAN reference block implements a rectangular-to-polar coordinate conversion using a fully parallel CORDIC (COordinate Rotation DIgital Computer) algorithm in Circular Vectoring mode.

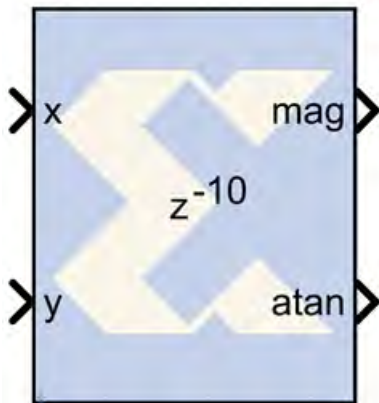

That is, given a complex-input $\langle x, y \rangle$, it computes a new vector $\langle m, a \rangle$, where magnitude $m = K \times \sqrt{x^2 + y^2}$, and the angle $a = \arctan(y/x)$. As is common, the magnitude scale factor $K = 1.646760\dots$ is not compensated in the processor, for example, the magnitude output should be scaled by this factor. The CORDIC processor is implemented using building blocks from the Xilinx blockset.

The CORDIC ATAN algorithm is implemented in the following 3 steps:

1. Coarse Angle Rotation. The algorithm converges only for angles between $-\pi/2$ and $\pi/2$, so if $x < 0$, the input vector is reflected to the 1st or 3rd quadrant by making the x-coordinate non-negative.
2. Fine Angle Rotation. For rectangular-to-polar conversion, the resulting vector is rotated through progressively smaller angles, such that y goes to zero. In the i -th stage, the angular rotation is by either $\pm \arctan(1/2^i)$, depending on whether or not its input y is less than or greater than zero.
3. Angle Correction. If there was a reflection applied in Step 1, this step applies the appropriate angle correction by subtracting it from $\pm \pi$.

Block Parameters

The block parameters dialog box can be invoked by double-clicking the icon in your Simulink model.

Parameters specific to this reference block are as follows:

- **Number of Processing Elements:** specifies the number of iterative stages used for fine angle rotation.
- **X,Y Data Width:** specifies the width of the inputs x and y. The inputs x, and y should be signed data type having the same data width.
- **X,Y Binary Point Position:** specifies the binary point position for inputs x and y. The inputs x and y should be signed data type with the same binary point position.
- **Latency for each Processing element:** This parameter sets the pipeline latency after each circular rotation stage.

The latency of the CORDIC arc tangent block is calculated based on the formula specified as follows: Latency = 3 + sum (latency of Processing Elements)

Reference

- 1) J. E. Volder, *The CORDIC Trigonometric Computing Technique*, IRE Trans. On Electronic Computers, Vol. EC-8, 1959, pp. 330-334.
- 2) J. S. Walther, *A Unified Algorithm for Elementary Functions*, Spring Joint Computer Conference (1971) pp. 379-385.
- 3) Yu Hen Hu, *CORDIC-Based VLSI Architectures for Digital Signal Processing*, IEEE Signal Processing Magazine, pp. 17-34, July 1992.

CORDIC DIVIDER

The Xilinx CORDIC DIVIDER reference block implements a divider circuit using a fully parallel CORDIC (COordinate Rotation Digital Computer) algorithm in Linear Vectoring mode.

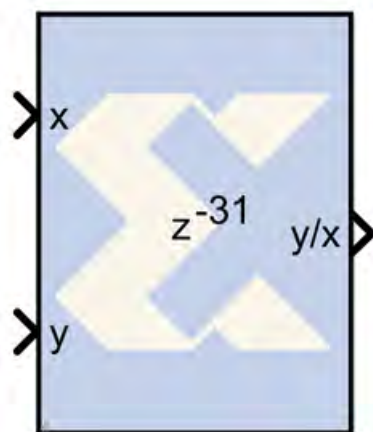

That is, given an input $\langle x, y \rangle$, it computes the output y/x . The CORDIC processor is implemented using building blocks from the Xilinx blockset.

The CORDIC divider algorithm is implemented in the following 4 steps:

1. **Co-ordinate Rotation** - The CORDIC algorithm converges only for positive values of x . The input vector is always mapped to the 1st quadrant by making the x and y coordinate non-negative. The divider circuit has been designed to converge for all values of X and Y , except for the most negative value.
2. **Normalization** - The CORDIC algorithm converges only for y less than or equal to $2x$. The inputs x and y are shifted to the left until they have a 1 in the most significant bit (MSB). The relative shift of y over x is recorded and passed on to the co-ordinate correction stage.
3. **Linear Rotations** - For ratio calculation, the resulting vector is rotated through progressively smaller angles, such that y goes to zero. In the final stage, the rotation yields y/x .
4. **Co-ordinate Correction** - Based on the co-ordinate axis and a relative shift applied to y over x , this step assigns the appropriate sign to the resulting ratio and multiplies it with $2^{(\text{relative shift of } y \text{ over } x)}$.

Block Parameters

The block parameters dialog box can be invoked by double-clicking the icon in your Simulink model.

Parameters specific to this reference block are as follows:

- **Number of Processing Elements** specifies the number of iterative stages used for linear rotation.
- **X,Y Data Width**: specifies the width of the inputs x and y . The inputs x and y should be signed data type with the same data width.
- **X,Y Binary Point Position**: specifies the binary point position for inputs x and y . The inputs x and y should be signed data type with the same binary point position.
- **Latency for each Processing element**: This parameter sets the pipeline latency after each iterative linear rotation stage.

The latency of the CORDIC divider block is calculated based on the formula specified as follows:
 Latency = 4 + data width + sum (latency of Processing Elements)

Reference

1. J. E. Volder, *The CORDIC Trigonometric Computing Technique*, IRE Trans. On Electronic Computers, Vol. EC-8, 1959, pp. 330-334.
2. J. S. Walther, *A Unified Algorithm for Elementary Functions*, Spring Joint Computer Conference (1971) pp. 379-385.

3. Yu Hen Hu, *CORDIC-Based VLSI Architectures for Digital Signal Processing*, IEEE Signal Processing Magazine, pp. 17-34, July 1992.

CORDIC LOG

The Xilinx CORDIC LOG reference block implements a natural logarithm circuit using a fully parallel CORDIC (COordinate Rotation Digital Computer) algorithm in Hyperbolic Vectoring mode.

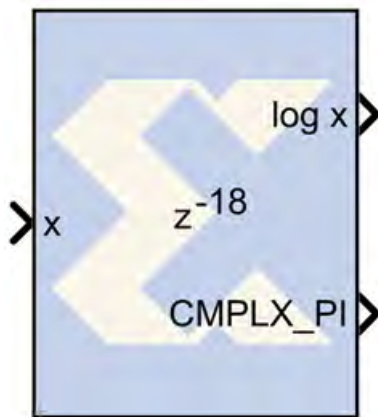

That is, given an input x , it computes the output $\log(x)$ and also provides a flag for adding complex pi value to the output if a complex output is desired. The CORDIC processor is implemented using building blocks from the Xilinx blockset.

The natural logarithm is calculated indirectly by the CORDIC algorithm by applying the identities listed below.

$$\log(w) = 2 \times \tanh^{-1}[(w-1) / (w+1)]$$

$$\log(w \times 2^E) = \log(w) + E \times \log(2)$$

The CORDIC LOG algorithm is implemented in the following 4 steps:

1. **Co-ordinate Rotation:** The CORDIC algorithm converges only for positive values of x . If $x < 0$, the input data is converted to a non-negative number. If $x = 0$, a zero detect flag is passed along to the last stage which can be exposed at the output stage. The log circuit has been designed to converge for all values of x , except for the most negative value.
2. **Normalization:** The CORDIC algorithm converges only for x , between the values 0.5 (inclusive) and 1. During normalization, the input X is shifted to the left till it has a 1 in the most significant bit. The log output is derived using the identity $\log(w) = 2 \times \tanh^{-1}\{(w-1) / (w+1)\}$. Based on this identity, the input w gets mapped to, $x = w + 1$ and $y = w - 1$.

3. **Linear Rotations:** For $\tanh^{-1}\{(w-l) / (w+1)\}$ calculation, the resulting vector is rotated through progressively smaller angles, such that y goes to zero.
4. **Co-ordinate Correction:** If the input was negative a CMPLX_PI flag is provided at the output for adding PI if a complex output is desired. If a left shift was applied to X, this step adjusts the output by using the equation $\log(w \times 2^E) = \log(w) + E \times \log(2)$.

Block Parameters

The block parameters dialog box can be invoked by double-clicking the icon in your Simulink model.

Parameters specific to this reference block are as follows:

- **Number of Processing Elements (integer value starting from 1):** specifies the number of iterative stages used for hyperbolic rotation.
- **Input Data Width:** specifies the width of input x. The inputs x should be signed data type having the same data width.
- **Input Binary Point Position:** specifies the binary point position for input x. The input x should be signed data type with the same binary point position.
- **Latency for each Processing Element [1001]:** This parameter sets the pipeline latency after each circular rotation stage.

The latency of the CORDIC LOG block is calculated based on the formula specified as follows:
 Latency = 2 + Data Width + sum (latency of Processing Elements).

Reference

1. J. E. Volder, *The CORDIC Trigonometric Computing Technique*, IRE Trans. On Electronic Computers, Vol. EC-8, 1959, pp. 330-334.
2. J. S. Walther, *A Unified Algorithm for Elementary Functions*, Spring Joint Computer Conference (1971) pp. 379-385.
3. Yu Hen Hu, *CORDIC-Based VLSI Architectures for Digital Signal Processing*, IEEE Signal Processing Magazine, pp. 17-34, July 1992.

CORDIC SINCOS

The Xilinx CORDIC SINCOS reference block implements Sine and Cosine generator circuit using a fully parallel CORDIC (COordinate Rotation DIgital Computer) algorithm in Circular Rotation mode.

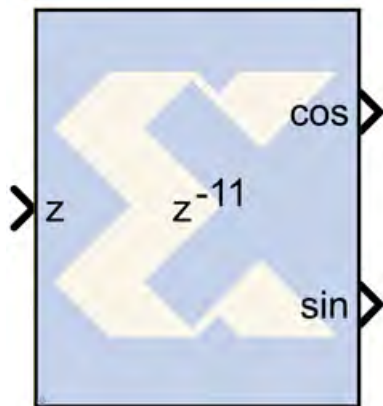

That is, given input angle z , it computes the output cosine (z) and sine (z). The CORDIC processor is implemented using building blocks from the Xilinx blockset. The CORDIC sine cosine algorithm is implemented in the following 3 steps:

1. Coarse Angle Rotation - The algorithm converges only for angles between $-\pi/2$ and $\pi/2$. If $z > \pi/2$, the input angle is reflected to the 1st quadrant by subtracting $\pi/2$ from the input angle. When $z < -\pi/2$, the input angle is reflected back to the 3rd quadrant by adding $\pi/2$ to the input angle. The sine cosine circuit has been designed to converge for all values of z , except for the most negative value.
2. Fine Angle Rotation - By setting x equal to $1/1.646760$ and y equal to 0 , the rotational mode CORDIC processor yields cosine and sine of the input angle z .
3. Co-ordinate Correction - If there was a reflection applied in Step 1, this step applies the appropriate correction.

For $z > \pi/2$: using $z = t + \pi/2$, then

$$\sin(z) = \sin(t) \cdot \cos(\pi/2) + \cos(t) \cdot \sin(\pi/2) = \cos(t)$$

$$\cos(z) = \cos(t) \cdot \cos(\pi/2) - \sin(t) \cdot \sin(\pi/2) = -\sin(t)$$

For $z < -\pi/2$: using $z = t - \pi/2$, then

$$\sin(z) = \sin(t) \cdot \cos(-\pi/2) + \cos(t) \cdot \sin(-\pi/2) = -\cos(t)$$

$$\cos(z) = \cos(t) \cdot \cos(-\pi/2) - \sin(t) \cdot \sin(-\pi/2) = \sin(t)$$

Block Parameters

The block parameters dialog box can be invoked by double-clicking the icon in your Simulink model.

Parameters specific to this reference block are as follows:

- **Number of Processing Elements:** specifies the number of iterative stages used for linear rotation.

- **Input Data Width:** specifies the width of the input z . The input z should be signed data type with the same data width as specified.
- **Input Binary Point Position:** specifies the binary point position for input z . The input z should be signed data type with the same binary point position. The binary point should be chosen to provide enough bits for representing $\pi/2$.
- **Latency for each Processing element:** This parameter sets the pipeline latency after each iterative circular rotation stage. The latency of the CORDIC SINCOS block is calculated based on the formula specified as follows: Latency = 3 + sum (latency of Processing Elements)

Reference

1) J. E. Volder, *The CORDIC Trigonometric Computing Technique*, IRE Trans. On Electronic Computers, Vol. EC-8, 1959, pp. 330-334. 2) J. S. Walther, *A Unified Algorithm for Elementary Functions*, Spring Joint Computer Conference (1971) pp. 379-385. 3) Yu Hen Hu, *CORDIC-Based VLSI Architectures for Digital Signal Processing*, IEEE Signal Processing Magazine, pp. 17-34, July 1992.

CORDIC SQRT

The Xilinx CORDIC SQRT reference block implements a square root circuit using a fully parallel CORDIC (COordinate Rotation Digital Computer) algorithm in Hyperbolic Vectoring mode.

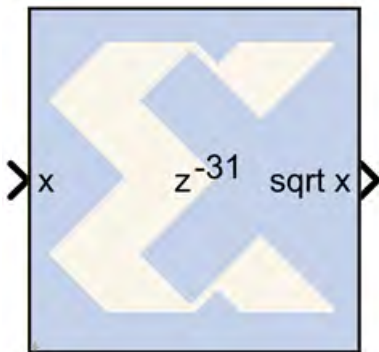

That is, given input x , it computes the output $\text{sqrt}(x)$. The CORDIC processor is implemented using building blocks from the Xilinx blockset.

The square root is calculated indirectly by the CORDIC algorithm by applying the identity listed as follows. $\text{sqrt}(w) = \text{sqrt} \{ (w + 0.25)^2 - (w - 0.25)^2 \}$

The CORDIC square root algorithm is implemented in the following 4 steps:

1. **Co-ordinate Rotation:** The CORDIC algorithm converges only for positive values of x . If $x < 0$, the input data is converted to a non-negative number. If $x = 0$, a zero detect flag is passed to the co-ordinate correction stage. The square root circuit has been designed to converge for all values of x , except for the most negative value.
2. **Normalization:** The CORDIC algorithm converges only for x between 0.25 (inclusive) and 1. During normalization, the input x is shifted to the left till it has a 1 in the most significant non-signed bit. If the left shift results in an odd number of shift values, a right shift is performed resulting in an even number of left shifts. The shift value is divided by 2 and passed on to the co-ordinate correction stage. The square root is derived using the identity $\text{sqrt}(w) = \text{sqrt}\{(w + 0.25)^2 - (w - 0.25)^2\}$. Based on this identity the input x gets mapped to, $X = x + 0.25$ and $Y = x - 0.25$.
3. **Hyperbolic Rotations:** For $\text{sqrt}(X^2 - Y^2)$ calculation, the resulting vector is rotated through progressively smaller angles, such that Y goes to zero.
4. **Co-ordinate Correction:** If the input was negative and a left shift was applied to x , this step assigns the appropriate sign to the output and multiplies it with $2^{-\text{shift}}$. If the input was zero, the zero detect flag is used to set the output to 0.

Block Parameters

The block parameters dialog box can be invoked by double-clicking the icon in your Simulink model.

Parameters specific to this reference block are as follows:

- **Number of Processing Elements (integer value starting from 1):** specifies the number of iterative stages used for linear rotation.
- **Input Data Width:** specifies the width of the inputs x . The input x should be signed data type with the same data width as specified.
- **Input Binary Point Position:** specifies the binary point position for input x . The input x should be signed data type with the specified binary point position.
- **Latency for each Processing Element [1001]:** This parameter sets the pipeline latency after each iterative hyperbolic rotation stage.

The latency of the CORDIC square root block is calculated based on the formula specified below:

$$\begin{aligned} \text{Latency} &= 7 + (\text{data width} - \text{binary point}) \\ &+ \text{mod}\{(\text{data width} - \text{binary point}), 2\} \\ &+ \text{sum}(\text{latency of Processing Elements}) \end{aligned}$$

Reference

- 1) J. E. Volder, *The CORDIC Trigonometric Computing Technique*, IRE Trans. On Electronic Computers, Vol. EC-8, 1959, pp. 330-334.

- 2) J. S. Walther, *A Unified Algorithm for Elementary Functions*, Spring Joint Computer Conference (1971) pp. 379-385.
- 3) Yu Hen Hu, *CORDIC-Based VLSI Architectures for Digital Signal Processing*, IEEE Signal Processing Magazine, pp. 17-34, July 1992.

Dual Port Memory Interpolation MAC FIR Filter

The Xilinx Dual Port Memory Interpolation MAC FIR filter reference block implements a multiply-accumulate-based FIR filter to perform a user-selectable interpolation. One dedicated multiplier and one Dual Port Block RAM are used in the n-tap filter. The filter configuration helps illustrate a cyclic RAM buffer technique for storing coefficients and data samples in a single block ram. The filter allows users to select the interpolation factor they require. The Virtex FPGA family (and Virtex family derivatives) provide dedicated circuitry for building fast, compact adders, multipliers, and flexible memory architectures. The filter design takes advantage of these silicon features by implementing a design that is compact and resource-efficient.

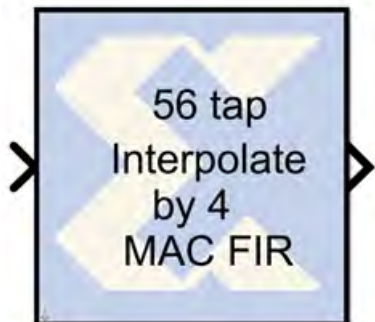

Implementation details are provided in the filter design Subsystems. To read the annotations, place the block in a model, then right-click on the block and select **Explore** from the popup menu. Double click on one of the sub-blocks to open the sub-block model and read the annotations.

Block Parameters

The block parameters dialog box can be invoked by double-clicking the icon in your Simulink model.

Parameters specific to this reference block are as follows:

- **Data Input Bit Width:** Width of input sample.
- **Data Input Binary Point:** Binary point location of input.

- **Coefficients:** Specify coefficients for the filter. Number of taps is inferred from size of coefficient vector.
- **Number of Bits per Coefficient:** Bit width of each coefficient.
- **Binary Point Per Coefficient:** Binary point location for each coefficient.
- **Interpolation Ratio:** Select the Interpolation Ratio of the filter (2 to 10, inclusive).
- **Sample Period:** Sample period of input.

Reference

J. Hwang and J. Ballagh. *Building Custom FIR Filters Using System Generator*. 12th International Field-Programmable Logic and Applications Conference (FPL). Montpellier, France, September 2002. Lecture Notes in Computer Science 2438.

Interpolation Filter

The Xilinx n-tap Interpolation Filter reference block implements a multiply-accumulate-based FIR filter to perform a user selected interpolation. One dedicated multiplier and one Dual Port Block RAM are used in the n-tap filter. The filter configuration helps illustrate a cyclic RAM buffer technique for storing coefficients and data samples in a single block ram. The filter allows users to select the interpolation factor they require. The Virtex FPGA family (and Virtex family derivatives) provide dedicated circuitry for building fast, compact adders, multipliers, and flexible memory architectures. The filter design takes advantage of these silicon features by implementing a design that is compact and resource efficient.

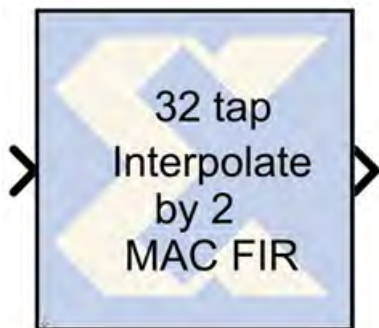

Implementation details are provided in the filter design Subsystems. To read the annotations, place the block in a model, then right-click on the block and select **Explore** from the popup menu. Double click on one of the sub-blocks to open the sub-block model and read the annotations.

Block Parameters

The block parameters dialog box can be invoked by double-clicking the icon in your Simulink model.

Parameters specific to this reference block are as follows:

- **Input Data Bit Width:** Width of input sample.
- **Input Data Binary Point:** Binary point location of input.
- **Coefficients:** Specify coefficients for the filter. Number of taps is inferred from size of coefficient vector.
- **Number of Bits per Coefficient:** Bit width of each coefficient.
- **Binary Point per Coefficient:** Binary point location for each coefficient.
- **Interpolation Factor:** Select the Interpolation Ratio of the filter. Range from 2 to 10.
- **Sample Period:** Sample period of input.

Reference

J. Hwang and J. Ballagh. *Building Custom FIR Filters Using System Generator*. 12th International Field-Programmable Logic and Applications Conference (FPL). Montpellier, France, September 2002. Lecture Notes in Computer Science 2438

m-channel n-tap Transpose FIR Filter

The Xilinx m-channel n-tap Transpose FIR Filter uses a fully parallel architecture with Time Division Multiplexing. The Virtex FPGA family (and Virtex family derivatives) provide dedicated shift register circuitry called the SRL16E, which are exploited in the architecture to achieve optimal implementation of the multichannel architecture. The Time Division Multiplexer and Time Division Demux can be selected to be implemented or not. Embedded Multipliers are used for the multipliers.

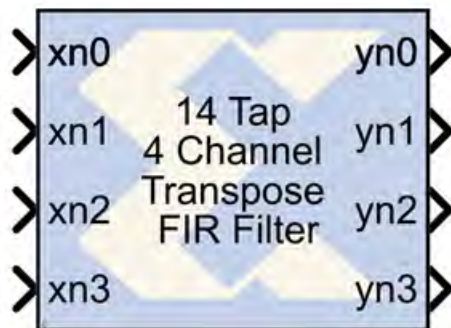

As the number of coefficients changes so to does the structure underneath as it is a dynamically built model.

Implementation details are provided in the filter design Subsystems. To read the annotations, place the block in a model, then right-click on the block and select **Explore** from the popup menu. Double click on one of the sub-blocks to open the sub-block model and read the annotations.

Block Parameters

The block parameters dialog box can be invoked by double-clicking the icon in your Simulink model.

Parameters specific to this reference block are as follows:

- **Input Bit Width:** Width of input sample.
- **Input Binary Point:** Binary point location of input.
- **Coefficients:** Specify coefficients for the filter. Number of taps is inferred from size of coefficient vector.
- **Coefficients Bit Width:** Bit width of each coefficient.
- **Coefficients Binary Point:** Binary point location for each coefficient.
- **Number of Channels:** Specify the number of channels desired. There is no limit to the number of channels supported.
- **Time Division Multiplexer Front End:** The TDM front-end circuit can be implemented or not (if the incoming data is already TDM)
- **Time Division DeMultiplexer Back End:** The TDD back-end circuit can be implemented or not (if you desire a TDM output). This is useful if the filter feeds another multichannel structure.
- **Input Sample Period:** Sample period of input.

Mealy State Machine

A “Mealy machine” is a finite state machine whose output is a function of state transition, for example, a function of the machine’s current state and current input. A Mealy machine can be described with the following block diagram:

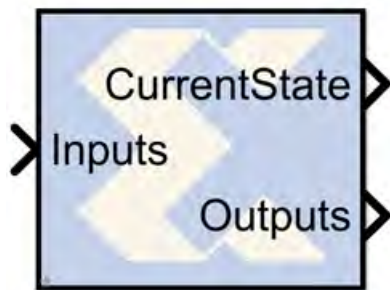
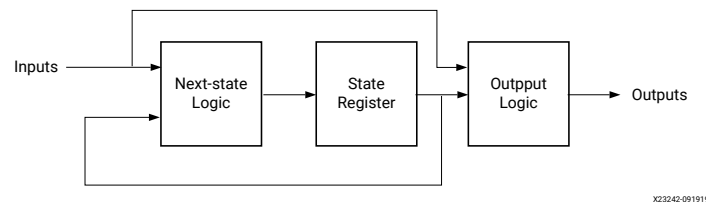

Figure 95: Mealy Machine Block Diagram



X23242-091919

There are many ways to implement such state machines in System Generator (e.g., using the MCode block to implement the transition function, and registers to implement state variables). This reference block provides a method for implementing a Mealy machine using block and distributed memory. The implementation is very fast and efficient. For example, a state machine with 8 states, 1 input, and 2 outputs that are registered can be realized with a single block RAM that runs at more than 150 MHz in a Xilinx Virtex device.

The transition function and output mapping are each represented as an $N \times M$ matrix, where N is the number of states, and M is the size of the input alphabet (e.g., $M = 2$ for a binary input). It is convenient to number rows and columns from 0 to $N - 1$ and 0 to $M - 1$ respectively. Each state is represented as an unsigned integer from 0 to $N - 1$, and each alphabet character is represented as an unsigned integer from 0 to $M - 1$. The row index of each matrix represents the current state, and the column index represents the input character

For the purpose of discussion, let F be the $N \times M$ transition function matrix, and O be the $N \times M$ output function matrix. Then $F(i,j)$ is the next state when the current state is i and the current input character is j , and $O(i,j)$ is the corresponding output of the Mealy machine.

Example

Consider the problem of designing a Mealy machine to recognize the pattern '1011' in a serial stream of bits. The state transition diagram and equivalent transition table are shown below.

Figure 96: State Transition Diagram

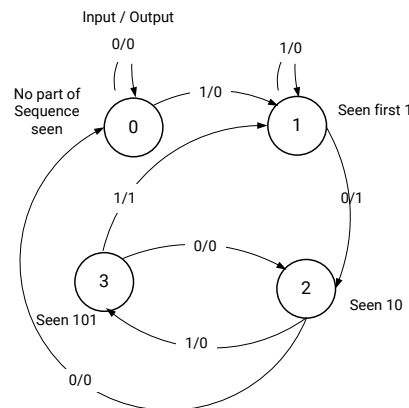

Next State/Output Table

Current State	If Input = 0	If Input = 1
0	0, 0	1, 0
1	2, 0	1, 0
2	0, 0	3, 0
3	2, 0	1, 1

Cell Format : Next State, Output

X2258-092019

The table lists the next state and output that result from the current state and input. For example, if the current state is 3 and the input is 1, the next state is 1 and the output is 1, indicating the detection of the desired sequence.

The Mealy State Machine block is configured with next state and output matrices obtained from the next state/output table discussed above. These matrices are constructed as shown below:

Figure 97: Next State Output Table

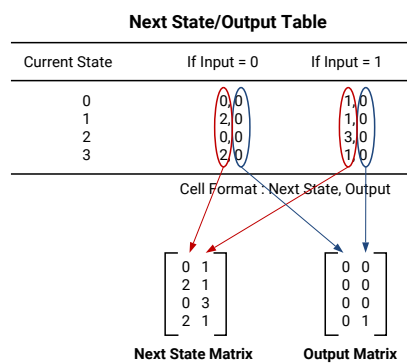

X2257-092019

Block Parameters

The block parameters dialog box can be invoked by double-clicking the icon in your Simulink model.

The next state logic, state register, and output logic are implemented using high speed dedicated block RAM. The output logic is implemented using a distributed RAM configured as a lookup table, and therefore has zero latency.

The number of bits used to implement a Mealy state machine is given by the equations:

$$\text{depth} = (2^k)(2^i) = 2^{k+i}$$

$$\text{width} = k+o$$

$$N = \text{depth} * \text{width} = (k+o)(2^{k+i})$$

where

N = total number of block RAM bits

s = number of states

k = $\text{ceil}(\log_2(s))$

i = number of input bits

o = number of output bits

The following table gives examples of block RAM sizes necessary for various state machines:

Table 24: Block RAM Sizes

Number of States	Number of Input Bits	Number of Output Bits	Block RAM Bits Needed
2	5	10	704
4	1	2	32
8	6	7	5120
16	5	4	4096
32	4	3	4096
52	1	11	2176
100	4	5	24576

The block RAM width and depth limitations are described in the online help for the Single Port RAM block.

Moore State Machine

A "Moore machine" is a finite state machine whose output is only a function of the machine's current state. A Moore state machine can be described with the following block diagram:

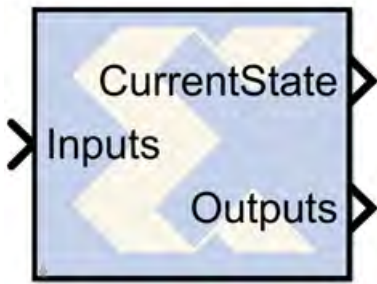
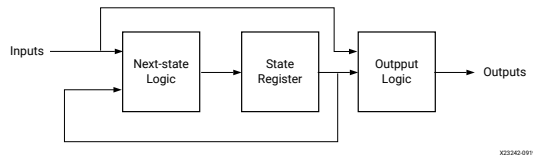

Figure 98: Moore State Machine Block Diagram



There are many ways to implement such state machines in System Generator (e.g., using the MCode block to implement the transition function, and registers to implement state variables). This reference block provides a method for implementing a Moore machine using block and distributed memory. The implementation is very fast and efficient. For example, a state machine with 8 states, 1 input, and 2 outputs that are registered can be realized with a single block RAM that runs at more than 150 MHz in a Xilinx Virtex device.

The transition function and output mapping are each represented as an $N \times M$ matrix, where N is the number of states, and M represents the number of possible input values (e.g., $M = 2$ for a one bit input). It is convenient to number rows and columns from 0 to $N - 1$ and 0 to $M - 1$ respectively. Each state is represented as an unsigned integer from 0 to $N - 1$, and each alphabet character is represented as an unsigned integer from 0 to $M - 1$. The row index of each matrix represents the current state, and the column index represents the input character.

For the purpose of discussion, let F be the $N \times M$ transition function matrix, and O be the $N \times M$ output function matrix. Then $F(i,j)$ is the next state when the current state is i and the current input character is j , and $O(i,j)$ is the corresponding output of the Moore machine.

Example

Consider the problem of designing a Moore machine to recognize the pattern '1011' in a serial stream of bits. The state transition diagram and equivalent transition table are shown below:

Figure 99: State Transition Table

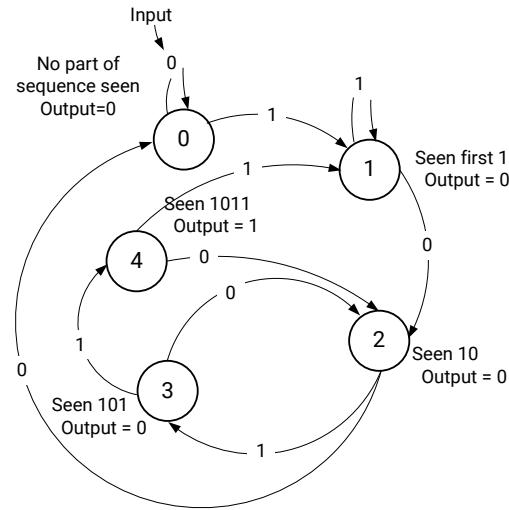

Next State/Output Table

Current State	If Input = 0	If Input = 1	Output
0	0	1	0
1	2	1	0
2	0	3	0
3	2	4	0
4	2	1	1

X23252-092619

The table lists the next state and output that result from the current state and input. For example, if the current state is 4, the output is 1 indicating the detection of the desired sequence, and if the input is 1 the next state is state 1.

The Registered Moore State Machine block is configured with next state matrix and output array obtained from the next state/output table discussed above. They are constructed as follows:

Figure 100: Next State Output Table

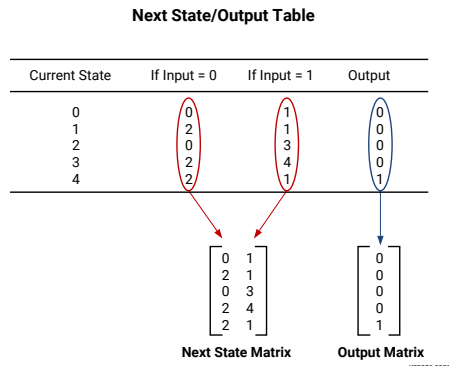

The rows of the matrices correspond to the current state. The next state matrix has one column for each input value. The output array has only one column since the input value does not affect the output of the state machine.

Block Parameters

The block parameters dialog box can be invoked by double-clicking the icon in your Simulink model.

The next state logic and state register in this block are implemented with high speed dedicated block RAM. The output logic is implemented using a distributed RAM configured as a lookup table, and therefore has zero latency.

The number of bits used to implement a Moore state machine is given by the equations:

$$d_s = (2^k)(2^i) = 2^{k+i}$$

$$w_s = k$$

$$N_s = d_s * w_s = (k)(2^{k+i})$$

where

N_s = total number of next state logic block RAM bits

s = number of states

$$k = \text{ceil}(\log_2(s))$$

i = number of input bits

d_s = depth of state logic block RAM

w_s = width of state logic block RAM

The following table gives examples of block RAM sizes necessary for various state machines:

Table 25: Block RAM Sizes

Number of States	Number of Input Bits	Block RAM Bits Needed
2	5	64
4	1	8
8	6	1536
16	5	2048
32	4	2560
52	1	768
100	4	14336

The block RAM width and depth limitations are described in the core datasheet for the Single Port Block Memory.

n-tap Dual Port Memory MAC FIR Filter

The Xilinx n-tap Dual Port Block RAM MAC FIR Filter reference block implements a multiply-accumulate-based FIR filter. One dedicated multiplier and one dual port block RAM are used in the filter. The filter configuration illustrates a technique for storing coefficients and data samples in filter design. The Virtex FPGA family (and Virtex family derivatives) provide dedicated circuitry for building fast, compact adders, multipliers, and flexible memory architectures. The filter design takes advantage of these silicon features by implementing a design that is compact and resource efficient.



Implementation details are provided in the filter design Subsystems. To read the annotations, place the block in a model, then right-click on the block and select **Explore** from the popup menu. Double click on one of the sub-blocks to open the sub-block model and read the annotations.

Block Parameters

The block parameters dialog box can be invoked by double-clicking the icon in your Simulink model.

Parameters specific to this reference block are as follows:

- **Data Input Bit Width:** Width of input sample.
- **Data Input Binary Point:** Binary point location of input.
- **Coefficients:** Specify coefficients for the filter. Number of taps is inferred from size of coefficient vector.
- **Number of Bits per Coefficient:** Bit width of each coefficient.
- **Binary Point per Coefficient:** Binary point location for each coefficient.
- **Sample Period:** Sample period of input.

Reference

- J. Hwang and J. Ballagh. *Building Custom FIR Filters Using System Generator*. 12th International Field-Programmable Logic and Applications Conference (FPL). Montpellier, France, September 2002. Lecture Notes in Computer Science 2438

n-tap MAC FIR Filter

The Xilinx n-tap MAC FIR Filter reference block implements a multiply-accumulate-based FIR filter. The three filter configurations help illustrate the trade-offs between filter throughput and device resource consumption. The Virtex FPGA family (and Virtex family derivatives) provide dedicated circuitry for building fast, compact adders, multipliers, and flexible memory architectures. Each filter design takes advantage of these silicon features by implementing a design that is compact and resource efficient.



Implementation details are provided in the filter design Subsystems. To read the annotations, place the block in a model, then right-click on the block and select **Explore** from the popup menu. Double click on one of the sub-blocks to open the sub-block model and read the annotations.

Block Parameters

The block parameters dialog box can be invoked by double-clicking the icon in your Simulink model.

Parameters specific to this reference block are as follows:

- **Coefficients:** Specify coefficients for the filter. Number of taps is inferred from size of coefficient vector.
- **Number of Bits per Coefficient:** Bit width of each coefficient.
- **Binary Point for Coefficient:** Binary point location for each coefficient.
- **Number of Bits per Input Sample:** Width of input sample.
- **Binary Point for Input Samples:** Binary point location of input.
- **Input Sample Period:** Sample period of input.

Reference

[1] J. Hwang and J. Ballagh. *Building Custom FIR Filters Using System Generator*. 12th International Field-Programmable Logic and Applications Conference (FPL). Montpellier, France, September 2002. Lecture Notes in Computer Science 2438

Registered Mealy State Machine

A "Mealy machine" is a finite state machine whose output is a function of state transition, for example, a function of the machine's current state and current input. A "registered Mealy machine" is one having registered output, and can be described with the following block diagram:

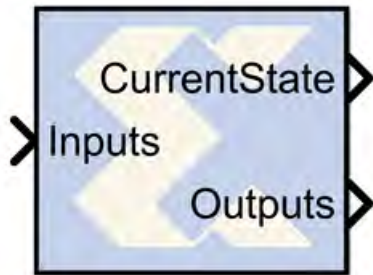
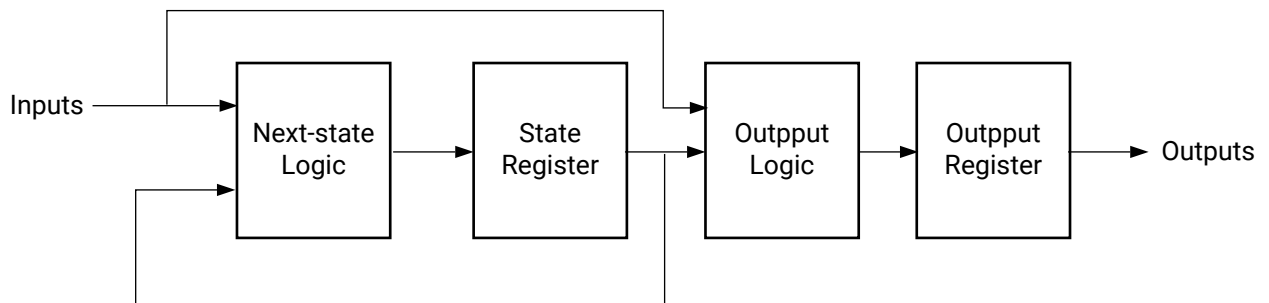

Figure 101: Mealy State Machine Block Diagram



X23244-091919

There are many ways to implement such state machines in System Generator (e.g., using the MCode block to implement the transition function, and registers to implement state variables). This reference block provides a method for implementing a Mealy machine using block and distributed memory. The implementation is very fast and efficient. For example, a state machine with 8 states, 1 input, and 2 outputs that are registered can be realized with a single block RAM that runs at more than 150 MHz in a Xilinx Virtex device.

The transition function and output mapping are each represented as an $N \times M$ matrix, where N is the number of states, and M is the size of the input alphabet (e.g., $M = 2$ for a binary input). It is convenient to number rows and columns from 0 to $N - 1$ and 0 to $M - 1$ respectively. Each state is represented as an unsigned integer from 0 to $N - 1$, and each alphabet character is represented as an unsigned integer from 0 to $M - 1$. The row index of each matrix represents the current state, and the column index represents the input character

For the purpose of discussion, let F be the $N \times M$ transition function matrix, and O be the $N \times M$ output function matrix. Then $F(i, j)$ is the next state when the current state is i and the current input character is j , and $O(i, j)$ is the corresponding output of the Mealy machine.

Example

Consider the problem of designing a Mealy machine to recognize the pattern '1011' in a serial stream of bits. The state transition diagram and equivalent transition table are shown below.

Figure 102: Transition Table

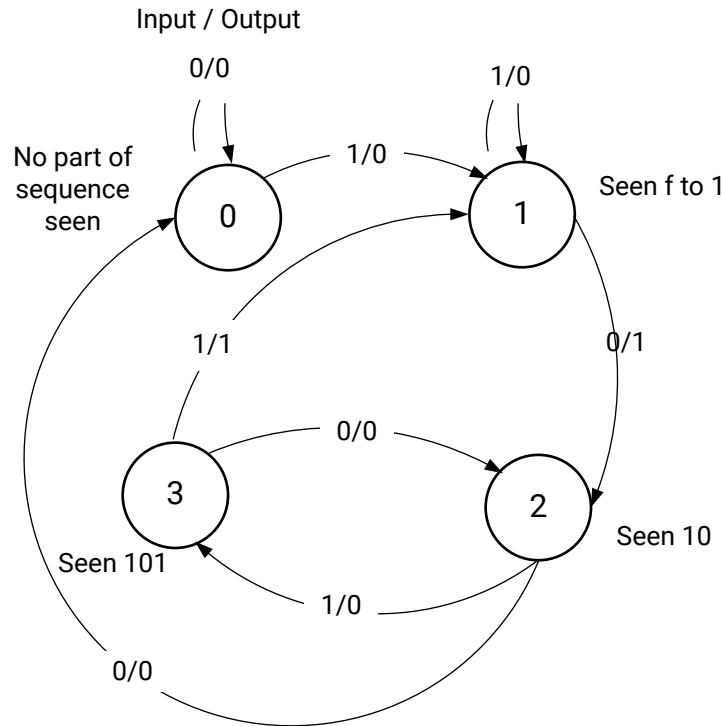

Next State/Output Table

Current State	If Input = 0	If Input = 1
0	0, 0	1, 0
1	2, 0	1, 0
2	0, 0	3, 0
3	2, 0	1, 1

Cell Format : Next State, Output

X23254-092019

The table lists the next state and output that result from the current state and input. For instance, if the current state is 3 and the input is 1, the next state is 1 and the output is 1, indicating the detection of the desired sequence.

The Registered Mealy State Machine block is configured with next state and output matrices obtained from the next state/output table discussed above. These matrices are constructed as shown below:

Figure 103: Next State Output Table

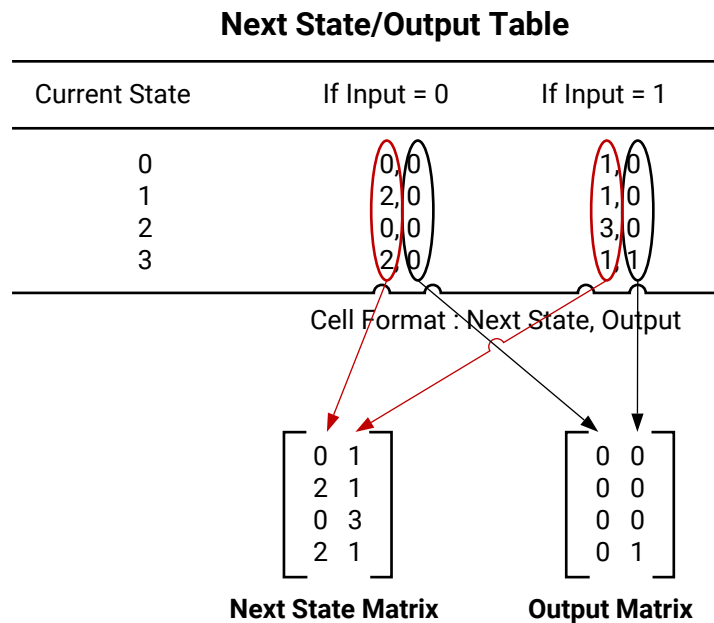

X23255-092019

Rows of the matrices correspond to states, and columns correspond to input values.

Block Parameters

The block parameters dialog box can be invoked by double-clicking the icon in your Simulink model.

The next state logic, state register, output logic, and output register are implemented using high speed dedicated block RAM. Of the four blocks in the state machine library, this is the fastest and most area efficient. However, the output is registered and thus the input does not affect the output instantaneously.

The number of bits used to implement a Mealy state machine is given by the equations:

$$\text{depth} = (2^k)(2^i) = 2^{k+i}$$

$$\text{width} = k+o$$

$$N = \text{depth} * \text{width} = (k+o)(2^{k+i})$$

where

N = total number of block RAM bits

s = number of states

k = $\text{ceil}(\log_2(s))$

i = number of input bits

o = number of output bits

The following table gives examples of block RAM sizes necessary for various state machines:

Table 26: State Machine block RAM Requirements

Number of States	Number of Input Bits	Number of Output Bits	Block RAM Bits Needed
2	5	10	704
4	1	2	32
8	6	7	5120
16	5	4	4096
32	4	3	4096
52	1	11	2176
100	4	5	24576

Registered Moore State Machine

A "Moore machine" is a finite state machine whose output is only a function of the machine's current state. A "registered Moore machine" is one having registered output, and can be described with the following block diagram:

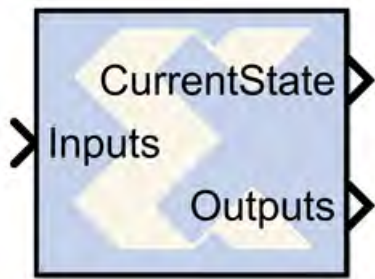
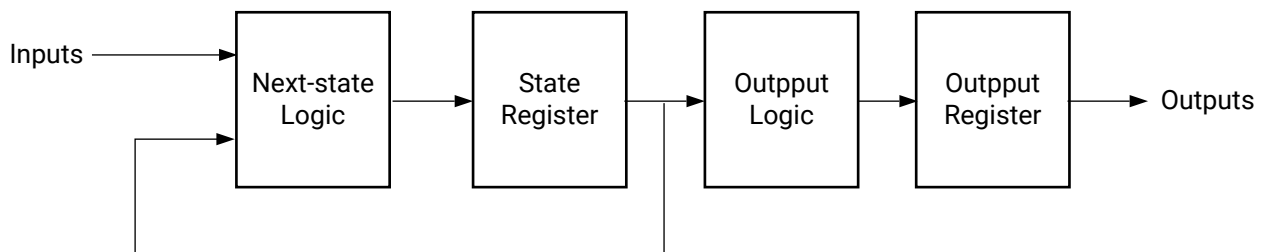

Figure 104: Moore State Machine Block Diagram



X23243-091919

There are many ways to implement such state machines in System Generator, e.g., using the Mcode block. This reference block provides a method for implementing a Moore machine using block and distributed memory. The implementation is very fast and efficient. For example, a state machine with 8 states, 1 input, and 2 outputs that are registered can be realized with a single block RAM that runs at more than 150 MHz in a Xilinx Virtex device.

The transition function and output mapping are each represented as an $N \times M$ matrix, where N is the number of states, and M is the size of the input alphabet (e.g., $M = 2$ for a binary input). It is convenient to number rows and columns from 0 to $N - 1$ and 0 to $M - 1$ respectively. Each state is represented as an unsigned integer from 0 to $N - 1$, and each alphabet character is represented as an unsigned integer from 0 to $M - 1$. The row index of each matrix represents the current state, and the column index represents the input character.

For the purpose of discussion, let F be the $N \times M$ transition function matrix, and O be the $N \times M$ output function matrix. Then $F(i, j)$ is the next state when the current state is i and the current input character is j , and $O(i, j)$ is the corresponding output of the Mealy machine.

Example

Consider the problem of designing a Moore machine to recognize the pattern '1011' in a serial stream of bits. The state transition diagram and equivalent transition table are shown below.

Figure 105: Transition Table

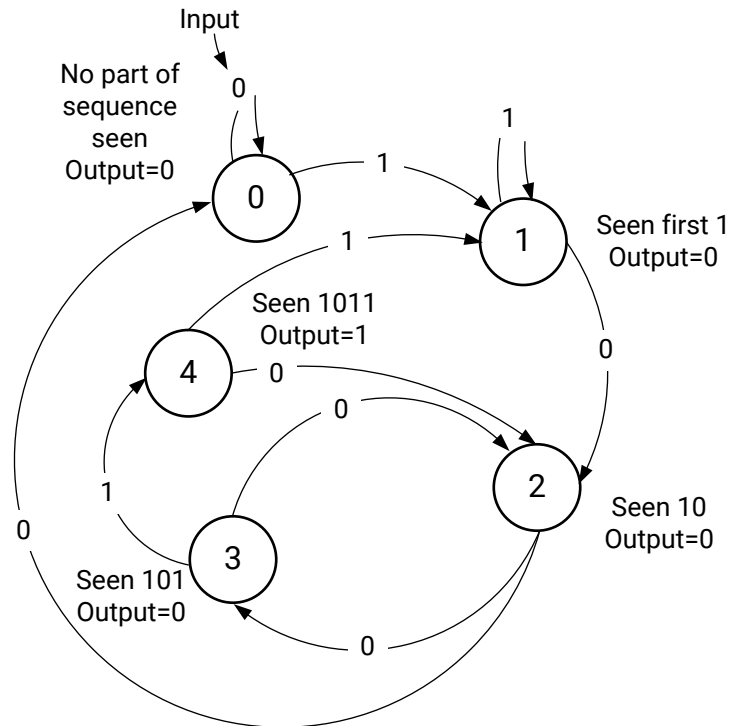

Next State/Output Table

Current State	If Input = 0	If Input = 1	Output
0	0	1	0
1	2	1	0
2	0	3	0
3	2	4	0
4	2	1	1

X23256-092019

The table lists the next state and output that result from the current state and input. For example, if the current state is 4, the output is 1 indicating the detection of the desired sequence, and if the input is 1 the next state is state 1.

The Registered Moore State Machine block is configured with next state matrix and output array obtained from the next state/output table discussed above. They are constructed as shown below:

Figure 106: Next State Output Table

Next State/Output Table

Current State	If Input = 0	If Input = 1	Output
0	0	1	0
1	2	1	0
2	0	3	0
3	2	4	0
4	2	1	1

$$\begin{bmatrix} 0 & 1 \\ 2 & 1 \\ 0 & 3 \\ 2 & 4 \\ 2 & 1 \end{bmatrix}$$

Next State Matrix

$$\begin{bmatrix} 0 \\ 0 \\ 0 \\ 0 \\ 1 \end{bmatrix}$$

Output Matrix

X23251-092019

The rows of the matrices correspond to the current state. The next state matrix has one column for each input value. The output array has only one column since the input value does not affect the output of the state machine.

Block Parameters

The block parameters dialog box can be invoked by double-clicking the icon in your Simulink model.

The next state logic and state register in this block are implemented with high speed dedicated block RAM.

The number of bits used to implement a Moore state machine is given by the equations:

$$d_s = (2^k)(2^i) = 2^{k+i}$$

$$w_s = k$$

$$N_s = d_s * w_s = (k)(2^{k+i})$$

where

N_s = total number of next state logic block RAM bits

s = number of states

$$k = \text{ceil}(\log_2(s))$$

i = number of input bits

d_s = depth of state logic block RAM

w_s = width of state logic block RAM

The following table gives examples of block RAM sizes necessary for various state machines:

Table 27: State Machine block RAM Requirements

Number of States	Number of Input Bits	Block RAM Bits Needed
2	5	64
4	1	8
8	6	1536
16	5	2048
32	4	2560
52	1	768
100	4	14336

The block RAM width and depth limitations are described in the core datasheet for the Single Port Block Memory.

Virtex Line Buffer

The Xilinx Virtex Line Buffer reference block delays a sequential stream of pixels by the specified buffer depth.



Block Parameters

The block parameters dialog box can be invoked by double-clicking the icon in your Simulink model.

Parameters specific to this reference block are as follows:

- **Buffer Depth:** Number of samples the stream of pixels is delayed.

- **Sample Period:** Sample rate at which the block will run

Virtex2 Line Buffer

The Xilinx Virtex2 Line Buffer reference block delays a sequential stream of pixels by the specified buffer depth. It is optimized for the Virtex2 family since it uses the Read Before Write option on the underlying Single Port RAM block



Block Parameters

The block parameters dialog box can be invoked by double-clicking the icon in your Simulink model.

Parameters specific to this reference block are as follows:

- **Buffer Depth:** Number of samples the stream of pixels is delayed.
- **Sample Period:** Sample rate at which the block will run.

Virtex2 5 Line Buffer

The Xilinx Virtex2 5 Line Buffer reference block buffers a sequential stream of pixels to construct 5 lines of output. Each line is delayed by N samples, where N is the length of the line. Line 1 is delayed 4*N samples, each of the following lines are delay by N fewer samples, and line 5 is a copy of the input.

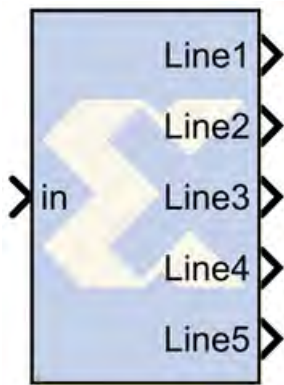

This block uses Virtex2 Line Buffer block which is located in the Imaging library of the Xilinx Reference Blockset.

Block Parameters

The block parameters dialog box can be invoked by double-clicking the icon in your Simulink model.

Parameters specific to this reference block are as follows:

- **Line Size:** Number of samples each line is delayed.
- **Sample Period:** Sample rate at which the block will run.

White Gaussian Noise Generator

The Xilinx® White Gaussian Noise Generator (WGNG) generates white Gaussian noise using a combination of the Box-Muller algorithm and the Central Limit Theorem following the general approach described in [1] (reference listed below).

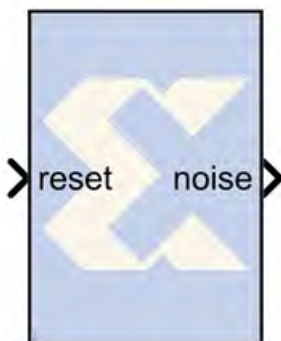

The Box-Muller algorithm generates a unit normal random variable using a transformation of two independent random variables that are uniformly distributed over [0,1]. This is accomplished by storing Box-Muller function values in ROMs and addressing them with uniform random variables.

The uniform random variables are produced by multiple-bit leap-forward LFSRs. A standard LFSR generates one output per clock cycle. K-bit leap-forward LFSRs are able to generate k outputs in a single cycle. For example, a 4-bit leap-forward LFSR outputs a discrete uniform random variable between 0 and 15. A portion of the 48-bit block parameter seed initializes each LFSR allowing customization. The outputs of four parallel Box-Muller Subsystems are averaged to obtain a probability density function (PDF) that is Gaussian to within 0.2% out to 4.8sigma. The overall latency of the WGNG is 10 clock cycles. The output port noise is a 12 bit signed number with 7 bits after the binary point.

4-bit Leap-Forward LFSR

Figure 107: 4-bit Leap-Forward LFSR Diagram

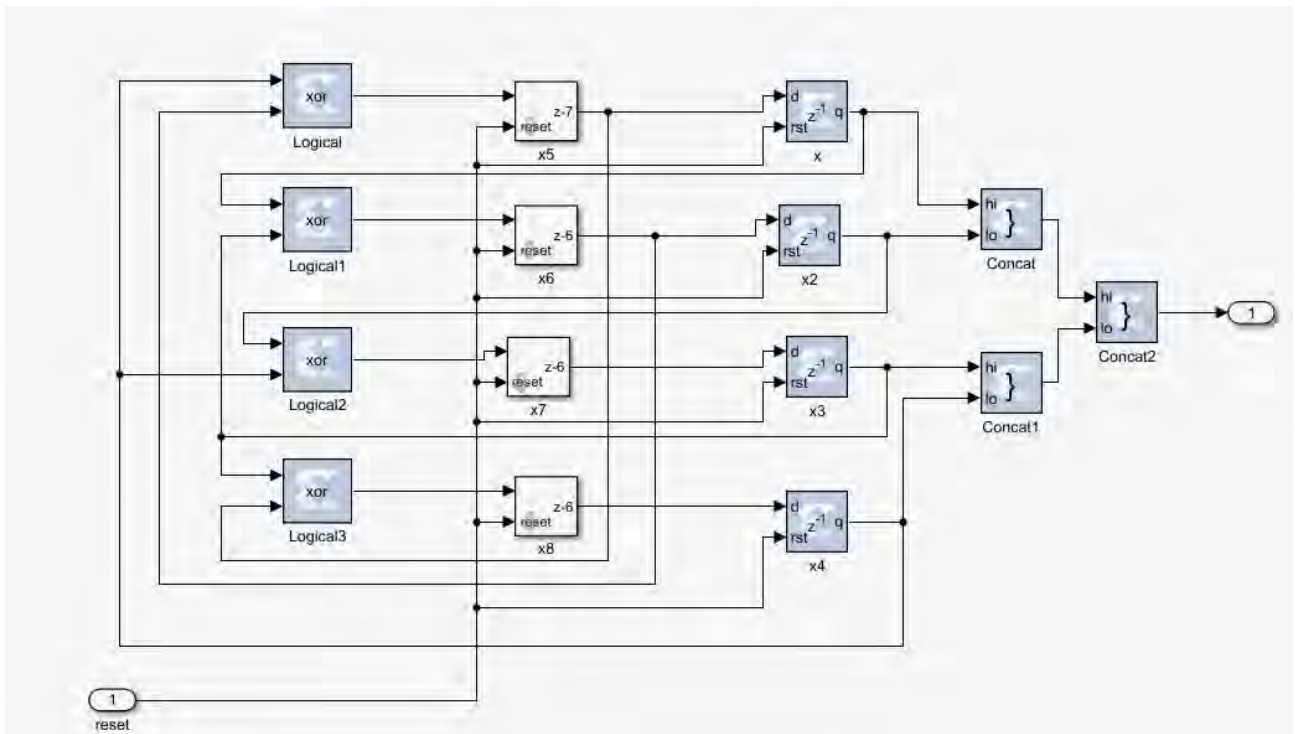

Box-Muller Method

Figure 108: **Box-Muller Method Diagram**

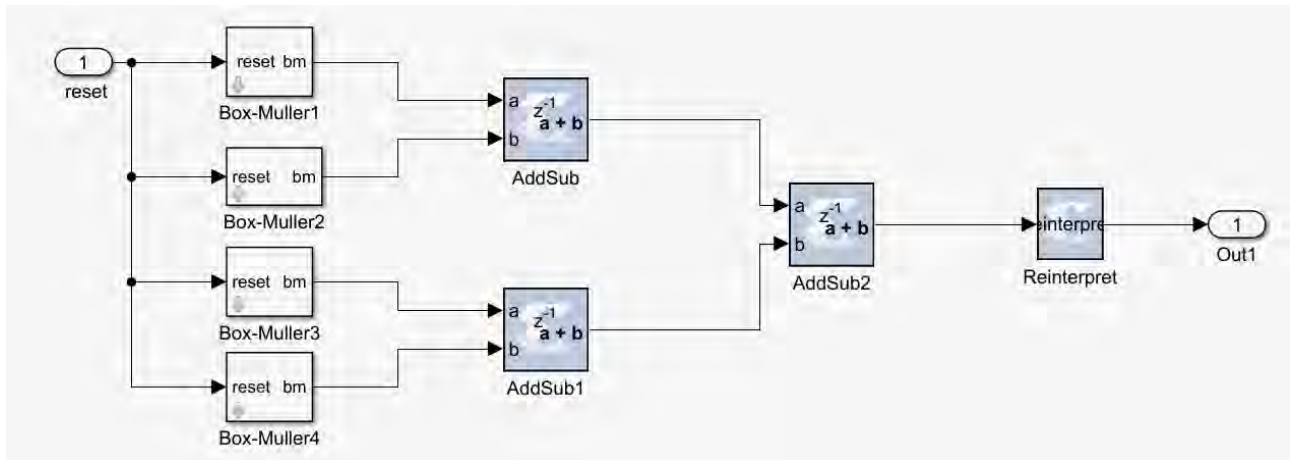

Block Parameters

The block parameters dialog box can be invoked by double-clicking the icon in your Simulink model.

The block parameter is a decimal starting seed value.

Reference

A. Ghazel, E. Boutillon, J. L. Danger, G. Gulak and H. Laamari, *Design and Performance Analysis of a High Speed AWGN Communication Channel Emulator*, IEEE PACRIM Conference, Victoria, B. C., Aug. 2001.

System Generator Utilities

xilinx.analyzer	Provides the interface between the System Generator model and Vivado® timing paths.
xilinx.environment.getcachepath and xilinx.environment.setcachepath	Used to get and set the path System Generator uses to store the simulation cache.
xilinx.resource_analyzer	Enables cross-probing between the System Generator model and Vivado resource utilization data.
xilinx.utilities.importBD	Imports a BD file created in the Vivado IP integrator and creates a stub for the System Generator model that is part of the design.
xlAddTerms	Automatically adds sinks and sources to System Generator models.
xlConfigureSolver	Configures the Simulink® solver settings of a model to provide optimal performance during System Generator simulation.
xlfda_denominator	Returns the denominator of the filter object in an FDATool block.
xlfda_numerator	Returns the numerator of the filter object in an FDATool block.
xlGenerateButton	Provides a programmatic way to invoke the System Generator code generator.
xlgetParam and xlsetparam	Used to get and set parameter values in a System Generator block.
xlgetparams	Used to get all parameter values in a System Generator block.
xlGetReOrderedCoeff	The xlGetReOrderedCoeff function provides the re-ordered coefficient set of a FIR Compiler block.
xlOpenWaveFormData	Allow you to populate saved simulation waveform data into running Waveform Viewer instance.
xlSetUseHDL	Sets the 'Use behavioral HDL' option of blocks in a model of a Subsystem.
xlTBUtills	Provides access to several useful procedures available to the Xilinx® Toolbar block, such as layout, redrawlines and getselected.

xilinx.analyzer

xilinx.analyzer is a MATLAB® class that provides an interface between the System Generator model and Vivado® timing paths.

The System Generator timing analysis is supported for all compilation targets. The **Perform analysis** drop down menu under the **Clocking** tab of the System Generator token provides two options for the trade-off between total runtime vs. accuracy of the Vivado timing data. If you select either the **Post Synthesis** or the **Post Implementation** option of **Perform analysis** and click the **Generate** button, then Vivado timing paths information is collected during the netlist generation. The `xilinx.analyzer` class is used to access Vivado timing paths information. The `xilinx.analyzer` class object processes Vivado timing paths to find 50 unique paths with the worst slack value. The unique timing paths are sorted in increasing value of slack and saved in the analyzer object.

The cross-probing between Vivado timing paths and the System Generator model is made possible using the following API functions in the `xilinx.analyzer` class.

Table 28: xilinx.analyzer Class Functions

Function Name	Description	Function Argument
<code>xilinx.analyzer</code>	This is a constructor of the class. A call to the <code>xilinx.analyzer</code> constructor returns object of the class.	First argument is System Generator model name. Second argument is path to already generated netlist directory.
<code>isValid</code>	Indicates if timing analysis data is valid or not. Use this API to make sure that the <code>xilinx.analyzer</code> class construction was successful.	No argument
<code>getErrorMessage</code>	Returns an error message string if the call to the class constructor or other API function had an error.	No argument
<code>getStatus</code>	Returns 'FAILED' if any of the timing paths in the model have a violation, i.e., negative slack.	No argument
<code>getVivadoStage</code>	Returns either Post Synthesis or Post Implementation. This is the Vivado design stage after which timing analysis was performed.	No argument
<code>paths</code>	Returns an array of MATLAB structures. Each structure contains data for a timing path.	A string that is equal to either 'setup' or 'hold'
<code>violations</code>	Returns an array of MATLAB structures. Each member of the array is a path structure with a timing violation.	A string that is equal to either 'setup' or 'hold'
<code>print</code>	Prints timing path information such as Slack, Path Delay, Levels of Logic, Name of Source and Destination blocks, and Source and Destination clocks.	An array of MATLAB structures for timing path data. The array can have one or more structures.
<code>highlight</code>	In the System Generator model, highlights blocks for the timing path passed in the argument. Blocks that are already highlighted in the model will remain highlighted.	MATLAB structure for one timing path
<code>highlightOnePath</code>	In the System Generator model, highlights blocks for the timing path passed in the argument. Before highlighting blocks for this path, the blocks that are already highlighted in the model will be unhighlighted.	MATLAB® structure for one timing path
<code>unhighlight</code>	In the Simulink® model, unhighlights all blocks currently highlighted.	No argument

Table 28: xilinx.analyzer Class Functions (cont'd)

Function Name	Description	Function Argument
<code>disp</code>	Displays a summary of timing analysis results on the MATLAB console, including the worst slack value among all timing paths.	No argument
<code>delete</code>	This is a destructor of the xilinx.analyzer class	No argument

Table 29: Timing Path Data in a MATLAB Structure

Field Name	Description
Slack	The double value containing timing slack for the path
Delay	Total Data Path delay for the path
Levels_of_Logic	Number of elements in Vivado design for the timing path. The number of System Generator blocks in the timing path may be different from Levels_of_Logic.
Source	First System Generator block in the timing path
Destination	Last System Generator block in the timing path
Source_Clock	Name of the clock domain for the source block
Destination_Clock	Name of the clock domain for the destination block
Path_Constraints	Timing constraint used for the path. For a multi-clock design, the path constraint can be a multi-clock timing constraint.
Block_Masks	Cell array where each element contains mask information for a System Generator block.
Simulink_Names	Cell array where each element contains hierarchical name of a block in System Generator model
Vivado_Names	Cell array where each element contains name of System Generator block in Vivado database
Type	A timing violation type. The value is either 'setup' or 'hold'.

xilinx.analyzer - Construct xilinx.analyzer class object

Syntax

```
analyzer_object = xilinx.analyzer(<name_of_the_model>',
    '<path_to_netlist_directory>')
```

- **Description:**

A call to xilinx.analyzer constructor returns object of the class.

The first argument is the name of the System Generator model. The model must be open before the class constructor is called.

The second argument is an absolute or relative path to the netlist directory. You must have read permission to the netlist directory.

To access API functions of the `xilinx.analyzer` class use the object of the class as described below. To get more details for a specific API function type the following at the MATLAB command prompt:

```
help xilinx.analyzer.<API_function>
```

- **Example:**

```
//Construct class. Must give the model name and absolute or relative path
to the
//target directory

>> timing_object = xilinx.analyzer('fixed_point_IIR', './
netlist_for_timing_analysis')

timing_object =

Number of setup paths = 9
Worst case setup slack = -1.6430
```

isValid – Check validity of Vivado timing paths

- **Syntax:**

```
result = analyzer_object.isValid();
```

- **Description:**

If timing analysis data is valid then the result equals '1', otherwise it is '0'. Use this API to make sure that the `xilinx.analyzer` class construction was successful and the timing data was valid.

- **Example:**

```
//Determine if timing analysis data is valid

>> valid_status = timing_object.isValid()

valid_status =

    1
```

getErrorMessage - Get an error message

- **Syntax:**

```
result = analyzer_object.getErrorMessage();
```

- **Description:**

Returns an error message string if the call to the class constructor or other API function had an error.

- **Example:**

```
//Determine if there was an error in the xilinx.analyzer constructor
//or in any of the API functions

>> err_msg = timing_object.getErrorMessage()

err_msg =
    ''
```

getStatus - Timing analysis status

- **Syntax:**

```
string = analyzer_object.getStatus();
```

- **Description:**

The returned string is either 'PASSED' or 'FAILED'. If any of the timing paths have a violation, i.e. negative slack, then the timing analysis status is considered failed.

- **Example:**

```
//Determine if there were timing path violations in Simulink model

>> analysis_status = timing_object.getStatus()

analysis_status =
    FAILED
```

getVivadoStage - Get Vivado design stage for timing analysis

- **Syntax:**

```
string = analyzer_object.getVivadoStage();
```

- **Description:**

The returned string is the Vivado design stage after which timing analysis was performed and data collected in Vivado. The value is either 'Post Synthesis' or 'Post Implementation'.

- **Example:**

```
//Determine Vivado stage when timing data was collected
>> design_stage = timing_object.getVivadoStage()
design_stage =
Post Synthesis
```

paths - Access all timing paths

- **Syntax:**

```
<array_of_timing_paths_structure> =
analyzer_object.paths('<violation_type>');
```

- **Description:**

The returned value is an array of MATLAB structures. Each structure contains data for a timing path, sorted in decreasing order of timing violation, i.e. in increasing order of slack value.

The argument 'violation_type' is either 'setup' or 'hold' string.

- **Example:**

```
//Return an array of the timing path structures
>> all_timing_paths = timing_object.paths('setup')
all_timing_paths =
1x9 struct array with fields:
    Slack
    Delay
    Levels_of_Logic
    Source
    Destination
    Source_Clock
    Destination_Clock
    Path_Constraints
    Block_Masks
    Simulink_Names
    Vivado_Names
    Type
```

Note:

There are a total of nine timing paths in this timing analysis.

You can find the data fields in each timing path as shown in Example 1 in [Additional Information](#).

violations - Access paths with timing violations

- **Syntax:**

```
<array_of_timing_paths_structure> =
analyzer_object.violations('<violation_type>');
```

- **Description:**

The returned value is an array of MATLAB structures. Each member of the array is data for a path with a timing violation. The array elements are sorted in decreasing order of timing violation. If there are no timing violations in the design then the API function returns an empty array.

The argument 'violation_type' is either 'setup' or 'hold'.

- **Example:**

```
//Return an array of timing paths with setup violations
>> violating_paths = timing_object.violations('setup')
violating_paths =
1x2 struct array with fields:
    Slack
    Delay
    Levels_of_Logic
    Source
    Destination
    Source_Clock
    Destination_Clock
    Path_Constraints
    Block_Masks
    Simulink_Names
    Vivado_Names
    Type
```

There are a total of two paths with violations in this timing analysis.

You can find the data fields in each timing path as shown in Example 3 in [Additional Information](#).

print - Print timing path information

- **Syntax:**

```
analyzer_object.print(<timing_path_structures>);
```

- **Description:**

Prints timing data such as Slack, Path Delay, Levels of Logic, Name of Source and Destination blocks, Source and Destination clocks, Path Constraints, etc. for the input timing path structure.

The argument is an array of MATLAB structures with one or more elements.

- **Examples:**

```
//Print timing path information for path #1
>> timing_object.print(all_timing_paths(1))
Path Num          Slack (ns)          Delay (ns)          Levels
of Logic
Source/Destination Blocks          Source Clock      Destination
Clock            Path
Constraints
1
11.5690          6          -1.6430
fixed_point_IIR/Delay1
clk
create_clock -name clk -period 2 [get_ports clk]

fixed_point_IIR/IIR Filter Subsystem/Delay4
ans =
    1

//Print timing path information for path #3
>> timing_object.print(all_timing_paths(3))
Path Num          Slack (ns)          Delay (ns)          Levels
of Logic
Source/Destination Blocks          Source Clock      Destination
Clock            Path
Constraints
1
0.5270          0          1.1320
fixed_point_IIR/Delay1
clk
create_clock -name clk -period 2 [get_ports clk]

fixed_point_IIR/Delay1
ans =
    1
```

```
//Print timing path information for path #2 from violating_paths array
>> timing_obj.print(violating_paths(2))
Path Num          Slack (ns)          Delay (ns)          Levels
of Logic
Source/Destination Blocks          Source Clock      Destination
Clock          Path
Constraints
    1          -1.3260
11.2520          6
fixed_point_IIR/Delay1
clk          clk
create_clock -name clk -period 2 [get_ports clk]

fixed_point_IIR/Delay2

ans =

    1
```

highlight - Highlight design blocks for a timing path

- **Syntax:**

```
analyzer_object.highlight(<timing_path_structure>);
```

- **Description:**

This API highlights System Generator blocks for the timing path passed in the argument. It doesn't change the highlighting of a block from other paths, so more than one timing path can be highlighted if you use this function repeatedly.

The argument is the MATLAB structure for one timing path.

- **Example:**

```
//Highlight Simulink model blocks in the selected path
//Don't change highlighting of currently highlighted blocks in the model
>> [result, err_msg] = timing_object.highlight(all_timing_paths(1));
```

Highlighted System Generator model blocks appear as shown below.

Figure 110: System Generator Model Blocks

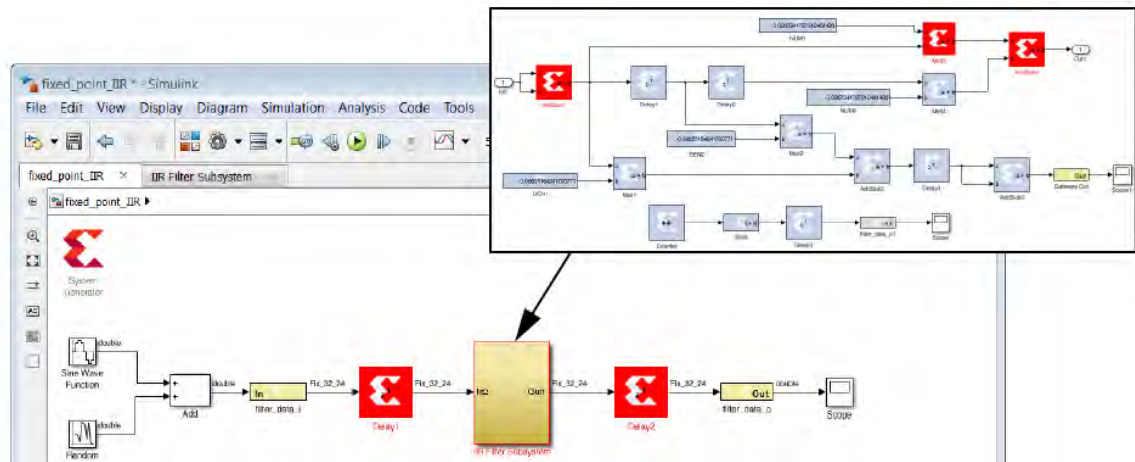

highlightOnePath - Highlight design blocks for one timing path

- **Syntax:**

```
analyzer_object.highlightOnePath(<timing_path_structure>);
```

- **Description:**

This API highlights System Generator blocks for the timing path passed in the argument. If a block from other paths is already highlighted then it will be unhighlighted first, so only one path is highlighted at a time.

The argument is the MATLAB structure for one timing path.

- **Example:**

```
//Highlight a single path in System Generator model, and unhighlight
currently
//highlighted paths
>> [result, err_msg] = timing_object.highlightOnePath(violating_paths(2));
```

unhighlight - Unhighlight design blocks

- **Syntax:**

```
analyzer_object.unhighlight();
```

- **Description:**

This API unhighlights blocks that are already highlighted. The blocks in System Generator model are displayed in their original colors.

- **Example:**

```
//Unhighlight any Simulink block that is currently highlighted
>> [result, err_msg] = timing_object.unhighlight();
```

disp - Display summary of timing analysis

- **Syntax:**

```
analyzer_object.disp();
```

- **Description:**

This API displays the summary of timing paths on the MATLAB console, including the worst slack value.

- **Example:**

```
//Display a summary of timing analysis
>> timing_object.disp()
Number of setup paths = 9
Worst case setup slack = -1.6430
```

delete - Delete xilinx.analyzer class object

- **Syntax:**

```
analyzer_object.delete();
```

- **Description:**

This is a destructor for the xilinx.analyzer class.

- **Example:**

```
//Delete xilinx.analyzer object, i.e., timing_object
>> timing_object.delete();
```

Additional Information

Accessing data fields of timing path structures:

- **Example 1: Data for timing path #1:**

```
//Return the data fields for the timing path with the worst slack
>> all_timing_paths(1)

ans =

           Slack: -1.6430
           Delay: 11.5690
    Levels_of_Logic: 6
           Source: 'fixed_point_IIR/Delay1'
           Destination: 'fixed_point_IIR/IIR Filter Subsystem/Delay4'
           Source_Clock: 'clk'
           Destination_Clock: 'clk'
    Path_Constraints: 'create_clock -name clk -period 2 [get_ports ...]'
           Block_Masks: {1x5 cell}
           Simulink_Names: {1x5 cell}
           Vivado_Names: {1x5 cell}
           Type: 'setup'
```

- **Example 2: Data for timing path #3:**

```
//Return the data fields for a timing path
>> all_timing_paths(3)

ans =

           Slack: 1.1320
           Delay: 0.5270
    Levels_of_Logic: 0
           Source: 'fixed_point_IIR/Delay1'
           Destination: 'fixed_point_IIR/Delay1'
           Source_Clock: 'clk'
           Destination_Clock: 'clk'
    Path_Constraints: 'create_clock -name clk -period 2 [get_ports ...]'
           Block_Masks: {'fprintf('','COMMENT: begin icon graphics')...'}
           Simulink_Names: {'fixed_point_IIR/Delay1'}
           Vivado_Names: {'fixed_point_iir.fixed_point_iir_struct.delay1'}
```

Type: 'setup'

- **Example 3: Data for path #1 in violating_paths array:**

```
//Return the data fields in a timing path with timing violations
>> violating_paths(1)

ans =

           Slack: -1.6430
```

```
        Delay: 11.5690
Levels_of_Logic: 6
        Source: 'fixed_point_IIR/Delay1'
        Destination: 'fixed_point_IIR/IIR Filter Subsystem/Delay4'
        Source_Clock: 'clk'
Destination_Clock: 'clk'
Path_Constraints: 'create_clock -name clk -period 2 [get_ports ...]'
        Block_Masks: {1x5 cell}
        Simulink_Names: {1x5 cell}
        Vivado_Names: {1x5 cell}
        Type: 'setup'
```

xilinx.environment.getcachepath and xilinx.environment.setcachepath

`xilinx.environment.getcachepath` is used to get the path System Generator currently uses to store the simulation cache.

`xilinx.environment.setcachepath` is used to change the path System Generator uses to store the simulation cache.

Syntax

```
xilinx.environment.getcachepath
xilinx.environment.setcachepath(path)
```

Description

When you simulate a Simulink model containing Xilinx IP in System Generator, the Vivado simulator simulation data for that particular IP configuration is cached to speed up the simulation.

System Generator establishes the simulation cache at a default location at startup, and you can determine the current path to the simulation cache with the `xilinx.environment.getcachepath` command. If you need to change the location of the simulation cache, use the `xilinx.environment.setcachepath` command. You will need to have write permission on the destination path directory. The new path will apply for the remainder of your System Generator session.

One reason you would use `xilinx.environment.setcachepath` is to set the path if you do not have write permission on the default directory System Generator uses for caching simulation data.

Examples

Example 1: Getting the current simulation cache path.

```
>> xilinx.environment.getcachepath  
  
ans =  
  
C:\Users\my_login\AppData\Local\Xilinx\Sysgen\SysgenVivado\win64.o
```

Example 2: Setting a new simulation cache path.

```
>> xilinx.environment.setcachepath('C:\sim_cache')  
  
ans =  
  
C:\sim_cache  
  
>> xilinx.environment.getcachepath  
  
ans =  
  
C:\sim_cache
```

xilinx.resource_analyzer

`xilinx.resource_analyzer` is a MATLAB class that enables cross-probing between the System Generator model and Vivado resource utilization data.

The System Generator resource analysis is supported for all compilation targets. The **Perform analysis** drop down menu under the **Clocking** tab of the System Generator token provides two options for the trade-off between Vivado tools runtime vs. accuracy of the resource utilization data. If you select either the **Post Synthesis** or the **Post Implementation** option of **Perform analysis** and click the **Generate** button, then Vivado resource utilization information is collected during the netlist generation. Once the netlist generation has completed, the `xilinx.resource_analyzer` class is used to access this Vivado resource utilization results. The `xilinx.resource_analyzer` class object processes Vivado resource utilization data to display the number of resources (BRAMs, DSPs, Registers, and LUTs) used in the Simulink model, as well as by the subsystems and low-level blocks in the model.

The cross-probing between Vivado resource utilization results and the System Generator model is made possible through the following API functions in the `xilinx.resource_analyzer` class.

Table 30: Functions in xilinx.resource_analyzer Class

Function Name	Description	Function Argument
xilinx.resource_analyzer	This is a constructor of the class. A call to the <code>xilinx.resource_analyzer</code> constructor returns object of the class.	First argument is design model name. Second argument is path to already generated netlist directory.
getVivadoStage	Returns either <code>Post Synthesis</code> or <code>Post Implementation</code> . This is the Vivado design stage after which resource analysis was performed.	No argument
getDevicePart	Returns a string for device part, package and speed grade for the device in which the design will be implemented.	No argument
getDeviceResource	Returns a string for the total count of the specified type of resource in the target Xilinx device.	(Optional) Resource type. Resource types are: BRAMs, DSPs, Registers, or LUTs.
printDeviceResources	Prints the total number of BRAMs, DSPs, Registers, and LUTs available on the target Xilinx device. The counts are printed in the MATLAB console.	No argument.
getCount	Returns a count for the particular resource type used by a block or subsystem.	(Optional) First argument is a Simulink handle or pathname for the block. (Optional) Second argument is Resource type. Resource types are: BRAMs, DSPs, Registers, or LUTs.
print	Returns a count for the particular resource type used by a block or subsystem.	(Optional) First argument is a Simulink handle or pathname for the block or subsystem. (Optional) Second argument is resource type. Resource types are: BRAMs, DSPs, Registers, or LUTs.
getDistribution	Returns three values: An array of MATLAB structures. Each element in the array is a structure containing the name of a block or subsystem directly under the subsystem in the argument, with a key-value pair of the resource type and number of resources used by that sub block or subsystem. A count of the resources used by the self (the block or subsystem specified in the argument). A count of the resources used by both blocks and subsystems combined.	First argument is a Simulink handle or pathname for the block or subsystem. Second argument is resource type. Resource types are: BRAMs, DSPs, Registers, or LUTs.
getErrorMessage	Returns an error message string if the call to the class constructor or other API function had an error.	No argument
highlight	In the Simulink model, highlights the specified block or subsystem with yellow color and red border.	A Simulink handle or pathname for the block to highlight.
unhighlight	In the Simulink model, unhighlights a block which is currently highlighted.	(Optional) A Simulink handle or pathname for the block to unhighlight.
delete	This is a destructor of the <code>xilinx.resource_analyzer</code> class	No argument

Table 31: Resource Data in a MATLAB Structure

Field Name	Description
BRAMs	Count of block RAM resources for a block or subsystem. BRAMs are counted in this way: <ul style="list-style-type: none"> • RAMB36E: 1 BRAM • RAMB36E: 1 BRAM • RAMB18E: 0.5 BRAM • FIFO18E: 0.5 BRAM Variations of Primitives (for example, RAM36E1 and RAM36E2) are all counted in the same way. Total BRAMs = (Number of RAMB36E) + (Number of FIFO36E) + 0.5 (Number of RAMB18E + Number of FIFO18E)
DSPs	Count of DSP48 resources utilized by a block or subsystem.
Registers	Count of Flip-Flops and Latches used by the design is reported as the number of Registers utilized by the design model, a particular block, or a subsystem.
LUTs	Count of all LUT type resources utilized by a block or subsystem.

xilinx.resource_analyzer – Construct xilinx.resource_analyzer class object

Syntax

```
resource_analyzer_obj =
xilinx.resource_analyzer('<name_of_the_model>', '<path_to_netlist_directory>')
;
```

Description

A call to `xilinx.resource_analyzer` constructor returns object of the class.

The first argument is the name of the System Generator model. The model must be open before the class constructor is called.

The second argument is an absolute or relative path to the netlist directory. You must have read permission to the netlist directory.

To access API functions of the `xilinx.resource_analyzer` class use the object of the class as described below. To get more details for a specific API function type the following at the MATLAB command prompt:

```
help xilinx.resource_analyzer.<API_function>
```

Example

```
//Construct class. Must give the model name and absolute or relative path
to the
//target directory

>> res_obj = xilinx.resource_analyzer('test_decimator', './
netlist_for_resource_analysis')

res_obj =

Resources used by: test_decimator
BRAMs => 0.5
DSPs => 1
Registers => 273
LUTs => 153
```

getVivadoStage – Get Vivado design stage for resource analysis

Syntax

```
string = resource_analyzer_obj.getVivadoStage();
```

Description

The returned string is the Vivado design stage after which resource analysis was performed and data collected in Vivado. The value is either `Post Synthesis` or `Post Implementation`.

Example

```
//Determine Vivado stage when resource data was collected

>> design_stage = res_obj.getVivadoStage()

design_stage =

Post Synthesis
```

getDevicePart – Get target Xilinx device part name

Syntax

```
string = resource_analyzer_obj.getDevicePart();
```

Description

Gets the name of the Xilinx device to which your design is targeted.

Example

```
//Get the Xilinx part in which you will implement your design
>> part_name = res_obj.getDevicePart()
part_name =
xc7k325tfbg676-3
```

getDeviceResource - Get number of resources in target device

Syntax

```
total_resource_count =
resource_analyzer_obj.getDeviceResource(<resource_type>);
```

Description

The returned value is the total number of a particular type of resource contained in the Xilinx device for which you are targeting your design.

The `resource_type` may be:

- BRAMs - Block RAM and FIFO primitives
- DSPs - DSP48 primitives
- Registers - Registers and Flip-Flops
- LUTs - All LUT types combined

If no `resource_type` is provided, the command returns a MATLAB structure containing all device resources.

Example

```
//Determine the total number of Block RAMs in the Xilinx device
>> total_brams = res_obj.getDeviceResource('BRAMs')
total_brams =
445

//Determine the total number of Block RAMs, DSP blocks, Registers, and LUTs
in the
//Xilinx device
>> total_resource_count = res_obj.getDeviceResource
total_resource_count =
```

```

BRAMs: '445'
DSPs: '840'
Registers: '407600'
LUTs: '203800'
    
```

printDeviceResources - Print number of resources in target device

Syntax

```
resource_analyzer_obj.printDeviceResources();
```

Description

Prints the number of all types of resources in the used Xilinx device. The output is printed in the MATLAB console.

Examples

```

//Print the number of all types of resources contained in the target Xilinx
device

>> res_obj.printDeviceResources()

BRAMs => 445
DSPs => 840
Registers => 407600
LUTs => 203800
    
```

getCount - Get resource utilization for subsystem or block

Syntax

```
<block_resource_count> =
resource_analyzer_obj.getCount(<blockID>,<resource_type>);
```

Description

The returned value is the total number of a particular type of resource used in the specified subsystem or block.

The `blockID` can be either a Simulink handle or a pathname (a hierarchical name) for the subsystem or block.

The `resource_type` may be:

- BRAMs - Block RAM and FIFO primitives
- DSPs - DSP48 primitives
- Registers - Registers and Flip-Flops

- LUTs - All LUT types combined

If no `resource_type` is provided, the command returns a MATLAB structure containing all device resources.

Example

```
// Return register resource utilization for Simulink block with pathname
// test_decimator/addr_gen

>> regs_in_block = res_obj.getCount('test_decimator/addr_gen', 'Registers')

ans =

    105
//Return resource utilization for the entire Simulink model

>> total_resource_count = res_obj.getCount()

Resources used by: test_decimator
BRAMs => 0.5
DSPs => 1
Registers => 273
LUTs => 153
```

print – Prints all resources used by a subsystem or block

Syntax

```
resource_analyzer_obj.print(<blockID>);
```

Description

Prints all resources (for all resource types: BRAMs, Registers, DSPs, and LUTs) used by a subsystem or block, in key-value pair. Resources are printed in the MATLAB console.

If you enter a `blockID` (which can be either a Simulink handle or a pathname), all resources used by the specified block or subsystem will be printed in the MATLAB console.

If no `blockID` argument is provided, all resources used by the top-level design will be printed in the MATLAB console.

Example

```
// Print resource utilization for Simulink subsystem with pathname
// test_decimator/addr_gen

>> res_obj.print('test_decimator/subsystem1')
Resources used by: test_decimator/subsystem1
BRAMs => 0.5
DSPs => 1
```

```

Registers => 49
LUTs => 97

//Print resource utilization for the entire Simulink model

>> res_obj.print()
Resources used by: test_decimator
BRAMs => 0.5
DSPs => 1
Registers => 273
LUTs => 153
    
```

getDistribution - Get count of each resource type used by each block and subsystem under a specified subsystem

Syntax

```

[<distribution_array>, <self_count>, <total_count>] =
resource_analyzer_obj.getDistribution(<blockId>, <resource_type>)
    
```

Description

Returns count for the specified type of resource used by each block and subsystem directly under the subsystem passed as the argument.

The three returned values are:

- An array of MATLAB structures. Each element in the array is a structure containing the name of a block or subsystem directly under the subsystem in the argument, with a key-value pair of the resource type and number of resources used by that sub block or subsystem.
- A count of the resources used by the self (the block or subsystem specified in the argument).
- A count of the resources used by both blocks and subsystems combined.

The `blockID` can be either a Simulink handle or a pathname (a hierarchical name) for the subsystem or block. If no `blockID` is provided, then the command assumes the top-level module.

The `resource_type` may be:

- BRAMs - Block RAM and FIFO primitives
- DSPs - DSP48 primitives
- Registers - Registers and Flip-Flops
- LUTs - All LUT types combined

Example

```
// Return Register resource distribution for Simulink block with pathname
// test_decimator. This is top level of the design

>> [res_dist, self, total] = res_obj.getDistribution
('test_decimator','Registers')

res_dist =

1x8 struct array with fields:

    Name
    Hier_Name
    Count

self =

    119

total =

    273
//Return resource utilization for the entire Simulink model

>> total_resource_count = res_obj.getCount()

Resources used by: test_decimator
BRAMs => 0.5
DSPs => 1
Registers => 273
LUTs => 153
```

getErrorMessage – Get an error message

Syntax

```
result = resource_analyzer_obj.getErrorMessage();
```

Description

Returns an error message string if the call to the class constructor or other API function had an error.

Example

```
//Determine if there was an error in the xilinx.resource_analyzer
constructor
//or in any of the API functions
```

```
>> err_msg = res_obj.getErrorMessage()

err_msg =
    ''
```

highlight – Highlight design subsystems and blocks

Syntax

```
resource_analyzer_obj.highlight(<blockId>)
```

Description

This API highlights blocks in the Simulink model. Highlighted blocks in the System Generator model are displayed in yellow and outlined in red. Highlighting blocks using this command does not change the highlighting of other blocks currently highlighted, so more than one block can be highlighted if you use this function repeatedly.

When you enter a `blockID` (which can be either a Simulink handle or a pathname) for a block or subsystem, the specified block or subsystem will be highlighted in the Simulink model. When the block/subsystem is highlighted then all parent subsystems up to the top level are also highlighted. When the top level module handle is provided as the `highlight` function argument no block is highlighted, but the Simulink model display changes to the top level, showing all blocks and subsystems at the top level.

Example

```
//Highlight Simulink block with pathname fixed_point_IIR/IIR Filter
Subsystem/Mult1

>> res_obj.highlight('test_decimator/addr_gen/AddSub1')
```

Highlighted System Generator model blocks appear as shown below.

Figure 142: System Generator Model Blocks

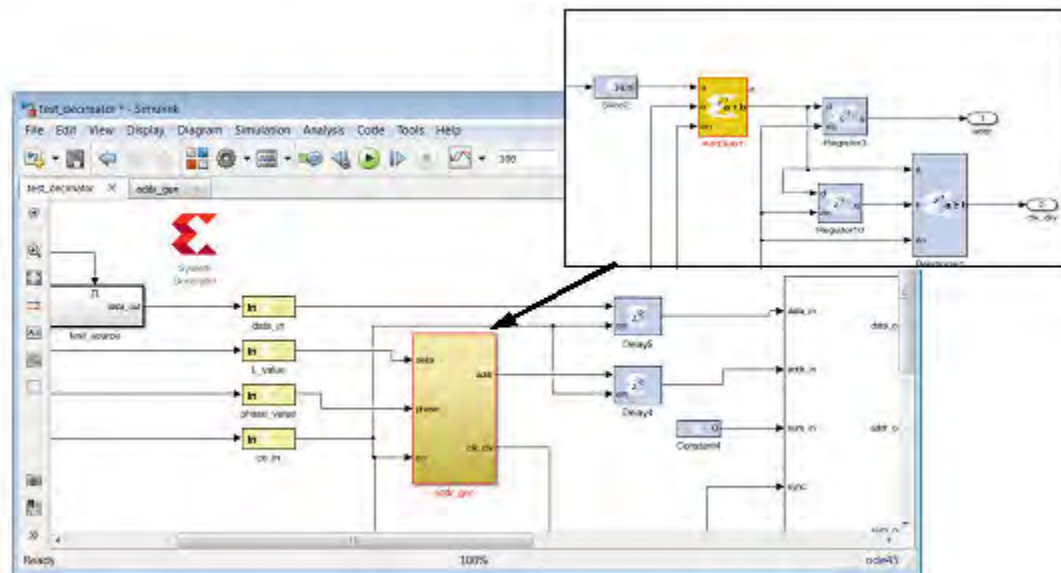

unhighlight - Unhighlight design subsystems and blocks

Syntax

```
resource_analyzer_obj.unhighlight(<blockId>)
```

Description

This API unhighlights blocks that are currently highlighted in the Simulink model. When they are unhighlighted, the blocks in the System Generator model are displayed in their original colors.

If you enter a `blockID` (which can be either a Simulink handle or a pathname) for a block or subsystem, the specified block or subsystem will be unhighlighted in the Simulink model. When the block/subsystem is unhighlighted, all parent subsystems up to the top level are also unhighlighted.

If no `blockID` argument is provided, all currently highlighted blocks and subsystems will be unhighlighted.

Example

```
//Unhighlight Simulink block with pathname test_decimator/addr_gen/Register4
>> res_obj.unhighlight('test_decimator/addr_gen/Register4')

//Unhighlight all Simulink blocks that are currently highlighted
>> res_obj.unhighlight();
```

delete – Delete xilinx.resource_analyzer class object

Syntax

```
resource_analyzer_obj.delete();
```

Description

This is a destructor for the `xilinx.resource_analyzer` class.

Example

```
//Delete xilinx.resource_analyzer object, i.e., res_obj
>> delete(res_obj);
```

OR

```
>> res_obj.delete();
```

xilinx.utilities.importBD

`xilinx.utilities.importBD` imports a platform framework created in the Vivado IP Integrator into a System Generator model. The command provides an accelerated way to enter the System Generator circuitry into the design. `xilinx.utilities.importBD` parses the platform framework for potential System Generator ports and interfaces and creates a sample stub in the Simulink model.

Inputs to the `xilinx.utilities.importBD` command are the Vivado project to be imported and the name of the model to be created in System Generator.

Syntax

```
xilinx.utilities.importBD(vivado_project,matlab_file)
```

Description

`xilinx.utilities.importBD` parses the platform framework Vivado project for potential System Generator ports and interfaces and creates a sample stub to speed the development of the System Generator model.

```
xilinx.utilities.importBD('<path_to_vivado_project_directory>/
<project_name>.xpr',
'mynewmodel')

xilinx.utilities.importBD('C:\test_impportBD\platform.xpr', 'mynewmodel')
```

xlAddTerms

`xlAddTerms` is similar to the `addterms` command in Simulink, in that it adds blocks to terminate or drive unconnected ports in a model. With `xlAddTerms`, output ports are terminated with a Simulink terminator block, and input ports are correctly driven with either a Simulink or System Generator constant block. Additionally System Generator gateway blocks can also be conditionally added.

The `optionStruct` argument can be configured to instruct `xlAddTerms` to set a block's property (e.g. set a constant block's value to 5) or to use different source or terminator blocks.

Syntax

```
xlAddTerms(arg1,optionStruct)
```

Description

In the following description, 'source block' refers to the block that is used to drive an unconnected port. And 'term block' refers to the block that is used to terminate an unconnected port.

```
xlAddTerms(arg1,optionStruct)
```

`xlAddTerms` takes either 1 or 2 arguments. The second argument, `optionStruct` argument is optional. The first argument can be the name of a system, or a block list.

Table 32: xlAddTerms Arguments

arg1	Description
gcs	A string-handle of the current system

Table 32: xAddTerms Arguments (cont'd)

arg1	Description
'top/test1'	A string-handle of a system called test1. In this case, xAddTerms is passed a handle to a system. This will run xAddTerms on all the blocks under test1, including all children blocks of Subsystems.
{'t/b1';'t/b2';'t/b3'}	A block list of string handles. In this case, xAddTerms is passed a handle to a block. This will run xAddTerms only on the block called test1, and will not process child blocks.
{'t/b1';'t/b2';'t/b3'}	A block list of string handles.
[1;2;3]	A block list of numeric handles.

The optionStruct argument is optional, but when included, should be a MATLAB structure. The following table describes the possible values in the structure. The structure field names (as is true with all MATLAB structure field names) are case sensitive.

Table 33: optionStruct Arguments

optionStruct	Description
Source	<p>xAddTerms can terminate in-ports using any source block (refer to SourceWith field). The parameters of the source block can be specified using the Source field of the optionStruct by passing the parameters as sub-fields of the Source field. The Source field prompts xAddTerms to do a series of set_params on the source block. Since it is possible to change the type of the source block, it is left to the user to ensure that the parameters here are relevant to the source block in use. E.g. when a Simulink constant block is used as a Source Block, setting the block's value to 10 can be done with:</p> <pre>Source.value = '10'</pre> <p>And when a System Generator Constant block is used as a Source Block, setting the constant block to have a value of 10 and of type UFIX_32_0 can be done with:</p> <pre>Source.const = '10'; Source.arith_type='Unsigned'; Source.bin_pt=0; Source.n_bits=32;</pre>
SourceWith	<p>The SourceWith field allows the source block to be specified. Default is to use a constant block. SourceWith has two sub-fields which must be specified.</p> <p>SourceWithBlock: A string specifying the full path and name of the block to be used. e.g. 'built-in/Constant' or 'xbsIndex_r3/AddSub'.</p> <p>SourceWithPort: A string specifying the port number used to connect. E.g. '1' or '3' Specifying '1' instructs xAddTerms to connect using port 1, etc.</p>

Table 33: optionStruct Arguments (cont'd)

optionStruct	Description
TermWith	<p>The TermWith Field allows the term block to be specified. Default is to use a Simulink terminator block. TermWith has two sub-fields which must be specified.</p> <p>TermWithBlock: A string specifying the full path and name of the block to be used. e.g. 'built-in/Terminator' or 'xbsIndex_r3/AddSub'.</p> <p>TermWithPort:</p> <p>A string specifying the port number used to connect. E.g. '1' or '3'</p> <p>Specifying '1' instructs xlAddTerms to connect using port 1, etc.</p>
UseGatewayIns	<p>Instructs xlAddTerms to insert System Generator gateway ins when required. The existence of the field is used to denote insertion of gateway ins. This field must not be present if gateway ins are not to be used.</p>
GatewayIn	<p>If gateway ins are inserted, their parameters can be set using this field, in a similar way as for Source and Term.</p> <p>For example,</p> <pre>GatewayIn.arith_type='Unsigned'; GatewayIn.n_bits='32' GatewayIn.bin_pt='0'</pre> <p>will set the gateway in to output a ufix_32_0.</p>
UseGatewayOuts	<p>Instructs xlAddTerms to insert System Generator gateway outs when required. The existence of the field is used to denote insertion of gateway outs. This field must not be present if gateway outs are not to be used.</p>
GatewayOut	<p>If gateway outs are inserted, their parameters can be set using this field, in a similar way as for Source and Term.</p> <p>For example,</p> <pre>GatewayOut.arith_type='Unsigned'; GatewayOut.n_bits='32' Gatewayout.bin_pt='0'</pre> <p>will set the gateway out to take an input of ufix_32_0.</p>
RecurseSubsystems	<p>Instructs xlAddTerm to recursively run xlAddTerm under all child Subsystems. Expects a scalar number, 1 or 0.</p>

Examples

Example 1: Runs xlAddTerms on the current system, with the default parameters: constant source blocks are used, and gateways are not added. Subsystems are recursively terminated.

```
xlAddTerms(gcs);
```

Example 2: runs xlAddTerms on all the blocks in the Subsystem tt./mySubsystem.

```
xlAddTerms(find_system('tt/mySubsystem','SearchDepth',1));
```

Example 3: runs `xlAddTerms` on the current system, setting the source block's constant value to 1, using gateway outs and changing the term block to use a Simulink display block.

```
s.Source.const = '10';  
s.UseGatewayOuts = 1;  
s.TermWith.Block = 'built-in/Display';  
s.TermWith.Port = '1';  
s.RecurseSubsystem = 1;  
xlAddTerms(gcs,s);
```

Remarks

Note that field names are case sensitive. When using the fields 'Source', 'GatewayIn' and 'GatewayOut', users have to ensure that the parameter names to be set are valid.

See Also

[Toolbar](#), [xlTBUtils](#)

xlConfigureSolver

The `xlConfigureSolver` function configures the Simulink solver settings of a model to provide optimal performance during System Generator simulation.

Syntax

```
xlConfigureSolver(<model_handle>);
```

Description

The `xlConfigureSolver` function configures the model referred to by `<model_handle>`. `<model_handle>` can be a string or numeric handle to a Simulink model. Library models are not supported by this function since they have no simulation solver parameters to configure.

For optimal performance during System Generator simulation, the following Simulink simulation configuration parameters are set:

```
'SolverType' = 'Variable-step'  
'Solver' = 'VariableStepDiscrete'  
'SolverMode' = 'SingleTasking'
```

xlfd_a_denominator

The `xlfd_a_denominator` function returns the denominator of the filter object stored in the Xilinx FDATool block.

Syntax

```
[den] = xlfd_a_denominator(FDATool_name);
```

Description

Returns the denominator of the filter object stored in the Xilinx FDATool block named `FDATool_name`, or throws an error if the named block does not exist. The block name can be local (e.g. 'FDATool'), relative (e.g. '../FDATool'), or absolute (e.g. 'untitled/foo/bar/FDATool').

See Also

[xlfd_a_numerator](#), [FDATool](#)

xlfd_a_numerator

The `xlfd_a_numerator` function returns the numerator of the filter object stored in the Xilinx FDATool block.

Syntax

```
[num] = xlfd_a_numerator(FDATool_name);
```

Description

Returns the numerator of the filter object stored in the Xilinx FDATool block named `FDATool_name`, or throws an error if the named block does not exist. The block name can be local (e.g. 'FDATool'), relative (e.g. '../FDATool'), or absolute (e.g. 'untitled/foo/bar/FDATool').

See Also

[xlfd_a_denominator](#), [FDATool](#)

xlGenerateButton

The `xlGenerateButton` function provides a programmatic way to invoke the System Generator code generator.

Syntax

```
status = xlGenerateButton(sysgenblock)
```

Description

`xlGenerateButton` invokes the System Generator code generator and returns a status code. Invoking `xlGenerateButton` with a System Generator block as an argument is functionally equivalent to opening the System Generator GUI for that token, and clicking on the **Generate** button. The following is list of possible status codes returned by `xlGenerateButton`.

Table 34: xlGenerateButton Status Codes

Status	Description
1	Canceled
2	Simulation running
3	Check param error
4	Compile/generate netlist error
5	Netlister error
6	Post netlister script error
7	Post netlist error
8	Post generation error
9	External view mismatch when importing as a configurable Subsystem

See Also

[xlgetparam](#) and [xlsetparam](#), [xlgetparams](#), [System Generator](#) block

xlgetparam and xlsetparam

Used to get and set parameter values in the [System Generator](#) token. Both functions are similar to the Simulink `get_param` and `set_param` commands and should be used for the System Generator token instead of the Simulink functions.

Syntax

```
[value1, value2, ...] = xlgetparam(sysgenblock, param1, param2, ...)
xlsetparam(sysgenblock, param1, value1, param2, value2, ...)
```

Description

The [System Generator](#) token differs from other blocks in one significant manner; multiple sets of parameters are stored for an instance of a System Generator token. The different sets of parameters stored correspond to different compilation targets available to the System Generator token. The 'compilation' parameter is the switch used to toggle between different compilation targets stored in the System Generator token. In order to get or set parameters associated with a particular compilation type, it is necessary to first use `xlsetparam` to change the 'compilation' parameter to the correct compilation target, before getting or setting further values.

```
[value1, value2, ...] = xlgetparam(sysgenblock, param1, param2, ...)
```

The first input argument of `xlgetparam` should be a handle to the [System Generator](#) block. Subsequent arguments are taken as names of parameters. The output returned is an array that matched the number of input parameters. If a requested parameter does not exist, the returned value of `xlgetparam` is empty. The `xlgetparams` function can be used to get all the parameters for the current compilation target.

```
xlsetparam(sysgenblock, param1, value1, param2, value2, ...)
```

The `xlsetparam` function also takes a handle to a System Generator token as the first argument. Subsequent arguments must be provided in pairs, the first should be the parameter name and the second the parameter value.

Specifying the Compilation Parameter

The 'compilation' parameter on the System Generator token captures the compilation type chosen; for example 'HDL Netlist' or 'IP Catalog'. As previously stated, when a compilation type is changed, the System Generator token will remember all the options chosen for that particular compilation type. For example, when 'HDL Netlist' is chosen, the corresponding target directory could be set to 'hdl_dir', but when 'IP Catalog' is chosen, the target directory could point to a different location, for example 'ip_cat_dir'. Changing the compilation type causes the System Generator token to recall previous options made for that compilation type. If the compilation type is selected for the first time, default values are used to populate the rest of the options on the System Generator token.

When using `xlsetparam` to set the compilation type of a System Generator token, be aware of the above behaviour, since the order in which parameters are set is important; be careful to first set a block's 'compilation' type before setting any other parameters.

When `xlsetparam` is used to set the 'compilation' parameter, it must be the only parameter that is being set on that command. For example, the form below is not permitted:

```
xlsetparam(sysgenblock, 'compilation', 'HDL Netlist', 'synthesis_tool',  
'Vivado synthesis')
```

Examples

Example 1: Changing the synthesis tool used for HDL netlist.

```
xlsetparam(sysgenblock, 'compilation', 'HDL Netlist');  
xlsetparam(sysgenblock, 'synthesis_tool', 'Vivado synthesis')
```

The first `xlsetparam` is used to set the compilation target to 'HDL Netlist'. The second `xlsetparam` is used to change the synthesis tool used to 'Vivado synthesis'.

Example 2: Getting family and part information.

```
[fam, part]=xlgetparam(sysgenblock, 'xilinxfamily', 'part')  
fam =  
Virtex2  
part =  
xc2v1000
```

See Also

[xlGenerateButton](#), [xlgetparams](#)

xlgetparams

The `xlgetparams` command is used to get all parameter values in a [System Generator](#) token associated with the current compilation type. The `xlgetparams` command can be used in conjunction with the `xlgetparam` and `xlsetparam` commands to change or retrieve a System Generator token's parameters.

Syntax

```
paramstruct = xlgetparams(sysgenblock_handle);
```

To get the `sysgenblock_handle`, enter `gbc` or `gcbh` at the MATLAB command line.

```
paramstruct = xlgetparams('chip/ System Generator');
paramstruct = xlgetparams(gcb);
paramstruct = xlgetparams(gcbh);
```

Description

All the parameters available to a [System Generator](#) block can be retrieved using the `xlgetparams` command. For more information regarding the parameters, please refer to the System Generator token documentation.

```
paramstruct = xlgetparams(sysgenblock);
```

The first input argument of `xlgetparams` should be a handle to the System Generator token. The function returns a MATLAB structure that lists the parameter value pairs.

The `compilation_lut` parameter is another structure that lists the other compilation types that are stored in this System Generator token. Using `xlsetparam` to set the compilation type allows the parameters associated with that compilation type to be visible to either `xlgetparams` or `xlgetparam`.

See Also

[xlGenerateButton](#), [xlgetparam](#) and [xlsetparam](#)

xlGetReOrderedCoeff

The `xlGetReOrderedCoeff` function provides the re-ordered coefficient set of a FIR Compiler block.

Syntax

```
A = xlGetReOrderedCoeff(new_coeff_set, returnType, block_handle)
```

Description

Note: All three parameters of this function are required.

`new_coeff_set`

The new coefficient set that needs to be loaded into an existing FIR Compiler. Must be supplied to the function in the original order.

block_handle

This is the FIR Compiler block handle in the design. If a FIR Compiler block is selected, then this block_handle can be specified as gcbh.

returnType

This parameter specifies the re-ordered coefficient or just the reload order information format. This value can be specified as either 'coeff' or 'index'. A 'coeff' return type will modify the required coefficient set and provide the re-arranged coefficient set that can be directly supplied to the FIR compiler block. The 'index' return type provides only the coefficient address vector using the new_coeff_set that needs to be processed manually.

Examples

Example 1:

If A is a row vector of coefficients, then the coefficients sorted in the reload order can be obtained as follows:

```
reload_order_coefficients = xlGetReOrderedCoeff(A, 'coeff', gcbh)
```

In this example, reload_order_coefficients specifies the order in which coefficients contained in A should be passed to the FIR Compiler through the reload channel.

Example 2:

This example shows how to use an input text file is generated.

```
reload_order_coefficients =  
xlGetReOrderedCoeff(A, 'coeff', reload_<version>.txt)
```

Alternatively, the reload address vector can be obtained,

```
reload_order_coefficients = A(xlGetReOrderedCoeff(A, 'index', gcbh))
```

See Also

[FIR Compiler 7.2](#) block

xlOpenWaveFormData

Allow you to populate saved simulation waveform data into running Waveform Viewer instance.

Syntax

```
xlOpenWaveFormData('C:/wavedata/model_name.wdb')
```

How to Use

1. Make sure an instance of Waveform Viewer is opened in the current System Generator session.
2. Locate the waveform data file (model_name.wdb) you would like to open.

Note: Waveform data are saved under the wavedata directory.

3. Type xlOpenWaveFormData('C:/wavedata/model_name.wdb') in the MatLab console. Make sure you enter the absolute path of the waveform data file.
4. Observe the waveform data in Waveform Viewer

See Also

For information on using the Waveform Viewer to develop and troubleshoot your design, see this [link](#) in the Vivado Design Suite User Guide: Logic Simulation (UG900).

xlSetUseHDL

This function sets the 'Use behavioral HDL' option of blocks in a model or Subsystem.

Syntax

```
xlSetUseHDL(system, mode)
```

Description

The model or system specified in the parameter system is set to either use cores or behavioral HDL, depending on the mode. Mode is a number, where 0 refers to using cores, and 1 refers to using behavioral HDL.

Examples

Example 1:

```
xlSetUseHDL(gcs, 0)
```

This call sets the currently selected system to use cores.

xlTBUtills

The xlTBUtills command provides access to several features of the Xilinx [ToolBar](#) block. This includes access to the layout, rerouting functions and to functions that return selected blocks and lines.

Syntax

```
xlTBUtills(function, args)
e.g.
xlTBUtills('ToolBar')
xlTBUtills('Layout',struct('verbose',1,'autoroute',0))
xlTBUtills('Layout',optionStruct)
xlTBUtills('Redrawlines',struct('autoroute',0))
xlTBUtills('RedrawLines',optionStruct)
[lines,blks]=xlTBUtills('GetSelected','All')
```

Description

xlTBUtills(function [,args])

xlTBUtills is a collection of functions that are used by the Xilinx Toolbar block. The function argument specifies the name of the function to execute. Further arguments (if required) can be tagged on as supplementary arguments to the function call. Note that the function argument string is not case sensitive. Possible values are enumerated below and explained further in the relevant subtopics.

Table 35: Function Argument

Function	Description
'ToolBar'	Launches the Xilinx Toolbar GUI. If the GUI is already open, it is brought to the front.
'Layout'	Runs the layout algorithm on a model to place and reroute lines on the model. Layout can be customized using the option structure that is detailed below.
'RedrawLines'	Runs the routing algorithm on a model to reroute lines on the model. RedrawLines can be customized using the option structure detailed below.
'GetSelected'	Returns MATLAB Simulink handles to blocks and lines that are selected on the system in focus

'xlTBUtills('Layout',optionStruct)

Automatically places and routes a Simulink model. optionStruct is a MATLAB struct data-type, that contains the parameters for Layout. The optionStruct argument is optional.

Layout expects circuits to be placed left to right. After placement, Layout uses Simulink to autoroute the wire connections. Simulink will route avoiding anything visible on screen, including block labels. Setting "ignore_labels" will 'allow' Simulink to route over labels – after which it is possible to manually move the labels to a more reasonable location. Note that field names are case sensitive.

Table 36: optionStruct Argument

Field Names	Description [Default values]
x_pitch, y_pitch	The gaps (pitch) between block (pixels). x_pitch specifies the amount of spacing to leave between blocks horizontally, and y_pitch specifies vertical spacing. [30].
x_start, y_start	Left (x_start) and top(y_start) margin spacing (pixels). The amount of spacing to leave on the left and top of a model. [10].
autoroute	Turns on Simulink auto-routing of lines. (1 0) [1]
ignore_labels	When auto-routing lines, Simulink will attempt to auto-route around text labels. Setting ignore_labels to 1 will minimize text label size during the routing process.
sys	Name of the system to layout. [gcs]
verbose	When set to 1, a wait bar is shown during the layout process.

xITBUtils('RedrawLines',optionStruct)

The RedrawLines command will redraw all lines in a Simulink model. If there are lines selected, only selected lines are redrawn otherwise all lines are redrawn. If a branch is selected, the entire line is redrawn; main trunk and all other sub-branches.

Table 37: RedrawLines Command

Field Names	Description [Default values]
autoroute	Turns on Simulink auto-routing of lines. (1 0) [1]
sys	Name of the system to layout. [gcs]

xITBUtils('GetSelected',handle,arg)

The GetSelected command returns handles to selected blocks and lines of the system in focus. The argument handle returns the Simulink model, in which the blocks and lines are selected. You can also provide the model name in place of the argument handle. The argument `arg` should be one of the string values described in the following table.

Table 38: GetSelected Command

GetSelected	Description [Default values]
'all'	Gets both selected lines and blocks.
'lines'	Gets only selected lines.
'blocks'	Gets only selected blocks.

The GetSelected command will return an array with two items, an array of a structure containing line information (lines) and an array of block handles (blks). If the 'lines' argument is used, blks is an empty array; similarly when the 'blocks' argument is used, lines is an empty array.

Examples

Example 1a: Performing Layouts

```
a.verbose = 1;
a.autoroute= 0;
x1TBUtils('Layout',a);
```

This will invoke the layout tool with verbose on and autoroute off.

Example 1b: Performing Layouts

```
x1TBUtils('Layout',struct('verbose',1,'autoroute',0));
```

This will also invoke the layout tool with verbose on and autoroute off.

Example 2: Redrawing lines

```
x1TBUtils('Redrawlines',struct('autoroute',0));
```

This will redraw the lines of the current system, with auto-routing off.

Example 3: Getting selected lines and blocks

```
x1TBUtils('GetSelected',handle,'all')
lines =

1x3 struct array with fields:
    Handle
    Name
    Parent
    SrcBlock
    SrcPort
    DstBlock
    DstPort
    Points
    Branch

blks =

1.0e+003 *

3.0320
3.0480
```

This will return all selected lines and blocks in the current system. In this case, 3 lines and 2 blocks were selected. The first line handle can be accessed using the command

```
lines(1).Handle
ans =
3.0740e+003
```

The handle to the first block can be accessed using the command

```
blks(1)
ans =
3.0320e+003
```

Remarks

The actions performed by Layout and RedrawLines will not be in the undo stack. Save a copy of the model before performing the actions, in order to revert to the original model.

This product contains certain software code or other information ("AT&T Software") proprietary to AT&T Corp. ("AT&T"). The AT&T Software is provided to you "AS IS". YOU ASSUME TOTAL RESPONSIBILITY AND RISK FOR USE OF THE AT&T SOFTWARE. AT&T DOES NOT MAKE, AND EXPRESSLY DISCLAIMS, ANY EXPRESS OR IMPLIED WARRANTIES OF ANY KIND WHATSOEVER, INCLUDING, WITHOUT LIMITATION, THE IMPLIED WARRANTIES OF MERCHANTABILITY OR FITNESS FOR A PARTICULAR PURPOSE, WARRANTIES OF TITLE OR NON-INFRINGEMENT OF ANY INTELLECTUAL PROPERTY RIGHTS, ANY WARRANTIES ARISING BY USAGE OF TRADE, COURSE OF DEALING OR COURSE OF PERFORMANCE, OR ANY WARRANTY THAT THE AT&T SOFTWARE IS "ERROR FREE" OR WILL MEET YOUR REQUIREMENTS.

Unless you accept a license to use the AT&T Software, you shall not reverse compile, disassemble or otherwise reverse engineer this product to ascertain the source code for any AT&T Software.

© AT&T Corp. All rights reserved. AT&T is a registered trademark of AT&T Corp.

See Also

[Toolbar](#), [xlAddTerms](#)

Programmatic Access

System Generator API for Programmatic Generation

Introduction

A script of System Generator for programmatic generation (PG API script) is a MATLAB M-function file that builds a System Generator Subsystem by instantiating and interconnecting `xBlock`, `xSignal`, `xInport`, and `xOutport` objects. It is a programmatic way of constructing System Generator diagrams (for example, Subsystems). As is demonstrated below with examples, the top-level function of a System Generator programmatic script is its entry point and must be invoked through an `xBlock` constructor. Upon constructor exit, MATLAB adds the corresponding System Generator Subsystem to the corresponding model. If no model is opened, a new untitled model is created and the System Generator Subsystem is inserted into it.

The `xBlock` constructor creates an `xBlock` object. The object can be created from a library block or it can be a Subsystem. An `xSignal` object corresponds to a wire that connects a source block to a target. An `xInport` object instantiates a Simulink Inport and an `xOutport` object instantiates a Simulink Outport.

The API also has one helper function, `xlsub2script` which converts a Simulink diagram to a programmatic generation script.

The API works in three modes: *learning mode*, *production mode*, and *debugging mode*. The learning mode allows you to type in the commands without having a physical script file. It is very useful when you learn the API. In this mode, all blocks, ports and Subsystems are added into a Simulink model named `untitled`. Please remember to run `xBlock` without any argument or to close the untitled model before starting a new learning session. The production mode has an M-function file and is invoked through the `xBlock` constructor. You will have a Subsystem generated. The Subsystem can be either in the existing model or can be inserted in a new model. The debugging mode works the same as the production mode except that every time a new object is created or a new connection is established, the Simulink diagram is rerouted. It is very useful when you debug the script that you set some break points in the script or single step the script.

xBlock

The `xBlock` constructor creates an `xBlock` object. The object can be created from a library block or it can be a Subsystem. The `xBlock` constructor can be used in three ways:

- to add a leaf block to the current Subsystem,
- to add a Subsystem to the current Subsystem,
- to attach a top-level Subsystem to a model.

The `xBlock` takes four arguments and is invoked as follows.

```
block = xBlock(source, params, inports, outports);
```

If the source argument is a string, it is expected to be a library block name. If the source block is in the `xbsIndex_r4` library or in the Simulink built-in library, you can use the block name without the library name. For example, calling `xBlock('AddSub', ...)` is equivalent to `xBlock('xbsIndex_r4/AddSub', ...)`. For a source block that is not in the `xbsIndex_r4` library or built-in library, you need to use the full path, for example, `xBlock('xbsTest_r4/AssertRelation', ...)`. If the source argument is a function handle, it is interpreted as a PG API function. If it is a MATLAB struct, it is treated as a configuration struc to specify how to attach the top-level to a model.

The `params` argument sets up the parameters. It can be a cell array for position-based binding or a MATLAB struct for name-based binding. If the source parameter is a block in a library, this argument must be a cell array. If the source parameter is a function pointer, this argument must be a cell array.

The `inports` and `outports` arguments specify how Subsystem input and output ports are bound. The binding can be a cell array for position-based binding or a MATLAB struct for name-based binding. When specifying an inport/outport binding, an element of a cell array can be an `xSignal`, an `xInport`, or an `xOutport` object. If the port binding argument is a MATLAB struct, a field of the struct is a port name of the block, a value of the struct is the object that the port is bound to.

The two port binding arguments are optional. If the arguments are missing when constructing the `xBlock` object, the port binding can be specified through the `bindParam` method of an `xBlock` object. The `bindParam` method is invoked as follows:

```
block.bindPort(inports, outports)
```

where `inports` and `outports` arguments specify the input and output port binding. In this case, the object `block` is create by `xBlock` with only two arguments, the source and the parameter binding.

Other `xBlock` methods include the following.

- `names = block.getOutportNames` returns a cell array of outport names.
- `names = block.getInportNames` returns a cell array of inport names.
- `nin = block.getNumInports` returns the number of inports.
- `nout = block.getNumoutports` returns the number of outports.
- `insigs = block.getInSignals` returns a cell array of in coming signals.
- `outsigs = block.getOutSignals` returns a cell array of out going signals.

xInport

An `xInport` object represents a Subsystem input port.

The constructor

```
port = xInport(port_name)
```

creates an `xInport` object with name `port_name`,

```
[port1, port2, port3, ...] = xInport(name1, name2, name2, ...)
```

creates a list of input port with names, and

```
port = xInport
```

creates an input port with an automatically generated name.

An `xInport` object can be passed for port binding.

METHODS

```
outsigs = port.getOutSignals
```

returns a cell array of out going signals.

xOutputport

An `xOutputport` object represents a Subsystem output port.

The constructor

```
port = xOutputport(port_name)
```

creates an `xOutputport` object with name `port_name`,

```
[port1, port2, port3, ...] = xOutputport(name1, name2, name2, ...)
```

creates a list of output port with names, and

```
port = xOutputport
```

creates an output port with an automatically generated name.

An `xOutput` object can be passed for port binding.

METHODS

```
port.bind(obj)
```

connects the object to port, where port is an `xOutput` object and obj is an `xSignal` or `xInport` object.

```
insigs = port.getInSignals
```

returns a cell array of incoming signals.

xSignal

An `xSignal` represents a signal object that connects a source to targets.

The constructor

```
sig = xSignal(sig_name)
```

creates an `xSignal` object with name `sig_name`,

```
[sig1, sig2, sig3, ...] = xSignal(name1, name2, name2, ...)
```

creates a list of signals with names, and

```
sig = xSignal
```

creates an `xSignal` for which a name is automatically generated.

An `xSignal` object can be passed for port binding.

METHODS

```
sig.bind(obj)
```

connects the obj to sig, where sig is an `xSignal` object and obj is an `xSignal` or an `xInport` object.

```
src = sig.getSrc
```

returns a cell array of the source objects that are driving the `xSignal` object. The cell array can have at most one element. If the source is an input port, the source object is an `xInport` object. If the source is an output port of a block, the source object is a struct, having two fields `block` and `port`. The `block` field is an `xBlock` object and the `port` field is the port index.

```
dst = sig.getDst
```

returns a cell array of the destination objects that the `xSignal` object is driving. Each element can be either a struct or an `xOutput` object. It is defined same as the return value of the `getSrc` method.

xlsub2script

`xlsub2script` is a helper function that converts a Subsystem into the top level of a Sysgen script.

`xlsub2script(Subsystem)` converts the Subsystem into the top-level script. The argument can also be a model.

By default, the generated M-function file is named after the name of the Subsystem with white spaces replaced with underscores. Once the `xlsub2script` finishes, a help message will guide you how to use the generated script. The main purpose of this `xlsub2script` function is to make learning Sysgen Script easier. This is also a nice utility that allows you to construct a Subsystem using graphic means and then convert the Subsystem to a PG API M-function.

`xlsub2script(block)`, where `block` is a leaf block, prints out the `xBlock` call that creates the block.

The following are the limitations of `xlsub2script`.

- If the Subsystem has mask initialization code that contains function calls such as `gcb`, `set_param`, `get_param`, `add_block`, and so on, the function will error out and you must modify the mask initialization code to remove those Simulink calls.
- If there is an access to global variables inside the Subsystem, you need add corresponding mask parameters to the top Subsystem that you run the `xlsub2script`.
- If a block's link is broken, that block is skipped.

`xlsub2script` can also be invoked as the following:

```
xlsub2script(subsystem, options)
```

where `options` is a MATLAB struct. The `options` struct can have two fields: `forcewrite`, and `basevars`.

If `xlsub2script` is invoked for the same Subsystem the second time, `xlsub2script` will try to overwrite the existing M-function file. By default, `xlsub2script` will pop up a question dialog asking whether to overwrite the file or not. If the `forcewrite` field of the `options` argument is set to be true or 1, `xlsub2script` will overwrite the M-function file without asking.

Sometimes a Subsystem is depended on some variables in the MATLAB base workspace. In that case, when you run `xlsub2script`, you want `xlsub2script` to pick these base workspace variables and generate the proper code to handle base workspace variables. The `basevars` field of the `options` argument is for that purpose. If you want `xlsub2script` to pick up every variable in the base workspace, you need to set the `basevars` field to be `'all'`. If you want `xlsub2script` to selectively pick up some variables, you can set the `basevars` field to be a cell array of strings, where each string is a variable name.

The following are examples of calling `xlsub2script` with the `options` argument:

```
xlsub2script(Subsystem, struct('forcewrite', true));
xlsub2script(Subsystem, struct('forcewrite', true, 'basevars',
    'all'));
options.basevars = {'var1', 'var2', 'var3'};
xlsub2script(Subsystem, options);
xlsub2script(Subsystem, struct('basevars', {'var1', 'var2',
    'var3'}));
```

In MATLAB, if the field of a struct is a cell array, when you call the `struct()` function call, you need the extra `{}`.

xBlockHelp

`xBlockHelp(<block_name>)` prints out the parameter names and the acceptable values for the corresponding parameters. When you execute `xBlockHelp` without a parameter, the available blocks in the `xbsIndex_r4` library are listed.

For example, when you execute the following in the MATLAB command line:

```
xBlockHelp('AddSub')
```

You'll get the following table in the transcript:

```
'xbsIndex_r4/AddSub' Parameter Table
```

Parameter	Acceptable value	Type
mode	'Addition' 'Subtraction' 'Addition or Subtraction'	String
use_carryin	'off' 'on'	String
use_carryout	'off' 'on'	String
en	'off' 'on'	String

latency	An Int value	Int
precision	'Full' 'User Defined'	String
arith_type	'Signed (2's comp)' 'Unsigned'	String
n_bits	An Int value	Int
bin_pt	An Int value	Int
quantization	'Truncate' 'Round (unbiased: +/- Inf)'	String
overflow	'Wrap' 'Saturate' 'Flag as error'	String
use_behavioral_HDL	'off' 'on'	String
pipelined	'off' 'on'	String
use_rpm	'off' 'on'	String

PG API Examples

Hello World

In this example, you will run the PG API in the *learning* mode where you can type the commands in the MATLAB® command shell.

1. To start a new learning session, in MATLAB command console, run: `xBlock`.
2. Type the following three commands in MATLAB command console to create a new Subsystem named 'Subsystem' inside a new model named 'untitled'.

```
[a, b] = xInport('a', 'b');
s = xOutport('s');
adder = xBlock('AddSub', struct('latency', 1), {a, b}, {s});
```

Figure 164: Subsystem Example

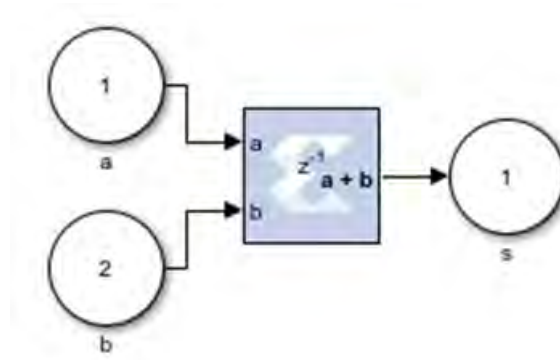

The above commands create the Subsystem with two Simulink Inports `a` and `b`, an adder block having a latency of one, and a Simulink Outputport `s`. The two Inports source the adder which in turn sources the Subsystem output. The `AddSub` parameter refers to the `AddSub` block inside the `xbsIndex_r4` library. By default, if the full block path is not specified, `xBlock` will search `xbsIndex_r4` and built-in libraries in turn. The library must be loaded before using `xBlock`. So please use `load_system` to load the library before invoking `xBlock`.



TIP: If you type `adder` in the MATLAB console, System Generator will print a brief description of the adder block to the MATLAB console and the block is highlighted in the Simulink diagram. Similarly, you can type `a`, `b`, and `s` to highlight Subsystem Inports and Outputs.

MACC

1. Run this example in the learning mode. To start a new learning session, run: `xBlock`.
2. Type the following commands in the MATLAB console window to create a multiply-accumulate function in a new Subsystem.

```
[a, b] = xInport('a', 'b');
mac = xOutport('mac');
m = xSignal;
mult = xBlock('Mult', struct('latency', 0, 'use_behavioral_HDL', 'on'),
{a, b},
{m});
acc = xBlock('Accumulator', struct('rst', 'off', 'use_behavioral_HDL',
'on'), {m},
{mac});
```

By directing System Generator to generate behavioral HDL, the two blocks should be packed into a single DSP48 block. As of this writing, Vivado synthesis only does so if you force the multiplier block to be combinational.

Figure 165: Forcing a Mult Block

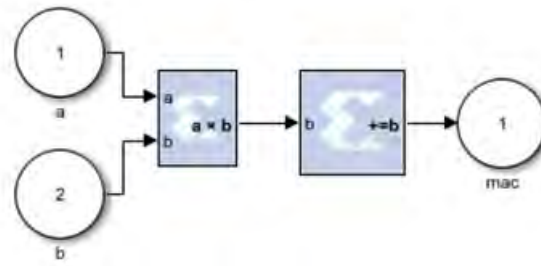

Note: If you do not close the model that is created in example 1, example 2 is created in a model named `untitled1`. Otherwise, a new model, `untitled`, is created for this example.



TIP: The PG API provides functions to get information about blocks and signals in the generated Subsystem. After each of the following commands, observe the output in the MATLAB console and the effect on the Simulink diagram.

```
mult_ins = mult.getInSignals
mult_ins{1}
mult_ins{2}
src_a = mult_ins{1}.getSrc
src_a{1}
m_dst = m.getDst
m_dst{1}
m_dst{1}.block
```

MACC in a Masked Subsystem

If you want a particular Subsystem to be generated by the PG API and pass parameters from the mask parameters of that Subsystem to PG API, you need to run the PG API in *production* mode, where you need to have a physical M-function file and pass that function to the `xBlock` constructor.

1. First create the top-level PG API M-function file `MACC_sub.m` with the following lines.

```
function MACC_sub(latency, nbits)
[a, b] = xInport('a', 'b');
mac = xOutport('mac');
if latency <= 0
    error('latency must be positive');
elseif latency == 1
    a_in = a; b_in = b;
else
    [a_in, b_in] = xSignal;
    dblock1 = xBlock('Delay', struct('latency', latency - 1,
    'reg_retiming', 'on'),
    {a}, {a_in});
    block2 = xBlock('Delay', struct('latency', latency - 1,
    'reg_retiming', 'on'),
    {b}, {b_in});
```

```

end
m = xSignal;
mult = xBlock('Mult', struct('latency', 0, 'use_behavioral_HDL', 'on'),
{a_in,
b_in}, {m});
acc = xBlock('Accumulator', struct('rst', 'off', 'n_bits', nbits,
'use_behavioral_HDL', 'on'), {m}, {mac});
    
```

Figure 166: Top-Level PG API M-Function File

```

function MACC_sub(latency, nbits)

    [a, b] = xImport('a', 'b');
    mac = xOutputport('mac');

    if latency <= 0
        error('latency must be positive');
    elseif latency == 1
        a_in = a; b_in = b;
    else
        [a_in, b_in] = xSignal;
        dblock1 = xBlock('Delay', struct('latency', latency - 1, 'reg_retiming', 'on'), {a}, {a_in});
        block2 = xBlock('Delay', struct('latency', latency - 1, 'reg_retiming', 'on'), {b}, {b_in});
    end

    m = xSignal;
    mult = xBlock('Mult', struct('latency', 0, 'use_behavioral_HDL', 'on'), {a_in, b_in}, {m});
    acc = xBlock('Accumulator', struct('rst', 'off', 'n_bits', nbits, 'use_behavioral_HDL', 'on'), {m}, {mac});
end
    
```

- To mask the Subsystem defined by the script, add two mask parameters latency and nbits.

Figure 167: Adding Latency Parameter

The screenshot shows the 'Parameters & Dialog' tab of the System Generator interface. The 'Dialog box' section contains a table with the following data:

Type	Prompt	Name
	%<MaskType>	DescGroupVar
	%<MaskDescription>	DescTextVar
	Parameters	ParameterGroupVar
#1	latency	latency
#2	nbits	nbits

The 'Property editor' on the right shows the properties for the selected 'latency' parameter:

- Name: latency
- Value: 1
- Prompt: latency
- Type: edit
- Evaluate:
- Tunable: on
- Read only:

- Then put the following lines to the mask initialization of the Subsystem.

```

config.source = str2func('MACC_sub');
config.toplevel = gcb;
xBlock(config, {latency, nbits});
    
```

In the *production* mode, the first argument of the `xBlock` constructor is a MATLAB struct for configuration, which must have a `source` field and a `toplevel` field. The `source` field is a function pointer pointing to the M-function and the `toplevel` is a string specifying the Simulink Subsystem. If the top-level field is 1, an untitled model is created and a Subsystem inside that model is created.

Figure 168: Adding `nbits` Parameter

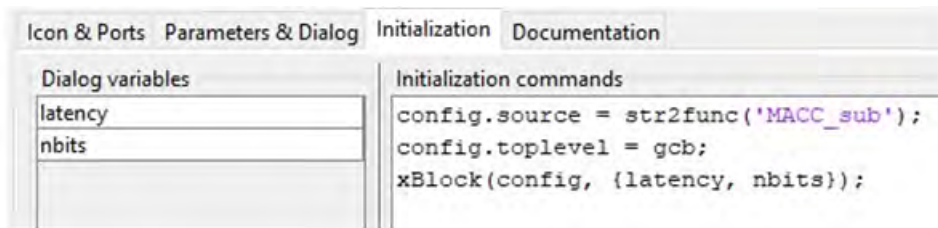

Alternatively you can use the MATLAB struct call to create the `toplevel` configuration:

```
xBlock(struct('source', str2func(MACC_sub), 'toplevel', gcb), {latency,
nbits});
```

Then click **OK**.

You'll get the following Subsystem.

Figure 169: Creating Toplevel Configuration

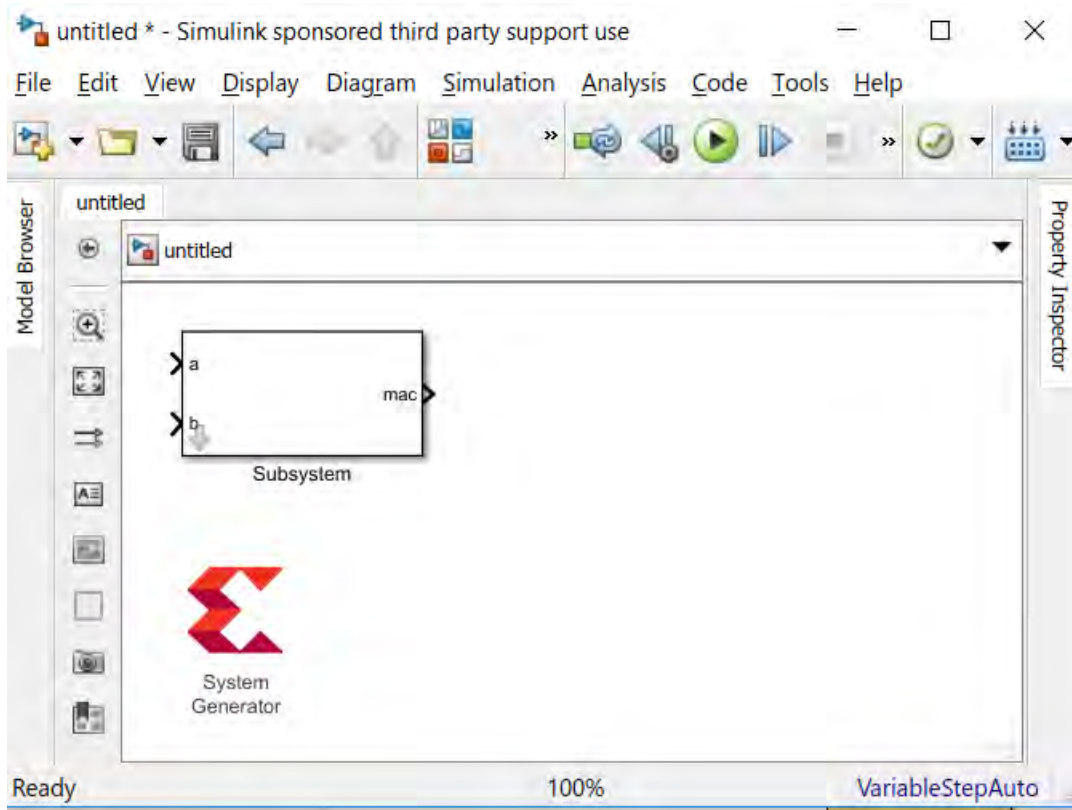

4. Set the mask parameters as shown in the following figure, then click **OK**:

Figure 170: Adding Mask Parameters

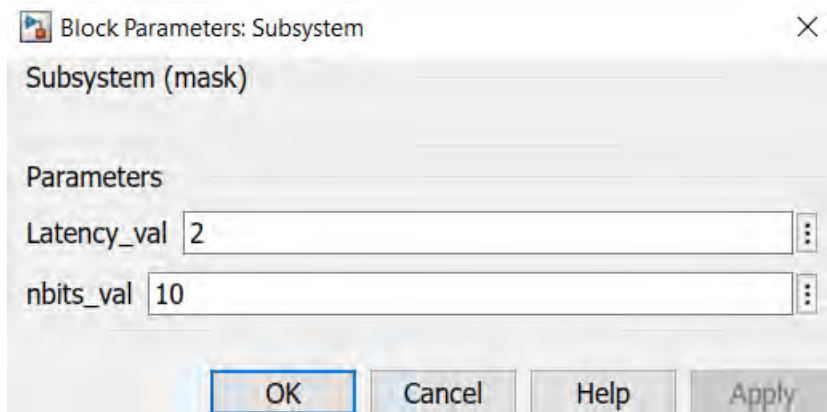

The following diagram is generated:

Figure 171: Generated Diagram

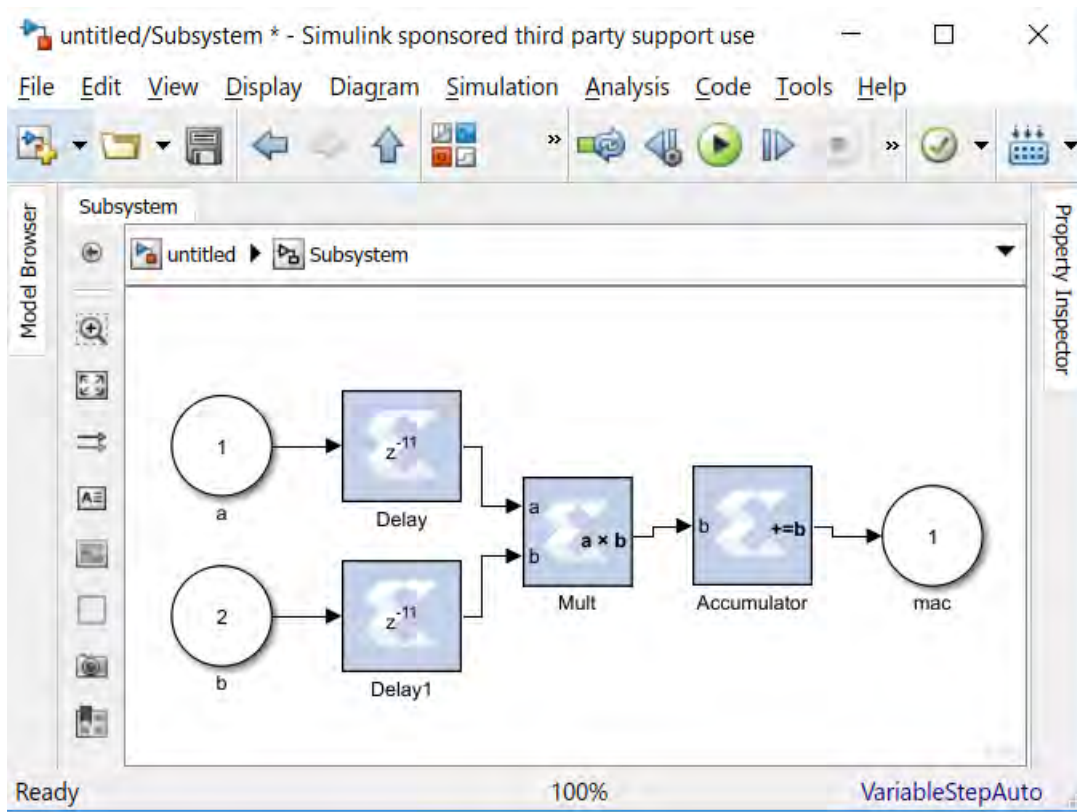

TIP: Open `MACC_sub.m` in the MATLAB editor to debug the function. By default the `xBlock` constructor will do an auto layout in the end. If you want to see the auto layout every time a block is added, invoke the toplevel `xBlock` as the following:

```
config.source = str2func('MACC_sub');
config.toplevel = gcb;
config.debug = 1;
xBlock(config, {latency, nbits});
```

By setting the debug field of the configuration struct to be 1, you run the PG API in debug mode where every action will trigger an auto layout.



TIP: Most often you only want to re-generate the Subsystem if needed. The `xBlock` constructor has a caching mechanism. You can specify the list of dependent files in a cell array, and set the `depend` field of the toplevel configuration with this list. If any file in the 'depend' list is changed, or the argument list that passed to the toplevel function is changed, the Subsystem is re-generated. If you want to have the caching capability for the `MACC_sub`, invoke the toplevel `xBlock` as the following:

```
config.source = str2func('MACC_sub');
config.toplevel = gcb;
config.depend = {'MACC_sub.m'};
xBlock(config, {latency, nbits});
```

The `depend` field of the configuration struct is a cell array. Each element of the array is a file name. You can put a p-file name or an M-file name. You can also put a name without a suffix. The `xBlock` will use the first in the path.

PG API Error/Warning Handling and Messages

xBlock Error Messages

Condition	Error Message(s)
When calling <code>xBlock(NoSubSourceBlock,)</code> and the source block does not exist	Source block <code>NoSubSourceBlock</code> cannot be found.
When calling <code>xBlock(sourceblock, parameterBinding)</code> , and the parameters are illegal, <code>xBlock</code> will report the Illegal parameterization error. For example, <code>xBlock('AddSub', struct('latency', -1))</code> ;	Illegal parameterization: Latency Latency is set to a value of -1, but the value must be greater than or equal to 0
When the input port binding list contains objects other than <code>xSignal</code> or <code>xInport</code> :	Only objects of <code>xInport</code> or <code>xSignal</code> can appear in inport binding list.
When the output port binding list contains objects other than <code>xSignal</code> or <code>xOutport</code> :	Only objects of <code>xOutport</code> or <code>xSignal</code> can appear in output binding list.
If the first argument of <code>xBlock</code> is a function pointer, the 2nd argument of <code>xBlock</code> is expected to be a cell array, otherwise, an error is thrown:	Cell array is expected for the second argument of the <code>xBlock</code> call
If the source configuration struct has <code>toplevel</code> defined, it must point to a Simulink® Subsystem and it must be a char array, otherwise, an error is thrown:	Top level must be a char array
If an object in the outport binding list has already been driven by something, for example, if you try to have two driving sources, an error is thrown.	Source of <code>xSignal</code> object already exists

xInport Error Messages

Condition	Error Message(s)
If you try to create an <code>xInport</code> object with the same name the second time, an error is thrown. For example, if you call <code>p = xInport('a', 'a')</code> .	A new block named 'untitled/Subsystem/a' cannot be added.

xOutput Error Messages

Condition	Error Message(s)
If you try to create an <code>xOutput</code> object with the same name the second time, an error is thrown. For example, if you call <code>p = xOutput('a', 'a')</code> .	A new block named 'untitled/Subsystem/a' cannot be added.
If you try to bind an <code>xOutput</code> object twice, an error is thrown. For example, the following sequence of calls will cause an error: <code>[a, b] = xInport('a', 'b');</code> <code>c = xOutput('c');</code> <code>c.bind(a); c.bind(b);</code>	The destination port already has a line connection.

xSignal Error Messages

Condition	Error Message(s)
If you try to bind an <code>xSignal</code> object with two sources, an error is thrown. For example, the following sequence of calls will cause an error: <code>[a, b] = xInport('a', 'b');</code> <code>sig = xSignal;</code> <code>sig.bind(a); sig.bind(b);</code>	Source of <code>xSignal</code> object already exists.

xsub2script Error Messages

Condition	Error Message(s)
<code>xsub2script</code> is invoked without any argument.	An argument is expected for <code>xsub2script</code>
The first argument is not a Subsystem or the model is not opened.	The first argument must be a model, Subsystem, or a block. Please make sure the model is opened or the argument is a valid string for a model or a block.
A Subsystem has Simulink function calls in its mask initialization code.	Subsystem has Simulink function calls, such as <code>gcb</code> , <code>get_param</code> , <code>set_param</code> , <code>add_block</code> . Please remove these calls and run <code>xsub2script</code> again or you can pick a different Subsystem to run <code>xsub2script</code> .
The Subsystem has Goto blocks.	You have the following Goto blocks, please modify the model to remove them and run <code>xsub2script</code> again.

M-Code Access to Hardware Co-Simulation

Hardware co-simulation in System Generator brings on-chip acceleration and verification capabilities into the Simulink simulation environment. In the typical System Generator flow, a System Generator model is first compiled for a hardware co-simulation platform, during which a hardware implementation (bitstream) of the design is generated and associated to a hardware co-simulation block. The block is inserted into a Simulink model and its ports are connected with appropriate source and sink blocks. The whole model is simulated while the compiled System Generator design is executed on an FPGA.

Alternatively, it is possible to programmatically control the hardware created through the System Generator hardware co-simulation flow using MATLAB M-code (M-Hwcosim). The M-Hwcosim interfaces allow for MATLAB objects that correspond to the hardware to be created in pure M-code, independent of the Simulink framework. These objects can then be used to read and write data into hardware.

This capability is useful for providing a scripting interface to hardware co-simulation, allowing for the hardware to be used in a scripted test bench or deployed as hardware acceleration in M-code. Apart from supporting the scheduling semantics of a System Generator simulation, M-Hwcosim also gives the flexibility for any arbitrary schedule to be used. This flexibility can be exploited to improve the performance of a simulation, if the user has apriori knowledge of how the design works. Additionally, the M-Hwcosim objects provide accessibility to the hardware from the MATLAB console, allowing for the hardware internal state to be introspected interactively.

Compiling Hardware for Use with M-Hwcosim

Compiling hardware for use in M-Hwcosim follows the same flow as the typical System Generator hardware co-simulation flow. You start off with a System Generator model in Simulink, select a hardware co-simulation target in the System Generator token and click Generate. At the end of the generation, a hardware co-simulation library is created.

Among other files in the netlist directory, you can find a bit file and an hwc file. The bit file corresponds to the FPGA implementation, and the hwc file contains information required for M-Hwcosim. Both bit file and hwc file are paired by name, e.g. mydesign_cw.bit and mydesign_cw.hwc.

The hwc file specifies additional meta information for describing the design and the chosen hardware co-simulation interface. With the meta information, a hardware co-simulation instance can be instantiated using M-Hwcosim, through which you can interact with the co-simulation engine.

M-Hwcosim inherits the same concepts of ports and fixed point notations as found in the existing co-simulation block. Every design exposes its top-level ports for external access.

M-Hwcosim Simulation Semantics

The simulation semantics for M-Hwcosim differs from that used during hardware co-simulation in a System Generator block diagram; the M-Hwcosim simulation semantics is more flexible and is capable of emulating the simulation semantics used in the block-based hardware co-simulation.

In the block-based hardware co-simulation, a rigid simulation semantic is imposed; before advancing a clock cycle, all the input ports of the hardware co-simulation are written to. Next all the output ports are read and the clock is advanced. In M-Hwcosim the scheduling of when ports are read or written to, is left to the user. For instance it would be possible to create a program that would only write data to certain ports on every other cycle, or to only read the outputs after a certain number of clock cycles. This flexibility allows users to optimize the transfer of data for better performance.

Data Representation

M-Hwcosim uses fixed point data types internally, while it consumes and produces double precision floating point values to external entities. All data samples passing through a port are fixed point numbers. Each sample has a preset data width and an implicit binary point position that are fixed at the compilation time. Data conversions (from double precision to fixed point) happen on the boundary of M-Hwcosim. In the current implementation, quantization of the input data is handled by rounding, and overflow is handled by saturation.

Interfacing to Hardware from M-Code

When a model has been compiled for hardware co-simulation, the generated bitstream can be used in both a model-based Simulink flow, or in M-code executed in MATLAB. The general sequence of operations to access a bitstream in hardware typically follows the sequence described below.

1. Configure the hardware co-simulation interface. Note that the hardware co-simulation configuration is persistent and is saved in the `hwc` file. If the co-simulation interface is not changed, there is no need to re-run this step.
2. Create a M-Hwcosim instance for a particular design.
3. Open the M-Hwcosim interface.
4. Repeatedly run the following sub-steps until the simulation ends.
5. Write simulation data to input ports.
6. Read simulation data from output ports.
7. Advance the design clock by one cycle.
8. Close the M-Hwcosim interface.
9. Release the M-Hwcosim instance.

Automatic Generation of M-Hwcosim Testbench

M-Hwcosim enables the test bench generation for hardware co-simulation. When the **Create testbench** option is checked in the System Generator token, the hardware co-simulation compilation flow generates an M-code script (`<design>_hwcosim_test.m`) and golden test data files (`<design>_<port>_hwcosim_test.dat`) for each gateway based on the Simulink simulation. The M-code script uses the M-Hwcosim API to implement a test bench that simulates the design in hardware and verifies the results against the golden test data. Any simulation mismatch is reported in a result file (`<design>_hwcosim_test.results`).

As shown below in the Example, the test bench code generated is easily readable and can be used as a basis for your own simulation code.

```

function multi_rates_cw_hwcosim_test
try
% Define the number of hardware cycles for the simulation.
ncycles = 10;

% Load input and output test reference data.
testdata_in2 = load('multi_rates_cw_in2_hwcosim_test.dat');
testdata_in3 = load('multi_rates_cw_in3_hwcosim_test.dat');
testdata_in7 = load('multi_rates_cw_in7_hwcosim_test.dat');
testdata_pb00 =
load('multi_rates_cw_pb00_hwcosim_test.dat');
testdata_pb01 =
load('multi_rates_cw_pb01_hwcosim_test.dat');
testdata_pb02 =
load('multi_rates_cw_pb02_hwcosim_test.dat');
testdata_pb03 =
load('multi_rates_cw_pb03_hwcosim_test.dat');
testdata_pb04 =
load('multi_rates_cw_pb04_hwcosim_test.dat');

% Pre-allocate memory for test results.
result_pb00 = zeros(size(testdata_pb00));
result_pb01 = zeros(size(testdata_pb01));
result_pb02 = zeros(size(testdata_pb02));
result_pb03 = zeros(size(testdata_pb03));
result_pb04 = zeros(size(testdata_pb04));

% Initialize sample index counter for each sample period to
be
% scheduled.
insp_2 = 1;
insp_3 = 1;
insp_7 = 1;
outsp_1 = 1;
outsp_2 = 1;
outsp_3 = 1;
outsp_7 = 1;

% Define hardware co-simulation project file.
project = 'multi_rates_cw.hwc';

% Create a hardware co-simulation instance.
h = Hwcosim(project);
    
```

```

hardware.      % Open the co-simulation interface and configure the
                try
                open(h);
                catch
user            % If an error occurs, launch the configuration GUI for the
                % to change interface settings, and then retry the process
again.         release(h);
                drawnow;
                h = Hwcosim(project);
                open(h);
                end

                % Simulate for the specified number of cycles.
                for i = 0:(ncycles-1)

                % Write data to input ports based their sample period.
                if mod(i, 2) == 0
                h('in2') = testdata_in2(insp_2);
                insp_2 = insp_2 + 1;
                end
                if mod(i, 3) == 0
                h('in3') = testdata_in3(insp_3);
                insp_3 = insp_3 + 1;
                end
                if mod(i, 7) == 0
                h('in7') = testdata_in7(insp_7);
                insp_7 = insp_7 + 1;
                end

                % Read data from output ports based their sample period.
                result_pb00(outsp_1) = h('pb00');
                result_pb04(outsp_1) = h('pb04');
                outsp_1 = outsp_1 + 1;
                if mod(i, 2) == 0
                result_pb01(outsp_2) = h('pb01');
                outsp_2 = outsp_2 + 1;
                end
                if mod(i, 3) == 0
                result_pb02(outsp_3) = h('pb02');
                outsp_3 = outsp_3 + 1;
                end
                if mod(i, 7) == 0
                result_pb03(outsp_7) = h('pb03');
                outsp_7 = outsp_7 + 1;
                end

                % Advance the hardware clock for one cycle.
                run(h);

                end

                % Release the hardware co-simulation instance.
                release(h);

                % Check simulation result for each output port.
                logfile = 'multi_rates_cw_hwcosim_test.results';
                logfd = fopen(logfile, 'w');
                sim_ok = true;
                sim_ok = sim_ok & check_result(logfd, 'pb00',
    
```



```

testdata_pb00, result_pb00);
    sim_ok = sim_ok & check_result(logfd, 'pb01',
testdata_pb01, result_pb01);
    sim_ok = sim_ok & check_result(logfd, 'pb02',
testdata_pb02, result_pb02);
    sim_ok = sim_ok & check_result(logfd, 'pb03',
testdata_pb03, result_pb03);
    sim_ok = sim_ok & check_result(logfd, 'pb04',
testdata_pb04, result_pb04);
    fclose(logfd);
    if ~sim_ok
        error('Found errors in simulation results. Please refer to
''%s'' for details.',
            logfile);
    end

    catch
    err = lasterr;
    try release(h); end
    error('Error running hardware co-simulation testbench. %s',
err);
    end

%-----

function ok = check_result(fd, portname, expected, actual)
ok = false;

fprintf(fd, ['\n' repmat('=', 1, 95), '\n']);
fprintf(fd, 'Output: %s\n\n', portname);

% Check the number of data values.
nvals_expected = numel(expected);
nvals_actual = numel(actual);
if nvals_expected ~= nvals_actual
differs ' ...
    fprintf(fd, ['The number of simulation output values (%d)
nvals_actual, nvals_expected);
return;
end

% Check for simulation mismatches.
mismatches = find(expected ~= actual);
num_mismatches = numel(mismatches);
if num_mismatches > 0
num_mismatches);
    fprintf(fd, 'Number of simulation mismatches = %d\n',
num_mismatches);
    fprintf(fd, '\n');
    fprintf(fd, 'Simulation mismatches:\n');
    fprintf(fd, '-----\n');
    fprintf(fd, '%10s %40s %40s\n', 'Cycle', 'Expected values',
'Actual values');
    fprintf(fd, '%10d %40.16f %40.16f\n', ...
[mismatches-1; expected(mismatches); actual(mismatches)]);
return;
end

    ok = true;
    fprintf(fd, 'Simulation OK\n');

```

Selecting the Adapter for Point-to-Point Ethernet Hardware Co-Simulation with M-Hwcosim

When you are performing Point-to-Point Ethernet Hardware Co-Simulation using M-Hwcosim, you can select the desired Ethernet interface if there are multiple adapters.

This can be achieved with the following sequence of MATLAB console commands:

1. Get the M-Hwcosim object.

```
h = Hwcosim('<model_name.hwc>')
```

for example:

```
h = Hwcosim('sysgenFSE.hwc')
```

2. Get the information for all of the Ethernet adapters.

```
>> ifc_arr = xLPPEthernetCosimGetAdapters;
```

`xLPPEthernetCosimGetAdapters` is a helper function to list all available Ethernet adapters in the system into a MATLAB struct array.

3. Find the human-readable names of the adapters and find the index of the desired adapter.

```
>> ifc_arr.desc
```

Example output is shown below.

```
>> ifc_arr.desc
```

```
ans =
```

```
Please select an Ethernet interface
```

```
ans =
```

```
Infineon AN983/AN985/ADM9511 NDIS5 64-bits X64 Driver  
(00:1e:e5:d6:d5:fd)
```

```
ans =
```

```
Broadcom NetXtreme Gigabit Ethernet Driver (bc:30:5b:d2:23:0b
```

The first index is always "Please select an Ethernet interface". The other indexes are the device description string, the device name, the MAC address, the connection speed, and the maximum frame size of each Ethernet adapter.

4. Select the index of the Ethernet Adapter connected to the board and set the `ethernetInterfaceID` property in the M-Hwcosim object. Here the second entry (Infineon adapter) is used.

```
>> set(h, 'ethernetInterfaceID', ifc_arr(2).dev);
```

Resource Management

M-Hwcosim manages resources that it holds for a hardware co-simulation instance. It releases the held resources upon the invocation of the release instruction or when MATLAB exits. However, it is recommended to perform an explicit cleanup of resources when the simulation finishes or throws an error. To allow proper cleanup in case of errors, it is suggested to enclose M-Hwcosim instructions in a MATLAB try-catch block as illustrated below.

```
try
% M-Hwcosim instructions here
catch
err = lasterror;
% Release any Hwcosim instances
try release(hwcosim_instance); end
rethrow(err);
end
```

The following command can be used to release all hardware co-simulation instances.

```
xlHwcosim('release');           % Release all Hwcosim instances
```

M-Hwcosim MATLAB Class

The `Hwcosim` MATLAB class provides a higher level abstraction of the hardware co-simulation engine. Each instantiated `Hwcosim` object represents a hardware co-simulation instance. It encapsulates the properties, such as the unique identifier, associated with the instance. Most of the instruction invocations take the `Hwcosim` object as an input argument. For further convenience, alternative shorthand is provided for certain operations.

Actions	Syntax
Constructor	<code>h = Hwcosim(project)</code>
Destructor	<code>release(h)</code>
Open hardware	<code>open(h)</code>
Close hardware	<code>close(h)</code>
Write data	<code>write(h, 'portName', inData);</code>
Read data	<code>outData = read(h, 'portName');</code>
Run	<code>run(h);</code>
Port information	<code>portinfo(h);</code>
Set property	<code>set(h, 'propertyName', propertyValue);</code>
Get property	<code>propertyValue = get(h, 'propertyName');</code>

Constructor

Syntax

```
h = Hwcosim(project);
```

Description

Creates an Hwcosim instance. Note that an instance is a reference to the hardware co-simulation project and does not signify an explicit link to hardware; creating a Hwcosim object informs the Hwcosim engine where to locate the FPGA bitstream, it does not download the bitstream into the FPGA. The bitstream is only downloaded to the hardware after an open command is issued.

The project argument should point to the hwc file that describes the hardware co-simulation.

Creating the Hwcosim object will list all input and output ports. The example below shows the output of a call to the Hwcosim constructor, displaying the ID of the object and a list of all the input and output gateways/ports.

```
>> h = Hwcosim(p)
System Generator Hardware Co-simulation Object
  id: 30247
  inports:
    gateway_in
    gateway_in2
  outports:
    gateway_out
```

Destructor

Syntax

```
release(h);
```

Description

Releases the resources used by the Hwcosim object h. If a link to hardware is still open, release will first close the hardware.

Open Hardware

Syntax

```
open(h);
```

Description

Opens the connection between the host PC and the FPGA. Before this function can be called, the hardware co-simulation interface must be configured. The argument, `h`, is a handle to an `Hwcosim` object.

Close hardware

Syntax

```
close(h);
```

Description

Closes the connection between the host PC and the FPGA. The argument, `h`, is a handle to an `Hwcosim` object.

Write data

Syntax

```
h('portName') = inData; %If inData is array, results in burst write.
h('portName') = [1 2 3 4];
write(h, 'portName', inData);
write(h, 'portName', [1 2 3 4]); %burst mode
```

Description

Ports are referenced by their legalized names. Name legalization is a requirement for VHDL and Verilog synthesis, and converts names into all lower-case, replaces white space with underscores, and adds unique suffixes to avoid namespace collisions. To find out what the legalized input and output port names are, run the helper command `portinfo(h)`, or see the output of `Hwcosim` at the time of instance creation.

`inData` is the data to be written to the port. Normal single writes are performed if `inData` is a scalar value. If burst mode is enabled and `inData` is a `1xn` array, it will be interpreted as a timeseries and written to the port via burst data transfer.

Read data

Syntax

```
outData = h('portName');
outData = h('portName', 25); %burst mode
```

```
outData = read(h, 'portName');
outData = read(h, 'portName', 25); %burst
```

Description

Ports are referenced by their legalized names (see previous class above).

If burst mode is enabled, and depending on whether the read command has 3 or 4 parameters (2 or 3 parameters in the case of a subscript reference `h('portName', ...)`), `outData` will be assigned a scalar or a 1xn array. If an array, the data is the result of a burst data transfer.

Run

Syntax

```
run(h);
run(h, n);
run(h, inf); %start free-running clock
run(h, 0); %stop free-running clock
```

Description

When the hardware co-simulation object is configured to run in single-step mode, the `run` command is used to advance the clock. `run(h)` will advance the clock by one cycle. `run(h,n)` will advance the clock by `n` cycles.

The `run` command is also used to turn on (and off) free-running clock mode: `run(h, inf)` will start the free-running clock and `run(h, 0)` will stop it.

A read of an output port will need to be preceded either by a 'dummy' run command or by a write, in order to force a synchronization of the read cache with the hardware.

Port Information

Syntax

```
portinfo(h);
```

Description

This method will return a MATLAB struct array with fields `inports` and `outports`, which themselves are struct arrays holding all input and output ports, respectively, again represented as struct arrays. The fieldnames of the individual port structs are the legalized portnames themselves, so you may obtain a cell array of input port names suitable for Hwcosim `write` commands by issuing these commands:

```
a = portinfo(h);
inports = fieldnames(a.inports);
```

You can issue a similar series of commands for output ports (`outports`).

Additional information contained in the port structs are `simulink_name`, which provides the fully hierarchical Simulink name including spaces and line breaks, `rate`, which contains the signal's rate period with respect to the DUT clock, `type`, which holds the System Generator data type information, and, if burst mode is enabled, `fifo_depth`, indicating the maximum size of data bursts that can be sent to Hardware in a batch.

Set property

Syntax

```
set(h, 'propertyName', propertyValue);
```

Description

The `set` method sets or changes any of the contents of the internal properties table of the Hwcosim instance `h`. It is required that `h` already exists before calling this method.

Examples

```
set(h, 'booleanProperty', logical(0));
set(h, 'integerProperty', int32(12345));
set(h, 'doubleProperty', pi);
set(h, 'stringProperty', 'Rosebud!');
```

For a practical application of the `set` property method in the context of Point-to-Point Ethernet Hardware Co-Simulation, see [Selecting the Adapter for Point-to-Point Ethernet Hardware Co-Simulation with M-Hwcosim](#)

Get property

Syntax

The get property method returns the value of any of the contents of the internal properties table in the Hwcosim instance `h`, referenced by the `propertyName` key. It is required that `h` already exists before calling this method. If the `propertyName` key does not exist in `h`, the method throws an exception and prints an error message.

Examples

```
bool_val = get(h, 'booleanProperty');  
int_val = get(h, 'integerProperty');  
double = get(h, 'doubleProperty');  
str_val = get(h, 'stringProperty');
```

M-Hwcosim Utility Functions

xlHwcosim

Syntax

```
xlHwcosim('release');
```

Description

When M-Hwcosim objects are created global system resources are used to register each of these objects. These objects are typically freed when a release command is called on the object. `xlHwcosim` provides an easy way to release all resources used by M-Hwcosim in the event of an unexpected error. The release functions for each of the objects should be used if possible because the `xlHwcosim` call release the resources for all instances of a particular type of object.

Example

```
xlHwcosim('release') %release all instances of Hwcosim objects.
```

Additional Resources and Legal Notices

Documentation Navigator and Design Hubs

Xilinx® Documentation Navigator (DocNav) provides access to Xilinx documents, videos, and support resources, which you can filter and search to find information. To open DocNav:

- From the Vivado® IDE, select **Help** → **Documentation and Tutorials**.
- On Windows, select **Start** → **All Programs** → **Xilinx Design Tools** → **DocNav**.
- At the Linux command prompt, enter `docnav`.

Xilinx Design Hubs provide links to documentation organized by design tasks and other topics, which you can use to learn key concepts and address frequently asked questions. To access the Design Hubs:

- In DocNav, click the **Design Hubs View** tab.
- On the Xilinx website, see the [Design Hubs](#) page.

Note: For more information on DocNav, see the [Documentation Navigator](#) page on the Xilinx website.

References

- *Vivado Design Suite Reference Guide: Model-Based DSP Design Using System Generator* ([UG958](#))
- *Vivado Design Suite Tutorial: Model-Based DSP Design Using System Generator* ([UG948](#))
- *Vivado Design Suite User Guide: Using the Vivado IDE* ([UG893](#))
- *Vivado Design Suite User Guide: Design Flows Overview* ([UG892](#))
- *ISE to Vivado Design Suite Migration Guide* ([UG911](#))
- *Vivado Design Suite User Guide: Designing with IP* ([UG896](#))
- *Vivado Design Suite User Guide: Using Constraints* ([UG903](#))

- *Vivado Design Suite User Guide: Using Tcl Scripting* ([UG894](#))
- *Vivado Design Suite Tutorial: Design Flows Overview* ([UG888](#))
- *Vivado Design Suite User Guide: System-Level Design Entry* ([UG895](#))
- *Vivado Design Suite User Guide: Release Notes, Installation, and Licensing* ([UG973](#))
- *UltraFast Design Methodology Guide for Xilinx FPGAs and SoCs* ([UG949](#))

Please Read: Important Legal Notices

The information disclosed to you hereunder (the "Materials") is provided solely for the selection and use of Xilinx products. To the maximum extent permitted by applicable law: (1) Materials are made available "AS IS" and with all faults, Xilinx hereby DISCLAIMS ALL WARRANTIES AND CONDITIONS, EXPRESS, IMPLIED, OR STATUTORY, INCLUDING BUT NOT LIMITED TO WARRANTIES OF MERCHANTABILITY, NON-INFRINGEMENT, OR FITNESS FOR ANY PARTICULAR PURPOSE; and (2) Xilinx shall not be liable (whether in contract or tort, including negligence, or under any other theory of liability) for any loss or damage of any kind or nature related to, arising under, or in connection with, the Materials (including your use of the Materials), including for any direct, indirect, special, incidental, or consequential loss or damage (including loss of data, profits, goodwill, or any type of loss or damage suffered as a result of any action brought by a third party) even if such damage or loss was reasonably foreseeable or Xilinx had been advised of the possibility of the same. Xilinx assumes no obligation to correct any errors contained in the Materials or to notify you of updates to the Materials or to product specifications. You may not reproduce, modify, distribute, or publicly display the Materials without prior written consent. Certain products are subject to the terms and conditions of Xilinx's limited warranty, please refer to Xilinx's Terms of Sale which can be viewed at <https://www.xilinx.com/legal.htm#tos>; IP cores may be subject to warranty and support terms contained in a license issued to you by Xilinx. Xilinx products are not designed or intended to be fail-safe or for use in any application requiring fail-safe performance; you assume sole risk and liability for use of Xilinx products in such critical applications, please refer to Xilinx's Terms of Sale which can be viewed at <https://www.xilinx.com/legal.htm#tos>.

AUTOMOTIVE APPLICATIONS DISCLAIMER

AUTOMOTIVE PRODUCTS (IDENTIFIED AS "XA" IN THE PART NUMBER) ARE NOT WARRANTED FOR USE IN THE DEPLOYMENT OF AIRBAGS OR FOR USE IN APPLICATIONS THAT AFFECT CONTROL OF A VEHICLE ("SAFETY APPLICATION") UNLESS THERE IS A SAFETY CONCEPT OR REDUNDANCY FEATURE CONSISTENT WITH THE ISO 26262 AUTOMOTIVE SAFETY STANDARD ("SAFETY DESIGN"). CUSTOMER SHALL, PRIOR TO USING

OR DISTRIBUTING ANY SYSTEMS THAT INCORPORATE PRODUCTS, THOROUGHLY TEST SUCH SYSTEMS FOR SAFETY PURPOSES. USE OF PRODUCTS IN A SAFETY APPLICATION WITHOUT A SAFETY DESIGN IS FULLY AT THE RISK OF CUSTOMER, SUBJECT ONLY TO APPLICABLE LAWS AND REGULATIONS GOVERNING LIMITATIONS ON PRODUCT LIABILITY.

Copyright

© Copyright 2012-2020 Xilinx, Inc. Xilinx, the Xilinx logo, Alveo, Artix, Kintex, Spartan, Versal, Virtex, Vivado, Zynq, and other designated brands included herein are trademarks of Xilinx in the United States and other countries. All other trademarks are the property of their respective owners.