

# ISE In-Depth Tutorial

UG695 (v13.1) March 1, 2011



The information disclosed to you hereunder (the "Information") is provided "AS-IS" with no warranty of any kind, express or implied. Xilinx does not assume any liability arising from your use of the Information. You are responsible for obtaining any rights you may require for your use of this Information. Xilinx reserves the right to make changes, at any time, to the Information without notice and at its sole discretion. Xilinx assumes no obligation to correct any errors contained in the Information or to advise you of any corrections or updates. Xilinx expressly disclaims any liability in connection with technical support or assistance that may be provided to you in connection with the Information. XILINX MAKES NO OTHER WARRANTIES, WHETHER EXPRESS, IMPLIED, OR STATUTORY, REGARDING THE INFORMATION, INCLUDING ANY WARRANTIES OF MERCHANTABILITY, FITNESS FOR A PARTICULAR PURPOSE, OR NONINFRINGEMENT OF THIRD-PARTY RIGHTS.

© Copyright 2011 Xilinx, Inc. XILINX, the Xilinx logo, Virtex, Spartan, ISE, and other designated brands included herein are trademarks of Xilinx in the United States and other countries. All other trademarks are the property of their respective owners.

## Revision History

The following table shows the revision history for this document.

Date	Version	Revision
03/01/11	13.1	<ul style="list-style-type: none"><li>• Changed tutorial directory to: <code>c:\xilinx_tutorial</code></li><li>• Updated CORE Generator software graphics.</li><li>• Updated third party synthesis tool versions.</li></ul>

# Table of Contents

---

Revision History .....	2
<b>Chapter 1: Introduction</b>	
About the In-Depth Tutorial .....	5
Tutorial Contents .....	5
Tutorial Flows .....	6
<b>Chapter 2: Overview of ISE Software</b>	
Software Overview .....	7
Using Project Revision Management Features .....	11
<b>Chapter 3: HDL-Based Design</b>	
Overview of HDL-Based Design .....	13
Getting Started .....	13
Design Description .....	17
Design Entry .....	18
Synthesizing the Design .....	33
<b>Chapter 4: Schematic-Based Design</b>	
Overview of Schematic-Based Design .....	41
Getting Started .....	41
Design Description .....	43
Design Entry .....	46
<b>Chapter 5: Behavioral Simulation</b>	
Overview of Behavioral Simulation Flow .....	75
ModelSim Setup .....	75
ISim Setup .....	75
Getting Started .....	76
Adding an HDL Test Bench .....	78
Behavioral Simulation Using ModelSim .....	79
Behavioral Simulation Using ISim .....	85
<b>Chapter 6: Design Implementation</b>	
Overview of Design Implementation .....	91
Getting Started .....	91
Specifying Options .....	93
Creating Timing Constraints .....	94

Translating the Design .....	94
Using the Constraints Editor .....	95
Assigning I/O Locations Using PlanAhead Software .....	101
Mapping the Design .....	104
Using Timing Analysis to Evaluate Block Delays After Mapping .....	106
Placing and Routing the Design .....	108
Using FPGA Editor to Verify the Place and Route .....	109
Evaluating Post-Layout Timing .....	111
Creating Configuration Data .....	113
Command Line Implementation .....	116

## Chapter 7: Timing Simulation

Overview of Timing Simulation Flow .....	117
Getting Started .....	117
Timing Simulation Using ModelSim .....	118
Timing Simulation Using Xilinx ISim .....	126

## Chapter 8: Configuration Using iMPACT

Overview of iMPACT .....	131
Device Support .....	131
Download Cable Support .....	131
Configuration Mode Support .....	131
Getting Started .....	132
Using Boundary-Scan Configuration Mode .....	133
Troubleshooting Boundary-Scan Configuration .....	140
Creating an SVF File .....	141

## Appendix A: Additional Resources

Xilinx Resources .....	147
ISE Documentation .....	147

# Introduction

---

## About the In-Depth Tutorial

This tutorial gives a description of the features and additions to the Xilinx® ISE® Design Suite. The primary focus of this tutorial is to show the relationship among the design entry tools, Xilinx and third-party tools, and the design implementation tools.

This guide is a learning tool for designers who are unfamiliar with the features of the ISE software or those wanting to refresh their skills and knowledge.

You may choose to follow one of the three tutorial flows available in this document. For information about the tutorial flows, see [Tutorial Flows](#).

## Tutorial Contents

This guide covers the following topics:

- [Chapter 2, Overview of ISE Software](#), introduces you to the primary user interface for the ISE software, Project Navigator, and the synthesis tools available for your design.
- [Chapter 3, HDL-Based Design](#), guides you through a typical HDL-based design procedure using a design of a runner's stopwatch. This chapter also shows how to use ISE software accessories, such as the CORE Generator™ software and ISE Text Editor.
- [Chapter 4, Schematic-Based Design](#), explains many different facets of a schematic-based ISE software design flow using a design of a runner's stopwatch. This chapter also shows how to use ISE software accessories, such as the CORE Generator software and ISE Text Editor.
- [Chapter 5, Behavioral Simulation](#), explains how to simulate a design before design implementation to verify that the logic that you have created is correct.
- [Chapter 6, Design Implementation](#), describes how to Translate, Map, Place, Route, and generate a bitstream file for designs.
- [Chapter 7, Timing Simulation](#), explains how to perform a timing simulation using the block and routing delay information from the routed design to give an accurate assessment of the behavior of the circuit under worst-case conditions.
- [Chapter 8, Configuration Using iMPACT](#), explains how to program a device with a newly created design using the IMPACT configuration tool.

## Tutorial Flows

This document contains three tutorial flows. In this section, the three tutorial flows are outlined and briefly described to help you determine which sequence of chapters applies to your needs. The tutorial flows include the following:

- HDL design flow
- Schematic design flow
- Implementation-only flow

### HDL Design Flow

The HDL design flow is as follows:

1. [Chapter 3, HDL-Based Design](#)
2. [Chapter 5, Behavioral Simulation](#)  
**Note:** Although behavioral simulation is optional, it is strongly recommended in this tutorial flow.
3. [Chapter 6, Design Implementation](#)
4. [Chapter 7, Timing Simulation](#)  
**Note:** Although timing simulation is optional, it is strongly recommended in this tutorial flow.
5. [Chapter 8, Configuration Using iMPACT](#)

### Schematic Design Flow

The schematic design flow is as follows:

1. [Chapter 4, Schematic-Based Design](#)
2. [Chapter 5, Behavioral Simulation](#)  
**Note:** Although behavioral simulation is optional, it is strongly recommended in this tutorial flow.
3. [Chapter 6, Design Implementation](#)
4. [Chapter 7, Timing Simulation](#)  
**Note:** Although timing simulation is optional, it is strongly recommended in this tutorial flow.
5. [Chapter 8, Configuration Using iMPACT](#)

### Implementation-Only Flow

The implementation-only flow is as follows:

1. [Chapter 6, Design Implementation](#)
2. [Chapter 7, Timing Simulation](#)  
**Note:** Although timing simulation is optional, it is strongly recommended in this tutorial flow.
3. [Chapter 8, Configuration Using iMPACT](#)

# Overview of ISE Software

---

## Software Overview

The ISE® software controls all aspects of the design flow. Through the Project Navigator interface, you can access all of the design entry and design implementation tools. You can also access the files and documents associated with your project.

### Project Navigator Interface

By default, the Project Navigator interface is divided into four panel sub-windows, as seen in [Figure 2-1](#). On the top left are the Start, Design, Files, and Libraries panels, which include display and access to the source files in the project as well as access to running processes for the currently selected source. The Start panel provides quick access to opening projects as well as frequently access reference material, documentation and tutorials. At the bottom of the Project Navigator are the Console, Errors, and Warnings panels, which display status messages, errors, and warnings. To the right is a multi-document interface (MDI) window referred to as the Workspace. The Workspace enables you to view design reports, text files, schematics, and simulation waveforms. Each window can be resized, undocked from Project Navigator, moved to a new location within the main Project Navigator window, tiled, layered, or closed. You can use the **View > Panels** menu commands to open or close panels. You can use the **Layout > Load Default Layout** to restore the default window layout. These windows are discussed in more detail in the following sections.

The following figure shows the Project Navigator interface.

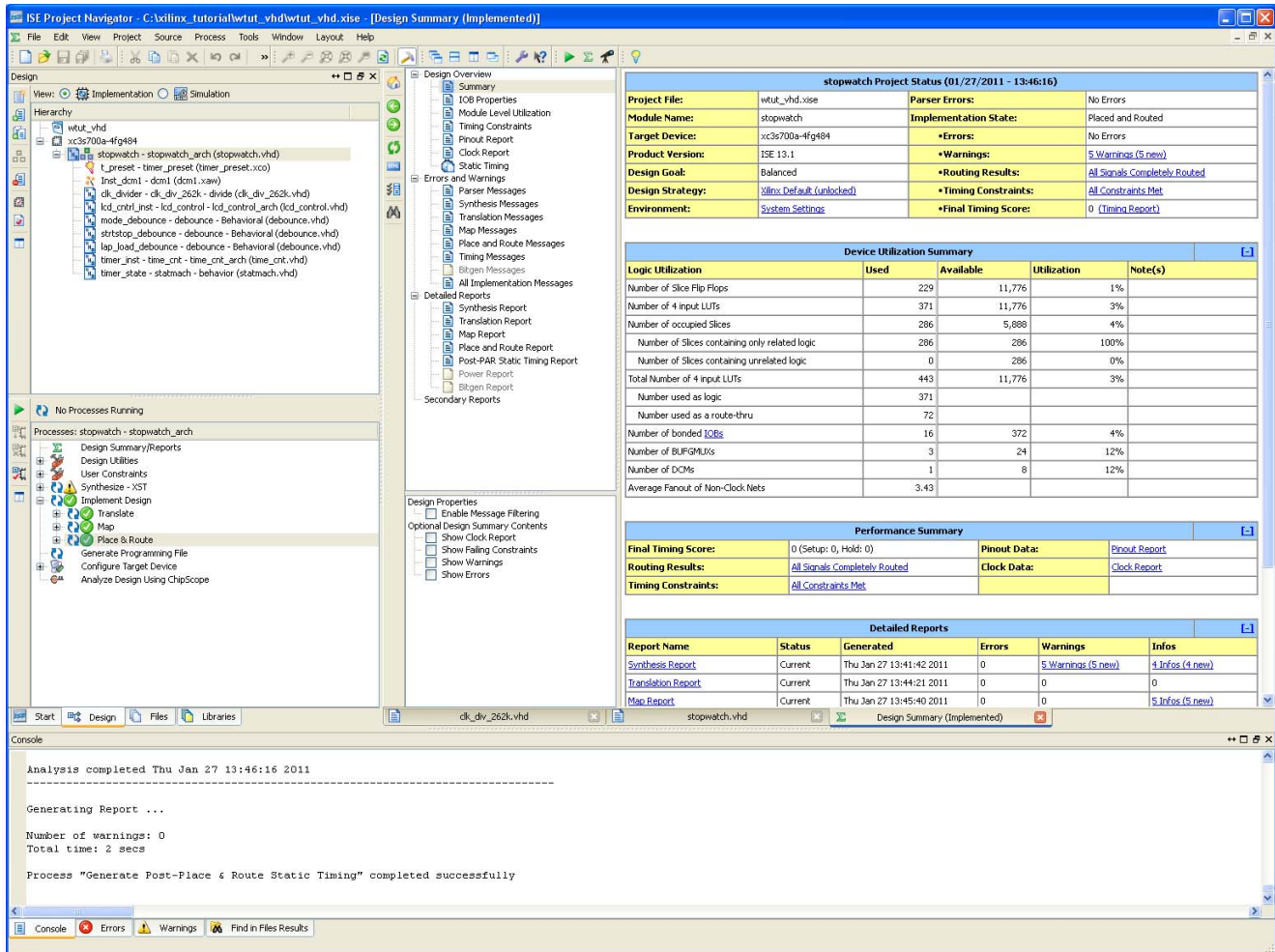

Figure 2-1: Project Navigator

## Design Panel

The Design panel provides access to the View, Hierarchy, and Processes panes.

## View Pane

The View pane radio buttons enable you to view the source modules associated with the Implementation or Simulation Design View in the Hierarchy pane. If you select Simulation, you must select a simulation phase from the drop-down list.

## Hierarchy Pane

The Hierarchy pane displays the project name, the target device, user documents, and design source files associated with the selected Design View. The View pane at the top of the Design panel allows you to view only those source files associated with the selected Design View, such as Implementation or Simulation.

Each file in the Hierarchy pane has an associated icon. The icon indicates the file type (HDL file, schematic, core, or text file, for example). For a complete list of possible source



types and their associated icons, see the “Source File Types” topic in the ISE Help. From Project Navigator, select **Help > Help Topics** to view the ISE Help.

If a file contains lower levels of hierarchy, the icon has a plus symbol (+) to the left of the name. You can expand the hierarchy by clicking the plus symbol (+). You can open a file for editing by double-clicking on the filename.

## Processes Pane

The Processes pane is context sensitive, and it changes based upon the source type selected in the Sources pane and the top-level source in your project. From the Processes pane, you can run the functions necessary to define, run, and analyze your design. The Processes pane provides access to the following functions:

- **Design Summary/Reports**  
Provides access to design reports, messages, and summary of results data. Message filtering can also be performed.
- **Design Utilities**  
Provides access to symbol generation, instantiation templates, viewing command line history, and simulation library compilation.
- **User Constraints**  
Provides access to editing location and timing constraints.
- **Synthesis**  
Provides access to Check Syntax, Synthesis, View RTL or Technology Schematic, and synthesis reports. Available processes vary depending on the synthesis tools you use.
- **Implement Design**  
Provides access to implementation tools and post-implementation analysis tools.
- **Generate Programming File**  
Provides access to bitstream generation.
- **Configure Target Device**  
Provides access to configuration tools for creating programming files and programming the device.

The Processes pane incorporates dependency management technology. The tools keep track of which processes have been run and which processes need to be run. Graphical status indicators display the state of the flow at any given time. When you select a process in the flow, the software automatically runs the processes necessary to get to the desired step. For example, when you run the Implement Design process, Project Navigator also runs the Synthesis process because implementation is dependent on up-to-date synthesis results.

To view a running log of command line arguments used on the current project, expand Design Utilities and select **View Command Line Log File**. See [Command Line Implementation in Chapter 6](#) for further details.

## Files Panel

The Files panel provides a flat, sortable list of all the source files in the project. Files can be sorted by any of the columns in the view. Properties for each file can be viewed and modified by right-clicking on the file and selecting **Source Properties**.

## Libraries Panel

The Libraries panel enables you to manage HDL libraries and their associated HDL source files. You can create, view, and edit libraries and their associated sources.

## Console Panel

The Console provides all standard output from processes run from Project Navigator. It displays errors, warnings, and information messages. Errors are signified by a red X next to the message; while warnings have a yellow exclamation mark (!).

## Errors Panel

The Errors panel displays only error messages. Other console messages are filtered out.

## Warnings Panel

The Warnings panel displays only warning messages. Other console messages are filtered out.

### Error Navigation to Source

You can navigate from a synthesis error or warning message in the Console, Errors, or Warnings panel to the location of the error in a source HDL file. To do so, select the error or warning message, right-click the mouse, and select **Go to Source** from the right-click menu. The HDL source file opens, and the cursor moves to the line with the error.

### Error Navigation to Answer Record

You can navigate from an error or warning message in the Console, Errors, or Warnings panel to relevant Answer Records on the [Support](#) page of the Xilinx® website. To navigate to the Answer Record, select the error or warning message, right-click the mouse, and select **Go to Answer Record** from the right-click menu. The default Web browser opens and displays all Answer Records applicable to this message.

## Workspace

The Workspace is where design editors, viewers, and analysis tools open. These include ISE Text Editor, Schematic Editor, Constraint Editor, Design Summary/Report Viewer, RTL and Technology Viewers, and Timing Analyzer.

Other tools such as the PlanAhead™ software for I/O planning and floorplanning, ISim, third-party text editors, XPower Analyzer, and iMPACT open in separate windows outside the main Project Navigator environment when invoked.

## Design Summary/Report Viewer

The Design Summary provides a summary of key design data as well as access to all of the messages and detailed reports from the synthesis and implementation tools. The summary lists high-level information about your project, including overview information, a device utilization summary, performance data gathered from the Place and Route (PAR) report, constraints information, and summary information from all reports with links to the individual reports. A link to the System Settings report provides information on environment variables and tool settings used during the design implementation.

Messaging features such as message filtering, tagging, and incremental messaging are also available from this view.

## Using Project Revision Management Features

Project Navigator enables you to manage your project as follows.

### Understanding the ISE Project File

The ISE project file (.xise extension) is an XML file that contains all source-relevant data for the project as follows:

- ISE software version information
- List of source files contained in the project
- Source settings, including design and process properties

The ISE project file does not contain the following:

- Process status information
- Command history
- Constraints data

**Note:** A .gise file also exists, which contains generated data, such as process status. You should not need to directly interact with this file.

The ISE project file includes the following characteristics, which are compatible with source control environments:

- Contains all of the necessary source settings and input data for the project.
- Can be opened in Project Navigator in a read-only state.
- Only updated or modified if a source-level change is made to the project.
- Can be kept in a directory separate from the generated output directory (working directory).

**Note:** A source-level change is a change to a property or the addition or removal of a source file. Changes to the contents of a source file or changes to the state of an implementation run are *not* considered source-level changes and do not result in an update to the project file.

### Making a Copy of a Project

You can create a copy of a project using **File > Copy Project** to experiment with different source options and implementations. Depending on your needs, the design source files for the copied project and their location can vary as follows:

- Design source files can be left in their existing location, and the copied project points to these files.
- Design source files, including generated files, can be copied and placed in a specified directory.
- Design source files, excluding generated files, can be copied and placed in a specified directory.

## Using the Project Browser

The Project Browser, accessible by selecting **File > Project Browser**, provides a convenient way to compare, view, and open projects as follows:

- Compare key characteristics between multiple projects.
- View Design Summary and Reports for a selected project before opening the full project.
- Compare detailed information for two selected projects.
- Open a selected project in the current Project Navigator session.
- Open a selected project in a new Project Navigator session.

## Using Project Archives

You can also archive the entire project into a single compressed file. This allows for easier transfer over email and storage of numerous projects in a limited space.

### Creating an Archive

To create an archive, do the following:

1. Select **Project > Archive**.
2. In the Project Archive dialog box, enter the archive name and location.
3. Click **Save**.

**Note:** The archive contains all of the files in the project directory along with project settings. Remote sources are included in the archive under a folder named `remote_sources`. For more information, see the ISE Help.

### Restoring an Archive

You cannot restore an archived file directly into Project Navigator. The compressed file can be extracted with any ZIP utility, and you can then open the extracted file in Project Navigator.

# HDL-Based Design

---

## Overview of HDL-Based Design

This chapter guides you through a typical HDL-based design procedure using a design of a runner's stopwatch. The design example used in this tutorial demonstrates many device features, software features, and design flow practices you can apply to your own design. This design targets a Spartan™-3A device; however, all of the principles and flows taught are applicable to any Xilinx® device family, unless otherwise noted.

The design is composed of HDL elements and two cores. You can synthesize the design using Xilinx Synthesis Technology (XST), Synplify/Synplify Pro, or Precision software.

This chapter is the first chapter in the [HDL Design Flow](#). After the design is successfully defined, you will perform behavioral simulation ([Chapter 5, Behavioral Simulation](#)), run implementation with the Xilinx implementation tools ([Chapter 6, Design Implementation](#)), perform timing simulation ([Chapter 7, Timing Simulation](#)), and configure and download to the Spartan-3A device (XC3S700A) demo board ([Chapter 8, Configuration Using iMPACT](#)).

## Getting Started

The following sections describe the basic requirements for running the tutorial.

### Required Software

To perform this tutorial, you must have Xilinx ISE® Design Suite installed.

This tutorial assumes that the software is installed in the default location `c:\xilinx\release_number\ISE_DS\ISE`. If you installed the software in a different location, substitute your installation path in the procedures that follow.

**Note:** For detailed software installation instructions, refer to the [ISE Design Suite: Installation and Licensing Guide \(UG798\)](#) available from the Xilinx website.

### Optional Software Requirements

The following third-party synthesis tools are incorporated into this tutorial and may be used in place of Xilinx Synthesis Technology (XST):

- Synopsys Synplify/Synplify Pro D-2010.06 (or above)
- Mentor Precision Synthesis 2010a (or above)

The following third-party simulation tool is optional for this tutorial and may be used in place of ISim:

- ModelSim SE/PE/DE 6.6d (or above)

## VHDL or Verilog

This tutorial supports both VHDL and Verilog designs and applies to both designs simultaneously, noting differences where applicable. You will need to decide which HDL language you would like to work through for the tutorial and download the appropriate files for that language. XST can synthesize a mixed-language design. However, this tutorial does not cover the mixed language feature.

## Installing the Tutorial Project Files

The tutorial project files are provided with the ISE Design Suite [Tutorials](#) available from the Xilinx website. Download either the VHDL or the Verilog design flow project files.

After you have downloaded the tutorial project files from the web, unzip the tutorial projects into the `c:\xilinx_tutorial` directory, replacing any existing files in that directory.

When you unzip the tutorial project files into `c:\xilinx_tutorial`, the directory `wtut_vhd` (for a VHDL design flow) or `wtut_ver` (for a Verilog design flow) is created within `c:\xilinx_tutorial`, and the tutorial files are copied into the newly-created directory.

The following table lists the locations of tutorial source files.

**Table 3-1: Tutorial Directories**

Directory	Description
<code>wtut_vhd</code>	Incomplete VHDL Source Files
<code>wtut_ver</code>	Incomplete Verilog Source Files
<code>wtut_vhd\wtut_vhd_completed</code>	Completed VHDL Source Files
<code>wtut_ver\wtut_ver_completed</code>	Completed Verilog Source Files

**Note:** The completed directories contain the finished HDL source files. Do not overwrite any files in the completed directories.

This tutorial assumes that the files are unzipped under `c:\xilinx_tutorial`, but you can unzip the source files into any directory with read/write permissions. If you unzip the files into a different location, substitute your project path in the procedures that follow.

## Starting the ISE Software

To start the ISE software, double-click the ISE Project Navigator icon on your desktop, or select **Start > All Programs > Xilinx ISE Design Suite > ISE Design Tools > Project Navigator**.



**Figure 3-1: Project Navigator Desktop Icon**

## Creating a New Project

To create a new project using the New Project Wizard, do the following:

1. From Project Navigator, select **File > New Project**.

The New Project Wizard appears.

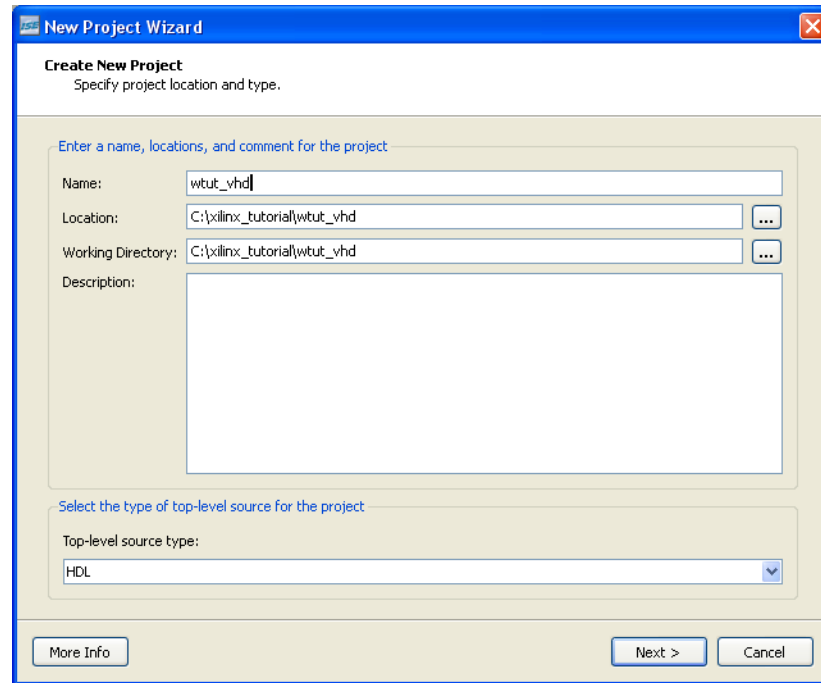

Figure 3-2: New Project Wizard—Create New Project Page

2. In the Location field, browse to `c:\xilinx_tutorial` or to the directory in which you installed the project.
3. In the Name field, enter `wtut_vhd` or `wtut_ver`.
4. Verify that **HDL** is selected as the Top-Level Source Type, and click **Next**.

The New Project Wizard—Device Properties page appears.

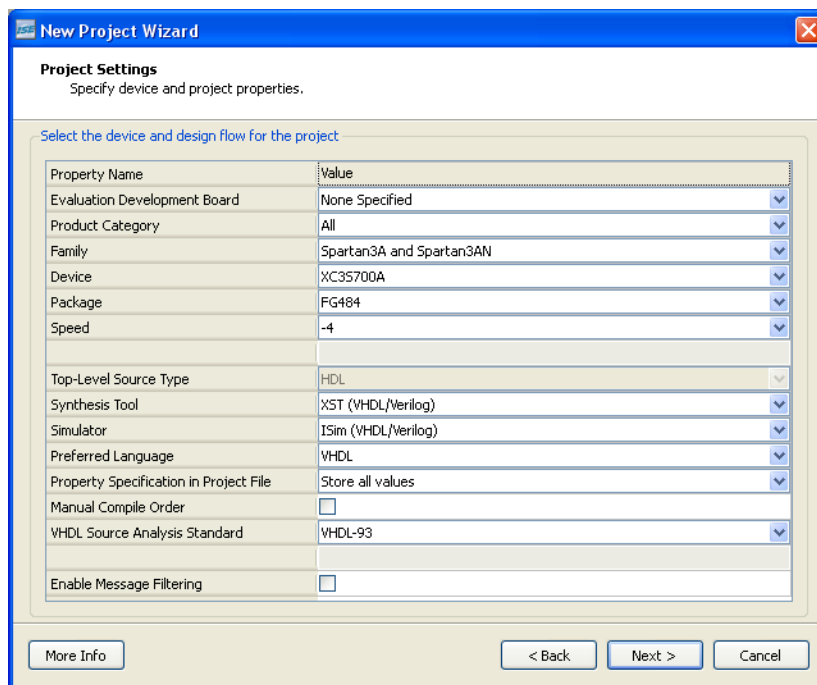

Figure 3-3: New Project Wizard—Device Properties Page

5. Select the following values in the New Project Wizard—Device Properties page:
  - Product Category: **All**
  - Family: **Spartan3A and Spartan3AN**
  - Device: **XC3S700A**
  - Package: **FG484**
  - Speed: **-4**
  - Synthesis Tool: **XST (VHDL/Verilog)**
  - Simulator: **ISim (VHDL/Verilog)**
  - Preferred Language: **VHDL** or **Verilog** depending on preference. This will determine the default language for all processes that generate HDL files.
 Other properties can be left at their default values.
6. Click **Next**, then **Finish** to complete the project creation.

## Stopping the Tutorial

You may stop the tutorial at any time and save your work by selecting **File > Save All**.



## Design Description

The design used in this tutorial is a hierarchical, HDL-based design, which means that the top-level design file is an HDL file that references several other lower-level macros. The lower-level macros are either HDL modules or IP modules.

The design begins as an unfinished design. Throughout the tutorial, you will complete the design by generating some of the modules from scratch and by completing others from existing files. When the design is complete, you will simulate it to verify the design functionality.

In the runner's stopwatch design, there are five external inputs and four external output buses. The system clock is an externally generated signal. The following list summarizes the input and output signals of the design.

### Inputs

The following are input signals for the tutorial stopwatch design:

- **strtstop**  
Starts and stops the stopwatch. This is an active low signal which acts like the start/stop button on a runner's stopwatch.
- **reset**  
Puts the stopwatch in clocking mode and resets the time to 0:00:00.
- **clk**  
Externally generated system clock.
- **mode**  
Toggles between clocking and timer modes. This input is only functional while the clock or timer is not counting.
- **lap\_load**  
This is a dual function signal. In clocking mode, it displays the current clock value in the 'Lap' display area. In timer mode, it loads the pre-assigned values from the ROM to the timer display when the timer is not counting.

### Outputs

The following are outputs signals for the design:

- **lcd\_e, lcd\_rs, lcd\_rw**  
These outputs are the control signals for the LCD display of the Spartan-3A demo board used to display the stopwatch times.
- **sf\_d[7:0]**  
Provides the data values for the LCD display.

### Functional Blocks

The completed design consists of the following functional blocks:

- **clk\_div\_262k**  
Macro that divides a clock frequency by 262,144. Converts 26.2144 MHz clock into 100 Hz 50% duty cycle clock.

- **dcm1**  
Clocking Wizard macro with internal feedback, frequency controlled output, and duty-cycle correction. The CLKFX\_OUT output converts the 50 MHz clock of the Spartan-3A demo board to 26.2144 MHz.
- **debounce**  
Schematic module implementing a simplistic debounce circuit for the strtstop, mode, and lap\_load input signals.
- **lcd\_control**  
Module controlling the initialization of and output to the LCD display.
- **statmach**  
State machine HDL module that controls the state of the stopwatch.
- **timer\_preset**  
CORE Generator™ software 64x20 ROM. This macro contains 64 preset times from 0:00:00 to 9:59:99 that can be loaded into the timer.
- **time\_cnt**  
Up/down counter module that counts between 0:00:00 to 9:59:99 decimal. This macro has five 4-bit outputs, which represent the digits of the stopwatch time.

## Design Entry

For this hierarchical design, you will examine HDL files, correct syntax errors, create an HDL macro, and add a CORE Generator software core and a clocking module. You will create and use each type of design macro. All procedures used in the tutorial can be used later for your own designs.

### Adding Source Files

HDL files must be added to the project before they can be synthesized. You will add five source files to the project as follows:

1. Select **Project > Add Source**.
2. Select the following files (.vhd files for VHDL design entry or .v files for Verilog design entry) from the project directory, and click **Open**.
  - clk\_div\_262k
  - lcd\_control
  - statmach
  - stopwatch
  - time\_cnt
3. In the Adding Source Files dialog box, verify that the files are associated with **All**, that the associated library is **work**, and click **OK**.

The Hierarchy pane in the Design panel displays all of the source files currently added to the project, with the associated entity or module names. Each source design unit is represented in the Hierarchy pane using the following syntax: *instance name - entity name - architecture name - (file name)*.

Instantiated components with no entity or module declaration are displayed with a question mark.

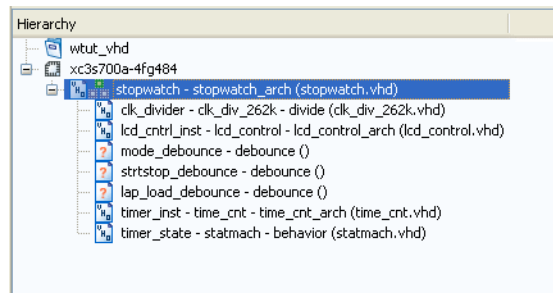

Figure 3-4: Hierarchy Panel Showing Completed Design

## Correcting HDL Errors

The syntactical correctness of the files is checked as the files are added to the project, and also when they are saved. Messages are posted in the Console and in the Parser Messages section of the Design Summary and indicate the success or failure as each of the files is parsed.

The time\_cnt module contains a syntax error that must be corrected. An “ERROR” message in the Console indicates the failure and provides a summary and the line number of the syntax problem.

To display the error in the source file, do the following:

1. In the Console or Errors panel, click the file name in the error message.  
The source code appears in the Workspace with a yellow arrow icon next to the line with the error.
2. Correct any errors in the HDL source file. The comments above the error explain this simple fix.
3. Select **File > Save** to save the file.

The parsing message in the Console should now indicate that the file was checked successfully and is now free of errors.

## Creating an HDL-Based Module

Next you will create a module from HDL code. With the ISE software, you can easily create modules from HDL code using the ISE Text Editor. The HDL code is then connected to your top-level HDL design through instantiation and is compiled with the rest of the design.

You will author a new HDL module. This macro will be used to debounce the strtstop, mode and lap\_load inputs.

## Using the New Source Wizard and ISE Text Editor

In this section, you create a file using the New Source wizard, specifying the name and ports of the component. The resulting HDL file is then modified in the ISE Text Editor.

To create the source file, do the following:

1. Select **Project > New Source**.

The New Source Wizard opens in which you specify the type of source you want to create.

2. In the Select Source Type page, select **VHDL Module** or **Verilog Module**.
3. In the File Name field, enter **debounce**.

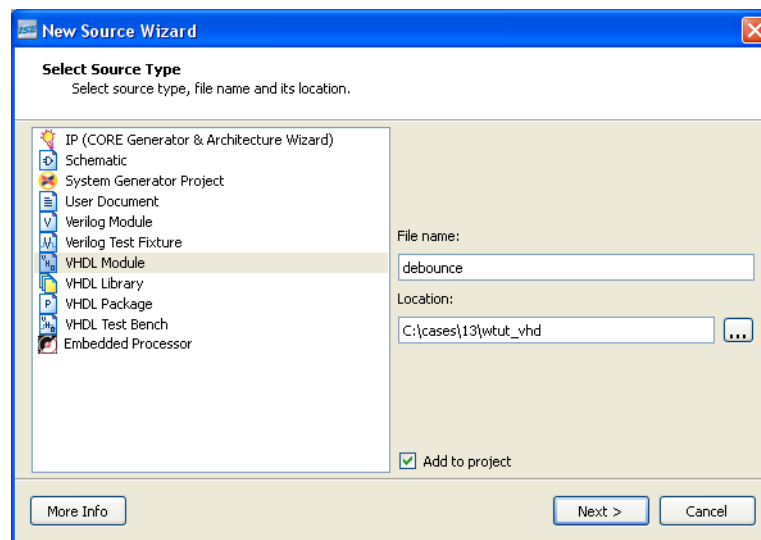

Figure 3-5: New Source Wizard—Select Source Type Page

4. Click **Next**.
5. In the Define Module page, enter two input ports named `sig_in` and `clk` and an output port named `sig_out` for the debounce component as follows:
  - a. In the first three Port Name fields, enter **sig\_in**, **clk** and **sig\_out**.
  - b. Set the Direction field to **input** for `sig_in` and `clk` and to **output** for `sig_out`.

- c. Leave the Bus designation boxes unchecked.

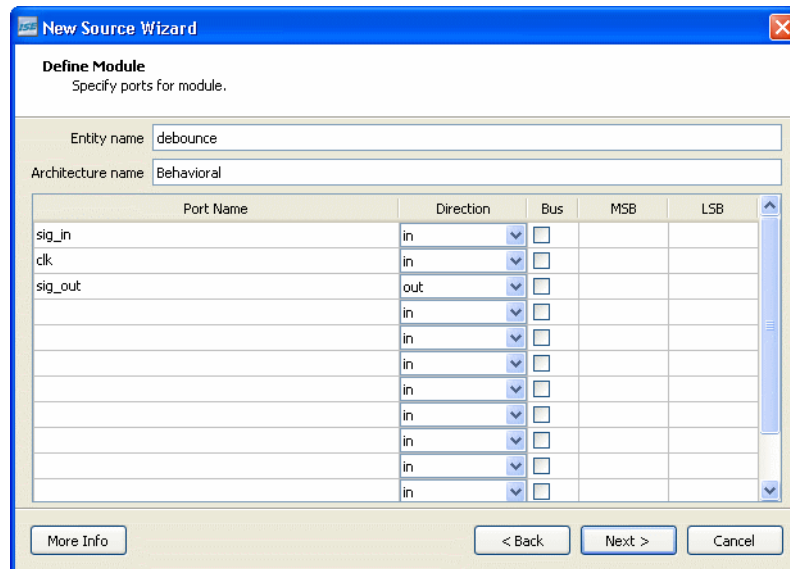

Figure 3-6: New Source Wizard—Define Module Page

6. Click **Next** to view a description of the module.
7. Click **Finish** to open the empty HDL file in the ISE Text Editor.

Following is an example VHDL file.

```

7  -- Module Name:    debounce - Behavioral
8  -- Project Name:
9  -- Target Devices:
10 -- Tool versions:
11 -- Description:
12 --
13 -- Dependencies:
14 --
15 -- Revision:
16 -- Revision 0.01 - File Created
17 -- Additional Comments:
18 --
19 -----
20 library IEEE;
21 use IEEE.STD_LOGIC_1164.ALL;
22 use IEEE.STD_LOGIC_ARITH.ALL;
23 use IEEE.STD_LOGIC_UNSIGNED.ALL;
24
25 ---- Uncomment the following library declaration if instantiating
26 ---- any Xilinx primitives in this code.
27 --library UNISIM;
28 --use UNISIM.VComponents.all;
29
30 entity debounce is
31     Port ( sig_in : in  STD_LOGIC;
32           clk     : in  STD_LOGIC;
33           sig_out : out STD_LOGIC);
34 end debounce;
35
36 architecture Behavioral of debounce is
37
38 begin
39
40
41 end Behavioral;
42

```

Figure 3-7: VHDL File in ISE Text Editor

Following is an example Verilog file.

```

1  `timescale 1ns / 1ps
2  ///////////////////////////////////////////////////////////////////
3  // Company:
4  // Engineer:
5  //
6  // Create Date:    14:12:53 03/15/2007
7  // Design Name:
8  // Module Name:    debounce
9  // Project Name:
10 // Target Devices:
11 // Tool versions:
12 // Description:
13 //
14 // Dependencies:
15 //
16 // Revision:
17 // Revision 0.01 - File Created
18 // Additional Comments:
19 //
20 ///////////////////////////////////////////////////////////////////
21 module debounce(sig_in, clk, sig_out);
22     input sig_in;
23     input clk;
24     output sig_out;
25
26
27 endmodule
28

```

Figure 3-8: Verilog File in ISE Text Editor

In the ISE Text Editor, the ports are already declared in the HDL file, and some of the basic file structure is already in place. Keywords are displayed in blue, comments in green, and values are black. The file is color-coded to enhance readability and help you recognize typographical errors.

## Using the Language Templates

The ISE Language Templates include HDL constructs and synthesis templates, which represent commonly used logic components, such as counters, D flip-flops, multiplexers, and primitives. You will use the Debounce Circuit template for this exercise.

**Note:** You can add your own templates to the Language Templates for components or constructs that you use often.

To invoke the Language Templates and select the template for this tutorial, do the following:

1. From Project Navigator, select **Edit > Language Templates**.

Each HDL language in the Language Templates is divided into five sections: Common Constructs, Device Macro Instantiation, Device Primitive Instantiation, Simulation Constructs, Synthesis Constructs and User Templates. To expand the view of any of these sections, click the plus symbol (+) next to the section. Click any of the listed templates to view the template contents in the right pane.

2. Under either the VHDL or Verilog hierarchy, expand **Synthesis Constructs**, expand **Coding Examples**, expand **Misc**, and select the template called **Debounce Circuit** or **One Shot, Debounce Circuit**. Use the appropriate template for the language you are using.

Upon selection, the HDL code for a debounce circuit is displayed in the right pane.

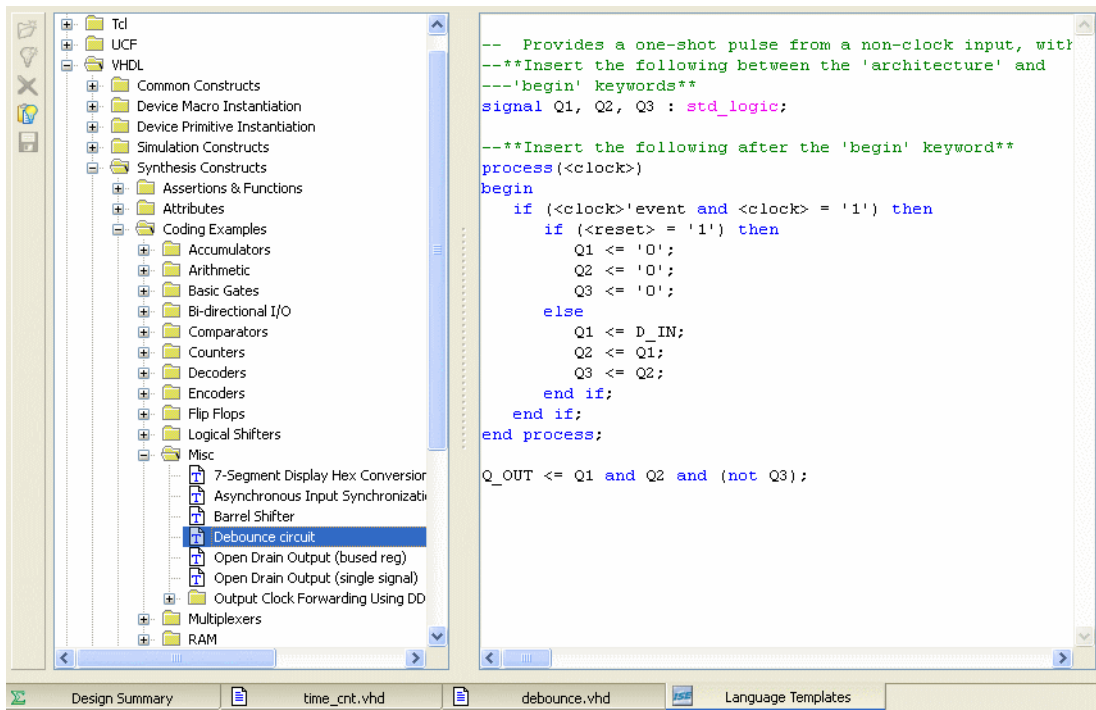

Figure 3-9: Language Templates

### Adding a Language Template to a File

You will now use the “Use in File” method for adding templates to your HDL file. Refer to “Working with Language Templates” in the ISE Help for additional usability options, including drag and drop options.

To add the template to your HDL file, do the following:

1. With the `debounce.v` or `debounce.vhd` source file active, position the cursor under the architecture begin statement in the VHDL file, or under the module and pin declarations in the Verilog file.
2. Return to the Language Templates window, right-click on the **Debounce Circuit** template in the template index, and select **Use In File**.

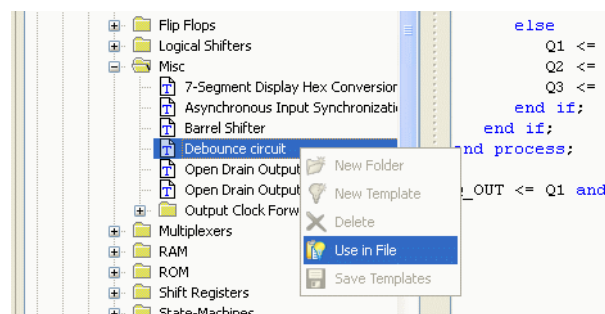

Figure 3-10: Selecting Language Template to Use in File

3. Close the Language Templates window.

4. Open the `debounce.v` or `debounce.vhd` source file to verify that the Language Template was properly inserted.
5. *Verilog only:* Complete the Verilog module by doing the following:
  - a. Remove the reset logic (not used in this design) by deleting the three lines beginning with `if` and ending with `else`.
  - b. Change `<reg_name>` to `q` in all six locations.
  - c. Change `<clock>` to `clk`; `<input>` to `sig_in`; and `<output>` to `sig_out`.  
**Note:** You can select **Edit > Find & Replace** to facilitate this. The Find fields appear at the bottom of the Text Editor.
6. *VHDL only:* Complete the VHDL module by doing the following:
  - a. Move the line beginning with the word `signal` so that it is between the `architecture` and `begin` keywords.
  - b. Remove the reset logic (not used in this design) by deleting the five lines beginning with `if (<reset>...` and ending with `else`, and delete one of the `end if;` lines.
  - c. Change `<clock>` to `clk`; `D_IN` to `sig_in`; and `Q_OUT` to `sig_out`.  
**Note:** You can select **Edit > Find & Replace** to facilitate this. The Find fields appear at the bottom of the Text Editor.
7. Save the file by selecting **File > Save**.
8. Select one of the `debounce` instances in the Hierarchy pane.
9. In the Processes pane, double-click **Check Syntax**. Verify that the syntax check passes successfully. Correct any errors as necessary.
10. Close the ISE Text Editor.

## Creating a CORE Generator Software Module

The CORE Generator software is a graphical interactive design tool that enables you to create high-level modules such as memory elements, math functions and communications, and I/O interface cores. You can customize and pre-optimize the modules to take advantage of the inherent architectural features of the Xilinx FPGA architectures, such as Fast Carry Logic, SRL16s, and distributed and block RAM.

In this section, you will create a CORE Generator software module called `timer_preset`. The module will be used to store a set of 64 values to load into the timer.

### Creating the `timer_preset` CORE Generator Software Module

To create a CORE Generator software module, do the following:

1. In Project Navigator, select **Project > New Source**.
2. Select **IP (CORE Generator & Architecture Wizard)**.
3. In the File Name field, enter `timer_preset`.
4. Click **Next**.
5. Expand the IP tree selector to locate **Memories & Storage Elements > RAMs & ROMs**.



6. Select **Distributed Memory Generator**, click **Next**, and click **Finish** to open the Distributed Memory Generator customization GUI. This customization GUI enables you to customize the memory to the design specifications.

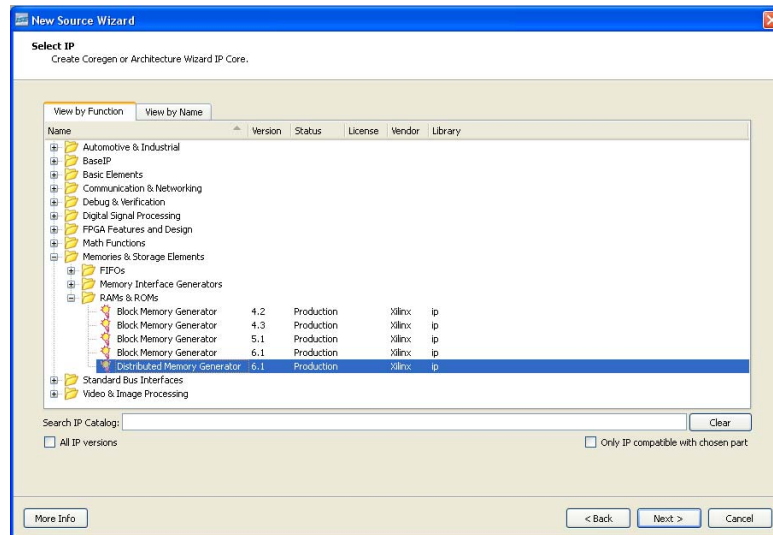

Figure 3-11: New Source Wizard—Select IP Page

7. Fill in the Distributed Memory Generator customization GUI with the following settings:
  - Component Name: **timer\_preset** (defines the name of the module)
  - Depth: **64** (defines the number of values to be stored)
  - Data Width: **20** (defines the width of the output bus)
  - Memory Type: **ROM**

- Click **Next**.

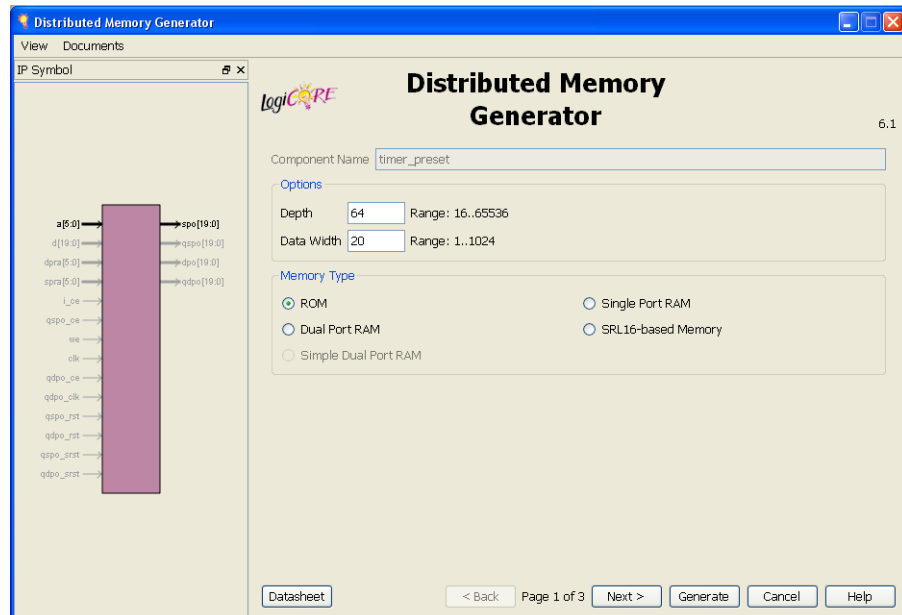

Figure 3-12: CORE Generator Software—Distributed Memory Generator Customization GUI Page 1

- Leave Input and Output options as **Non Registered**, and click **Next**.

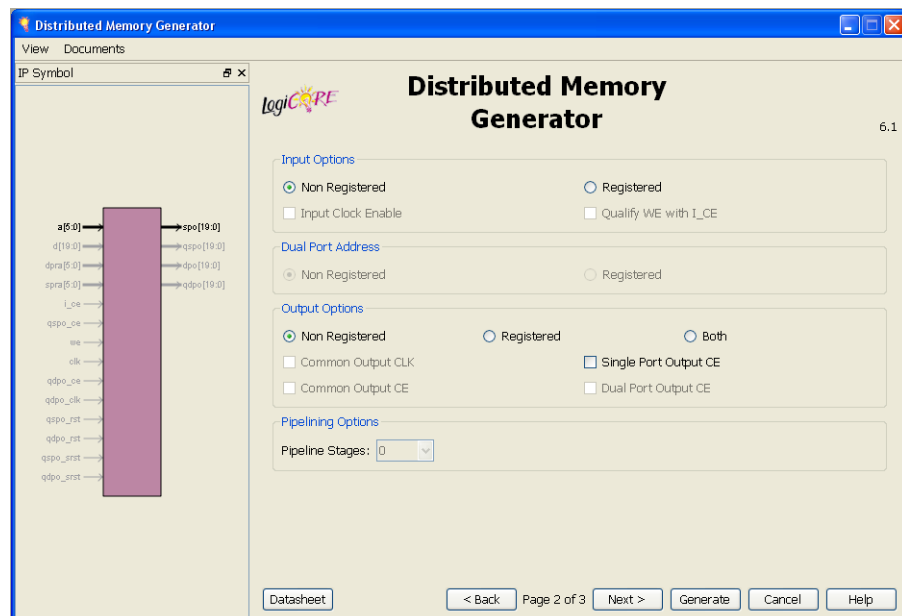

Figure 3-13: CORE Generator Software—Distributed Memory Generator Customization GUI Page 2

10. To specify the Coefficients File, click the **Browse** button, and select `definition1_times.coe` located in the project directory.
11. Check that *only* the following pins are used (used pins are highlighted on the symbol on the left side of the customization GUI):
  - **a[5:0]**
  - **spo[19:0]**
12. Click **Generate**.

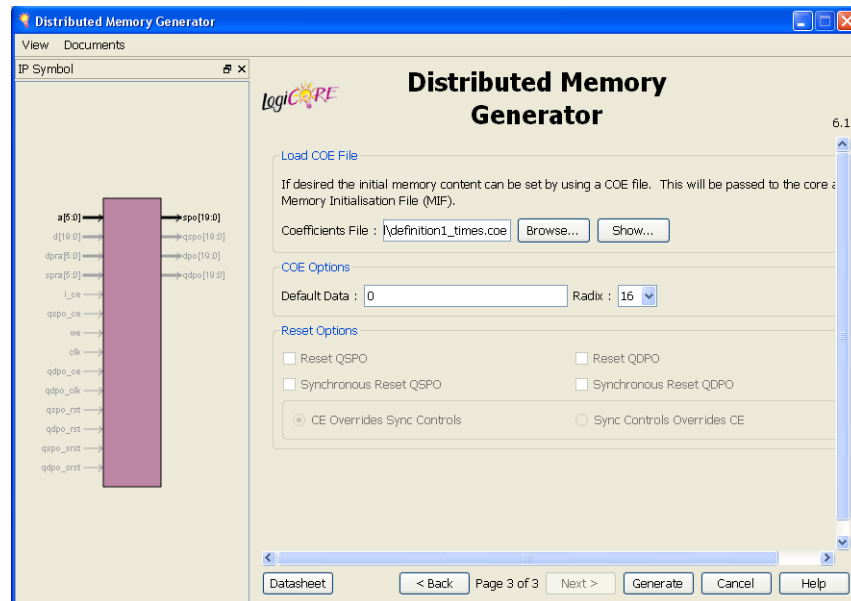

Figure 3-14: CORE Generator Software—Distributed Memory Generator Customization GUI Page 3

The module is created and automatically added to the project library.

A number of files are added to the `ipcore_dir` sub-directory of the project directory. Following is a list of some of these files:

- *timer\_preset.vho* or *timer\_preset.veo*  
These are the instantiation templates used to incorporate the CORE Generator software module into your source HDL.
- *timer\_preset.vhd* or *timer\_preset.v*  
These are HDL wrapper files for the core and are used only for simulation.
- *timer\_preset.ngc*  
This file is the netlist that is used during the Translate phase of implementation.
- *timer\_preset.xco*  
This file stores the configuration information for the `timer_preset` module and is used as the project source in the ISE project.
- *timer\_preset.mif*  
This file provides the initialization values of the ROM for simulation.

## Instantiating the CORE Generator Software Module in the HDL Code

Next, instantiate the CORE Generator software module in the HDL code using either a VHDL flow or a Verilog flow.

### VHDL Flow

To instantiate the CORE Generator software module using a VHDL flow, do the following:

1. In Project Navigator, double-click `stopwatch.vhd` to open the file in ISE Text Editor.
2. Place the cursor after the following line:

```
-- Insert CORE Generator ROM component declaration here
```

3. Select **Edit > Insert File**, then select `ipcore_dir/timer_preset.vho`, and click **Open**.

The VHDL template file for the CORE Generator software instantiation is inserted.

```
121 ----- Begin Cut here for COMPONENT Declaration ----- COMP_TAG
122 component timer_preset
123     port (
124         a: IN std_logic_VECTOR(5 downto 0);
125         spo: OUT std_logic_VECTOR(19 downto 0));
126 end component;
127
128 -- Synplicity black box declaration
129 attribute syn_black_box : boolean;
130 attribute syn_black_box of timer_preset: component is true;
131
132 -- COMP_TAG_END ----- End COMPONENT Declaration -----
```

Figure 3-15: VHDL Component Declaration for CORE Generator Software Module

4. Highlight the inserted code from:

```
-- Begin Cut here for INSTANTIATION Template ----
```

to

```
--INST_TAG_END ----- END INSTANTIATION Template -----
```

5. Select **Edit > Cut**.

6. Place the cursor after the following line:

```
--Insert CORE Generator ROM Instantiation here
```

7. Select **Edit > Paste** to place the core instantiation.

8. Change the instance name from `your_instance_name` to `t_preset`.

9. Edit this instantiated code to connect the signals in the stopwatch design to the ports of the CORE Generator software module as shown below.

```
169 ----- Insert CORE Generator ROM instantiation here
170 ----- Begin Cut here for INSTANTIATION Template ----- INST_TAG
171 t_preset : timer_preset
172     port map (
173         a => address,
174         spo => preset_time);
175 -- INST_TAG_END ----- End INSTANTIATION Template -----
```

Figure 3-16: VHDL Component Instantiation of CORE Generator Software Module

10. The inserted code of `timer_preset.vho` contains several lines of commented text for instruction and legal documentation. Delete these commented lines if desired.

11. Save the design using **File > Save**, and close the ISE Text Editor.

## Verilog Flow

To instantiate the CORE Generator software module using a Verilog flow, do the following:

1. In Project Navigator, double-click `stopwatch.v` to open the file in the ISE Text Editor.
2. Place the cursor after the following line:  

```
//Place the Coregen module instantiation for timer_preset here
```
3. Select **Edit > Insert File**, and select `ipcore_dir/timer_preset.v`.
4. The inserted code of `timer_preset.v` contains several lines of commented text for instruction and legal documentation. Delete these commented lines if desired.
5. Change the instance name from `YourInstanceName` to **t\_preset**.
6. Edit this code to connect the signals in the stopwatch design to the ports of the CORE Generator software module as shown below.

```

36 // Place the Coregen module instantiation for timer_preset here
37 //----- Begin Cut here for INSTANTIATION Template ---// INST_TAG
38 timer_preset t_preset (
39     .a(address), // Bus [5 : 0]
40     .spo(preset_time); // Bus [19 : 0]
41
42 // INST_TAG_END ----- End INSTANTIATION Template -----

```

Figure 3-17: Verilog Component Instantiation of the CORE Generator Software Module

7. Save the design using **File > Save** and close the ISE Text Editor.

The core module should now appear beneath the stopwatch module in the hierarchy.

## Creating a DCM Module

The Clocking Wizard, a part of the Xilinx Architecture Wizard, enables you to graphically select Digital Clock Manager (DCM) features that you want to use. In this section you will create a basic DCM module with CLK0 feedback and duty-cycle correction.

### Using the Clocking Wizard

To create the `dcm1` module, do the following:

1. In Project Navigator, select **Project > New Source**.
2. In the New Source Wizard, select **IP (CoreGen & Architecture Wizard)** source and enter `dcm1` for the file name.
3. Click **Next**.

4. In the Select IP dialog box, select **FPGA Features and Design > Clocking > Spartan-3E, Spartan-3A > Single DCM\_SP**.

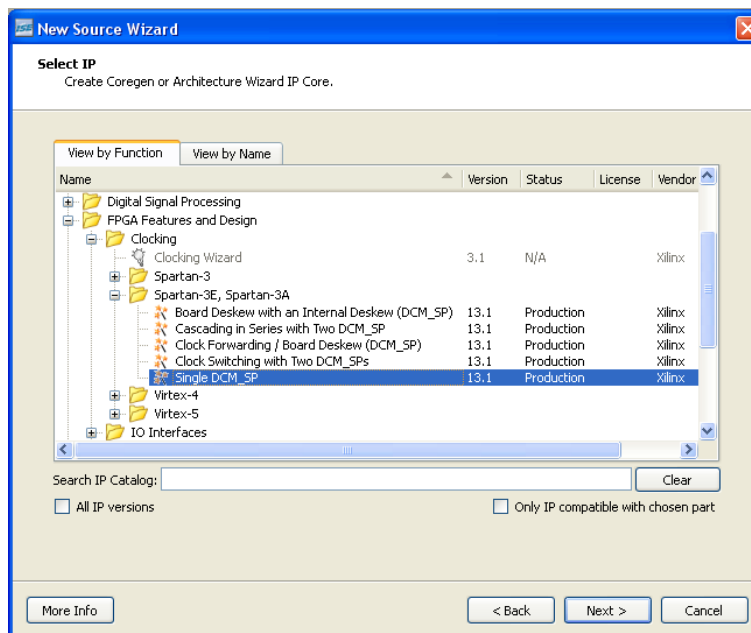

Figure 3-18: Selecting Single DCM\_SP IP Type

5. Click **Next**, and click **Finish**. The Clocking Wizard is launched.
6. In the Architecture Wizard Setup page, select **OK**.
7. In the General Setup page, verify that **RST**, **CLK0** and **LOCKED** ports are selected.
8. Select **CLKFX** port.
9. Enter **50** and select **MHz** for the Input Clock Frequency.
10. Verify the following settings:
  - Phase Shift: **NONE**
  - CLKIN Source: **External, Single**
  - Feedback Source: **Internal**
  - Feedback Value: **1X**
  - Use Duty Cycle Correction: Selected
11. Click the **Advanced** button.
12. Select **Wait for DCM lock before DONE Signal goes high**.
13. Click **OK**.
14. Click **Next**, and then click **Next** again.
15. Select **Use output frequency** and enter **26.2144** in the box and select **MHz**.

$$(26.2144\text{MHz}) / 2^{18} = 100\text{Hz}$$

16. Click **Next**, and then click **Finish**.

The dcm1 .xaw file is added to the list of project source files in the Hierarchy pane of the Design panel.

## Instantiating the dcm1 Macro—VHDL Design

Next, you will instantiate the dcm1 macro for your VHDL or Verilog design. To instantiate the dcm1 macro for the VHDL design, do the following:

1. In the Hierarchy pane of the Project Navigator Design panel, select `dcm1 .xaw`.
2. In the Processes pane, right-click **View HDL Instantiation Template**, and select **Process Properties**.
3. Choose **VHDL** for the HDL Instantiation Template Target Language value, and click **OK**.
4. In the Processes pane, double-click **View HDL Instantiation Template**.
5. Highlight the component declaration template in the newly opened HDL Instantiation Template (`dcm1 .vhi`) shown below.

```

4  -- Notes:
5  -- 1) This instantiation template has been auto
6  -- std_logic and std_logic_vector for the ports
7  -- 2) To use this template to instantiate this
8
9  COMPONENT dcm1
10 PORT(
11     CLKIN_IN : IN std_logic;
12     RST_IN : IN std_logic;
13     CLKFX_OUT : OUT std_logic;
14     CLKIN_IBUFG_OUT : OUT std_logic;
15     CLKO_OUT : OUT std_logic;
16     LOCKED_OUT : OUT std_logic
17 );
18 END COMPONENT;
```

Figure 3-19: VHDL DCM Component Declaration

6. Select **Edit > Copy**.
7. Place the cursor in the following section of the `stopwatch.vhd` file:  
-- Insert dcm1 component declaration here.
8. Select **Edit > Paste** to paste the component declaration.
9. Highlight the instantiation template in the newly opened HDL Instantiation Template shown below.

```

19
20     Inst_dcm1: dcm1 PORT MAP (
21         CLKIN_IN => ,
22         RST_IN => ,
23         CLKFX_OUT => ,
24         CLKIN_IBUFG_OUT => ,
25         CLKO_OUT => ,
26         LOCKED_OUT =>
27     );
28
```

Figure 3-20: VHDL DCM Component Instantiation

10. Select **Edit > Copy**.
11. Place the cursor below the following line in the `stopwatch.vhd` file:  
-- Insert dcm1 instantiation here.
12. Select **Edit > Paste** to paste the instantiation template.

13. Make the necessary changes as shown in the following figure.

```

141 ----- Insert dcm1 instantiation here
142     Inst_dcm1: dcm1 PORT MAP(
143         CLKIN_IN => clk,
144         RST_IN => reset,
145         CLKFX_OUT => clk_26214k,
146         CLKIN_IBUFG_OUT => open,
147         CLKO_OUT => open,
148         LOCKED_OUT => locked
149     );

```

Figure 3-21: VHDL Instantiation for dcm1

14. Select **File > Save** to save the stopwatch.vhd file.

The dcm1 module should now appear beneath the stopwatch module in the design hierarchy.

### Instantiating the dcm1 Macro—Verilog

To instantiate the dcm1 macro for your Verilog design, do the following:

1. In the Hierarchy pane of the Project Navigator Design panel, select dcm1.xaw.
2. In the Processes pane, double-click **View HDL Instantiation Template**.
3. From the newly opened HDL Instantiation Template (dcm1.tfi), copy the instantiation template shown below.

```

4 // Instantiate the module
5 dcm1 instance_name (
6     .CLKIN_IN(CLKIN_IN),
7     .RST_IN(RST_IN),
8     .CLKFX_OUT(CLKFX_OUT),
9     .CLKIN_IBUFG_OUT(CLKIN_IBUFG_OUT),
10    .CLKO_OUT(CLKO_OUT),
11    .LOCKED_OUT(LOCKED_OUT)
12 );

```

Figure 3-22: dcm1 Macro and Instantiation Templates

4. Paste the instantiation template into the following section in the stopwatch.v file:  
//Insert dcm1 instantiation here.
5. Make the necessary changes as shown in the following figure.

```

82
83 //Insert dcm1 instantiation here
84
85 dcm1 inst_dcm1 (
86     .CLKIN_IN(clk),
87     .RST_IN(reset),
88     .CLKFX_OUT(clk_26214k),
89     .CLKIN_IBUFG_OUT(),
90     .CLKO_OUT(),
91     .LOCKED_OUT(locked)
92 );

```

Figure 3-23: Verilog Instantiation for dcm1

6. Select **File > Save** to save the stopwatch.v file.

The dcm1 module should now appear beneath the stopwatch module in the design hierarchy.



## Synthesizing the Design

So far you have been using Xilinx Synthesis Technology (XST) for syntax checking. Next, you will synthesize the design using either XST, Synplify/Synplify Pro, or Precision software. The synthesis tool uses the design's HDL code and generates a supported netlist type (EDIF or NGC) for the Xilinx implementation tools. The synthesis tool performs the following general steps (although all synthesis tools further break down these general steps) to create the netlist:

- **Analyze/Check Syntax**  
Checks the syntax of the source code.
- **Compile**  
Translates and optimizes the HDL code into a set of components that the synthesis tool can recognize.
- **Map**  
Translates the components from the compile stage into the target technology's primitive components.

The synthesis tool can be changed at any time during the design flow. To change the synthesis tool, do the following:

1. In the Hierarchy pane of the Project Navigator Design panel, select the targeted part.
2. Right-click and select **Design Properties**.
3. In the Design Properties dialog box, click the Synthesis Tool value and use the pull-down arrow to select the desired synthesis tool from the list.

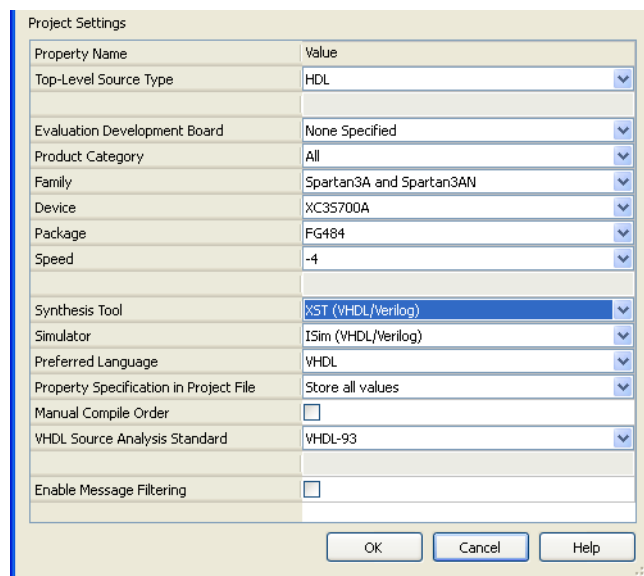

Figure 3-24: Specifying Synthesis Tool

**Note:** If you do not see your synthesis tool among the options in the list, you may not have the software installed or may not have it configured in the ISE software. The synthesis tools are configured in the Preferences dialog box. Select **Edit > Preferences**, expand **ISE General**, and click **Integrated Tools**.

Changing the design flow results in the deletion of implementation data. You have not yet created any implementation data in this tutorial. For projects that contain implementation

data, Xilinx recommends that you make a copy of the project using **File > Copy Project** if you would like to make a backup of the project before continuing.

## Synthesizing the Design Using XST

Now that you have created and analyzed the design, the next step is to synthesize the design. During synthesis, the HDL files are translated into gates and optimized for the target architecture.

Processes available for synthesis using XST are as follows:

- **View RTL Schematic**  
Generates a schematic view of your RTL netlist.
- **View Technology Schematic**  
Generates a schematic view of your technology netlist.
- **Check Syntax**  
Verifies that the HDL code is entered properly.
- **Generate Post-Synthesis Simulation Model**  
Creates HDL simulation models based on the synthesis netlist.

## Entering Synthesis Options

Synthesis options enable you to modify the behavior of the synthesis tool to make optimizations according to the needs of the design. One commonly used option is to control synthesis to make optimizations based on area or speed. Other options include controlling the maximum fanout of a flip-flop output or setting the desired frequency of the design.

To enter synthesis options, do the following:

1. In the Hierarchy pane of the Project Navigator Design panel, select `stopwatch.vhd` (or `stopwatch.v`).
2. In the Processes pane, right-click the **Synthesize** process, and select **Process Properties**.
3. Under the Synthesis Options tab, set the Netlist Hierarchy property to a value of **Rebuilt**.  
**Note:** To use this property, you must set the Property display level to **Advanced**.
4. Click **OK**.

## Synthesizing the Design

Now you are ready to synthesize your design. To take the HDL code and generate a compatible netlist, do the following:

1. In the Hierarchy pane, select `stopwatch.vhd` (or `stopwatch.v`).
2. In the Processes pane, double-click the **Synthesize** process.

## Using the RTL/Technology Viewer

XST can generate a schematic representation of the HDL code that you have entered. A schematic view of the code helps you analyze your design by displaying a graphical connection between the various components that XST has inferred. Following are the two forms of schematic representation:

- **RTL View**  
Pre-optimization of the HDL code.
- **Technology View**  
Post-synthesis view of the HDL design mapped to the target technology.

To view a schematic representation of your HDL code, do the following:

1. In the Processes pane, expand **Synthesize**, and double-click **View RTL Schematic** or **View Technology Schematic**.
2. If the Set RTL/Technology Viewer Startup Mode dialog appears, select **Start with the Explorer Wizard**.
3. In the Create RTL Schematic start page, select the **clk\_divider** and **lap\_load\_debounce** components from the Available Elements list, and then click the **Add** button to move the selected items to the Selected Elements list.
4. Click **Create Schematic**.

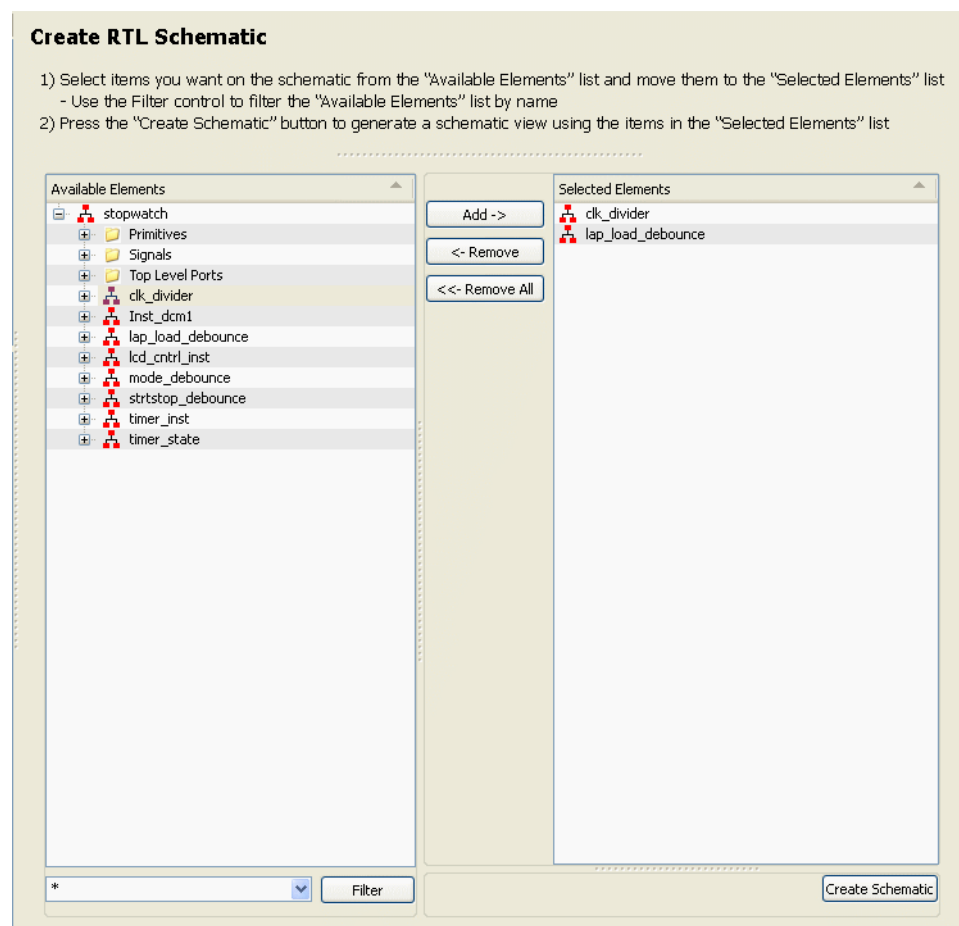

Figure 3-25: Create RTL Schematic Start Page

The RTL Viewer allows you to select the portions of the design to display as schematic. When the schematic is displayed, double-click on the symbol to push into the schematic and view the various design elements and connectivity. Right-click the schematic to view the various operations that can be performed in the schematic viewer.

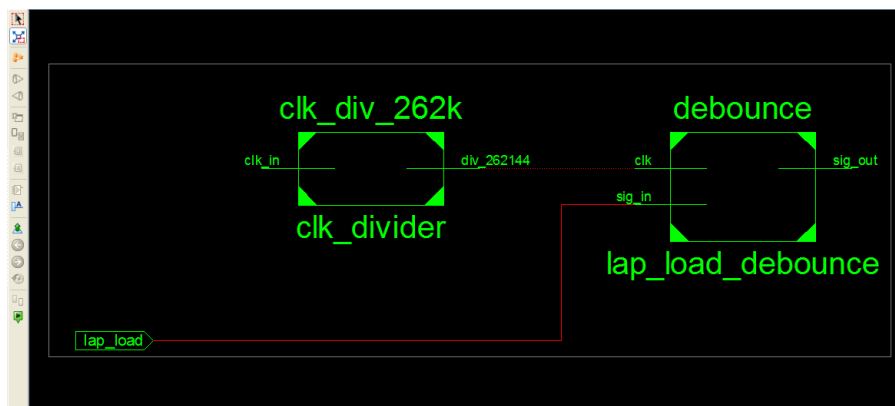

Figure 3-26: RTL Schematic

You have completed XST synthesis. An NGC file now exists for the stopwatch design.

To continue with the HDL flow, do either of the following:

- Go to [Chapter 5, Behavioral Simulation](#), to perform a pre-synthesis simulation of this design.
- Proceed to [Chapter 6, Design Implementation](#), to place and route the design.

**Note:** For more information about XST constraints, options, reports, or running XST from the command line, see the *XST User Guides*. These guides are available from the ISE Software Manuals collection, automatically installed with your ISE software. To open the Software Manuals collection, select **Help > Software Manuals**. The [Software Manuals](#) collection is also available from the Xilinx website.

## Synthesizing the Design Using Synplify/Synplify Pro Software

Now that you have entered and analyzed the design, the next step is to synthesize the design. In this step, the HDL files are translated into gates and optimized to the target architecture. To access the Synplify software RTL viewer and constraints editor you must run the Synplify software outside of the ISE software.

Processes available for synthesis using the Synplify and Synplify Pro software are as follows:

- **View Synthesis Report**  
Lists the synthesis optimizations that were performed on the design and gives a brief timing and mapping report.
- **View RTL Schematic**  
Accessible from the Launch Tools hierarchy, this process displays the Synplify or Synplify Pro software with a schematic view of your HDL code.
- **View Technology Schematic**  
Accessible from the Launch Tools hierarchy, this process displays the Synplify or Synplify Pro software with a schematic view of your HDL code mapped to the primitives associated with the target technology.

## Entering Synthesis Options and Synthesizing the Design

To synthesize the design, set the global synthesis options as follows:

1. In the Hierarchy pane of the Project Navigator Design panel, select `stopwatch.vhd` (or `stopwatch.v`).
2. In the Processes pane, right-click **Synthesize**, and select **Process Properties**.
3. In the Synthesis Options dialog box, select the **Write Vendor Constraint File** box.
4. Click **OK** to accept these values.
5. Double-click the **Synthesize** process to run synthesis.

**Note:** This step can also be done by selecting `stopwatch.vhd` (or `stopwatch.v`), clicking **Synthesize** in the Processes pane, and selecting **Process > Run**.

## Examining Synthesis Results

To view overall synthesis results, double-click **View Synthesis Report** under the **Synthesize** process. The report consists of the following sections:

- [Compiler Report](#)
- [Mapper Report](#)
- [Timing Report](#)
- [Resource Utilization](#)

### Compiler Report

The compiler report lists each HDL file that was compiled, names which file is the top level, and displays the syntax checking result for each file that was compiled. The report also lists FSM extractions, inferred memory, warnings on latches, unused ports, and removal of redundant logic.

**Note:** Black boxes (modules not read into a design environment) are always noted as unbound in the Synplify reports. As long as the underlying netlist (`.ngo`, `.ngc` or `.edn`) for a black box exists in the project directory, the implementation tools merge the netlist into the design during the Translate phase.

### Mapper Report

The mapper report lists the constraint files used, the target technology, and attributes set in the design. The report lists the mapping results of flattened instances, extracted counters, optimized flip-flops, clock and buffered nets that were created, and how FSMs were coded.

### Timing Report

The timing report section provides detailed information on the constraints that you entered and on delays on parts of the design that had no constraints. The delay values are based on wireload models and are considered preliminary. Consult the post-Place and

Route timing reports discussed in [Chapter 6, Design Implementation](#), for the most accurate delay information.

```
Performance Summary
*****

Worst slack in design: -1.581
```

Starting Clock	Requested Frequency	Estimated Frequency	Requested Period	Estimated Period	Slack
stopwatch clk_divider.clk_100_inferred_clock	305.3 MHz	259.5 MHz	3.276	3.854	-0.578
stopwatch dcm1_inst.CLKFX_BUF_derived_clock	111.6 MHz	94.9 MHz	8.959	10.540	-1.581

Figure 3-27: Synplify Estimated Timing Data

### Resource Utilization

This section of the report lists all of the resources that the Synplify software uses for the given target technology.

You have now completed Synplify synthesis. At this point, a netlist EDN file exists for the stopwatch design.

To continue with the HDL flow, do either of the following:

- Go to [Chapter 5, Behavioral Simulation](#), to perform a pre-synthesis simulation of this design.
- Proceed to [Chapter 6, Design Implementation](#), to place and route the design.

## Synthesizing the Design Using Precision Synthesis

Now that you have entered and analyzed the design, the next step is to synthesize the design. In this step, the HDL files are translated into gates and optimized to the target architecture.

Processes available for synthesis using the Precision software are as follows:

- **Check Syntax**  
Checks the syntax of the HDL code.
- **View Log File**  
Lists the synthesis optimizations that were performed on the design and gives a brief timing and mapping report.
- **View RTL Schematic**  
Accessible from the Launch Tools hierarchy, this process displays the Precision software with a schematic view of your HDL code.
- **View Technology Schematic**  
Accessible from the Launch Tools hierarchy, this process displays the Precision software with a schematic view of your HDL code mapped to the primitives associated with the target technology.
- **View Critical Path Schematic**  
Accessible from the Launch Tools hierarchy, this process displays the Precision software with a schematic view of the critical path of your HDL code mapped to the primitives associated with the target technology.

## Entering Synthesis Options and Synthesizing the Design

Synthesis options enable you to modify the behavior of the synthesis tool to optimize according to the needs of the design. For the tutorial, the default property settings will be used.

To synthesize the design, do the following:

1. In the Hierarchy pane of the Project Navigator Design panel, select `stopwatch.vhd` (or `stopwatch.v`).
2. In the Processes pane, double-click the **Synthesize** process.

## Using the RTL/Technology Viewer

Precision Synthesis can generate a schematic representation of the HDL code that you have entered. A schematic view of the code helps you analyze your design by seeing a graphical connection between the various components that Precision has inferred. To launch the design in the RTL viewer, double-click the **View RTL Schematic** process. The following figure displays the design in an RTL view.

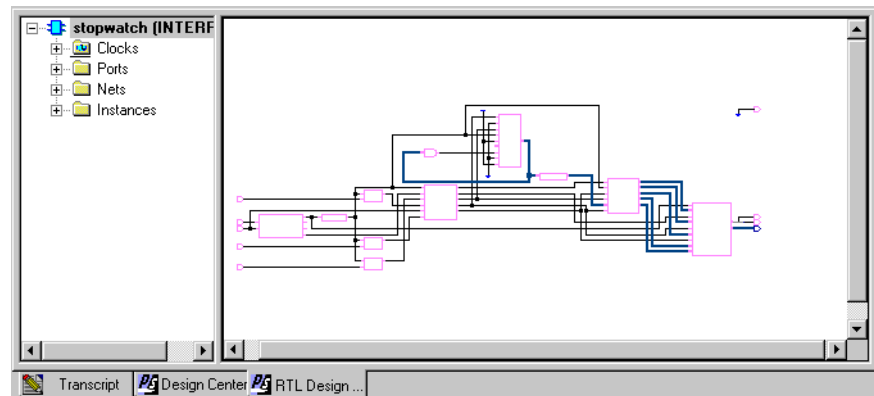

Figure 3-28: Stopwatch Design in Precision Synthesis RTL Viewer

You have now completed the design synthesis. At this point, an EDN netlist file exists for the stopwatch design.

To continue with the HDL flow, do either of the following:

- Go to [Chapter 5, Behavioral Simulation](#), to perform a pre-synthesis simulation of this design.
- Proceed to [Chapter 6, Design Implementation](#), to place and route the design.





# Schematic-Based Design

---

## Overview of Schematic-Based Design

This chapter guides you through a typical FPGA schematic-based design procedure using the design of a runner's stopwatch. The design example used in this tutorial demonstrates many device features, software features, and design flow practices that you can apply to your own designs. The stopwatch design targets a Spartan™-3A device; however, all of the principles and flows taught are applicable to any Xilinx® device family, unless otherwise noted.

This chapter is the first in the [Schematic Design Flow](#). In the first part of the tutorial, you will use the ISE® design entry tools to complete the design. The design is composed of schematic elements, CORE Generator™ software components, and HDL macros. After the design is successfully entered in the Schematic Editor, you will perform behavioral simulation ([Chapter 5, Behavioral Simulation](#)), run implementation with the Xilinx implementation tools ([Chapter 6, Design Implementation](#)), perform timing simulation ([Chapter 7, Timing Simulation](#)), and configure and download to the Spartan-3A (XC3S700A) demo board (see [Chapter 8, Configuration Using iMPACT](#)).

## Getting Started

The following sections describe the basic requirements for running the tutorial.

### Required Software

To perform this tutorial, you must have Xilinx ISE Design Suite installed. For this design, you must install the Spartan-3A device libraries and device files.

This tutorial assumes that the software is installed in the default location, at `c:\xilinx\release_number\ISE_DS\ISE`. If you installed the software in a different location, substitute your installation path in the procedures that follow.

**Note:** For detailed software installation instructions, refer to the [ISE Design Suite: Installation and Licensing Guide \(UG798\)](#) available from the Xilinx website.

## Installing the Tutorial Project Files

The tutorial project files are provided with the ISE Design Suite [Tutorials](#) available from the Xilinx website. Download the schematic design files (`wtut_sc.zip`). The download contains the following directories:

- `wtut_sc`  
Contains source files for the schematic tutorial. The schematic tutorial project will be created in this directory.
- `wtut_sc\wtut_sc_completed`  
Contains the completed design files for the schematic tutorial design, including schematic, HDL, and state machine files.

**Note:** Do not overwrite files under this directory.

The schematic tutorial files are copied into the directories when you unzip the files. This tutorial assumes that the files are unzipped under `c:\xilinx_tutorial`, but you can unzip the source files into any directory with read/write permissions. If you unzip the files into a different location, substitute your project path in the procedures that follow.

## Starting the ISE Software

To launch the ISE software, double-click the ISE Project Navigator icon on your desktop, or select **Start > All Programs > Xilinx ISE Design Suite > ISE Design Tools > Project Navigator**.



Figure 4-1: Project Navigator Desktop Icon

## Creating a New Project

To create a new project using the New Project Wizard, do the following:

1. From Project Navigator, select **File > New Project**.
2. In the Location field, browse to `c:\xilinx_tutorial` or to the directory in which you installed the project.
3. In the Name field, enter `wtut_sc`.
4. Select **Schematic** as the Top-Level Source Type, and then click **Next**.
5. Select the following values in the New Project Wizard—Device Properties page:
  - Product Category: **All**
  - Family: **Spartan3A and Spartan3AN**
  - Device: **XC3S700A**

- Package: **FG484**
- Speed: **-4**
- Synthesis Tool: **XST (VHDL/Verilog)**
- Simulator: **ISim (VHDL/Verilog)**
- Preferred Language: **VHDL** or **Verilog** depending on preference. This will determine the default language for all processes that generate HDL files.

Other properties can be left at their default values.

6. Click **Next**, then **Finish** to complete the project creation.

## Stopping the Tutorial

If you need to stop the tutorial at any time, save your work by selecting **File > Save All**.

## Design Description

The design used in this tutorial is a hierarchical, schematic-based design, which means that the top-level design file is a schematic sheet that refers to several other lower-level macros. The lower-level macros are a variety of different types of modules, including schematic-based modules, a CORE Generator software module, an Architecture Wizard module, and HDL modules.

The runner's stopwatch design begins as an unfinished design. Throughout the tutorial, you will complete the design by creating some of the modules and by completing others from existing files. Through the course of this chapter, you will create these modules,

instantiate them, and then connect them. The following figure shows a schematic of the completed stopwatch design.

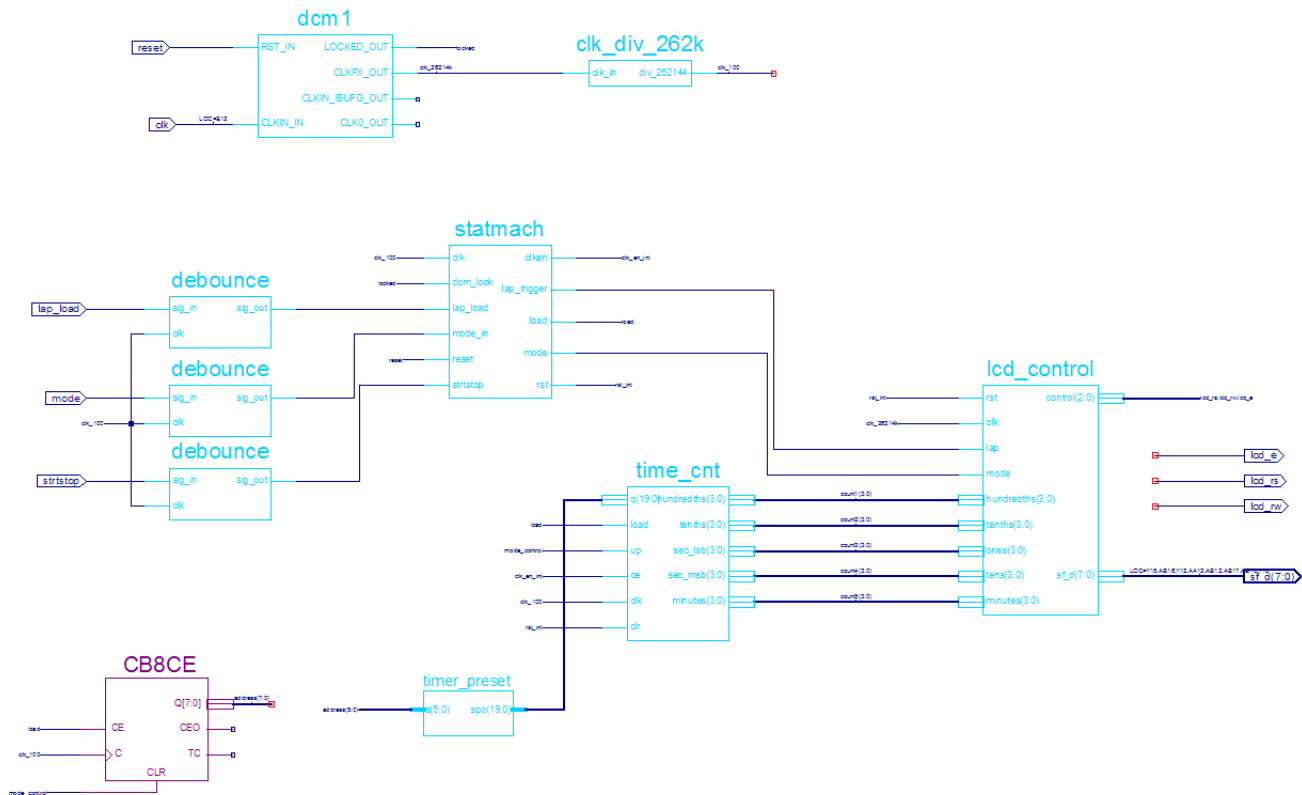

Figure 4-2: Completed Stopwatch Schematic

After the design is complete, you will simulate the design to verify its functionality. For more information about simulating your design, see [Chapter 5, Behavioral Simulation](#).

There are five external inputs and four external outputs in the completed design. The following sections summarize the inputs and outputs, and their respective functions.

## Inputs

The following are input signals for the tutorial stopwatch design:

- strtstop**  
 Starts and stops the stopwatch. This is an active low signal which acts like the start/stop button on a runner's stopwatch.
- reset**  
 Puts the stopwatch in clocking mode and resets the time to 0:00:00.
- clk**  
 Externally generated system clock.
- mode**  
 Toggles between clocking and timer modes. This input is only functional while the clock or timer is not counting.

- **lap\_load**  
This is a dual function signal. In clocking mode it displays the current clock value in the 'Lap' display area. In timer mode it will load the pre-assigned values from the ROM to the timer display when the timer is not counting.

## Outputs

The following are outputs signals for the design:

- **lcd\_e, lcd\_rs, lcd\_rw**  
These outputs are the control signals for the LCD display of the Spartan-3A demo board used to display the stopwatch times.
- **sf\_d[7:0]**  
Provides the data values for the LCD display.

## Functional Blocks

The completed design consists of the following functional blocks. Most of these blocks do not appear on the schematic sheet in the project until after you create and add them to the schematic during this tutorial.

The completed design consists of the following functional blocks:

- **clk\_div\_262k**  
Macro which divides a clock frequency by 262,144. Converts 26.2144 MHz clock into 100 Hz 50% duty cycle clock.
- **dcm1**  
Clocking Wizard macro with internal feedback, frequency controlled output, and duty-cycle correction. The CLKFX\_OUT output converts the 50 MHz clock of the Spartan-3A demo board to 26.2144 MHz.
- **debounce**  
Module implementing a simplistic debounce circuit for the strtstop, mode, and lap\_load input signals.
- **lcd\_control**  
Module controlling the initialization of and output to the LCD display.
- **statmach**  
State machine module which controls the state of the stopwatch.
- **timer\_preset**  
CORE Generator software 64X20 ROM. This macro contains 64 preset times from 0:00:00 to 9:59:99 which can be loaded into the timer.
- **time\_cnt**  
Up/down counter module which counts between 0:00:00 to 9:59:99 decimal. This macro has five 4-bit outputs, which represent the digits of the stopwatch time.

## Design Entry

In this hierarchical design, you will create various types of macros, including schematic-based macros, HDL-based macros, and CORE Generator software macros. You will learn the process for creating each of these types of macros, and you will connect the macros together to create the completed stopwatch design. All procedures used in the tutorial can be used later for your own designs.

### Adding Source Files

Source files must be added to the project before the design can be edited, synthesized and implemented. You will add six source files to the project as follows:

1. Select **Project > Add Source**.
2. Select the following files from the project directory and click **Open**.
  - cd4rled.sch
  - ch4rled.sch
  - clk\_div\_262k.vhd
  - lcd\_control.vhd
  - stopwatch.sch
  - statmach.vhd
3. In the Adding Source Files dialog box, verify that the files are associated with **All**, that the associated library is **work**, and click **OK**.

The Hierarchy pane in the Design panel displays all of the source files currently added to the project, with the associated entity or module names.

### Opening the Schematic File in the Xilinx Schematic Editor

The stopwatch schematic available in the `wtut_sc` project is incomplete. In this tutorial, you will update the schematic in the Schematic Editor. After you create the project in the ISE software and add the source files, you can open the `stopwatch.sch` file for editing. To open the schematic file, double-click `stopwatch.sch` in the Hierarchy pane of the Design panel.

The stopwatch schematic diagram opens in the Project Navigator Workspace. You will see the unfinished design with elements in the lower right corner, as shown in the following figure.

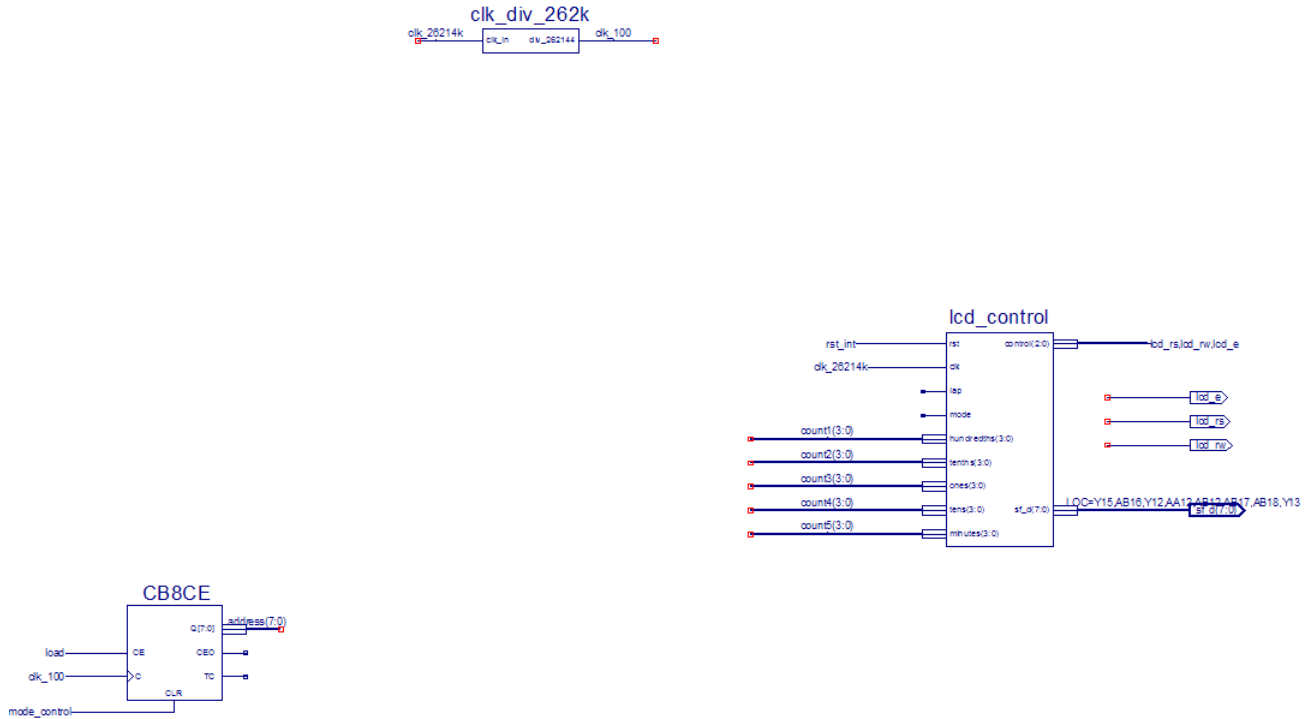

Figure 4-3: Incomplete Stopwatch Schematic

## Manipulating the Window View

The View menu commands enable you to manipulate how the schematic is displayed. Select **View > Zoom > In** until you can comfortably view the schematic.

The schematic window can be undocked from the Project Navigator framework by selecting **Window > Float** while the schematic is selected in the Workspace.

After being undocked, the schematic window can be redocked by selecting **Window > Dock**.

## Creating a Schematic-Based Macro

A schematic-based macro consists of a symbol and an underlying schematic. You can create either the underlying schematic or the symbol first. The corresponding symbol or schematic file can then be generated automatically.

In the following steps, you will create a schematic-based macro by using the New Source Wizard in Project Navigator. An empty schematic file is then created, and you can define the appropriate logic. The created macro is then automatically added to the project library.

The macro you will create is called `time_cnt`. This macro is a binary counter with five, 4-bit outputs, representing the digits of the stopwatch.

To create a schematic-based macro, do the following:

1. In Project Navigator, select **Project > New Source**.

The New Source Wizard opens, which displays a list of all of the available source types.

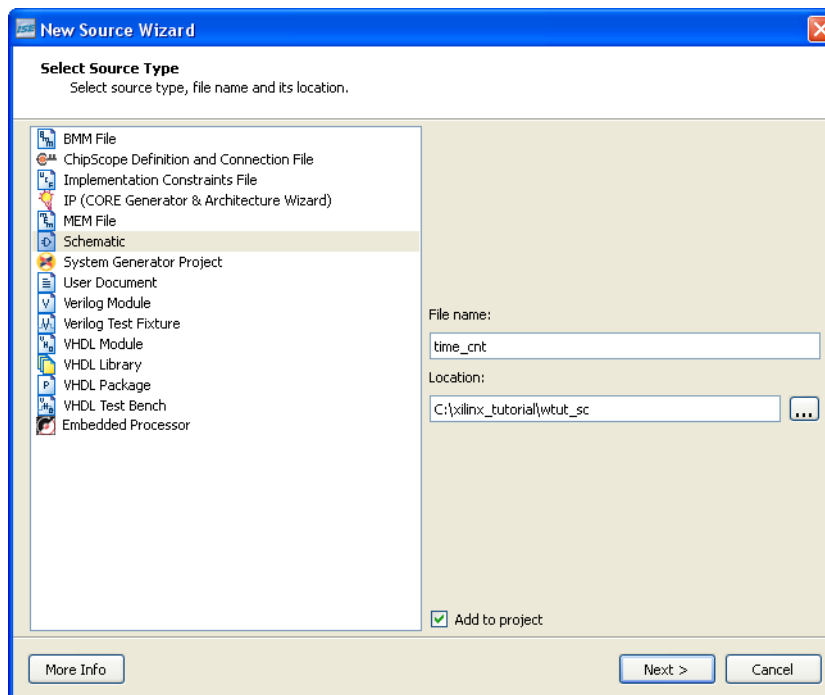

Figure 4-4: New Source Dialog Box

2. Select **Schematic** as the source type.
3. In the File name field, enter `time_cnt`.
4. Click **Next**, and click **Finish**.

A new schematic called `time_cnt.sch` is created, added to the project, and opened for editing.

5. Change the size of the schematic sheet by doing the following:
  - Right-click on the schematic page and select **Object Properties**.
  - Click on the down arrow next to the sheet size value and select **D = 34 x 22**.
  - Click **OK**, and then click **Yes** to acknowledge that changing the sheet size cannot be undone with the **Edit > Undo** option.

## Defining the `time_cnt` Schematic

You have now created an empty schematic for `time_cnt`. The next step is to add the components that make up the `time_cnt` macro. You can then reference this macro symbol by placing it on a schematic sheet.



## Adding I/O Markers

I/O markers are used to determine the ports on a macro or the top-level schematic. The name of each pin on the symbol must have a corresponding connector in the underlying schematic. Add I/O markers to the time\_cnt schematic to determine the macro ports.

To add the I/O markers, do the following:

1. Select **Tools > Create I/O Markers**.  
The Create I/O Markers dialog box opens.
2. In the Inputs field, enter **q(19:0),load,up,ce,clk,clr**.
3. In the Outputs box, enter **hundredths(3:0),tenths(3:0),sec\_lsb(3:0),sec\_msb(3:0),minutes(3:0)**.

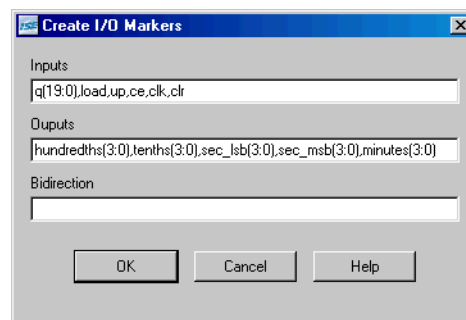

Figure 4-5: Create I/O Markers Dialog Box

4. Click **OK**.

The eleven I/O markers are added to the schematic sheet.

**Note:** The Create I/O Marker function is available only for an empty schematic sheet. However, I/O markers can be added to nets at any time by selecting **Add > I/O Marker** and selecting the desired net.

## Adding Schematic Components

Components from the device and project libraries for the given project are available from the Symbol Browser, and the component symbol can be placed on the schematic. The available components listed in the Symbol Browser are arranged alphabetically within each library.

To add schematic components, do the following:

1. Select **Add > Symbol**, or click the Add Symbol toolbar button.



Figure 4-6: Add Symbol Toolbar Button

The Symbol Browser appears in the Options panel to the left of the schematic. The Symbol Browser displays the libraries and their corresponding components.

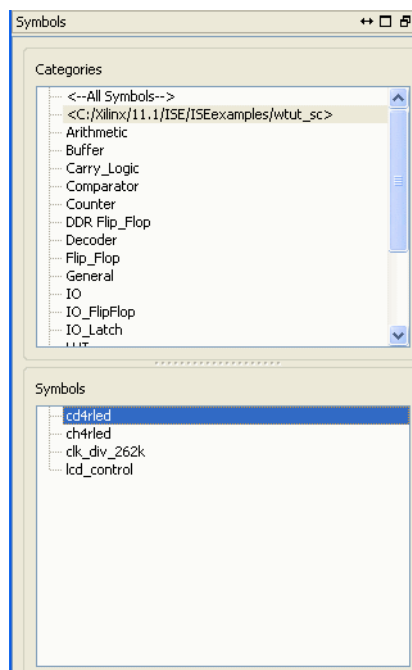

Figure 4-7: Symbol Browser

**Note:** The Options panel changes depending on the action you are performing in the schematic.

2. The first component you will place is a `cd4rled`, a 4-bit, loadable, bi-directional, BCD counter with clock enable and synchronous clear. Select the `cd4rled` component, using either of the following methods:
  - Highlight the project directory category from the Symbol Browser dialog box and select the component **cd4rled** from the symbols list.
  - Select **All Symbols** and enter **cd4rled** in the Symbol Name Filter at the bottom of the Symbol Browser.
3. Move the mouse back into the schematic window.  
You will notice that the cursor has changed to represent the `cd4rled` symbol.
4. Move the symbol outline near the top and center of the sheet and click the left mouse button to place the object.

**Note:** You can rotate new components being added to a schematic by selecting **Ctrl+R**. You can rotate existing components by selecting the component, and then selecting **Ctrl+R**.

- Place three more cd4rled symbols on the schematic by moving the cursor with attached symbol outline to the desired location and clicking the left mouse button. See the following figure.

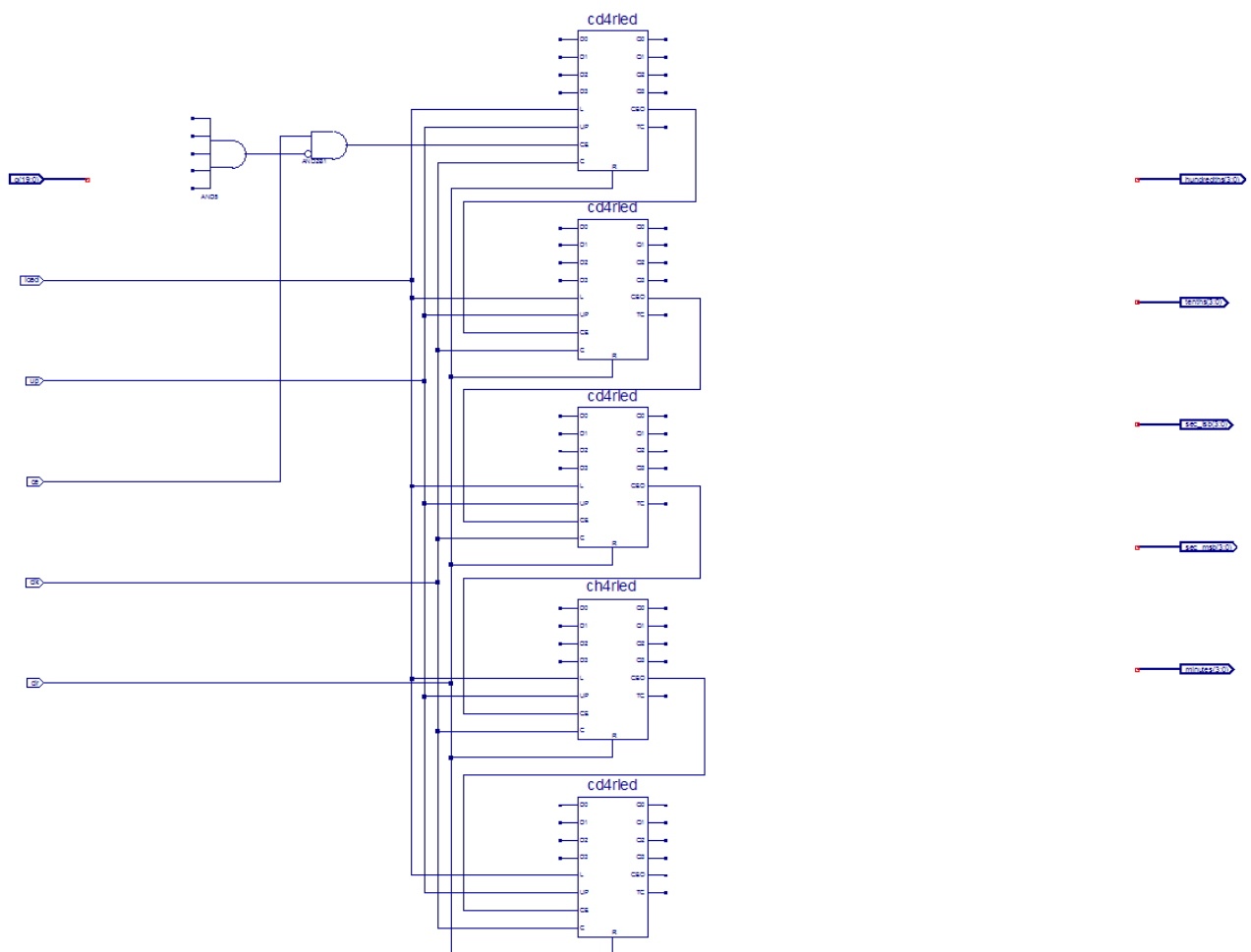

Figure 4-8: Partially Completed time\_cnt Schematic

- Follow the procedure outlined in steps 1 through 5 above to place the following components on the schematic sheet:
  - AND2b1
  - ch4rled
  - AND5
 Refer to [Figure 4-8](#) for placement locations.
- To exit the Symbols mode, press the **Esc** key on the keyboard.

For a detailed description of the functionality of Xilinx library components, right-click the component and select **Object Properties**. In the Object Properties dialog box, select **Symbol Info**. Symbol information is also available in the *Libraries Guides*. These guides are available from the ISE Software Manuals collection, automatically installed with your ISE software. To open the Software Manuals collection, select **Help > Software Manuals**. The [Software Manuals](#) collection is also available from the Xilinx website.

## Correcting Mistakes

If you make a mistake when placing a component, you can easily move or delete the component as follows:

- To move the component, click the component and drag the mouse around the window.
- To delete a placed component, use either of the following methods:
  - Click the component, and press the **Delete** key on your keyboard.
  - Right-click the component, and select **Delete**.

## Drawing Wires

You can draw wires (also called nets) to connect the components placed in the schematic. Perform the following steps to draw a net between the AND2b1 and top cd4rled components on the `time_cnt` schematic:

1. Select **Add > Wire**, or click the Add Wire toolbar button.



Figure 4-9: Add Wire Toolbar Button

2. Click the output pin of the AND2b1 and then click the destination pin CE on the cd4rled component. The Schematic Editor draws a net between the two pins.
3. Draw a net to connect the output of the AND5 component to the inverted input of the AND2b1 component. Connect the other input of the AND2b1 to the `ce` input I/O marker.
4. Connect the `load`, `up`, `clk`, and `clr` input I/O markers respectively to the `L`, `UP`, `C`, and `R` pins of each of the five counter blocks and connect the `CEO` pin of the first four counters to the `CE` pin of the next counter as shown in [Figure 4-8](#).

To specify the shape of the net, do the following:

1. Move the mouse in the direction you want to draw the net.
2. Click the mouse to create a 90-degree bend in the wire.

**Note:** To draw a net between an already existing net and a pin, click once on the component pin and once on the existing net. A junction point is drawn on the existing net.

## Adding Buses

In the Schematic Editor, a bus is simply a wire that has been given a multi-bit name. To add a bus, use the methodology for adding wires and then add a multi-bit name. After a bus has been created, you have the option of “tapping” this bus off to use each signal individually.

The next step is to create buses for each of the five outputs of the time\_cnt schematic. The results can be found in the completed schematic.

To add the buses hundredths(3:0), tenths(3:0), sec\_lsb(3:0), sec\_msb(3:0) and minutes(3:0) to the schematic, perform the following steps:

1. Select all of the output I/O markers by drawing a box around them and then drag the group so that minutes(3:0) is below the Q3 output of the bottom counter block.
2. Select **Add > Wire**, or click the Add Wire toolbar button.
3. Click in the open space just above and to the right of the top cd4rled, and then click again on the pin of the hundredths(3:0) I/O marker. The thick line should automatically be drawn to represent a bus with the name matching that of the I/O marker.

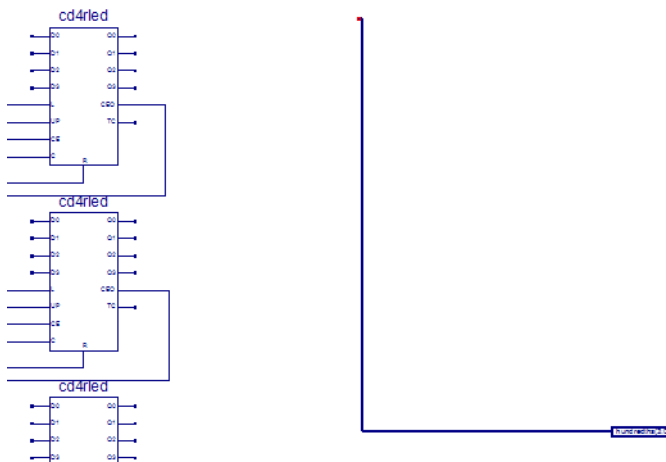

Figure 4-10: Adding a Bus

4. Repeat Steps 2 and 3 for the four remaining buses.
5. After adding the five buses, press **Esc** or right-click at the end of the bus to exit the Add Wire mode.

## Adding Bus Taps

Next, add nets to attach the appropriate pins from the cd4rled and ch4rled counters to the buses. Use bus taps to tap off a single bit of a bus and connect it to another component.

**Note:** Zooming in on the schematic enables greater precision when drawing the nets.

To tap off a single bit of each bus, do the following:

1. Select **Add > Bus Tap**, or click the Add Bus Tap toolbar button.



Figure 4-11: Add Bus Tap Toolbar Button

The cursor changes, indicating that you are now in Draw Bus Tap mode.

2. In the Add Bus Tap Options that appear in the Options panel, choose the **--> Right** orientation for the bus tap.

3. Click on the hundredths(3:0) bus with the center bar of the cursor.  
The Selected Bus Name and the Net Name values in the Options panel are now populated.  
**Note:** The indexes of the Net Name may be incremented or decremented by clicking the arrow buttons next to the Net Name box.
4. With hundredths(3) as the Net Name value, move the cursor so the tip of the attached tap touches the Q3 pin of the top cd4rled component.  
**Note:** Four selection squares appear around the pin when the cursor is in the correct position.
5. Click once when the cursor is in the correct position.  
A tap is connected to the hundredths(3:0) bus, and a wire named hundredths(3) is drawn between the tap and the Q3 pin.  
Click successively on pins Q2, Q1, and Q0 to create taps for the remaining bits of the hundredths(3:0) bus.
6. Repeat Steps 3 to 5 to tap off four bits from each of the five buses.  
**Note:** It is the name of the wire that makes the electrical connection between the bus and the wire (for example, sec\_msb(2) connects to the third bit of sec(3:0)). The bus tap figure is for visual purposes only. The following section shows additional electrical connections by name association.
7. Press **Esc** to exit the Add Bus Tap mode.
8. Compare your time\_cnt schematic with [Figure 4-13](#) to ensure that all connections are made properly.

## Adding Net Names

First, add a hanging wire to each of the five inputs of the AND5 component and to the TC pin of each of the counter blocks.

Next, add net names to the wires. To add the net names, do the following:

1. Select **Add > Net Name**, or click the Add Net Name toolbar button.



*Figure 4-12: Add Net Name Toolbar Button*

2. In the Add Net Name Options that appear in the Options panel, do the following:
  - a. In the Name field, enter **tc\_out0**.
  - b. Select **Increase the Name**.
 The net name tc\_out0 is now attached to the cursor.
3. Click the net attached to the first input of the AND5 component.  
The name is attached to the net. The net name appears above the net if the name is placed on any point of the net other than an end point.
4. Click on the remaining input nets of the AND5 to add tc\_out1, tc\_out2, tc\_out3 and tc\_out4.  
The Schematic Editor increments the net name as each name is placed on a net.  
**Note:** Alternatively, name the first net tc\_out4 and select **Decrease the name** in the Add Net Names Options, and nets are named from the bottom up.

- Repeat step 2 and then click successively on the nets connected to the TC output to add tc\_out0, tc\_out1, tc\_out2, tc\_out3, and tc\_out4 to these nets.

**Note:** Each of the wires with identical names are now electrically connected. In this case, the nets do not need to be physically connected on the schematic to make the logical connection.

Finally, connect the input pins of the counters through net name association as follows:

- Select **Add > Wire** or click the Add Wire toolbar button, and add a hanging net to the four data pins of each of the five counters.
- Select **Add > Net Name**, or click the Add Net Name toolbar button.
- In the Add Net Name Options that appear in the Options panel, enter **q(0)** in the Name field.
- Select **Increase the name**.

The net name **q(0)** is now attached to the cursor.

- Click successively on each of the nets connected to data inputs, starting from the top so that the net named q(0) is attached to the D0 pin of the top counter and the net named q(19) is attached to the D3 pin of the bottom counter. See the following figure.

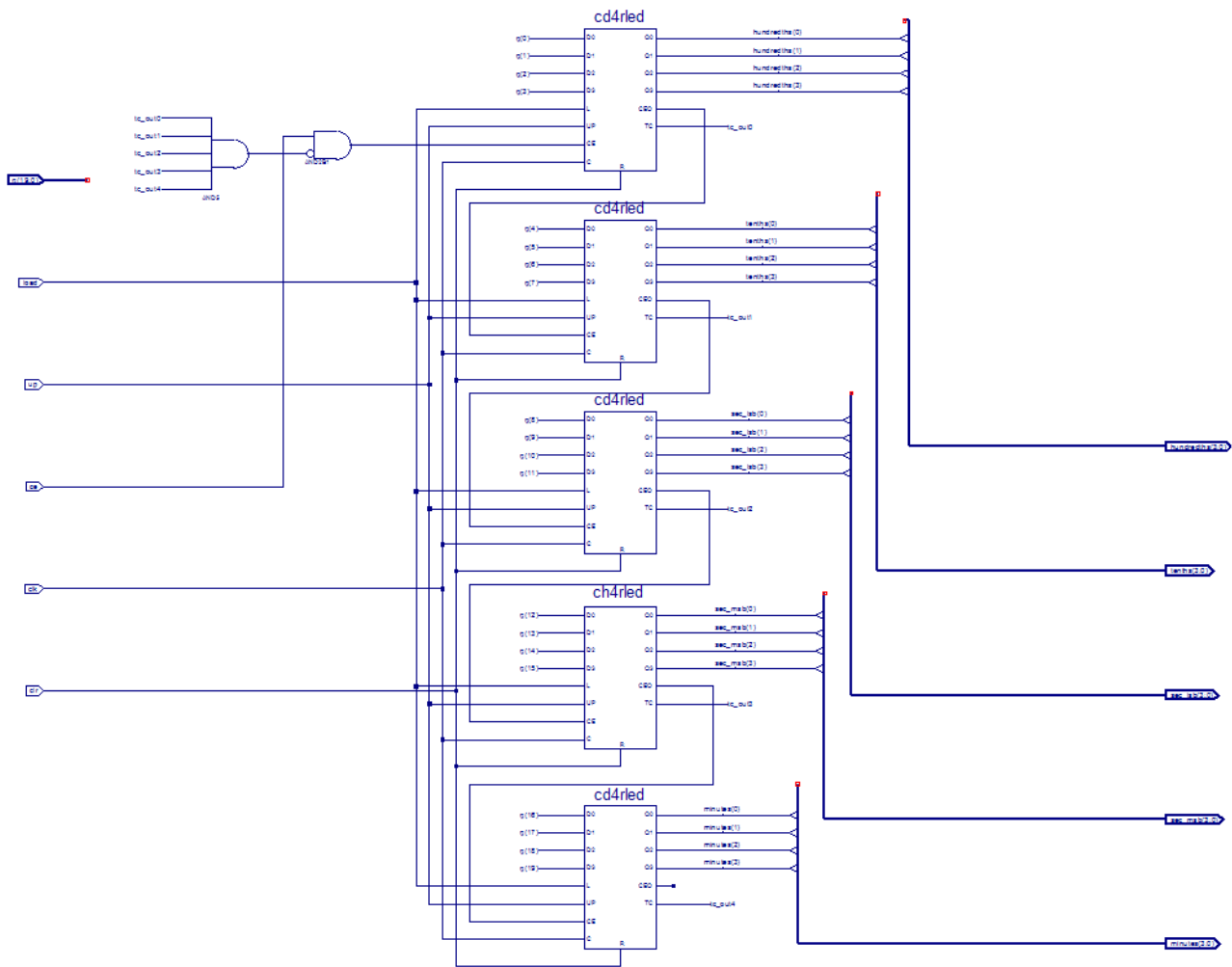

Figure 4-13: Completed time\_cnt Schematic

**Note:** If the nets appear disconnected, select **View > Refresh** to refresh the screen

## Checking the Schematic

The `time_cnt` schematic is now complete. Verify that the schematic does not contain logical errors by running a design rule check (DRC). To do this, select **Tools > Check Schematic**. The Console should report that no errors or warnings are detected. If an error or warning is displayed, fix the reported problem before proceeding.

## Saving the Schematic

Save the schematic as follows:

1. Select **File > Save**, or click the Save toolbar button.



Figure 4-14: Save Toolbar Button

2. Close the `time_cnt` schematic.

## Creating and Placing the `time_cnt` Symbol

The next step is to create a “symbol” that represents the `time_cnt` macro. The symbol is an instantiation of the macro. After you create a symbol for `time_cnt`, you will add the symbol to a top-level schematic of the stopwatch design. In the top-level schematic, the symbol of the `time_cnt` macro will be connected to other components in a later section in this chapter.

## Creating the `time_cnt` Symbol

You can create a symbol using either a Project Navigator process or a Tools menu command.

To create a symbol that represents the `time_cnt` schematic using a Project Navigator process, do the following:

1. In the Hierarchy pane of the Design panel, select `time_cnt.sch`.
2. In the Processes pane, expand **Design Utilities**, and double-click **Create Schematic Symbol**.

To create a symbol that represents the `time_cnt` schematic using a Tools menu command, do the following:

1. With the `time_cnt` schematic sheet open, select **Tools > Symbol Wizard**.
2. In the Symbol Wizard, select **Using Schematic**, and select `time_cnt`.
3. Click **Next**, then **Next**, then **Next**, and then **Finish** to use the wizard defaults.
4. View and then close the `time_cnt` symbol.



## Placing the time\_cnt Symbol

Next, place the symbol that represents the macro on the top-level schematic (`stopwatch.sch`) as follows:

1. In the Hierarchy pane of the Design panel, double-click `stopwatch.sch` to open the schematic.
2. Select **Add > Symbol**, or click the Add Symbol toolbar button.



Figure 4-15: Add Symbol Toolbar Button

3. In the Symbol Browser, select the local symbols library (`c:\xilinx_tutorial\wtut_sc`), and then select the newly created `time_cnt` symbol.
4. Place the `time_cnt` symbol in the schematic so that the output pins line up with the five buses driving inputs to the `lcd_control` component. This should be close to grid position [1612,1728]. Grid position is shown at the bottom right corner of the Project Navigator window, and is updated as the cursor is moved around the schematic.  
**Note:** Do not worry about connecting nets to the input pins of the `time_cnt` symbol. You will do this after adding other components to the `stopwatch` schematic.
5. Save the changes and close `stopwatch.sch`.

## Creating a CORE Generator Software Module

The CORE Generator software is a graphical interactive design tool that enables you to create high-level modules such as memory elements, math functions, communications, and I/O interface cores. You can customize and pre-optimize the modules to take advantage of the inherent architectural features of the Xilinx FPGA architectures, such as Fast Carry Logic, SRL16s, and distributed and block RAM.

In this section, you will create a CORE Generator software module called `timer_preset`. The module is used to store a set of 64 values to load into the timer.

### Creating the timer\_preset CORE Generator Software Module

To create a CORE Generator software module, do the following:

1. In Project Navigator, select **Project > New Source**.
2. Select **IP (Coregen & Architecture Wizard)**.
3. In the File name field, enter `timer_preset`.
4. Click **Next**.
5. Double-click **Memories & Storage Elements > RAMs & ROMs**.

6. Select **Distributed Memory Generator**, then click **Next**, and click **Finish** to open the Distributed Memory Generator customization GUI. This customization GUI enables you to customize the memory to the design specifications.

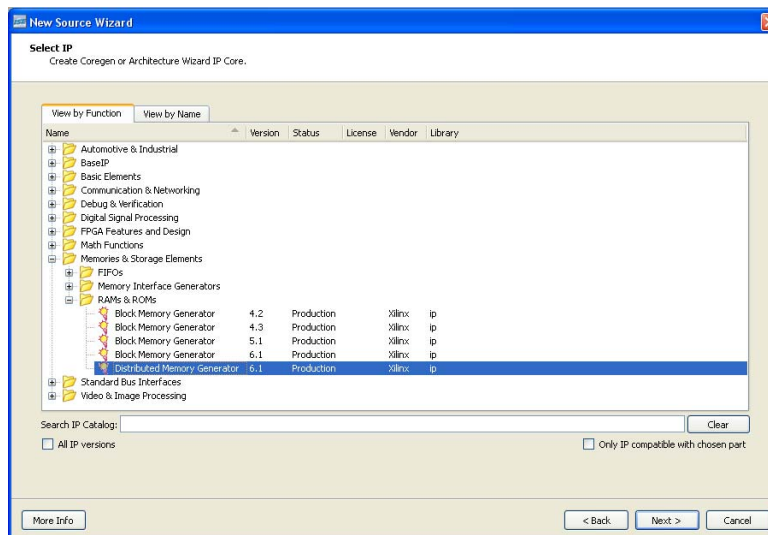

Figure 4-16: New Source Wizard—Select IP Page

7. Fill in the Distributed Memory Generator customization GUI with the following settings:
  - Component Name: **timer\_preset** (defines the name of the module)
  - Depth: **64** (defines the number of values to be stored)
  - Data Width: **20** (defines the width of the output bus)
  - Memory Type: **ROM**
8. Click **Next**.

9. Leave Input and Output options as **Non Registered**, and click **Next**.

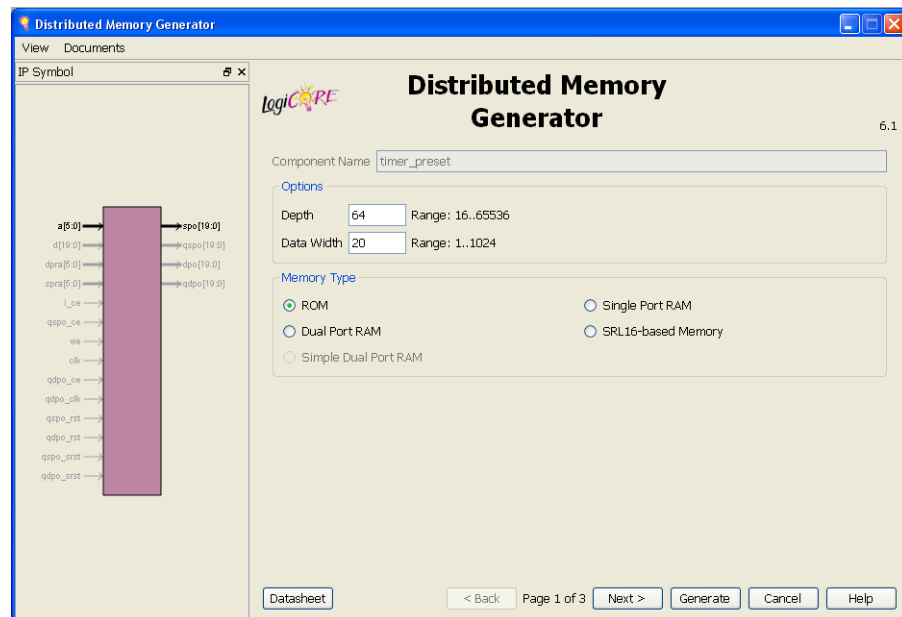

Figure 4-17: CORE Generator Software—Distributed Memory Generator Customization GUI

10. To specify the Coefficients File, click the **Browse** button, and select `definition1_times.coe`.
11. Check that *only* the following pins are used (used pins are highlighted on the symbol on the left side of the customization GUI):
- **a[5:0]**
  - **spo[19:0]**
12. Click **Generate**.

The module is created and automatically added to the project library.

A number of files are added to the `ipcore_dir` sub-directory of the project directory. Following is a list of some of these files:

- *timer\_preset.sym*  
This file is a schematic symbol file.
- *timer\_preset.vhd* or *timer\_preset.v*  
These are HDL wrapper files for the core and are used only for simulation.
- *timer\_preset.ngc*  
This file is the netlist that is used during the Translate phase of implementation.

- *timer\_preset.xco*  
This file stores the configuration information for the timer\_preset module and is used as a project source.
- *timer\_preset.mif*  
This file provides the initialization values of the ROM for simulation.

## Creating a DCM Module

The Clocking Wizard, a Xilinx Architecture Wizard, enables you to graphically select Digital Clock Manager (DCM) features that you want to use. In this section, you will create a basic DCM module with CLK0 feedback and duty-cycle correction.

### Using the Clocking Wizard

Create the dcm1 module as follows:

1. In Project Navigator, select **Project > New Source**.
2. In the New Source Wizard, select the **IP (Coregen & Architecture Wizard)** source type, and enter **dcm1** for the file name.
3. Click **Next**.
4. In the Select IP dialog box, select **FPGA Features and Design > Clocking > Spartan-3E, Spartan-3A > Single DCM\_SP**.

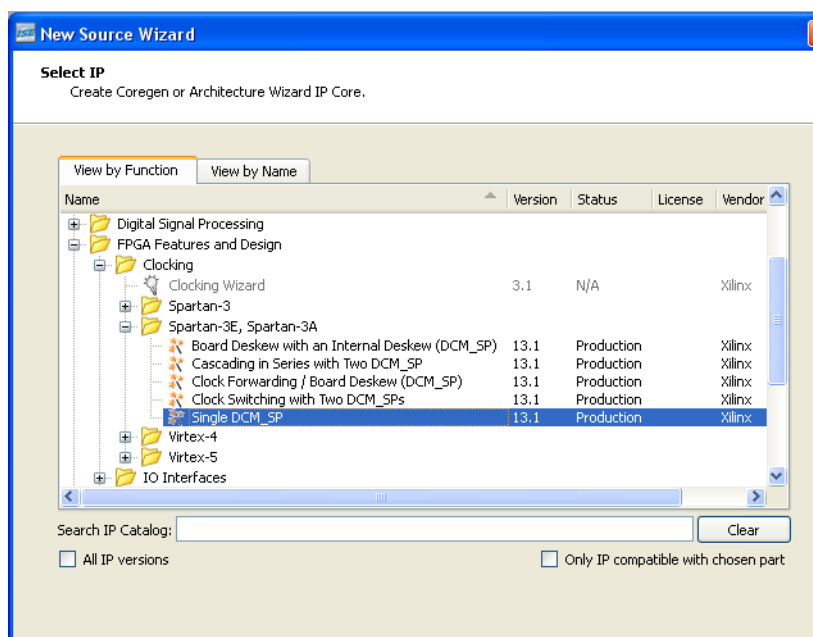

Figure 4-18: Selecting Single DCM Core Type

5. Click **Next**, then click **Finish**. The Clocking Wizard opens.
6. In the Architecture Wizard Setup page, select **OK**.
7. In the General Setup page, verify that **RST**, **CLK0** and **LOCKED** ports are selected.
8. Select **CLKFX** port.

9. Type **50** and select **MHz** for the Input Clock Frequency.
10. Verify the following settings:
  - Phase Shift: **NONE**
  - CLKIN Source: **External, Single**
  - Feedback Source: **Internal**
  - Feedback Value: **1X**
  - Use Duty Cycle Correction: Selected

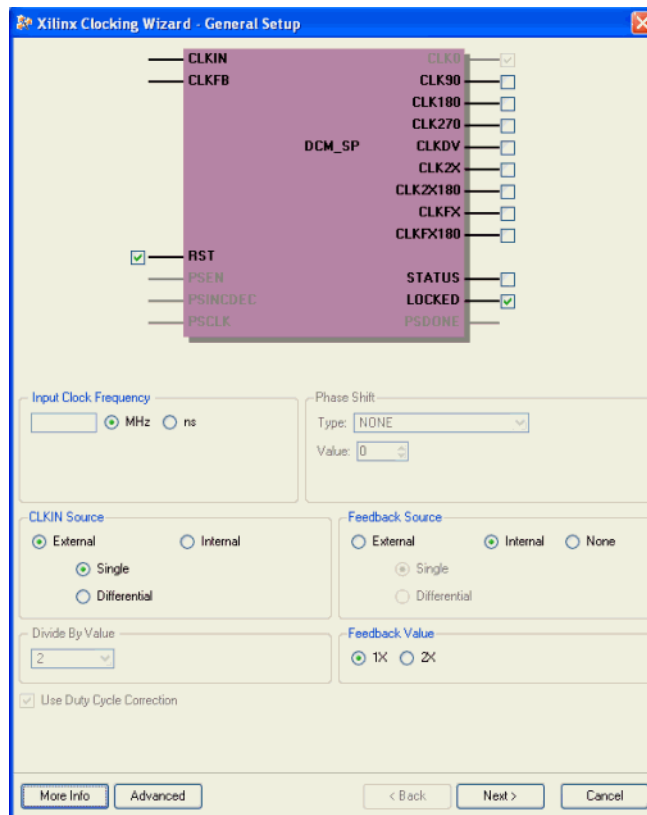

Figure 4-19: Xilinx Clocking Wizard—General Setup

11. Click the **Advanced** button.
12. Select the **Wait for DCM Lock before DONE Signal goes high** option.
13. Click **OK**.
14. Click **Next**, and then **Next** again.
15. Select **Use output frequency** and enter **26.2144** in the box and select **MHz**.

$$(26.2144\text{MHz}) / 2^{18} = 100\text{Hz}$$

16. Click **Next**, and then click **Finish**.

The dcm1 .xaw file is created and added to the list of project source files in the Hierarchy pane of the Design panel.

## Creating the dcm1 Symbol

Next, create a symbol representing the dcm1 macro. This symbol will be added to the top-level schematic (`stopwatch.sch`) later in the tutorial.

1. In Hierarchy pane of the Project Navigator Design panel, select `dcm1.xaw`.
2. In the Processes pane, double-click **Create Schematic Symbol**.

## Creating an HDL-Based Module

With the ISE software, you can easily create modules from HDL code. The HDL code is connected to your top-level schematic design through instantiation and compiled with the rest of the design.

You will author a new HDL module. This macro will be used to debounce the `strtstop`, `mode`, and `lap_load` inputs.

## Using the New Source Wizard and ISE Text Editor

In this section, you create a file using the New Source wizard, specifying the name and ports of the component. The resulting HDL file is then modified in the ISE Text Editor.

To create the source file, do the following:

1. Select **Project > New Source**.
2. Select **VHDL Module** or **Verilog Module**.
3. In the File Name field, enter **debounce**.
4. Click **Next**.
5. Enter two input ports named `sig_in` and `clk` and an output port named `sig_out` for the debounce component as follows:
  - a. In the first three Port Name fields, enter **sig\_in**, **clk** and **sig\_out**.
  - b. Set the Direction field to **input** for `sig_in` and `clk` and to **output** for `sig_out`.
  - c. Leave the Bus designation boxes unchecked.

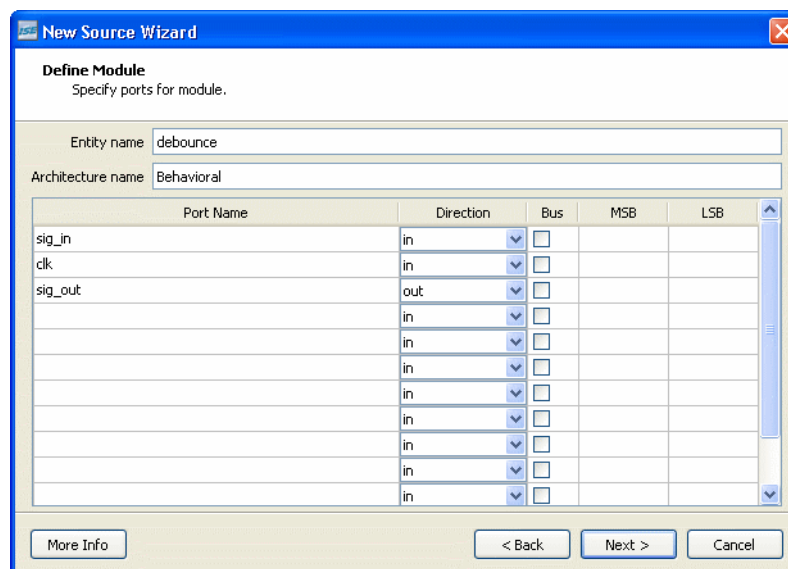

Figure 4-20: New Source Wizard

6. Click **Next** to view a description of the module.
7. Click **Finish** to open the empty HDL file in the ISE Text Editor.

The VHDL file is shown in the following figure.

```

7  -- Module Name:      debounce - Behavioral
8  -- Project Name:
9  -- Target Devices:
10 -- Tool versions:
11 -- Description:
12 --
13 -- Dependencies:
14 --
15 -- Revision:
16 -- Revision 0.01 - File Created
17 -- Additional Comments:
18 --
19 -----
20 library IEEE;
21 use IEEE.STD_LOGIC_1164.ALL;
22 use IEEE.STD_LOGIC_ARITH.ALL;
23 use IEEE.STD_LOGIC_UNSIGNED.ALL;
24
25 ---- Uncomment the following library declaration if instantiating
26 ---- any Xilinx primitives in this code.
27 --library UNISIM;
28 --use UNISIM.VComponents.all;
29
30 entity debounce is
31     Port ( sig_in : in  STD_LOGIC;
32           clk : in  STD_LOGIC;
33           sig_out : out STD_LOGIC);
34 end debounce;
35
36 architecture Behavioral of debounce is
37
38 begin
39
40
41 end Behavioral;
42

```

Figure 4-21: VHDL File in ISE Text Editor

The Verilog HDL file is shown in the following figure.

```

1  `timescale 1ns / 1ps
2  ////////////////////////////////////////////////////////////////////
3  // Company:
4  // Engineer:
5  //
6  // Create Date:      14:12:53 03/15/2007
7  // Design Name:
8  // Module Name:      debounce
9  // Project Name:
10 // Target Devices:
11 // Tool versions:
12 // Description:
13 //
14 // Dependencies:
15 //
16 // Revision:
17 // Revision 0.01 - File Created
18 // Additional Comments:
19 //
20 ////////////////////////////////////////////////////////////////////
21 module debounce(sig_in, clk, sig_out);
22     input sig_in;
23     input clk;
24     output sig_out;
25
26
27 endmodule
28

```

Figure 4-22: Verilog File in ISE Text Editor

In the ISE Text Editor, the ports are already declared in the HDL file, and some of the basic file structure is already in place. Keywords are displayed in blue, comments in green, and values are black. The file is color-coded to enhance readability and help you recognize typographical errors.

## Using the Language Templates

The ISE Language Templates include HDL constructs and synthesis templates which represent commonly used logic components, such as counters, D flip-flops, multiplexers, and primitives. You will use the Debounce Circuit template for this exercise.

**Note:** You can add your own templates to the Language Templates for components or constructs that you use often.

To invoke the Language Templates and select the template for this tutorial, do the following:

1. From Project Navigator, select **Edit > Language Templates**.

Each HDL language in the Language Templates is divided into the following sections: Common Constructs, Device Macro Instantiation, Device Primitive Instantiation, Simulation Constructs, Synthesis Constructs, and User Templates. To expand the view of any of these sections, click the plus symbol (+) next to the section. Click any of the listed templates to view the template contents in the right pane.

2. Under either the VHDL or Verilog hierarchy, expand **Synthesis Constructs**, expand **Coding Examples**, expand **Misc**, and select the template called **Debounce Circuit**. Use the appropriate template for the language you are using.

When the template is selected in the hierarchy, the contents display in the right pane.

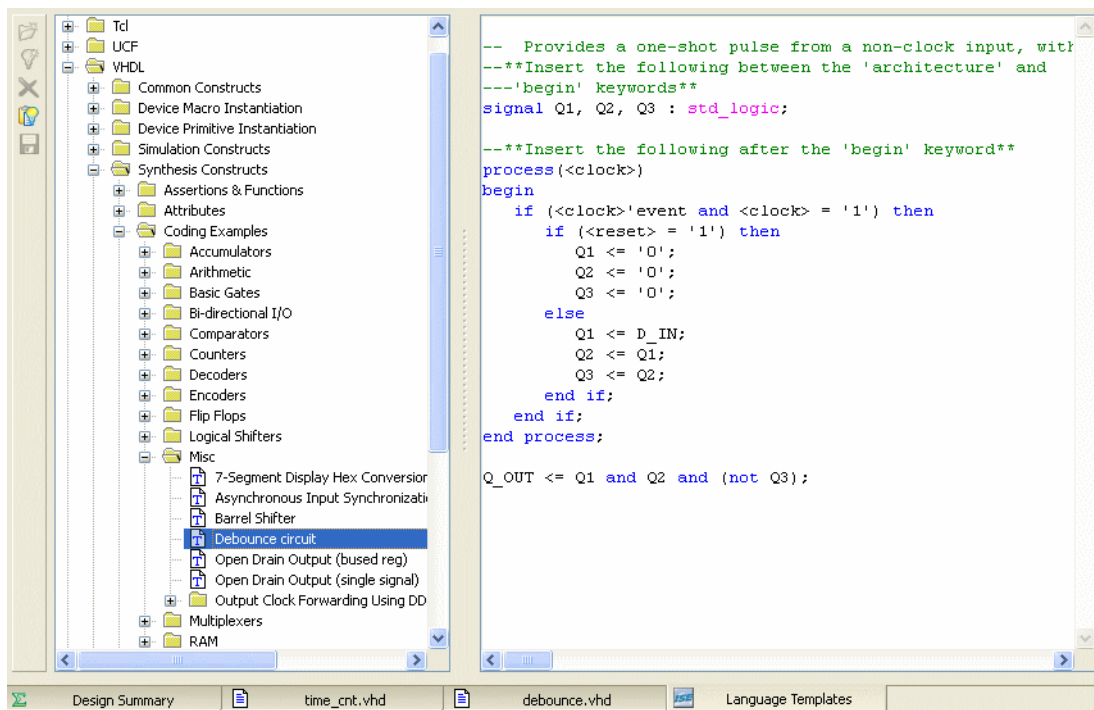

Figure 4-23: Language Templates



## Adding a Language Template to a File

You will now use “Use in File” method for adding templates to your HDL file. Refer to “Working with Language Templates” in the ISE Help for additional usability options, including drag and drop options.

To add the template to your HDL file, do the following:

1. With the `debounce.v` or `debounce.vhd` source file active, position the cursor under the architecture begin statement in the VHDL file, or under the module and pin declarations in the Verilog file.
2. Return to the Language Templates window, right-click on the **Debounce Circuit** template in the template index, and select **Use In File**.

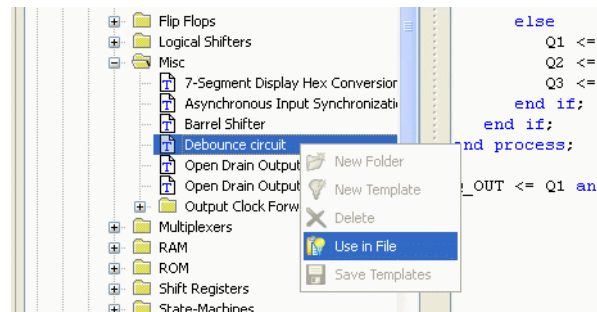

Figure 4-24: Selecting Language Template to Use in File

3. Close the Language Templates window.
4. Open the `debounce.v` or `debounce.vhd` source file to verify that the Language Template was properly inserted.
5. *Verilog only:* Complete the Verilog module by doing the following:
  - a. Remove the reset logic (not used in this design) by deleting the three lines beginning with `if` and ending with `else`.
  - b. Change `<reg_name>` to **q** in all six locations.
  - c. Change `<clock>` to **clk**; `<input>` to **sig\_in**; and `<output>` to **sig\_out**.

**Note:** You can select **Edit > Find & Replace** to facilitate this. The Find fields appear at the bottom of the Text Editor.
6. *VHDL only:* Complete the VHDL module by doing the following:
  - a. Move the line beginning with the word `signal` so that it is between the architecture and `begin` keywords.
  - b. Remove the reset logic (not used in this design) by deleting the five lines beginning with `if (<reset>...` and ending with `else`, and delete one of the `end if;` lines.
  - c. Change `<clock>` to **clk**; `D_IN` to **sig\_in**; and `Q_OUT` to **sig\_out**.

**Note:** You can select **Edit > Find & Replace** to facilitate this. The Find fields appear at the bottom of the Text Editor.
7. Save the file by selecting **File > Save**.
8. Select one of the `debounce` instances in the Hierarchy pane.
9. In the Processes pane, double-click **Check Syntax**. Verify that the syntax check passes successfully. Correct any errors as necessary.
10. Close the ISE Text Editor.

## Creating Schematic Symbols for HDL Modules

Next, create the schematic symbols for both the `debounce.vhd` and `statmach.vhd` files as follows:

1. In the Hierarchy pane of the Project Navigator Design panel, select `debounce.vhd` or `debounce.v`.
2. In the Processes panel, expand **Design Utilities**, and double-click **Create Schematic Symbol**.
3. Repeat this procedure for the `statmach.vhd` file.

You are now ready to place the symbols on the stopwatch schematic.

## Placing the `statmach`, `timer_preset`, `dcm1`, and `debounce` Symbols

You can now place the `statmach`, `timer_preset`, `dcm1`, and `debounce` symbols on the stopwatch schematic (`stopwatch.sch`).

To place the symbols, do the following:

1. In the Hierarchy pane of the Project Navigator Design panel, double-click `stopwatch.sch`.  
The schematic file opens in the Workspace.
2. Select **Add > Symbol**, or click the Add Symbol toolbar button.



Figure 4-25: Add Symbol Toolbar Button

The Symbol Browser appears in the Options panel to the left of the schematic. The Symbol Browser displays the libraries and their corresponding components.

3. View the list of available library components in the Symbol Browser.
4. Locate the project-specific macros by selecting the project directory name in the Categories window.

**Note:** The `timer_preset` symbol is located in the `ipcore_dir` directory.

5. Select the appropriate symbol, and add it to the stopwatch schematic in the approximate location, as shown in [Figure 4-26](#).

**Note:** Do not worry about drawing the wires to connect the symbols. You will connect components in the schematic later in the tutorial.

6. Save the schematic.

The following figure shows the stopwatch schematic with placed symbols.

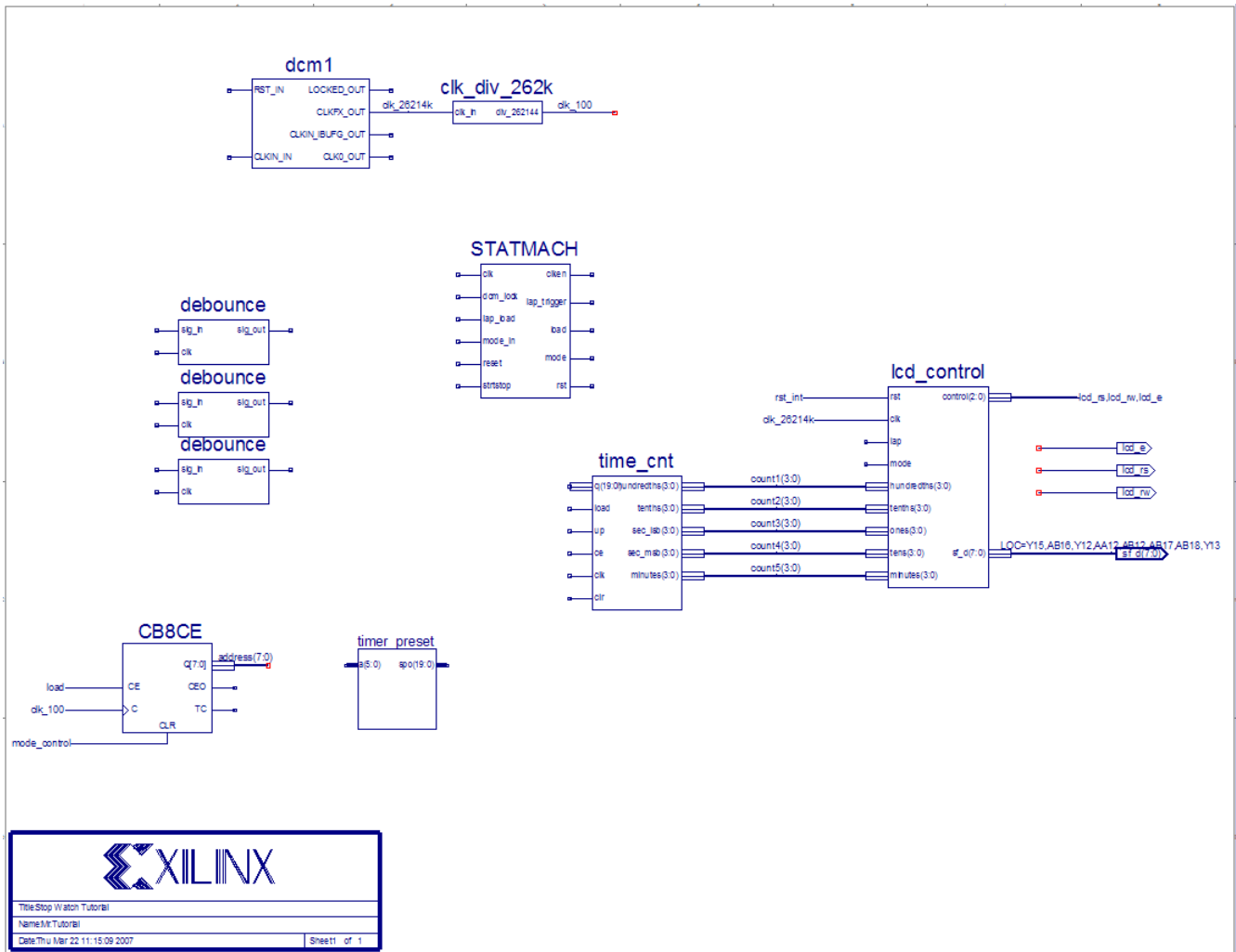

Figure 4-26: Placing Design Macros

## Changing Instance Names

When a symbol is placed on a schematic sheet, it is given a unique instance name beginning with the prefix `XLXI_`. To help make the hierarchy more readable in the Project Navigator Hierarchy pane, change the names of the added symbol instances as follows:

1. Right-click on the `dcm1` symbol instance, and select **Object Properties**.
2. In the Object Properties dialog box, change the value of the `InstName` field to **`dcm_inst`**, and click **OK**.
3. Repeat steps 1 and 2 to change the following symbol instance names:
  - Name the `statmach` instance **`timer_state`**.
  - Name the top debounce instance **`lap_load_debounce`**.
  - Name the middle debounce instance **`mode_debounce`**.
  - Name the bottom debounce instance **`strtstop_debounce`**.
  - Name the `timer_preset` instance **`t_preset`**.
  - Name the `time_cnt` instance **`timer_cnt`**.

## Using Hierarchy Push/Pop

First, perform a hierarchy “push down,” which enables you to focus in on a lower-level of the schematic hierarchy to view the underlying file. Push down into the `time_cnt` macro, which is a schematic-based macro created earlier in this tutorial, and examine its components.

To push down into `time_cnt` from the top-level stopwatch schematic, do the following:

1. Click `time_cnt` symbol in the schematic, and select the Hierarchy Push toolbar button. You can also right-click the macro, and select **Symbol > Push into Symbol**.



Figure 4-27: Hierarchy Push Toolbar Button

In the `time_cnt` schematic, you see five counter blocks. Push into any of the counter blocks by selecting the block and clicking on the Hierarchy Push toolbar button. This process may be repeated until the schematic page contains only Xilinx primitive components. If you push into a symbol that has an underlying HDL or IP core file, the appropriate text editor or customization GUI opens, which enables you to edit the file.

2. After examining the macro, return to the top-level schematic by selecting **View > Pop to Calling Schematic**, or select the Hierarchy Pop toolbar button when nothing in the schematic is selected. You can also right-click in an open space of the schematic, and select **Pop to Calling Schematic**.



Figure 4-28: Hierarchy Pop Toolbar Button

## Specifying Device Inputs/Outputs

Use the I/O marker to specify device I/O on a schematic sheet. All of the Schematic Editor schematics are netlisted to VHDL or Verilog and then synthesized by the synthesis tool of choice. When the synthesis tool synthesizes the top-level schematic HDL, the I/O markers are replaced with the appropriate pads and buffers.

### Adding Input Pins

Next, add five input pins to the stopwatch schematic: reset, clk, lap\_load, mode and strtstop.

To add these components, draw a hanging wire to the two inputs of dcm1 and to the sig\_in pin of each debounce symbol.

**Note:** Refer to [Drawing Wires](#) for detailed instructions.

### Adding I/O Markers and Net Names

It is important to label nets and buses for the following reasons:

- Aids in debugging and simulation, because you can more easily trace nets back to your original design.  
For example, any nets that remain unnamed in the design will be given generated names that will mean nothing to you later in the implementation process.
- Enhances readability and aids in documenting your design.

Label the five input nets you just drew. Refer to the completed schematic below. To label the reset net, do the following:

1. Select **Add > Net Name**.
2. In the Add Net Name Options that appear in the Options panel, enter **reset** in the Name box.  
The net name is now attached to the cursor.
3. Place the name on the leftmost end of the net, as shown in [Figure 4-29](#).
4. Repeat Steps 1 through 3 for the clk, lap\_load, mode, and strtstop pins.  
After all of the nets have been labeled, add the I/O marker.
5. Select **Add > I/O Marker**.

- Click and drag a box around the name of the five labeled nets to place an input port on each net, as shown in the following figure.

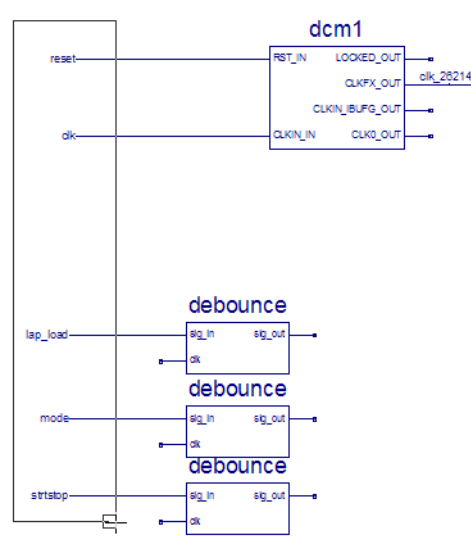

Figure 4-29: Adding I/O Markers to Labeled Nets

## Assigning Pin Locations

Xilinx recommends that you let the automatic Place and Route (PAR) program define the pinout of your design. Pre-assigning locations to the pins can sometimes degrade the performance of the Place and Route tools. However, it may be necessary at some point to lock the pinout of a design so that it can be integrated into a Printed Circuit Board (PCB).

For this tutorial, the inputs and outputs will be locked to specific pins in order to place and download the design to the Spartan-3A demo board. Because the tutorial stopwatch design is simple and timing is not critical, the example pin assignments will not adversely affect the ability of PAR to place and route the design.

Assign a LOC parameter to the output nets on the stopwatch schematic as follows:

- Right-click on the `clk` net, and select **Object Properties**.
- In the Object Properties dialog box, click the **New** button.
- In the New Attribute dialog box, enter **LOC** for the Attribute Name and **E12** for the Attribute Value.

- Click **OK** to return to the Object Properties dialog box.

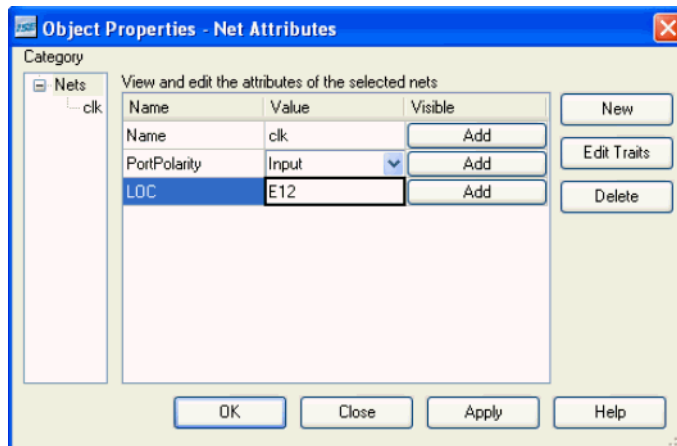

Figure 4-30: Assigning Pin Locations

- To make the LOC attribute visible, select the **Add** button next to the LOC attribute.
- In the Net Attribute Visibility dialog box, click on a location near the center of the displayed net, and then click **OK**.

This will display the LOC attribute on the schematic above the clk net.

- Click **OK** to close the Object Properties dialog box.

The above procedure constrains clk to pin E12. Notice that the LOC property has already been added to the sf\_d(7:0) bus. The remaining pin location constraints will be added in [Using the Constraints Editor](#) and [Assigning I/O Locations Using PlanAhead Software](#) of Chapter 6, Design Implementation.

**Note:** To turn off the location constraint without deleting it, select the loc attribute, and click **Edit Traits**. Select **VHDL or Verilog** and select **Ignore this attribute**.

## Completing the Schematic

Complete the schematic by wiring the components you have created and placed, adding any additional necessary logic, and labeling nets appropriately. The following steps guide you through the process of completing the schematic. You may also want to use the completed schematic shown below to complete the schematic. Each of the actions referred

to in this section has been discussed in detail in earlier sections of the tutorial. Please see the earlier sections for detailed instructions.

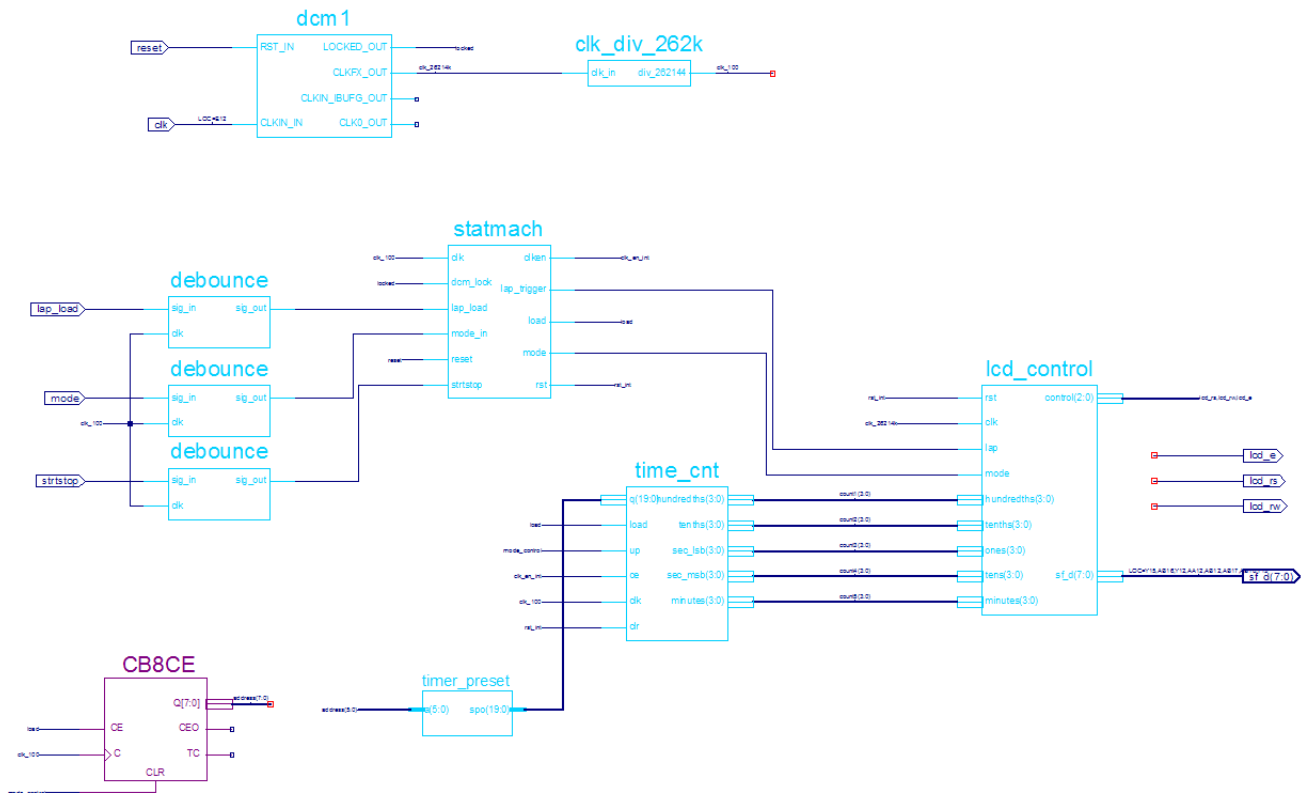

Figure 4-31: Completed Stopwatch Schematic

To complete the schematic diagram, do the following:

1. Draw a hanging wire to the LOCKED\_OUT pin of DCM1 and name the wire **locked**. See [Drawing Wires](#) and [Adding Net Names](#).
2. Draw a hanging wire to the clk input of both the time\_cnt and statmach macros. See [Drawing Wires](#).
3. Name both wires **clk\_100**. See [Adding Net Names](#).
 

**Note:** Remember that nets are logically connected if their names are the same, even if the net is not physically drawn as a connection in the schematic. This method is used to make the logical connection of clk\_100 and several other signals.
4. Draw a wire to connect the clk inputs of the three debounce macros and name the wire **clk\_100**.
5. Draw wires between the sig\_out pins of the debounce components and the lap\_load, mode\_in, and strtstop pin of the statmach macro. Label the nets **lap\_debounced**, **mode\_debounced**, and **strtstop\_debounced**. See [Drawing Wires](#) and [Adding Net Names](#).
6. Add hanging wires to the dcm\_lock pin and the reset pin of the statmach macro. Name them **locked** and **reset**, respectively.
7. Draw a hanging wire to the clken output of the statmach component and another hanging wire to the ce pin of the time\_cnt component. Name both wires **clk\_en\_int**.



8. Draw hanging wires from the rst output pin of the statmach macro and the clr pin of the time\_cnt macro. See [Drawing Wires](#). Label both wires **rst\_int**.
9. Draw a wire from the bus output of the timer\_preset to the q(19:0) input of the time\_cnt macro. See [Drawing Wires](#). Notice how the wire is automatically converted to a bus.
10. Draw a hanging bus on the input of the timer\_preset macro and name the bus **address (5:0)**.
11. Draw wires from the lap\_trigger and mode outputs of the statmach macro to the lap and mode inputs of the lcd\_control macro. See [Drawing Wires](#). Name the nets **lap** and **mode\_control** respectively.
12. Draw hanging wires from the load output of the statmach macro and the load input of the time\_cnt macro. See [Drawing Wires](#). Name both wires **load**.
13. Draw a hanging wire to the up input time\_cnt macro. See [Drawing Wires](#). Name the wire **mode\_control**.
14. Save the design by selecting **File > Save**.

You have now completed the schematic design.

To continue with the schematic flow, do either of the following:

- Go to [Chapter 5, Behavioral Simulation](#), to perform a pre-synthesis simulation of this design.
- Proceed to [Chapter 6, Design Implementation](#), to place and route the design.



# Behavioral Simulation

---

## Overview of Behavioral Simulation Flow

The Xilinx® ISE® Design Suite provides an integrated flow with the Mentor ModelSim simulator and the Xilinx ISim simulator that allows simulations to be run from the Xilinx Project Navigator. The examples in this tutorial demonstrate how to use the integrated flow. Whether you use the ModelSim simulator or the ISim simulator with this tutorial, you will achieve the same simulation results.

For additional information about simulation, and for a list of other supported simulators, see the *Synthesis and Simulation Design Guide (UG626)*. This guide is available from the ISE Software Manuals collection, automatically installed with your ISE software. To open the Software Manuals collection, select **Help > Software Manuals**. The [Software Manuals](#) collection is also available from the Xilinx website.

This tutorial provides an introduction to the simulation flow within Project Navigator, including highlights of features within the ModelSim and ISim simulators. For more detailed information about using these simulators, see the ModelSim documentation available from the [ModelSim website](#) or the ISim tutorial provided with the ISE Design Suite [Tutorials](#) available from the Xilinx website.

## ModelSim Setup

To use this tutorial, you must install ModelSim on your computer. ModelSim PE, ModelSim SE, and ModelSim DE are full versions of ModelSim available for purchase directly from Mentor Graphics. To simulate with the ISE Design Suite libraries, use ModelSim 6.5c or newer. Older versions may work but are not supported. For more information about ModelSim PE, SE, and DE, please contact Mentor Graphics.

## ISim Setup

ISim is automatically installed and set up with the ISE Design Suite installer on supported operating systems. To see a list of operating systems supported by ISim, please see the [ISE Design Suite: Release Notes Guide \(UG631\)](#) available from the Xilinx website.

## Getting Started

The following sections outline the requirements for performing behavioral simulation in this tutorial.

### Required Files

The behavioral simulation flow requires design files, a test bench file, and Xilinx simulation libraries.

### Design Files (VHDL, Verilog, or Schematic)

This chapter assumes that you have completed the design entry tutorial in either [Chapter 3, HDL-Based Design](#), or [Chapter 4, Schematic-Based Design](#). After you have completed one of these chapters, your design includes the required design files and is ready for simulation.

### Test Bench File

To simulate the design, a test bench file is required to provide stimulus to the design. VHDL and Verilog test bench files are available with the tutorial files. You may also create your own test bench file.

### Simulation Libraries

Xilinx simulation libraries are required when a Xilinx primitive or IP core is instantiated in the design. The design in this tutorial requires the use of simulation libraries because it contains instantiations of a digital clock manager (DCM) and a CORE Generator™ software component. For information on simulation libraries and how to compile them, see the next section, [Xilinx Simulation Libraries](#).

## Xilinx Simulation Libraries

To simulate designs that contain instantiated Xilinx primitives, CORE Generator software components, and other Xilinx IP cores you must use the Xilinx simulation libraries. These libraries contain models for each component. These models reflect the functions of each component, and provide the simulator with the information required to perform simulation.

For a detailed description of each library, see the *Synthesis and Simulation Design Guide (UG626)*. This guide is available from the ISE Software Manuals collection, automatically installed with your ISE software. To open the Software Manuals collection, select **Help > Software Manuals**. The [Software Manuals](#) collection is also available from the Xilinx website.

## Updating the Xilinx Simulation Libraries

The Xilinx simulation libraries contain models that are updated on a regular basis:

- XilinxCoreLib models are updated each time an IP Update is installed.
- All other models are updated each time a software update is installed.

When the models are updated, you must recompile the libraries. The compiled Xilinx simulation libraries are then available during the simulation of any design.

### ModelSim PE, SE, or DE

If you are using ModelSim PE, SE, or DE, you must compile the simulation libraries with the updated models. See the *Synthesis and Simulation Design Guide (UG626)*. This guide is available from the ISE Software Manuals collection, automatically installed with your ISE software. To open the Software Manuals collection, select **Help > Software Manuals**. The [Software Manuals](#) collection is also available from the Xilinx website.

### Xilinx ISim

Updated simulation libraries for ISim are precompiled and installed with ISE software installations.

## Mapping Simulation Libraries in the modelsim.ini File

ModelSim uses the `modelsim.ini` file to determine the location of the compiled libraries. For example, if you compiled the UNISIM library to `c:\lib\UNISIM`, the following mapping appears in the `modelsim.ini` file:

```
UNISIM = c:\lib\UNISIM
```

**Note:** The `modelsim.ini` is not applicable to ISim.

ModelSim searches for a `modelsim.ini` file in the following locations until one is found:

- `modelsim.ini` file pointed to by the MODELSIM environment variable.
- `modelsim.ini` file in the current working directory.
- `modelsim.ini` file in the directory where ModelSim is installed.

If the MODELSIM environment variable is not set, and the `modelsim.ini` file has not been copied to the working directory, the `modelsim.ini` file in the ModelSim installation directory is used.

### ModelSim PE, SE, or DE

If you are using ModelSim PE, SE, or DE, refer to the *Command Line Tools User Guide (UG628)* and use COMPXLIB to compile the libraries. This guide is available from the ISE Software Manuals collection, automatically installed with your ISE software. To open the Software Manuals collection, select **Help > Software Manuals**. The [Software Manuals](#) collection is also available from the Xilinx website.

While compiling the libraries, COMPXLIB also updates the `modelsim.ini` file with the correct library mapping. Open the `modelsim.ini` file, and make sure that the library mappings are correct.

For future projects, you can copy the `modelsim.ini` file to the working directory and make changes that are specific to that project, or you can use the MODELSIM environment variable to point to the desired `modelsim.ini` file.

ISim

The `modelsim.ini` file is not applicable to ISim.

## Adding an HDL Test Bench

To add an HDL test bench to your design project, you can either add a test bench file provided with this tutorial, or create your own test bench file and add it to your project.

### Adding the Tutorial Test Bench File

This section demonstrates how to add an existing test bench file to the project. A VHDL test bench and Verilog test fixture are provided with this tutorial.

**Note:** To create your own test bench file in the ISE software, select **Project > New Source**, and select either **VHDL Test Bench** or **Verilog Text Fixture** in the New Source Wizard. An empty stimulus file is added to your project. You must define the test bench in a text editor.

### VHDL Simulation

To add the tutorial VHDL test bench to the project, do the following:

1. In Project Navigator, select **Project > Add Source**.
2. Select the test bench file `stopwatch_tb.vhd`.
3. Click **Open**.
4. Ensure that **Simulation** is selected for the file association type.
5. Click **OK**.

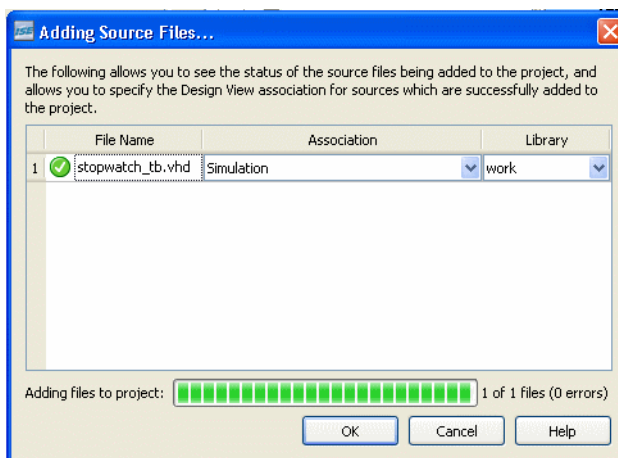

Figure 5-1: Adding VHDL Test Bench

## Verilog Simulation

To add the tutorial Verilog test fixture to the project, do the following:

1. In Project Navigator, select **Project > Add Source**.
2. Select the file `stopwatch_tb.v`.
3. Click **Open**.
4. Ensure that **Simulation** is selected for the file association type.
5. Click **OK**.

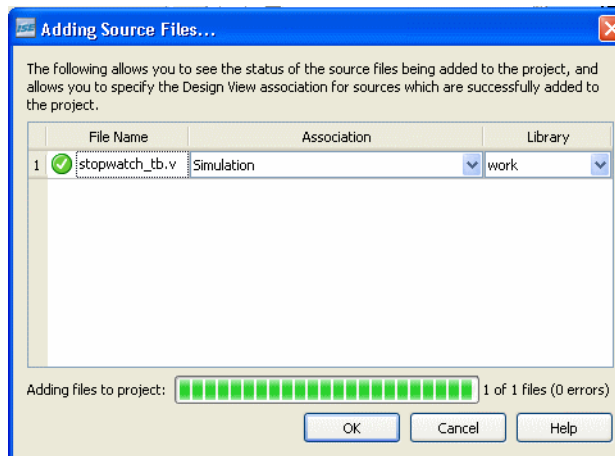

Figure 5-2: Adding Verilog Test Fixture

## Behavioral Simulation Using ModelSim

Now that you have a test bench in your project, you can perform behavioral simulation on the design using the ModelSim simulator. The ISE software has full integration with the ModelSim simulator. The ISE software enables ModelSim to create the work directory, compile the source files, load the design, and perform simulation based on simulation properties.

To simulate with ISim, skip to [Behavioral Simulation Using ISim](#). Whether you choose to use the ModelSim simulator or the ISim simulator for this tutorial, the end result is the same.

To select ModelSim as your project simulator, do the following:

1. In the Hierarchy pane of the Project Navigator Design panel, right-click the device line (xc3s700A-4fg484), and select **Design Properties**.
2. In the Design Properties dialog box, set the Simulator field to **ModelSim** (with the appropriate type and language).

## Locating the Simulation Processes

The simulation processes in the ISE software enable you to run simulation on the design using ModelSim. To locate the ModelSim simulator processes, do the following:

1. In the View pane of the Project Navigator Design panel, select **Simulation**, and select **Behavioral** from the drop-down list.
2. In the Hierarchy pane, select the test bench file (`stopwatch_tb`).

- In the Processes pane, expand **ModelSim Simulator** to view the process hierarchy. The **Simulate Behavioral Model** process is available, which starts the design simulation.

If ModelSim is installed but the processes are not available, the Project Navigator preferences may not be set correctly. To set the ModelSim location, do the following:

- Select **Edit > Preferences**.
- In the Preferences dialog box, expand **ISE General**, and click **Integrated Tools**.
- In the right pane, under Model Tech Simulator, browse to the location of the modelsim executable (for example: C:\modeltech\_xe\win32xoe\modelsim.exe).

## Specifying Simulation Properties

You will perform a behavioral simulation on the stopwatch design after you set process properties for simulation.

The ISE software allows you to set several ModelSim simulator properties in addition to the simulation netlist properties. To see the behavioral simulation properties and to modify the properties for this tutorial, do the following:

- In the Hierarchy pane of the Project Navigator Design panel, select the test bench file (stopwatch\_tb).
- In the Processes pane, expand **ModelSim Simulator**, right-click **Simulate Behavioral Model**, and select **Process Properties**.
- In the Process Properties dialog box (Figure 5-3), set the Property display level to **Advanced**.

This global setting enables you to see all available properties.

- Change the Simulation Run Time to **2000 ns**.

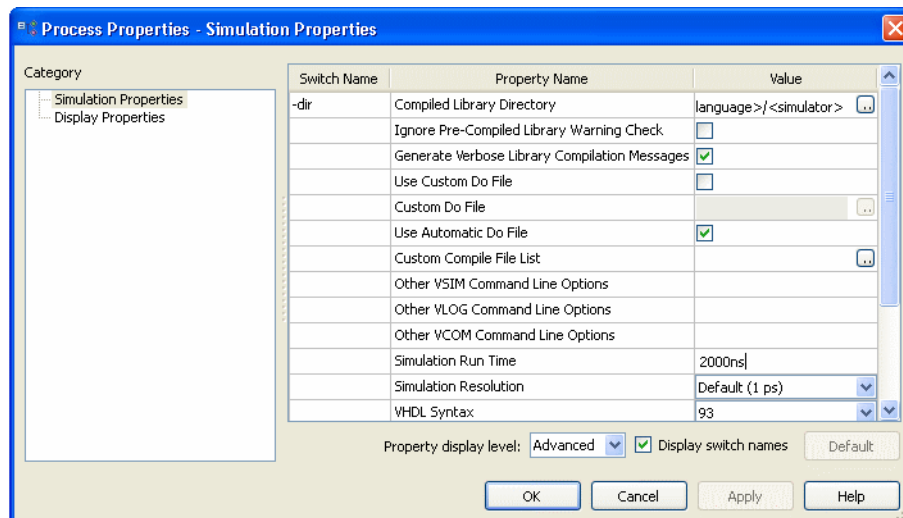

Figure 5-3: Behavioral Simulation Process Properties

- Click **OK**.

**Note:** For a detailed description of each property available in the Process Properties dialog box, click the **Help** button in the dialog box.



## Performing Simulation

After the process properties have been set, you are ready to run ModelSim. To start the behavioral simulation, double-click **Simulate Behavioral Model**. ModelSim creates the work directory, compiles the source files, loads the design, and performs simulation for the time specified.

The majority of this design runs at 100 Hz and would take a significant amount of time to simulate. The first outputs to transition after RESET is released are the SF\_D and LCD\_E control signals, at around 33 ms. This is why the counter may seem like it is not working in a short simulation. For the purpose of this tutorial, only the DCM signals are monitored to verify that they work correctly.

## Adding Signals

To view internal signals during the simulation, you must add them to the Wave window. The ISE software automatically adds all the top-level ports to the Wave window. Additional signals are displayed in the Signal window based on the selected structure in the Structure window.

There are two basic methods for adding signals to the Simulator Wave window:

- Drag and drop from the Signal/Object window.
- Highlight signals in the Signal/Object window, and select **Add > Wave > Selected Signals**.

The following procedure explains how to add additional signals in the design hierarchy. In this tutorial, you will be adding the DCM signals to the waveform.

If you are using ModelSim version 6.0 or higher, all the windows are docked by default. To undock the windows, click the Undock icon.



Figure 5-4: **Undock Icon**

To add additional signals in the design hierarchy, do the following:

1. In the Structure/Instance window, expand the **uut** hierarchy.

The following figure shows the Structure/Instance window for the VHDL flow. The graphics and the layout of the Structure/Instance window for a schematic or Verilog flow may be different.

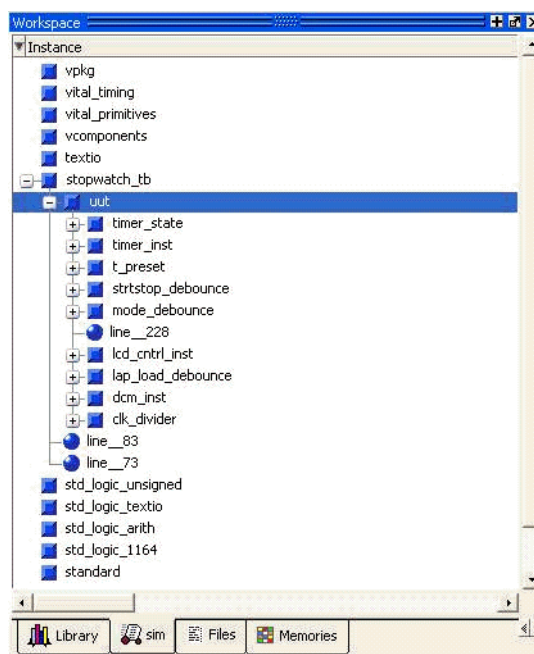

Figure 5-5: Structure/Instance Window—VHDL flow

2. Select **dcm\_inst** in the Structure/Instance window. The signals listed in the Signal/Object window are updated.
3. Click and drag **CLKIN\_IN** from the Signal/Object window to the Wave window.
4. In the Signal/Object window, select the following signals:
  - RST\_IN
  - CLKFX\_OUT
  - CLK0\_OUT
  - LOCKED\_OUT

**Note:** To select multiple signals, hold down the **Ctrl** key.

5. Right-click in the Signal/Object window.
6. Select **Add to Wave > Selected Signals**.

### Adding Dividers

In ModelSim, you can add dividers in the Wave window to make it easier to differentiate the signals. To add a divider called DCM Signals, do the following:

1. Right-click anywhere in the signal section of the Wave window. If necessary, undock the window and maximize the window for a larger view of the waveform.
2. Select **Insert Divider**.
3. Enter **DCM Signals** in the Divider Name box.
4. Click **OK**.
5. Click and drag the newly created divider to above the CLKIN\_IN signal.

After adding the DCM Signals divider, the waveform will appear as shown in the following figure.



Figure 5-6: Waveform After Adding DCM Signals Divider

The waveforms have not been drawn for any of the newly added signals. This is because ModelSim did not record the data for these signals. By default, ModelSim records data only for the signals that are added to the Wave window while the simulation is running. After new signals are added to the Wave window, you must rerun the simulation for the desired amount of time.

### Rerunning Simulation

To rerun simulation in ModelSim, do the following:

1. Click the Restart Simulation icon.



Figure 5-7: Restart Simulation Icon

- In the Restart dialog box, click **Restart**.

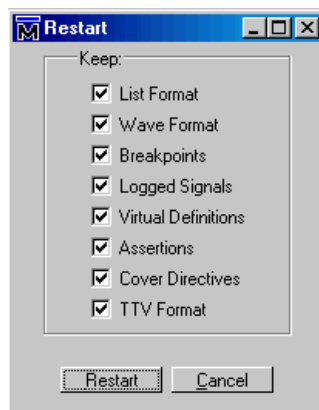

Figure 5-8: Restart Dialog Box

- At the ModelSim command prompt, enter **run 2000 ns**.
- Press **Enter**.

```
VSIM 5> run 2000 ns
```

Figure 5-9: Entering the Run Command

The simulation runs for 2000 ns. The waveforms for the DCM are now visible in the Wave window.

## Analyzing the Signals

The DCM signals can be analyzed to verify that they work as expected. The CLK0\_OUT must be 50 MHz and the CLKFX\_OUT should be approximately 26 MHz. The DCM outputs are valid only after the LOCKED\_OUT signal is high; therefore, the DCM signals are analyzed only after the LOCKED\_OUT signal has gone high.

ModelSim enables you to add cursors to measure the distance between signals. To measure the CLK0\_OUT, do the following:

- Select **Add > Wave > Cursor** twice to add two cursors.
- Click and drag one cursor to the first rising edge transition on the CLK0\_OUT signal after the LOCKED\_OUT signal has gone high.
- Click and drag the second cursor just to the right of the first.
- Click the **Find Next Transition** icon twice to move the cursor to the next rising edge on the CLK0\_OUT signal.



Figure 5-10: Find Next Transition Icon

5. Look at the bottom of the waveform for the distance between the two cursors.  
The measurement should read 20000 ps. This converts to 50 MHz, which is the input frequency from the test bench, which in turn should be the DCM CLK0 output.
6. Measure CLKFX\_OUT using the same steps as above. The measurement should read 38462 ps. This comes out to approximately 26 MHz.

## Saving the Simulation

The ModelSim simulator enables you to save the signals list in the Wave window after new signals or stimuli are added, and after simulation is rerun. The saved signals list can easily be opened each time the simulation is started.

To save the signals list, do the following:

1. In the Wave window, select **File > Save as**.
2. In the Save Format dialog box, rename the file name from the default `wave.do` to `dcm_signal.do`.
3. Click **Save**.

After restarting the simulation, select **File > Load** in the Wave window to load this file.

Your behavioral simulation is complete. To implement the design, follow the steps in [Chapter 6, Design Implementation](#).

## Behavioral Simulation Using ISim

Follow this section of the tutorial if you have skipped the previous section, [Behavioral Simulation Using ModelSim](#).

Now that you have a test bench in your project, you can perform behavioral simulation on the design using ISim. The ISE software has full integration with ISim. The ISE software enables ISim to create the work directory, compile the source files, load the design, and perform simulation based on simulation properties.

To select ISim as your project simulator, do the following:

1. In the Hierarchy pane of the Project Navigator Design panel, right-click the device line (xc3s700A-4fg484), and select **Design Properties**.
2. In the Design Properties dialog box, set the Simulator field to **ISim (VHDL/Verilog)**.

## Locating the Simulation Processes

The simulation processes in the ISE software enable you to run simulation on the design using ISim. To locate the ISim processes, do the following:

1. In the View pane of the Project Navigator Design panel, select **Simulation**, and select **Behavioral** from the drop-down list.
2. In the Hierarchy pane, select the test bench file (`stopwatch_tb`).
3. In the Processes pane, expand **ISim Simulator** to view the process hierarchy.

The following simulation processes are available:

- **Check Syntax**  
This process checks for syntax errors in the test bench.
- **Simulate Behavioral Model**  
This process starts the design simulation.

## Specifying Simulation Properties

You will perform a behavioral simulation on the stopwatch design after you set process properties for simulation.

The ISE software allows you to set several ISim properties in addition to the simulation netlist properties. To see the behavioral simulation properties and to modify the properties for this tutorial, do the following:

1. In the Hierarchy pane of the Project Navigator Design panel, select the test bench file (`stopwatch_tb`).
  2. In the Processes pane, expand **ISim Simulator**, right-click **Simulate Behavioral Model**, and select **Process Properties**.
  3. In the Process Properties dialog box, set the Property display level to **Advanced**.  
This global setting enables you to see all available properties.
- Note:** For a detailed description of each property available in the Process Property dialog box, click the **Help** button.
4. Change the Simulation Run Time to **2000 ns**.
  5. Click **OK**.

The following figure shows the properties for behavioral simulation.

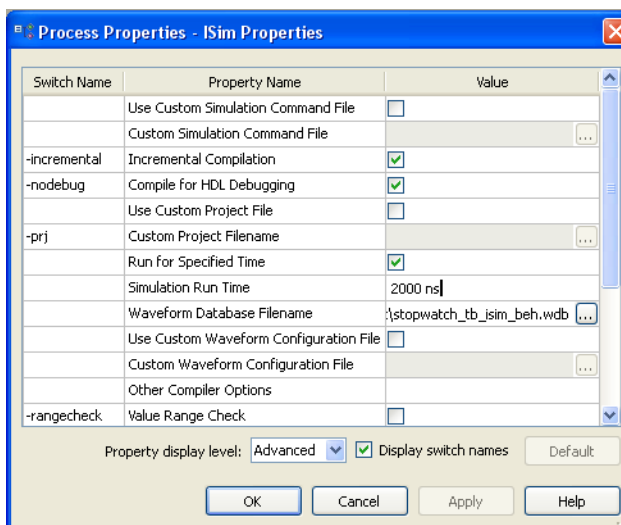

Figure 5-11: Behavioral Simulation Process Properties

## Performing Simulation

After the process properties have been set, you are ready to run ISim to simulate the design. To start the behavioral simulation, double-click **Simulate Behavioral Model**. ISim

creates the work directory, compiles the source files, loads the design, and performs simulation for the time specified.

The majority of this design runs at 100 Hz and would take a significant amount of time to simulate. The first outputs to transition after RESET is released are SF\_D and LCD\_E at around 33 ms. This is why the counter may seem like it is not working in a short simulation. For the purpose of this tutorial, only the DCM signals are monitored to verify that they work correctly.

## Adding Signals

To view signals during the simulation, you must add them to the Waveform window. The ISE software automatically adds all the top-level ports to the Waveform window. Additional signals are displayed in the Instances and Processes panel. The following procedure explains how to add additional signals in the design hierarchy. For the purpose of this tutorial, add the DCM signals to the waveform.

To add additional signals in the design hierarchy, do the following:

1. In the Instances and Processes panel, expand **stopwatch\_tb**, and expand **UUT**.

The following figure shows the contents of the Instances and Processes panel for the VHDL flow. The graphics and the layout of the window for a schematic or Verilog flow may be different.

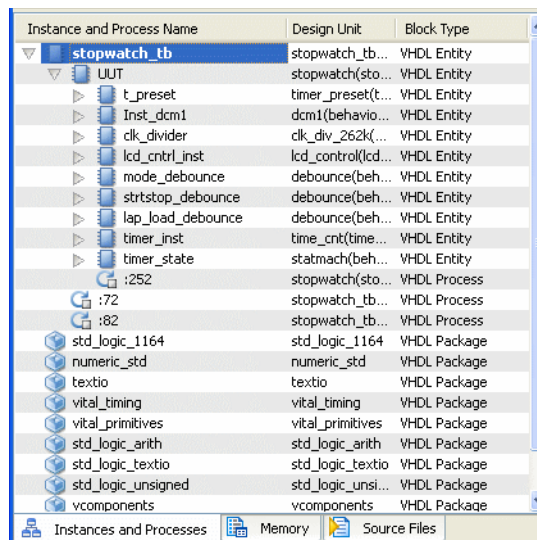

Figure 5-12: Simulation Hierarchy—VHDL flow

2. In the Instances and Processes panel, select **Inst\_dcm1**.
3. Click and drag **CLKIN\_IN** from the Simulation Objects window to the Waveform window.
4. Select the following signals:
  - RST\_IN
  - CLKFX\_OUT
  - CLK0\_OUT
  - LOCKED\_OUT

**Note:** To select multiple signals, press the **Ctrl** key.

5. Drag all the selected signals to the waveform.

**Note:** Alternatively, right-click on a selected signal and select **Add to Wave Window**.

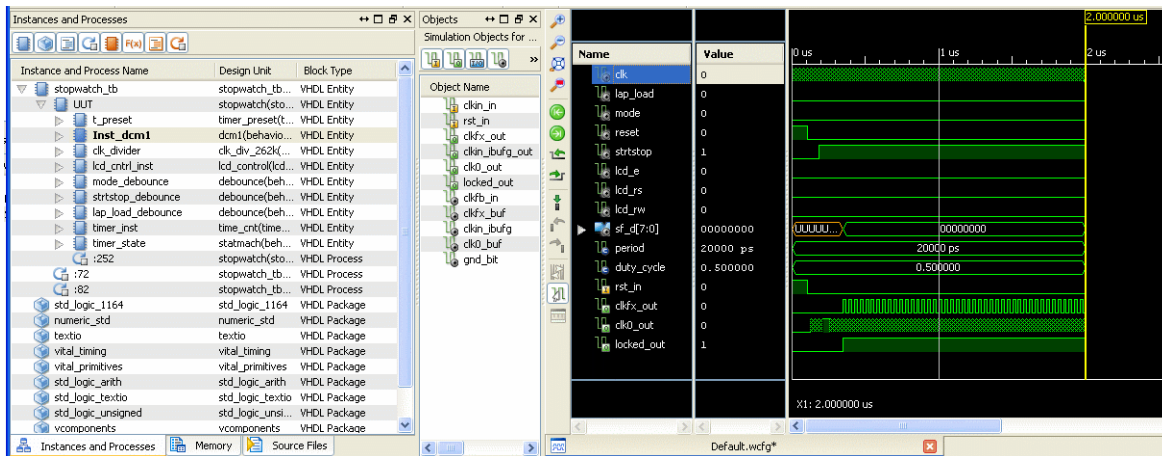

Figure 5-13: Adding Signals to the Simulation Waveform

Notice that the waveforms have not been drawn for the newly added signals. This is because ISim did not record the data for these signals. By default, ISim records data only for the signals that are added to the waveform window while the simulation is running. Therefore, when new signals are added to the waveform window, you must rerun the simulation for the desired amount of time.

## Rerunning Simulation

To rerun the simulation in ISim, do the following:

1. Click the **Restart Simulation** icon.



Figure 5-14: ISim Restart Simulation Icon

2. At the ISim command prompt in the Console, enter **run 2000 ns** and press **Enter**.

The simulation runs for 2000 ns. The waveforms for the DCM are now visible in the Waveform window.

## Analyzing the Signals

Now the DCM signals can be analyzed to verify that they work as expected. The CLK0\_OUT must be 50 MHz and the CLKFX\_OUT should be approximately 26 MHz. The DCM outputs are valid only after the LOCKED\_OUT signal is high; therefore, the DCM signals are analyzed only after the LOCKED\_OUT signal has gone high.



ISim can add markers to measure the distance between signals. To measure the CLK0\_OUT, do the following:

1. If necessary, zoom in on the waveform using the local Zoom toolbar buttons.
2. In the local waveform viewer toolbar, click the Snap to Transition toolbar button.



Figure 5-15: Snap to Transition Toolbar Button

3. Click on the first rising edge transition on the CLK0\_OUT signal after the LOCKED\_OUT signal has gone high, then drag the cursor to the right to the next rising edge transition of the CLK0\_OUT signal.
4. At the bottom of the waveform window, the start point time, end point time, and delta times are shown. The delta should read 20.0 ns. This converts to 50 MHz which is the input frequency from the test bench, which in turn is the DCM CLK0 output.

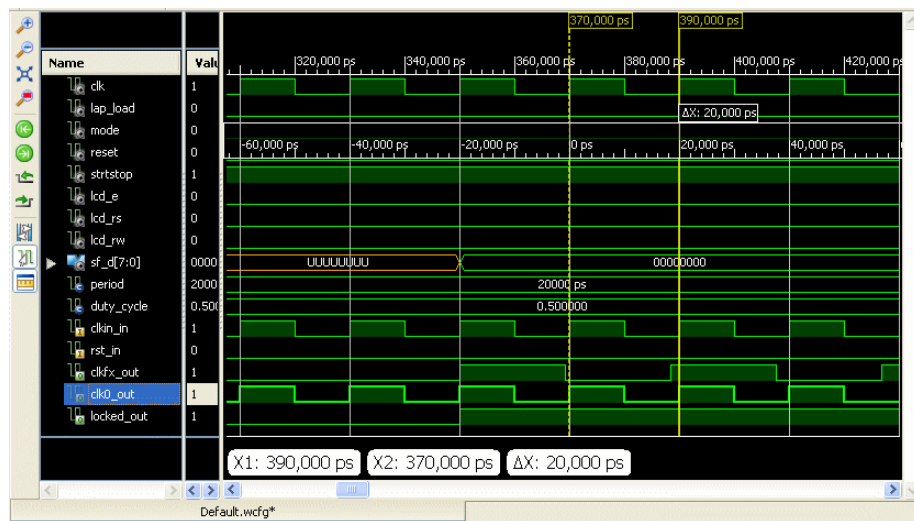

Figure 5-16: Waveform Viewer Displaying Time Between Transitions

5. Measure CLKFX\_OUT using the same steps as above. The measurement should read 38.5 ns. This equals approximately 26 MHz.

Your behavioral simulation is complete. To implement the design, follow the steps in [Chapter 6, Design Implementation](#).



# Design Implementation

---

## Overview of Design Implementation

Design implementation is the process of translating, mapping, placing, routing, and generating a bitstream file for your design. The design implementation tools are embedded in the Xilinx® ISE® software for easy access and project management.

This chapter is the first in the [Implementation-Only Flow](#) and is a subsequent chapter for the [HDL Design Flow](#) and the [Schematic Design Flow](#).

This chapter demonstrates the ISE software implementation flow. The front-end design has already been compiled in an EDA interface tool. For details about compiling the design, see [Chapter 3, HDL-Based Design](#) or [Chapter 4, Schematic-Based Design](#). In this chapter, you will be passing a synthesized netlist (EDN, NGC) from the front-end tool to the back-end design implementation tools, and you will be incorporating placement constraints through a User Constraints File (UCF). You will also add timing constraints as well as additional placement constraints.

## Getting Started

The tutorial design emulates a runner's stopwatch with actual and lap times. There are five inputs to the system: CLK, RESET, LAP\_LOAD, MODE, and SRTSTP. This system generates a traditional stopwatch with lap times and a traditional timer on an LCD display.

## Continuing from Design Entry

If you have followed the tutorial using either the HDL design flow or the schematic design flow, you have created a project, completed source files, and synthesized the design.

If you do not have a `stopwatch.ucf` constraint file in your project, create one as follows:

1. In the Hierarchy pane of the Project Navigator Design panel, select the top-level source file `stopwatch`.
2. Select **Project > New Source**.
3. Select **Implementation Constraints File**.
4. Enter `stopwatch.ucf` as the file name.
5. Click **Next**.
6. Click **Finish**.

With a UCF in the project, you are now ready to begin this chapter. Skip to the [Specifying Options](#) section.

## Starting from Design Implementation

If you are beginning the tutorial from this chapter, you will need to download the pre-synthesized design files provided on the Xilinx website, create a project in the ISE software, and then add the downloaded source files to the project.

1. Create an empty working directory named **Watch**.
2. Copy the pre-synthesized tutorial files shown in the following table to your newly created working directory. The files are provided with the ISE Design Suite [Tutorials](#) available from the Xilinx website.

**Table 6-1: Required Tutorial Files**

File Name	Description
stopwatch.edn, stopwatch.edf or stopwatch.ngc	Input netlist file (EDIF)
timer_preset.ngc	Timer netlist file (NGC)
stopwatch.ucf	User Constraints File

3. Open the ISE software using one of the following methods:
  - a. On a workstation, enter **ise**.
  - b. On a PC, select **Start > Programs > Xilinx ISE Design Suite > ISE Design Tools > Project Navigator**.
4. Create a new project, and add the EDIF netlist as follows:
  - a. Select **File > New Project**.
  - b. In the Name field, enter **wtut\_edif**.
  - c. Select **EDIF** for the Top-Level Source Type, and click **Next**.
  - d. Select **stopwatch.edf** or **stopwatch.edn** for the Input Design file.
  - e. Select **stopwatch.ucf** for the Constraints file, and click **Next**.
  - f. Select the following values:
    - Family: **Spartan3A and Spartan3AN**
    - Device: **XC3S700A**
    - Package: **FG484**
    - Speed: **-4**
  - g. Click **Next**, then **Finish** to complete the project creation.

**Note:** If the `timer_preset.ngc` file is not in the project directory, copy it from the extracted ZIP file.

## Specifying Options

This section describes how to set process properties for design implementation. The implementation properties control how the software maps, places, routes, and optimizes a design.

To set the implementation properties for this tutorial, do the following:

1. In the View pane of the Project Navigator Design panel, select **Implementation**.
2. In the Hierarchy pane, select the `stopwatch` top-level file.
3. In the Processes pane, right-click the **Implement Design** process, and select **Process Properties**.

The Process Properties dialog box provides access to the Translate, Map, Place and Route, and Timing Report properties. In the left pane of the dialog box, you can click the different categories to set properties for each design implementation phase.

4. Ensure that you have set the Property display level to **Advanced**.

This global setting enables you to see all available properties.

5. Click the **Place & Route Properties** category.

6. Change the Place & Route Effort Level (Overall) to **High**.

This option increases the overall effort level of Place and Route during implementation.

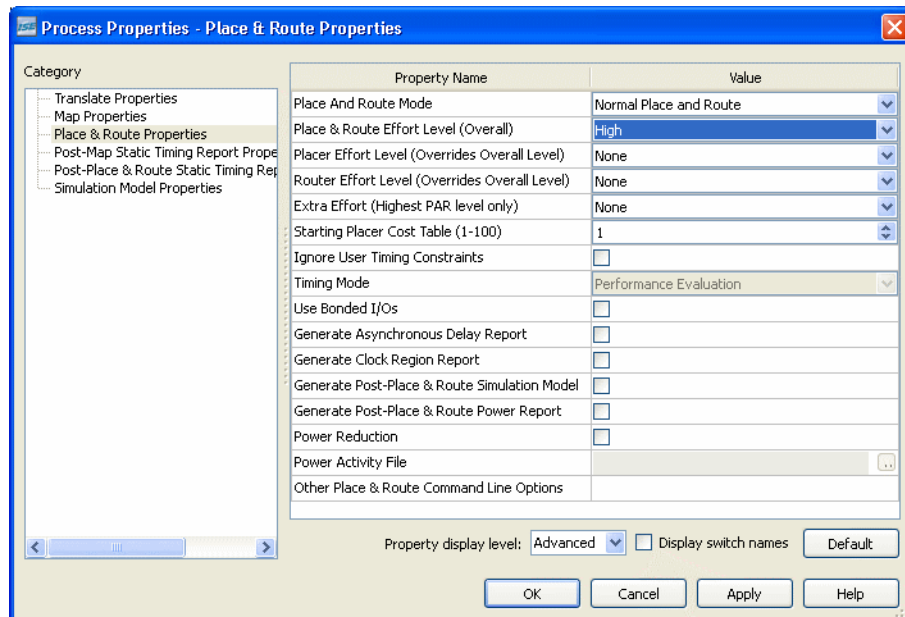

Figure 6-1: Place and Route Properties

7. Click **OK** to exit the Process Properties dialog box.

## Creating Timing Constraints

The User Constraints File (UCF) is a text file and can be edited directly with a text editor. To facilitate editing of this file, graphical tools are provided to create and edit constraints. The Constraints Editor and PlanAhead™ software are graphical tools that enable you to enter timing and I/O and placement constraints.

To launch the Constraints Editor, do the following:

1. In the Hierarchy pane of the Project Navigator Design panel, select the `stopwatch` module.
2. In the Processes pane, expand **User Constraints**, and double-click **Create Timing Constraints**.

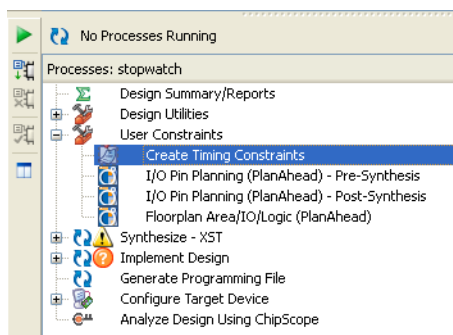

Figure 6-2: Create Timing Constraints Process

This automatically runs the Translate step, which is discussed in the following section. Then, the Constraints Editor opens.

## Translating the Design

The ISE software manages the files created during implementation. The ISE design tools use the settings that you specified in the Process Properties dialog box. This gives you complete control over how a design is processed. Typically, you set your properties first. You then run through the entire flow by running the Implement Design process. The Implement Design process includes the three sub-processes: Translate, Map, and Place and Route. You can simply run the Implement Design process to automate the running of all three sub-processes, or you can run the sub-processes individually. In this tutorial you will run the sub-processes individually to more easily see and understand each step.

During translation, the NGDBuild program performs the following functions:

- Converts input design netlists and writes results to a single merged NGD netlist. The merged netlist describes the logic in the design as well as any location and timing constraints.
- Performs timing specification and logical design rule checks.
- Adds constraints from the User Constraints File (UCF) to the merged netlist.

## Using the Constraints Editor

When you run the Create Timing Constraints process, Translate is automatically run and the ISE software launches the Constraints Editor.

The Constraints Editor enables you to do the following:

- Edit constraints previously defined in a UCF file.
- Add new constraints to your design.

Following are input files to the Constraints Editor:

- NGD (Native Generic Database) File

The NGD file serves as input to the mapper, which then outputs the physical design database, an NCD (Native Circuit Description) file.

- Corresponding UCF (User Constraint File)

All UCF files that are part of the ISE project are passed to Constraints Editor.

Multiple UCF files are supported in ISE projects. All constraint files in the project are read by the Constraints Editor, and constraints that you edit are updated in the originating constraint file. New constraints are written to the UCF file specified in Constraints Editor.

The Translate step (NGDBuild) uses the UCF file, along with design source netlists, to produce a newer NGD file, which incorporates the changes made. The Map program (the next section in the design flow) then reads the NGD. In this design, the `stopwatch.ngd` and `stopwatch.ucf` files are automatically read into the Constraints Editor.

In the following section, a PERIOD, Global OFFSET IN, Global OFFSET OUT, and TIMEGRP OFFSET IN constraint will be created and written in the UCF and used during implementation. The Clock Domains branch of the Timing Constraints tab automatically displays all the clock nets in your design, and enables you to define the associated period, pad to setup, and clock to pad values. Note that many of the internal names will vary depending on the design flow and synthesis tool used.

The following figure shows the Constraints Editor.

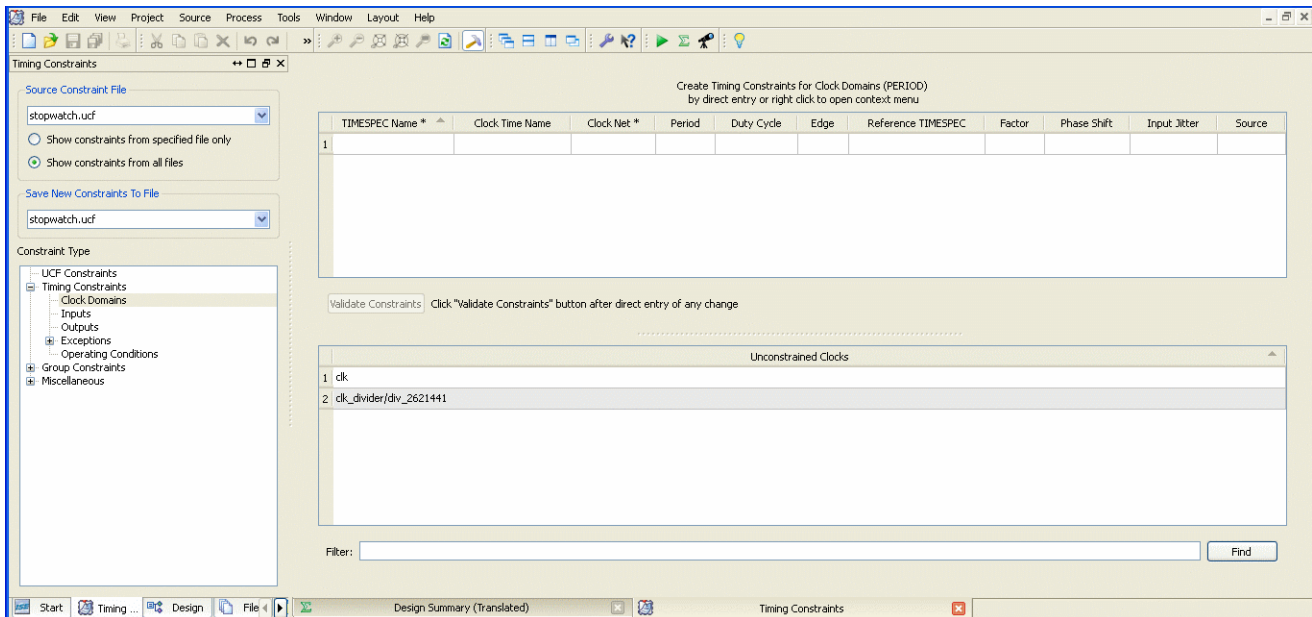

Figure 6-3: Constraints Editor in Project Navigator—Clock Domains

In the Constraints Editor, edit the constraints as follows:

1. Double-click the row containing the **clk** signal in the Unconstrained Clocks table. The Clock Period dialog box opens.
2. For the Clock Signal Definition, verify that **Specify Time** is selected. This enables you to define an explicit period for the clock.
3. Enter a value of **7.0** in the Time field.
4. Verify that **ns** is selected from the Units drop-down list.

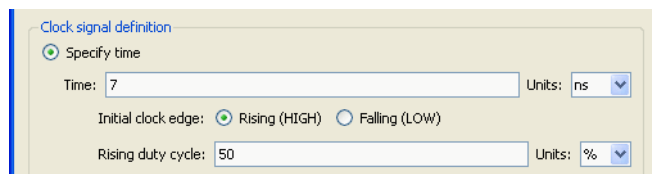

Figure 6-4: PERIOD Constraint Values

5. For the Input Jitter section, enter a value of **60** in the Time field.
6. Verify that **ps** is selected from the Units drop-down list.

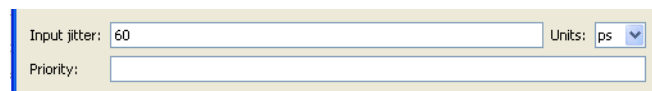

Figure 6-5: INPUT JITTER Constraint Value

7. Click **OK**.



The period constraint is displayed in the constraint table at the top of the window. The period cell is updated with the global clock period constraint that you just defined (with a default 50% duty cycle).

8. Select the **Inputs** branch under Timing Constraints in the Constraint Type tree view.
9. Double-click on the **clk** signal in the Global OFFSET IN Constraint table to bring up the Create Setup Time (OFFSET IN) wizard.
10. Keep the default values on the first page of the screen, and click **Next**.

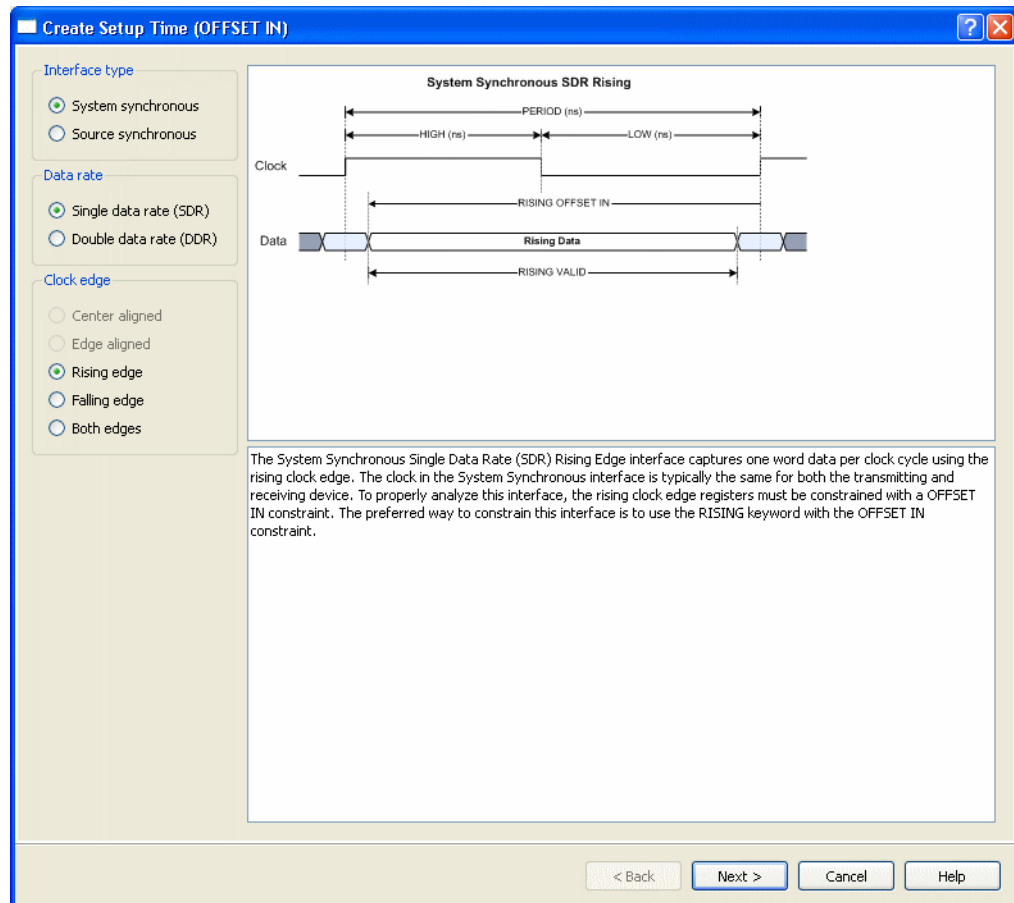

Figure 6-6: Offset In Constraint—Page 1

11. In the External setup time (offset in) field, enter **6 ns**.
  12. In the Data valid duration field, enter **6 ns**.
- This creates a Global OFFSET IN constraint for the CLK signal.

13. Click **Finish**.

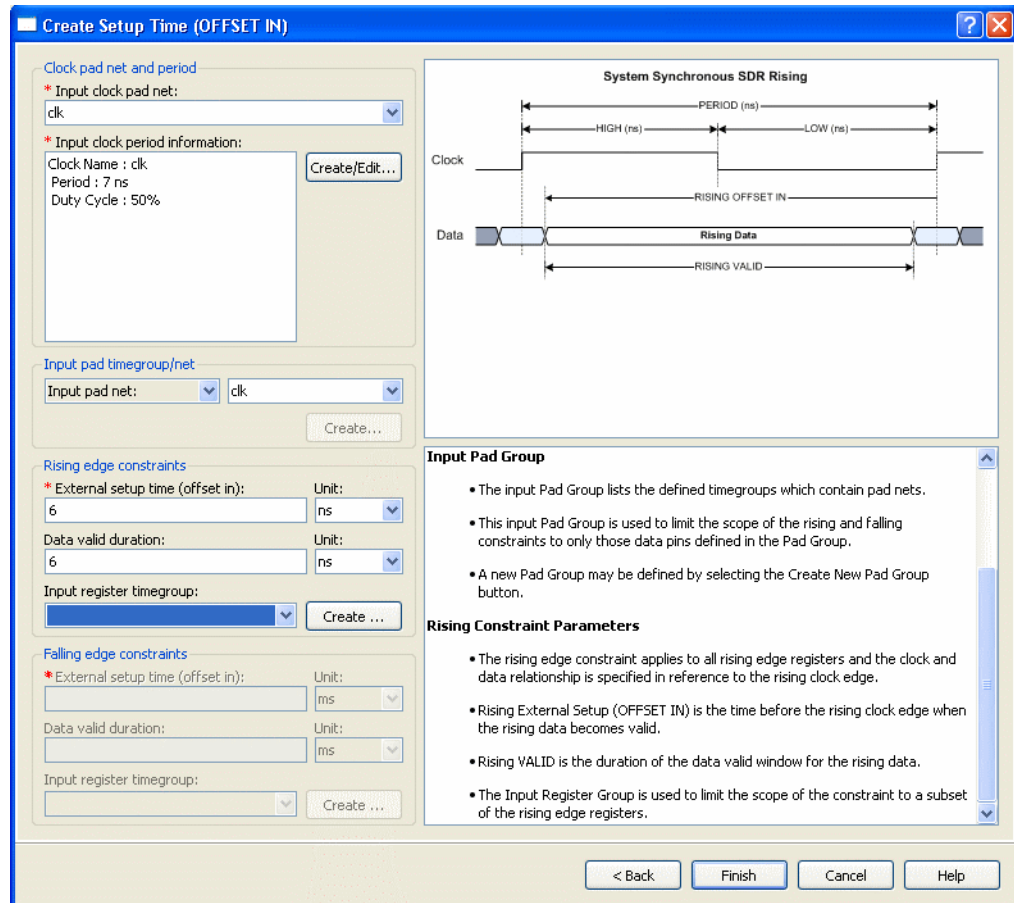

Figure 6-7: Offset In Constraint—Page 2

14. Select the **Outputs** branch under Timing Constraints in the Constraint Type tree view.
15. Double-click the **clk** signal in the Global OFFSET OUT Constraint table.
16. In the External clock to pad (offset out) field, enter a value of **38 ns**.  
This creates a Global OFFSET OUT constraint for the CLK signal.

17. Click **OK**.

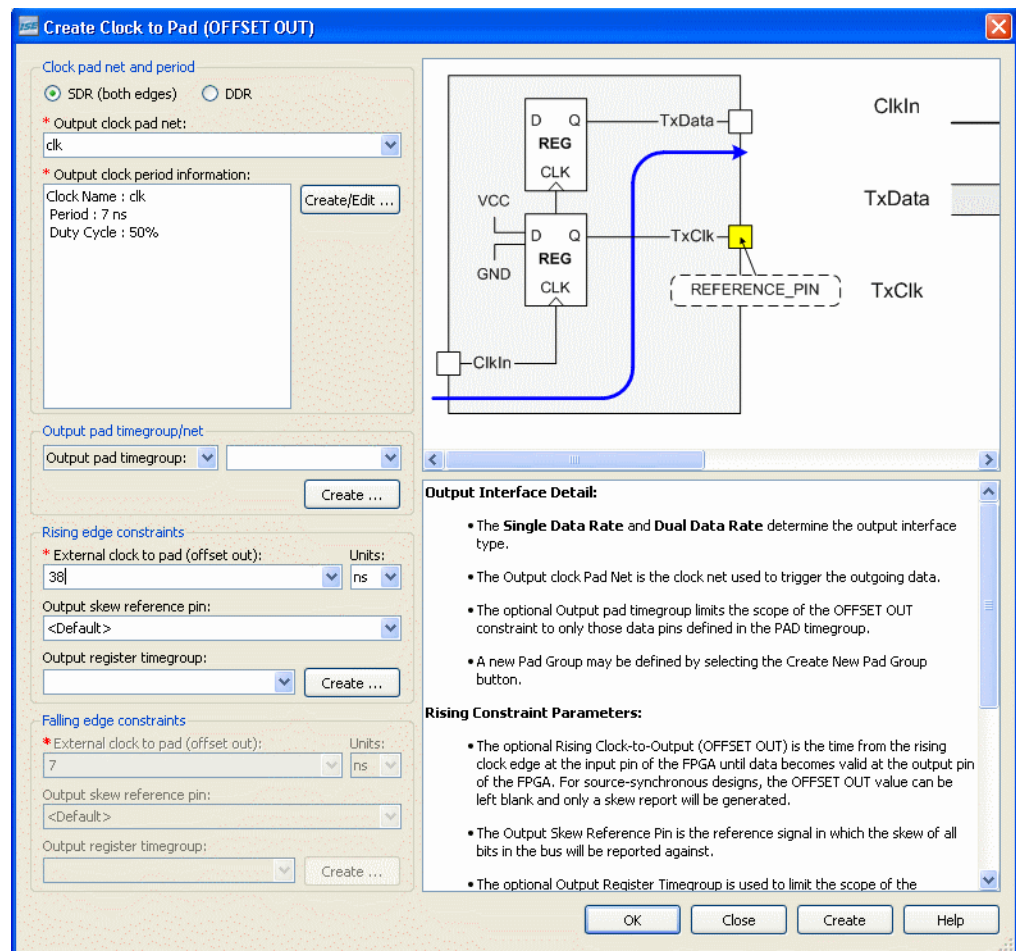

Figure 6-8: Offset Out Constraint

18. In the Unconstrained Output Ports table, select the **sf\_d<0>** through **sf\_d<7>** signals using **Shift+Click** to select multiple rows.
19. Right-click, and select **Create Time Group**.

20. In the Create Time Group dialog, type **display\_grp** for the Time group name, then click **OK**.

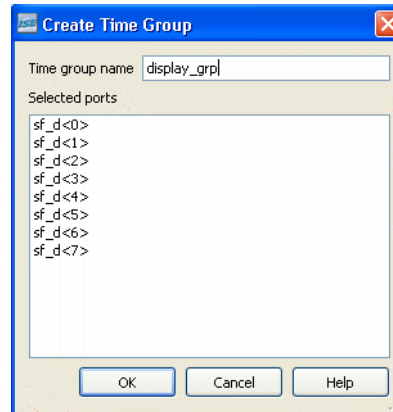

Figure 6-9: **Creating a Time Group**

21. When asked if you would like to create an offset constraint, click **OK**.
22. In the External clock to pad (offset out) field, enter **32 ns**.

23. Click **OK**.

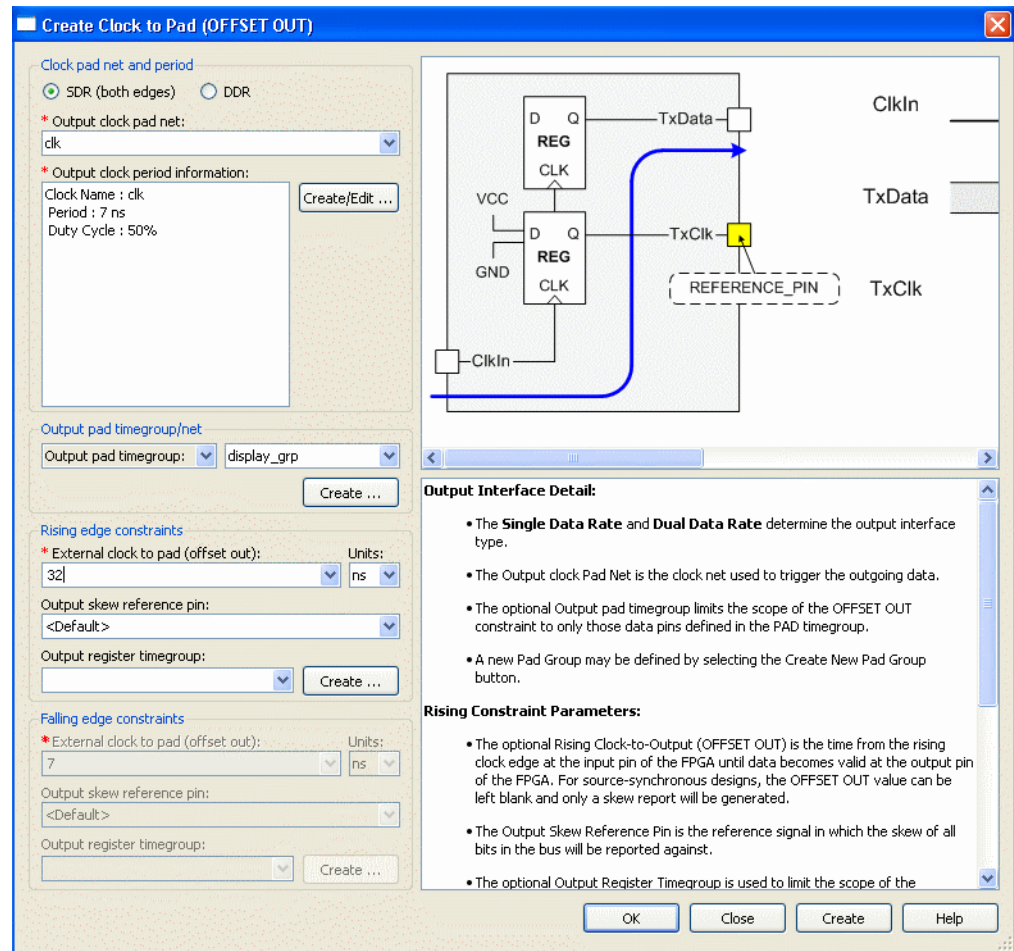

Figure 6-10: Clock to Pad Dialog Box

24. Select **File > Save** in the Constraints Editor.

The changes are now saved in the `stopwatch.ucf` file in your current working directory.

25. To close the Constraints Editor, select **File > Close**.

## Assigning I/O Locations Using PlanAhead Software

Use the PlanAhead software to add and edit the pin locations and area group constraints defined in the NGD file. The PlanAhead software writes the constraints to the project UCF file. In the case of multiple UCF files in the project, you will be asked to specify the constraint file in which to write new constraints. If you modify existing constraints, the constraints will be written to the constraint file in which they originated. The PlanAhead software also provides device-specific design rule checks to aid you in pin planning and placement.

The Translate step uses the design UCF file, along with the design source netlists, to produce a newer NGD file. The NGD file incorporates the changes made in the design and the UCF file from the previous section.

This section describes the creation of IOB assignments for several signals:

1. In the Hierarchy pane of the Project Navigator Design panel, select the `stopwatch` module.
2. In the Processes pane, expand **User Constraints**, and double-click **I/O Pin Planning (PlanAhead) - Post-Synthesis**.

I/O pin planning can be performed either pre- or post-synthesis. Whenever possible, it is recommended that the process be run post-synthesis, because the design then contains information needed for I/O- and clock-related design rule checks performed by the PlanAhead software.

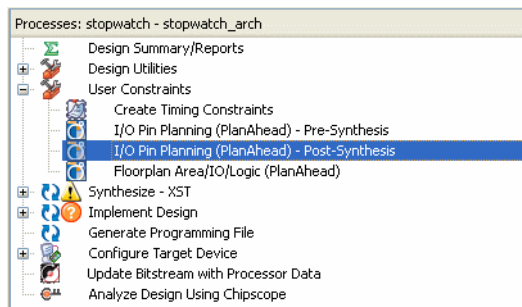

Figure 6-11: I/O Pin Planning—Post-Synthesis

This process launches the PlanAhead software. If the design has not yet completed synthesis, Project Navigator will first automatically run synthesis before launching the PlanAhead software for I/O pin planning.

The Welcome to PlanAhead software screen provides links to detailed documentation, tutorials, and other training material to help you learn more about the PlanAhead software. The tutorials provide an overview of the use and capabilities of the PlanAhead software.

- Click **Close** on the Welcome dialog to proceed in the PlanAhead software.

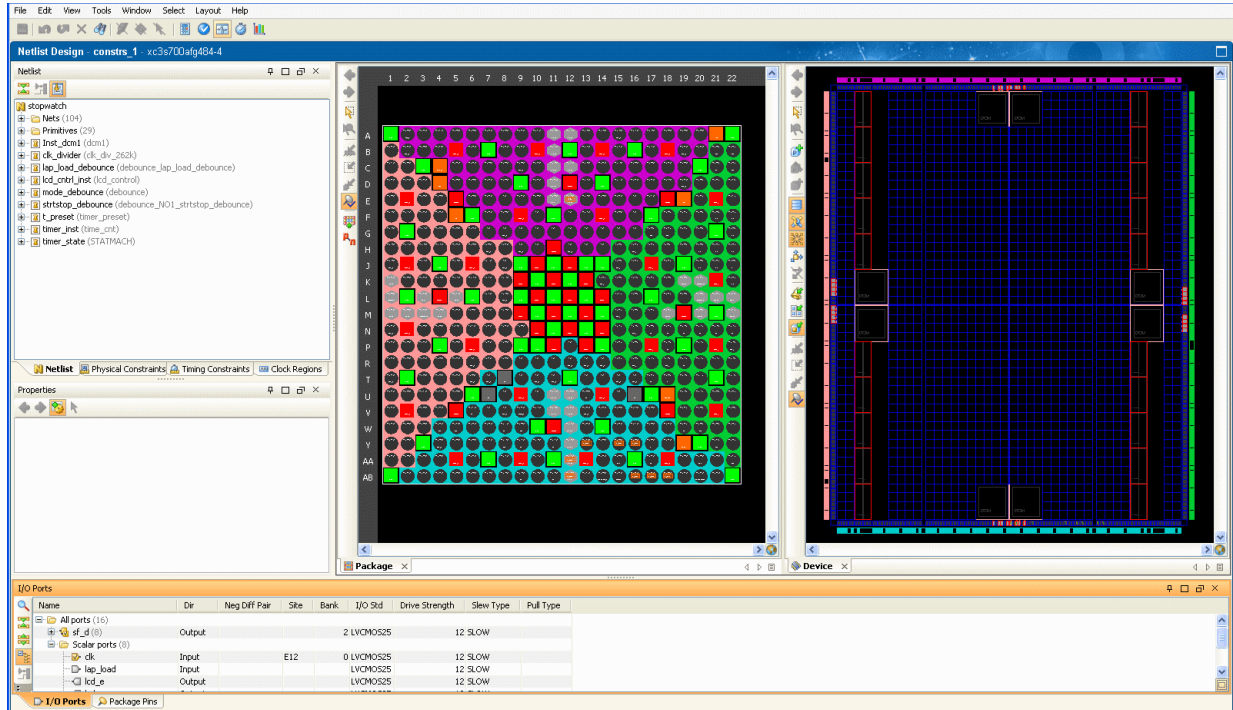

Figure 6-12: PlanAhead Software for I/O Planning

- In the I/O Ports tab, expand the **Scalar Ports** tree under All ports. You will now create pin assignments for the `lcd_e`, `lcd_rs`, and `lcd_rw` I/O signals.
- Locate the **lcd\_e** output signal, then click and drag it into the Package view and drop it on the **AB4** pin location.

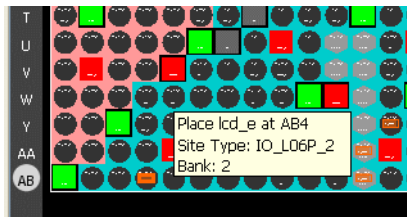

Figure 6-13: Assigning I/O Pins by Dragging into Package View

- Repeat the previous step to place the following additional output pins:
  - LCD\_RS: Y14
  - LCD\_RW: W13

Alternatively, you can type the location in the Site field in the I/O Port Properties tab when the I/O signal is selected.

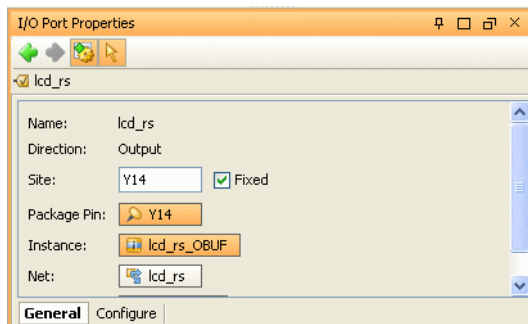

Figure 6-14: Assigning I/O Pins Using I/O Port Properties

7. Using either the drag and drop or Port Properties method, place the following input signals onto the appropriate I/O pin locations:
  - LAP\_LOAD: T16
  - RESET: U15
  - MODE: T14
  - STRTSTOP: T15
8. After the pins are locked down, select **File > Save Project**. The changes are saved in the `stopwatch.ucf` file.
9. To exit the PlanAhead software, select **File > Exit**.

## Mapping the Design

Now that the implementation properties and constraints have been defined, continue with the implementation of the design as follows:

1. In the Hierarchy pane of the Project Navigator Design panel, select the `stopwatch` module.
2. In the Processes pane, expand **Implement Design**, and double-click **Map**.

If the Translate process is not up-to-date, Project Navigator automatically runs that process as well.

The design is mapped into CLBs and IOBs. Map performs the following functions:

- Allocates CLB and IOB resources for all basic logic elements in the design.
- Processes all location and timing constraints, performs target device optimizations, and runs a design rule check on the resulting mapped netlist.



Each step generates its own report as shown in the following table.

Table 6-2: Reports Generated by Translate and Map

Report	Description
<b>Translation Report</b>	Includes warning and error messages from the translation process.
<b>Map Report</b>	Includes information about how the target device resources are allocated, references to trimmed logic, and device utilization.
<b>All NGDBuild and Map Reports</b>	For detailed information on the Map reports, refer to the <i>Command Line Tools User Guide (UG628)</i> . This guide is available from the ISE Software Manuals collection, automatically installed with your ISE software. To open the Software Manuals collection, select <b>Help &gt; Software Manuals</b> . The <a href="#">Software Manuals</a> collection is also available from the Xilinx website.

To view a report, do the following:

1. In the Processes pane of the Project Navigator Design panel, double-click **Design Summary/Reports**.

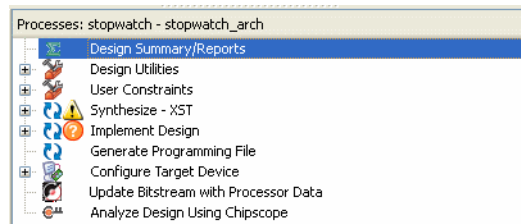
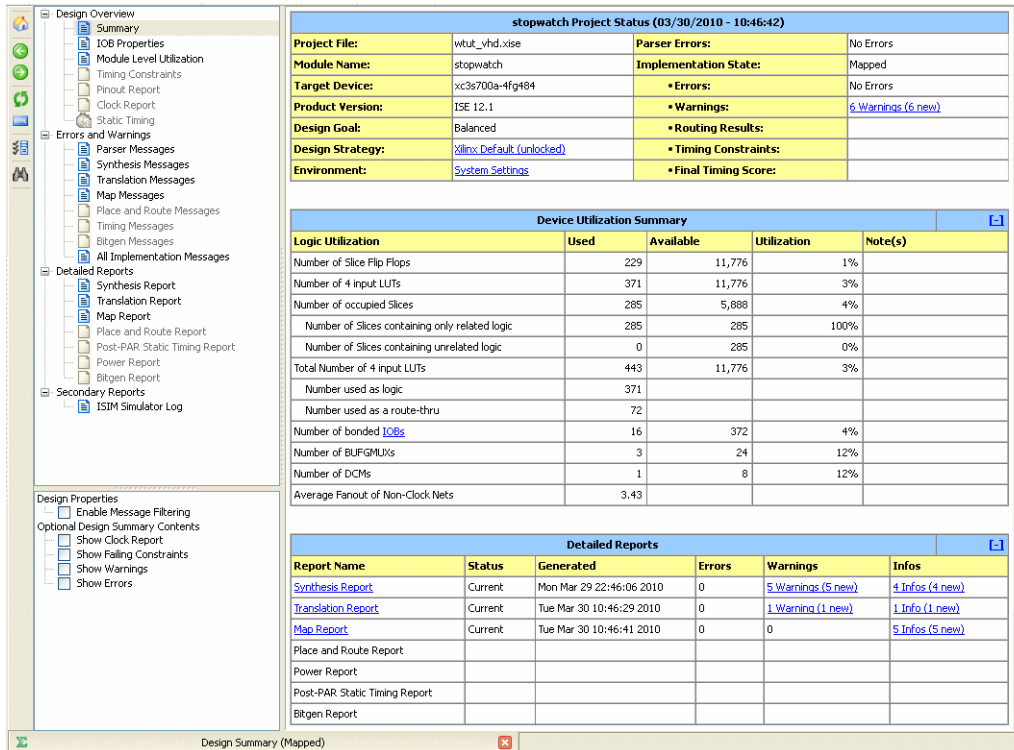

Figure 6-15: Opening the Design Summary/Reports

The following figure shows the Design Summary/Report Viewer.



**stopwatch Project Status (03/30/2010 - 10:46:42)**

<b>Project File:</b>	wtut_vhd.xise	<b>Parser Errors:</b>	No Errors
<b>Module Name:</b>	stopwatch	<b>Implementation State:</b>	Mapped
<b>Target Device:</b>	xc3s700a-4fg484	<b>Errors:</b>	No Errors
<b>Product Version:</b>	ISE 12.1	<b>Warnings:</b>	6 Warnings (6 new)
<b>Design Goal:</b>	Balanced	<b>Routing Results:</b>	
<b>Design Strategy:</b>	Xilinx Default (Unlocked)	<b>Timing Constraints:</b>	
<b>Environment:</b>	System Settings	<b>Final Timing Score:</b>	

**Device Utilization Summary**

Logic Utilization	Used	Available	Utilization	Note(s)
Number of Slice Flip Flops	229	11,776	1%	
Number of 4 input LUTs	371	11,776	3%	
Number of occupied Slices	285	5,888	4%	
Number of Slices containing only related logic	285	285	100%	
Number of Slices containing unrelated logic	0	285	0%	
Total Number of 4 input LUTs	443	11,776	3%	
Number used as logic	371			
Number used as a route-thru	72			
Number of bonded IOBs	16	372	4%	
Number of BUFGMUXs	3	24	12%	
Number of DCMs	1	8	12%	
Average Fanout of Non-Clock Nets	3.43			

**Detailed Reports**

Report Name	Status	Generated	Errors	Warnings	Infos
<a href="#">Synthesis Report</a>	Current	Mon Mar 29 22:46:06 2010	0	5 Warnings (5 new)	4 Infos (4 new)
<a href="#">Translation Report</a>	Current	Tue Mar 30 10:46:29 2010	0	1 Warning (1 new)	1 Info (1 new)
<a href="#">Map Report</a>	Current	Tue Mar 30 10:46:41 2010	0	0	5 Infos (5 new)
Place and Route Report					
Power Report					
Post-PAR Static Timing Report					
Bitgen Report					

Figure 6-16: Design Summary/Report Viewer

- In the left pane of the Design Summary/Report Viewer, select a report such as the **Translation Report** or **Map Report** in the Detailed Reports section.
- Review the report.

The Design Summary also provides a summary of the design results, and a list of all of the messages (Errors, Warnings, Info) generated by the implementation run.

## Using Timing Analysis to Evaluate Block Delays After Mapping

After the design is mapped, evaluate the Logic Level details in the Post-Map Static Timing Report to evaluate the logical paths in the design. Evaluation verifies that block delays are reasonable given the design specifications. Because the design is not yet placed and routed, actual routing delay information is not available. The timing report describes the logical block delays and estimated routing delays. The net delays provided are based on an optimal distance between blocks (also referred to as “unplaced floors”).

### Estimating Timing Goals with the 50/50 Rule

For a preliminary indication of how realistic your timing goals are, evaluate the design after the map stage. A rough guideline (known as the “50/50 rule”) specifies that the block delays in any single path make up approximately 50% of the total path delay after the design is routed. For example, a path with 10 ns of block delay should meet a 20 ns timing constraint after it is placed and routed.

If your design is extremely dense, the Post-Map Static Timing Report provides a summary analysis of your timing constraints based on block delays and estimates of route delays. This analysis can help to determine if your timing constraints are going to be met. This report is produced after Map and prior to Place and Route (PAR).

## Reviewing the Post-Map Static Timing Report

Use the Post-Map Static Timing Report to determine timing violations that may occur prior to running PAR. Since you defined timing constraints for the stopwatch design, the timing report will display the path for each of the timing constraints.

To view the Post-Map Static Timing Report and review the PERIOD Constraints that were entered earlier, do the following:

1. In the Processes pane, expand **Map**, and double-click **Generate Post-Map Static Timing**.
2. To open the Post-Map Static Timing Report, double-click **Analyze Post-Map Static Timing**.

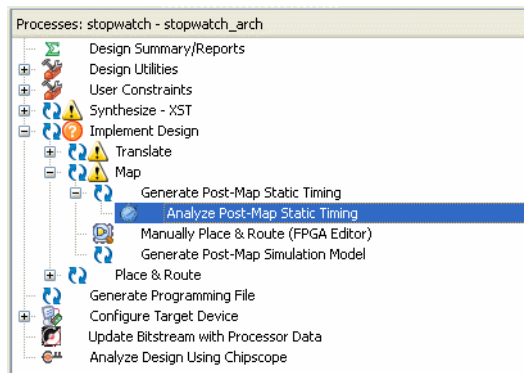

Figure 6-17: Post-Map Static Timing Report Process

Timing Analyzer automatically launches and displays the report.

3. In the Report Navigation pane, select the **TS\_inst\_dcm1\_CLKFX\_BUF** timing constraint.

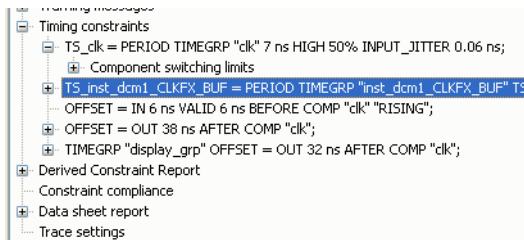

Figure 6-18: Selecting Post-Map Static Timing Constraint

The Workspace shows the report for the selected constraint. At the top of this report, you will find the selected period constraint and the minimum period obtained by the tools after mapping. By default, only three paths per timing constraint will be shown. Selecting one of the three paths allows you to see a breakdown of the path which contains the component and routing delays.

Notice that the report displays the percentage of logic versus the percentage of routing at the end of each path (e.g. 88.0% logic, 12.0% route). The unplaced floors listed are estimates (indicated by the letter “e” next to the net delay) based on optimal placement of blocks.

4. After viewing the report, close the Timing Analyzer by selecting **File > Close**.

**Note:** Even if you do not generate a timing report, PAR still processes a design based on the relationship between the block delays, floors, and timing specifications for the design. For example, if a PERIOD constraint of **8 ns** is specified for a path, and there are block delays of **7 ns** and unplaced floor net delays of **3 ns**, PAR stops and generates an error message. In this example, PAR fails because it determines that the total delay (**10 ns**) is greater than the constraint placed on the design (**8 ns**). The Post-Map Static Timing Report will list any pre-PAR timing violations.

## Placing and Routing the Design

After the mapped design is evaluated, the design can be placed and routed. One of two place-and-route algorithms is performed during the Place and Route (PAR) process:

- **Timing-Driven PAR**  
PAR is run with the timing constraints specified in the input netlist, the constraints file, or both.
- **Non-Timing-Driven PAR**  
PAR is run, ignoring all timing constraints.

Because you defined timing constraints earlier in this chapter, the Place and Route (PAR) process performs timing-driven placement and routing.

To run Place and Route, do the following:

1. In the Hierarchy pane of the Project Navigator Design panel, select the `stopwatch` module.
2. In the Processes pane, expand **Implement Design**, and double-click **Place & Route**.

The Place and Route process generates the reports shown in the following table.

**Table 6-3: Reports Generated by PAR**

Report	Description
<b>Place and Route Report</b>	Provides a device utilization and delay summary. Use this report to verify that the design successfully routed and that all timing constraints were met.
<b>Asynchronous Delay Report</b>	Lists all nets in the design and the delays of all loads on the net.
<b>All PAR Reports</b>	For detailed information on the PAR reports, refer to the <i>Command Line Tools User Guide (UG628)</i> . This guide is available from the ISE Software Manuals collection, automatically installed with your ISE software. To open the Software Manuals collection, select <b>Help &gt; Software Manuals</b> . The <a href="#">Software Manuals</a> collection is also available from the Xilinx website.

**Note:** Additional, optional Place and Route reports can also be generated by enabling their creation in the Place and Route process properties. When these reports are created, they will appear in the Design Summary in the Secondary Reports section.

To review the reports that are generated after the Place and Route process is completed, do the following:

1. In the Processes pane of the Project Navigator Design panel, double-click **Design Summary/Reports**.
2. In the left pane of the Design Summary/Report Viewer, select the **Place and Route Report** in the Detailed Reports section.

The following figure shows the Place and Route Report in the Design Summary/Report Viewer.

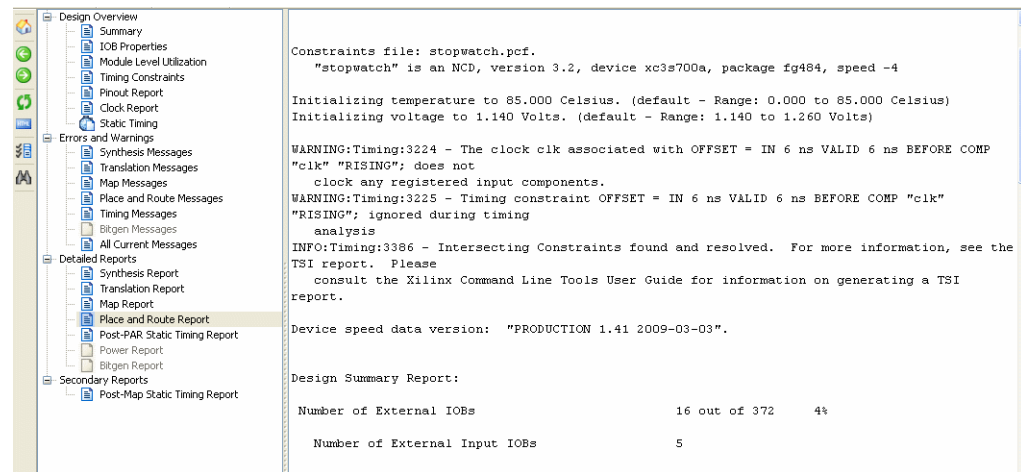

Figure 6-19: Place and Route Report

## Using FPGA Editor to Verify the Place and Route

Use the FPGA Editor to display and configure Field Programmable Gate Arrays (FPGAs).

The FPGA Editor reads and writes Native Circuit Description (NCD) files, macro files (NMC) and Physical Constraints Files (PCF).

Use FPGA Editor to do the following:

- Place and route critical components before running the automatic Place and Route tools.
- Finish placement and routing if the routing program does not completely route your design.
- Add probes to your design to examine the signal states of the targeted device. Probes are used to route the value of internal nets to an IOB (Input/Output Block) for analysis during debugging of a device.
- Run the BitGen program and download the resulting bitstream file to the targeted device.
- View and change the nets connected to the capture units of an Integrated Logic Analyzer (ILA) core in your design.

To view the actual design layout of the FPGA, do the following:

1. In the Processes pane of the Project Navigator Design panel, expand **Place & Route**, and double-click **View/Edit Routed Design (FPGA Editor)**.

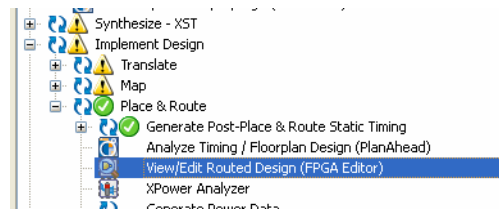

Figure 6-20: **View/Edit Routed Design (FPGA Editor) Process**

2. In FPGA Editor, change the List Window from All Components to **All Nets**. This enables you to view all of the possible nets in the design.

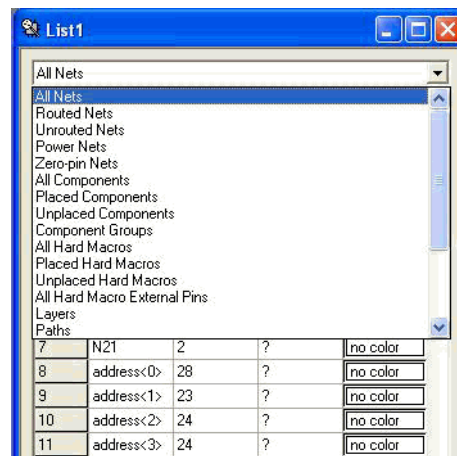

Figure 6-21: **List Window in FPGA Editor**

3. Select the **clk\_26214k** (Clock) net to see the fanout of the clock net.

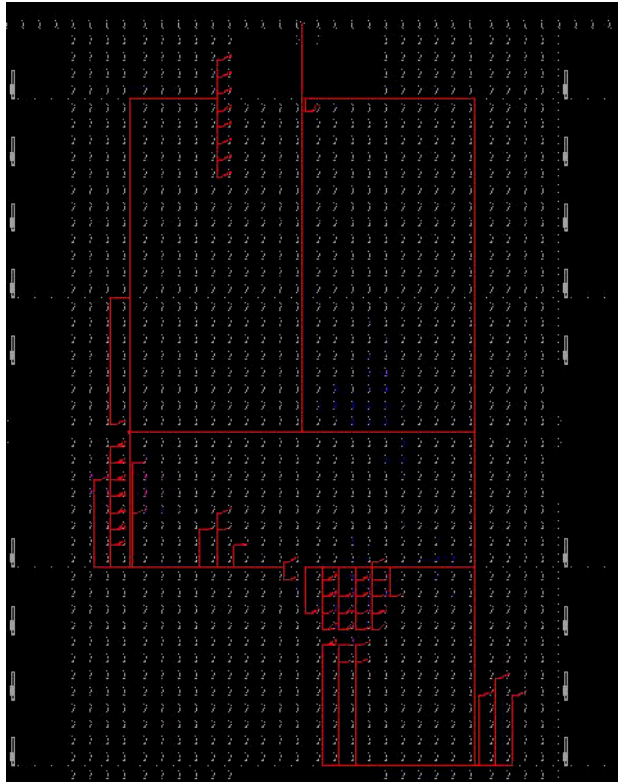

Figure 6-22: Clock Net

4. To exit FPGA Editor, select **File > Exit**.

## Evaluating Post-Layout Timing

After the design is placed and routed, you can analyze the post-Place and Route timing results to verify how the design performs against your specified timing goals.

There are multiple ways in which you can analyze timing:

- View the Post-Place and Route Static Timing Report.
- Use the PlanAhead software for post-Place and Route timing analysis.
- Use hyperlinks in the Design Summary to analyze individual timing constraints.

### Viewing the Post-Place and Route Static Timing Report

This report evaluates the logical block delays and the routing delays. The net delays are reported as actual routing delays after the Place and Route process. To display this report, do the following:

1. In the upper left pane of the Design Summary/Report Viewer, select **Static Timing** in the Design Overview section.

**Note:** Alternatively, you can run the **Analyze Post-Place & Route Static Timing** process from the Processes pane. Expand **Implement Design > Place & Route > Generate Post-Place & Route Static Timing** to access this process.

2. The Timing Report opens in Timing Analyzer.

Following is a summary of the post-Place and Route Static Timing Report for the stopwatch design:

- The minimum period value increased due to the actual routing delays.  
The post-Map timing report showed logic delays contributed to 80% to 90% of the minimum period attained. The post-layout report indicates that the logical delay value now equals between 30% and 40% of the period. The total unplaced floors estimate changed as well.
- The post-layout result does not necessarily follow the 50/50 rule previously described, because the worst-case path primarily includes component delays.
- For some hard-to-meet timing constraints, the worst-case path is mainly made up of logic delay. Because total routing delay makes up only a small percentage of the total path delay spread out across two or three nets, expecting the timing of these paths to be reduced any further is unrealistic. In general, you can reduce excessive block delays and improve design performance by decreasing the number of logic levels in the design.

## Analyzing the Design using the PlanAhead Software

The PlanAhead software can be used to perform post-layout design analysis. Graphical layout analysis and timing path viewing, as well as floorplanning can be performed to both analyze design results as well as aid in design closure.

1. In the Hierarchy pane of the Project Navigator Design panel, select the `stopwatch` module.
2. In the Processes pane, expand **Implement Design**, expand **Place & Route**, and double-click **Analyze Timing/Floorplan Design (PlanAhead)**.

The process is shown in the following figure.

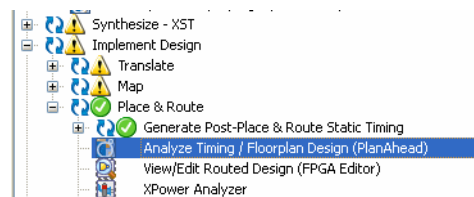

Figure 6-23: Analyze Timing/Floorplan Design (PlanAhead) Process



- When the PlanAhead software opens, select one of the timing paths in the Timing Results tab. You will be able to view the path graphically in the Device view, and also view details of the path and the associated delays in the Properties tab.

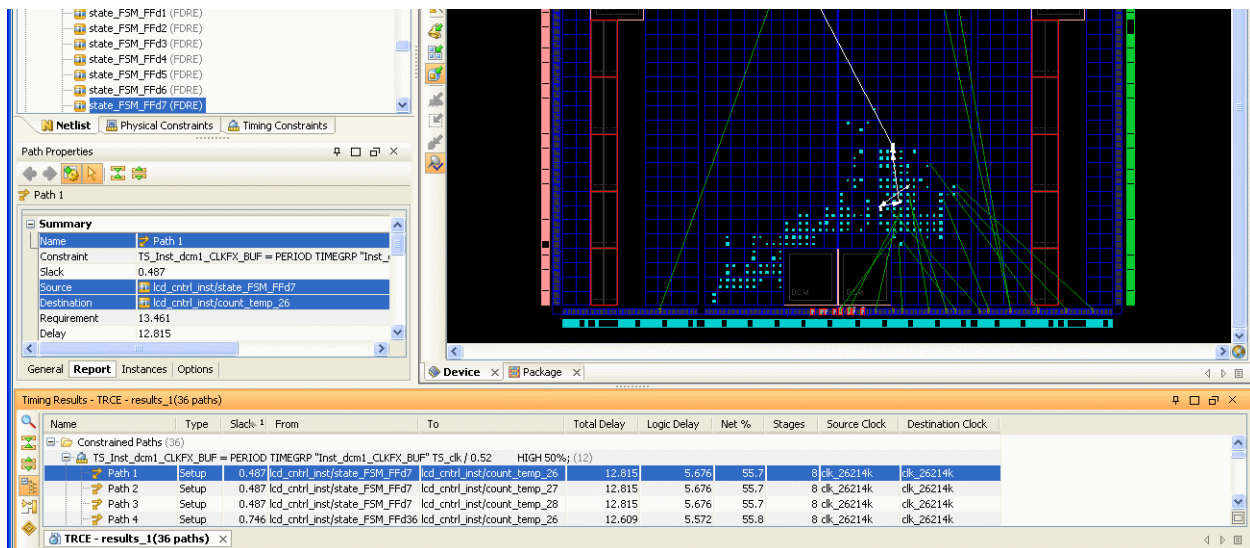

Figure 6-24: Viewing Timing Path in PlanAhead Software

- Zoom in on the path in the Device view by clicking and dragging a box around the area.  
For a detailed tutorial on the full set of capabilities in the PlanAhead software related to timing analysis and design closure, select **Help > PlanAhead Tutorials > Design Analysis and Floorplanning for Performance**.
- To close the PlanAhead software, select **File > Exit**.

## Creating Configuration Data

After analyzing the design, you need to create configuration data. A configuration bitstream is created for downloading to a target device or for formatting into a PROM programming file.

In this tutorial, you will create configuration data for a Xilinx Serial PROM. To create a bitstream for the target device, set the properties and run configuration as follows:

- In the Hierarchy pane of the Project Navigator Design panel, select the stopwatch module.
- In the Processes pane, right-click **Generate Programming File**, and select **Process Properties**.
- In the Process Properties dialog box, click the **Startup Options** category.

4. Change the FPGA Start-Up Clock property from CCLK to **JTAG Clock**.

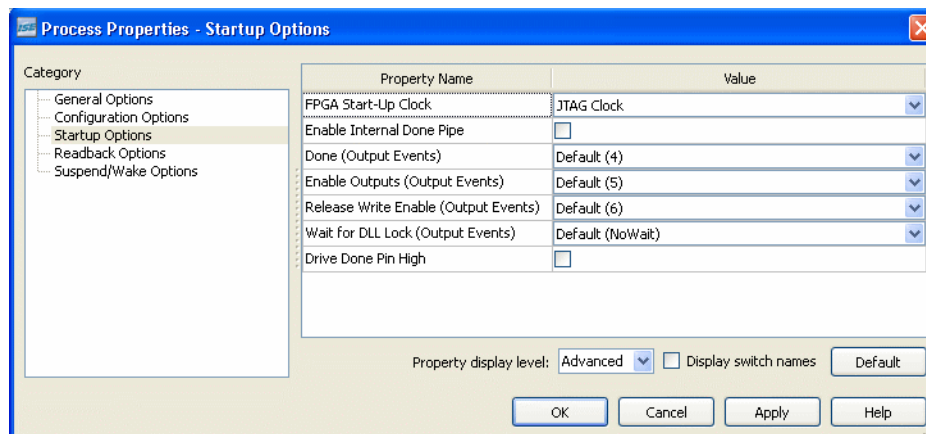

Figure 6-25: Process Properties Startup Options

**Note:** You can use CCLK if you are configuring Select Map or Serial Slave.

5. Click **OK**.
6. In the Processes pane, double-click **Generate Programming File** to create a bitstream of this design.

The BitGen program creates the bitstream file (in this tutorial, the `stopwatch.bit` file), which contains the actual configuration data.

7. To review the Programming File Generation Report, open the **Bitgen Report** in the Design Summary/Report Viewer. Verify that the specified options were used when creating the configuration data.

## Creating a PROM File with iMPACT

To program a single device using iMPACT, all you need is a bitstream file. To program several devices in a daisy chain configuration or to program your devices using a PROM, you must use iMPACT to create a PROM file. iMPACT accepts any number of bitstreams and creates one or more PROM files containing one or more daisy chain configurations.

In iMPACT, a wizard enables you to do the following:

- Create a PROM file.
- Add additional bitstreams to the daisy chain.
- Create additional daisy chains.
- Remove the current bitstream and start over, or immediately save the current PROM file configuration.

For this tutorial, create a PROM file in iMPACT as follows:

1. In the Processes pane, expand **Configure Target Device**, and double-click **Generate Target PROM/ACE File**.
2. In iMPACT, double-click on **Create PROM File (PROM File Formatter)** in the iMPACT Flows window.

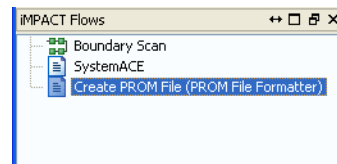

Figure 6-26: Create PROM File

3. In the PROM File Formatter window, select **Xilinx Flash/PROM** in the Select Storage Target section.
4. Click the green arrow to activate the next section.
5. In the Add Storage Device(s) section, click the **Auto Select PROM** checkbox.
6. Click the green arrow to activate the next section.
7. In the Enter Data section, enter an Output File Name of **stopwatch1**.
8. Verify that the Checksum Fill Value is set to **FF** and the File Format is **MCS**.

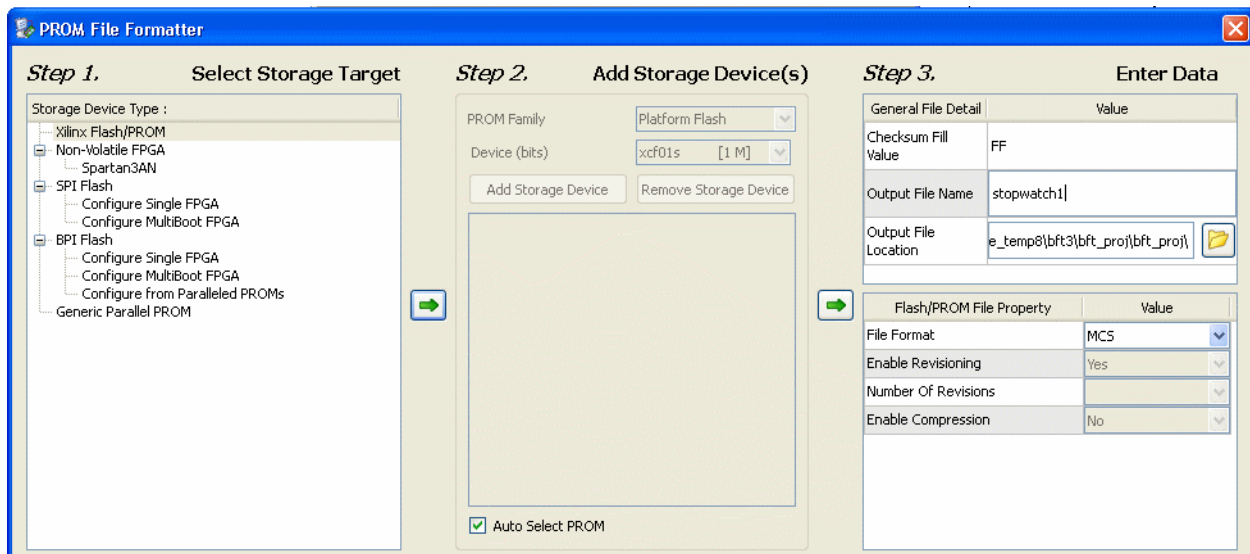

Figure 6-27: PROM File Formatter

9. Click **OK** to close the PROM File Formatter.
10. In the Add Device dialog box, click **OK** and then select the **stopwatch.bit** file.
11. Click **No** when you are asked if you would like to add another design file to the datastream.
12. Click **OK** to complete the process.
13. Select the device graphic in the workspace area, then in the iMPACT Processes view, select **Generate File**.

iMPACT displays the PROM associated with your bitstream file.

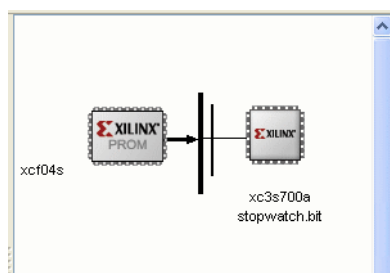

Figure 6-28: PROM File

14. To close iMPACT, select **File > Exit**.
15. If prompted to save the project, select **Yes**, then name the project file **stopwatch\_impact.ipf**.

With the resulting `stopwatch.bit`, `stopwatch1.mcs`, and a MSK file generated along with the BIT file, you are ready for programming your device using iMPACT. For more information on programming a device, see the iMPACT Help, available from the iMPACT application by selecting **Help > Help Topics**.

This completes the “Design Implementation” chapter of the tutorial. For more information on this design flow and implementation methodologies, see the ISE Help, available from the ISE software by selecting **Help > Help Topics**.

## Command Line Implementation

The ISE software allows you to easily view and extract the command line arguments for the various steps of the implementation process. This allows you to verify the options being used or to create a command batch file to replicate the design flow.

At any stage of the design flow, you can look at the command line arguments for completed processes by double-clicking **View Command Line Log File** under the **Design Utilities** process hierarchy in the Processes pane. This process opens a file named `<source_name>.cmd_log` in read-only mode. To create an editable batch file, select **File > Save As** and enter the desired file name.

Sections of the command line log file can also be copied from `<source_name>.cmd_log` using either the copy-and-paste method or the drag-and-drop method into a text file.

For a complete listing of command line options for most Xilinx executables, refer to the *Command Line Tools User Guide (UG628)*. Command line options are organized according to implementation tools. This guide is available from the ISE Software Manuals collection, automatically installed with your ISE software. To open the Software Manuals collection, select **Help > Software Manuals**. The [Software Manuals](#) collection is also available from the Xilinx website. Command line options can also be obtained by typing the executable name followed by the `-h` option at a command prompt.

# Timing Simulation

---

## Overview of Timing Simulation Flow

Timing simulation uses the block and routing delay information from a routed design to give a more accurate assessment of the behavior of the circuit under worst-case conditions. For this reason, timing simulation is performed after the design has been placed and routed.

Timing (post-Place and Route) simulation is a highly recommended part of the HDL design flow for Xilinx® devices. Timing simulation uses the detailed timing and design layout information that is available after Place and Route. This enables simulation of the design, which closely matches the actual device operation. Performing a timing simulation in addition to a static timing analysis will help to uncover issues that cannot be found in a static timing analysis alone. To verify the design, the design should be analyzed both statically and dynamically.

In this chapter, you will perform a timing simulation using either the ModelSim simulator or the Xilinx ISim simulator.

## Getting Started

The following sections outline the requirements to perform this part of the tutorial flow.

### Required Software

To simulate with ModelSim, you must have the Xilinx ISE® Design Suite and ModelSim simulator installed. Refer to [Chapter 5, Behavioral Simulation](#), for information on installing and setting up ModelSim. Simulating with ISim requires that the ISE Design Suite software is installed.

## Required Files

The timing simulation flow requires the following files:

- **Design files (VHDL or Verilog)**

This chapter assumes that you have completed [Chapter 6, Design Implementation](#), and thus, have a placed and routed design. The NetGen tool will be used in this chapter to create a simulation netlist from the placed and routed design, which will be used to represent the design during the timing simulation.

- **Test bench file (VHDL or Verilog)**

To simulate the design, a test bench is needed to provide stimulus to the design. You should use the same test bench that was used to perform the behavioral simulation. Please refer to [Adding an HDL Test Bench in Chapter 5](#) if you do not already have a test bench in your project.

- **Xilinx simulation libraries**

For timing simulation, the SIMPRIM library is needed to simulate the design.

To perform timing simulation of Xilinx designs in any HDL simulator, the SIMPRIM library must be set up correctly. The timing simulation netlist created by Xilinx is composed entirely of instantiated primitives, which are modeled in the SIMPRIM library.

If you completed [Chapter 5, Behavioral Simulation](#), the SIMPRIM library should already be compiled. For more information on compiling and setting up Xilinx simulation libraries, see [Xilinx Simulation Libraries in Chapter 5](#).

## Specifying a Simulator

To specify the simulator to simulate the stopwatch design, do the following:

1. In the Hierarchy pane of the Project Navigator Design panel, right-click the device line (xc3s700A-4fg484), and select **Design Properties**.
2. In the Design Properties dialog box, set the Simulator field to **ISim (VHDL/Verilog)** or **ModelSim** (with the appropriate type and language).

**Note:** ModelSim and Xilinx ISim are the only simulators that are integrated with Project Navigator. Selecting a different simulator (for example, NC-Sim or VCS) will set the correct options for NetGen to create a simulation netlist for that simulator, but Project Navigator will not directly open the simulator. For additional information about simulation and for a list of other supported simulators, see the *Synthesis and Simulation Design Guide (UG626)*. This guide is available from the ISE Software Manuals collection, automatically installed with your ISE software. To open the Software Manuals collection, select **Help > Software Manuals**. The [Software Manuals](#) collection is also available from the Xilinx website.

## Timing Simulation Using ModelSim

The Xilinx ISE software provides an integrated flow with the Mentor ModelSim simulator. The ISE software enables you to create work directories, compile source files, initialize simulation, and control simulation properties for ModelSim.

**Note:** To simulate with ISim, skip to [Timing Simulation Using Xilinx ISim](#). Whether you choose to use the ModelSim simulator or ISim for this tutorial, the end result is the same.

## Specifying Simulation Process Properties

To set the simulation process properties, do the following:

1. In the View pane of the Project Navigator Design panel, select **Simulation**, and select **Post-Route** from the drop-down list.
2. In the Hierarchy pane, select the test bench file (`stopwatch_tb`).
3. In the Processes pane, expand **ModelSim Simulator**, right-click **Simulate Post-Place & Route Model**, and select **Process Properties**.

**Note:** If the ModelSim Simulator processes do not appear, ensure that you selected ModelSim in the Design Properties dialog box, as described in [Specifying a Simulator](#). If this setting is correct and the ModelSim Simulator processes still do not appear, ensure that Project Navigator can find the `modelsim.exe` file. To set the location for this file, select **Edit > Preferences**. In the left pane of the Preferences dialog box, expand **ISE General**, and click **Integrated Tools**. In the right pane, under Model Tech Simulator, browse to the location of `modelsim.exe` file. For example: `c:\modeltech_xe\win32xoe\modelsim.exe`.

4. In the Process Properties dialog box, ensure that the Property display level is set to **Advanced**.

This global setting enables you to see all available properties.

5. Select the **Simulation Model Properties** category. These properties set the options that NetGen uses when generating the simulation netlist. For a description of each property, click the **Help** button.

The properties should appear as shown in the following figure. For this tutorial, the default Simulation Model Properties are used.

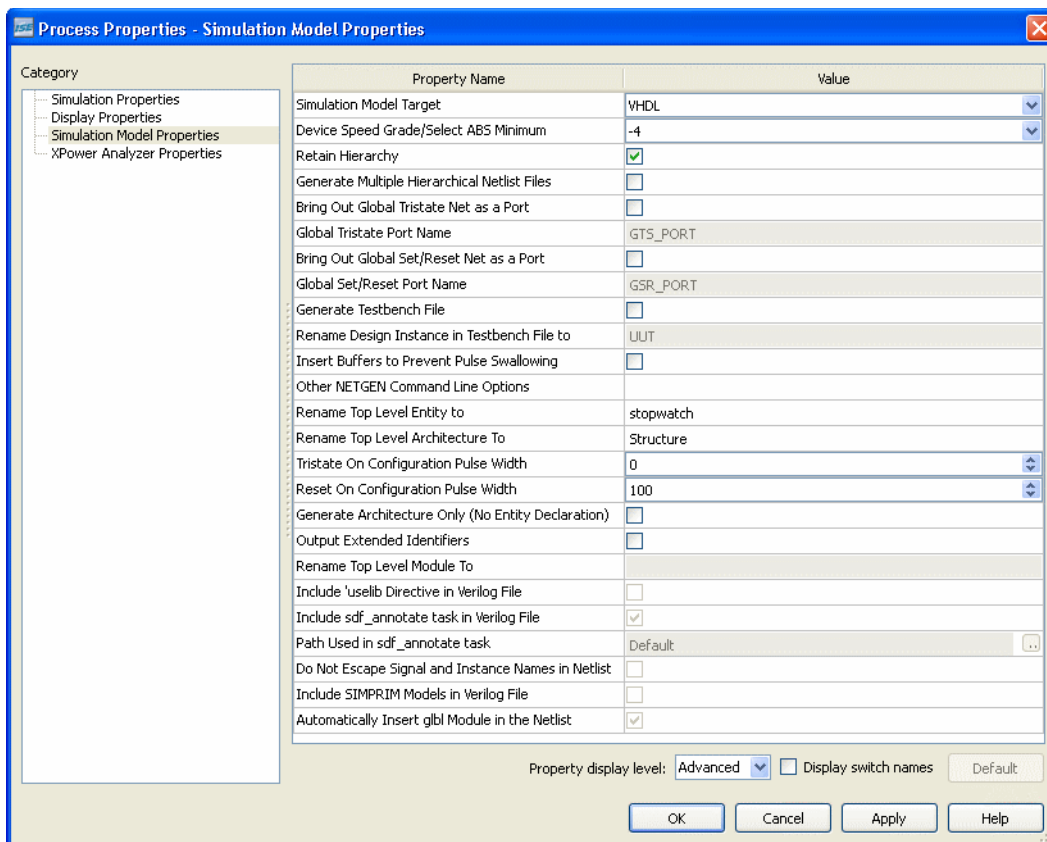

Figure 7-1: Simulation Model Properties

6. Select the **Display Properties** category. These properties give you control over the ModelSim simulation windows. When timing simulation is launched from the ISE software, three windows open by default: the Signal window, the Structure window, and the Wave window. For more details on ModelSim simulator windows, refer to the *ModelSim User Guide*.
7. Select the **Simulation Properties** category. These properties set the options that ModelSim uses to run the timing simulation. For a description of each property, click the **Help** button.



The properties should appear as shown in the following figure. Set the Simulation Run Time property to **2000 ns**.

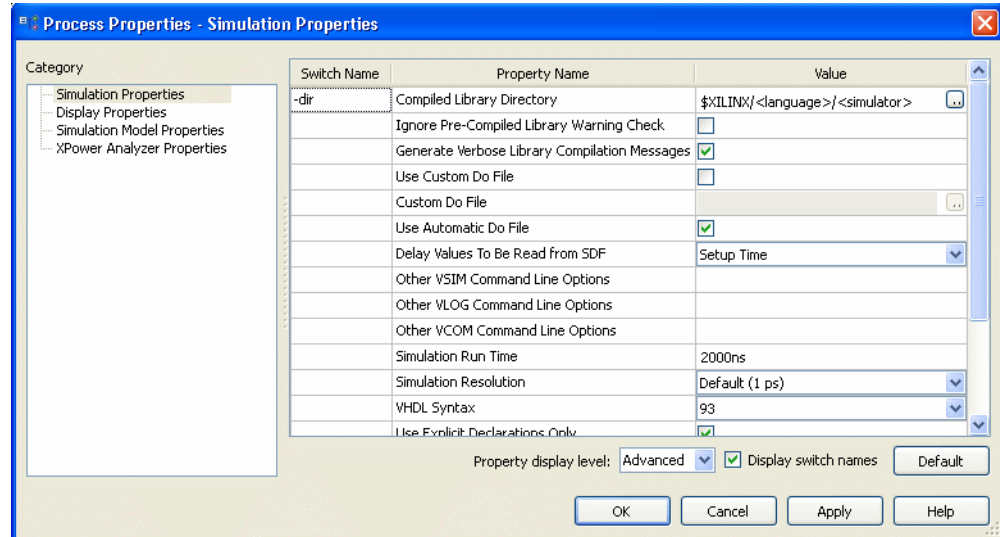

Figure 7-2: Simulation Properties

- Click **OK** to close the Process Properties dialog box.

## Performing Simulation

To start the timing simulation, double-click **Simulate Post-Place and Route Model** in the Processes pane.

The ISE software will run NetGen to create the timing simulation model. The ISE software will then call ModelSim and create the working directory, compile the source files, load the design, and run the simulation for the time specified.

**Note:** The majority of this design runs at 100 Hz and would take a significant amount of time to simulate. This is why the counter will seem like it is not working in a short simulation. For the purpose of this tutorial, only the DCM signals will be monitored to verify that they work correctly.

## Adding Signals

To view signals during the simulation, you must add them to the Wave window. The ISE software automatically adds all the top-level ports to the Wave window. Additional signals are displayed in the Signal window based on the selected structure in the Structure window.

There are two basic methods for adding signals to the Simulator Wave window:

- Drag and drop from the Signal/Object window.
- Highlight signals in the Signal/Object window and then select **Add > Wave > Selected Signals**.

The following procedure explains how to add additional signals in the design hierarchy. In this tutorial, you will be adding the DCM signals to the waveform.

**Note:** If you are using ModelSim version 6.0 or higher, all the windows are docked by default. All windows can be undocked by clicking the **Undock** icon.



Figure 7-3: **Undock Icon**

1. In the Structure/Instance window, expand the **UUT** hierarchy.

The following figure shows the Structure/Instance window for the Schematic flow. The graphics and the layout of the Structure/Instance window for a Verilog or VHDL flow may be different.

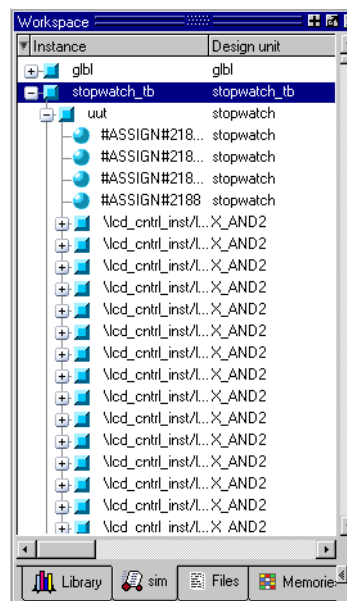

Figure 7-4: **Structure/Instance Window—Schematic Flow**

2. Click the Structure/Instance window, and select **Edit > Find**.
3. Type **x\_dcm** in the search box, and select **Entity/Module** in the Field section.
4. After ModelSim locates X\_DCM, select **X\_DCM\_SP**, and click on the signals/objects window. All the signal names for the DCM will be listed.
5. Select the Signal/Object window, and select **Edit > Find**.
6. Type **CLKIN** in the search box and select the **Exact** checkbox.
7. Click and drag CLKIN from the Signal/Object window to the Wave window.

8. Click and drag the following signals from the Signal/Object window to the Wave window:
  - RST
  - CLKFX
  - CLK0
  - LOCKED

**Note:** Multiple signals can be selected by holding down the **Ctrl** key. In place of using the drag and drop method select **Add to Wave > Selected Signals**.

## Adding Dividers

ModelSim has the capability to add dividers in the Wave window to make it easier to differentiate the signals. To add a divider called DCM Signals, do the following:

1. Right-click anywhere in the signal section of the Wave window. If necessary, undock the window and maximize the window for a larger view of the waveform.
2. Select **Insert Divider**.
3. Enter **DCM Signals** in the Divider Name box.
4. Click **OK**.
5. Click and drag the newly created divider to above the CLKIN signal.

**Note:** Stretch the first column in the waveform to see the signals clearly. The hierarchy in the signal name can also be turned off by selecting **Tools > Options > Wave Preferences**. In the Display Signal Path box, enter **2** and click **OK**.

After adding the DCM Signals divider, the waveform appears as shown in the following figure.

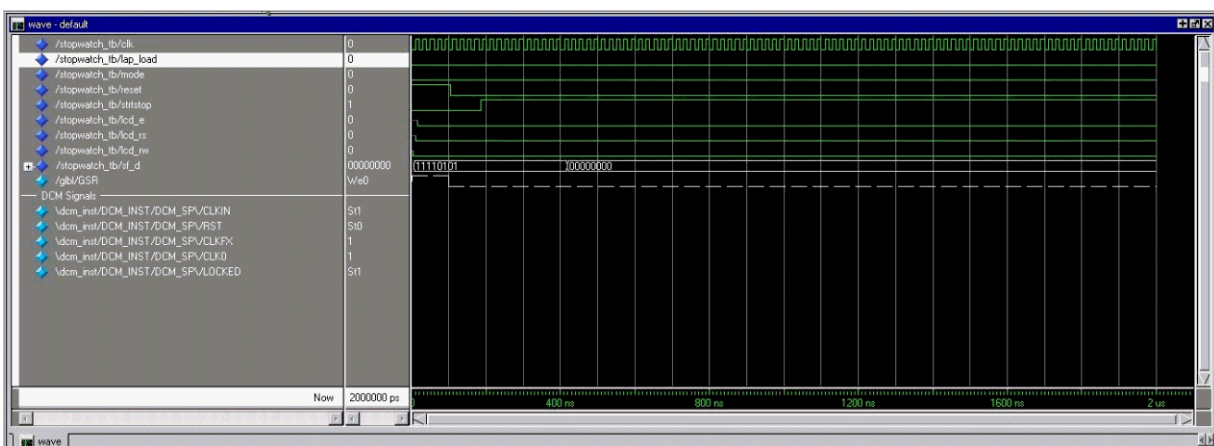

Figure 7-5: Resulting Waveform

The waveforms have not been drawn for the newly added signals. This is because ModelSim did not record the data for these signals. By default, ModelSim only records data for the signals that are added to the Wave window while the simulation is running. Therefore, after new signals are added to the Wave window, you must rerun the simulation for the desired amount of time.

## Rerunning Simulation

To restart and rerun the simulation, do the following:

1. Click the Restart Simulation icon.



Figure 7-6: Restart Simulation Icon

The Restart dialog box opens.

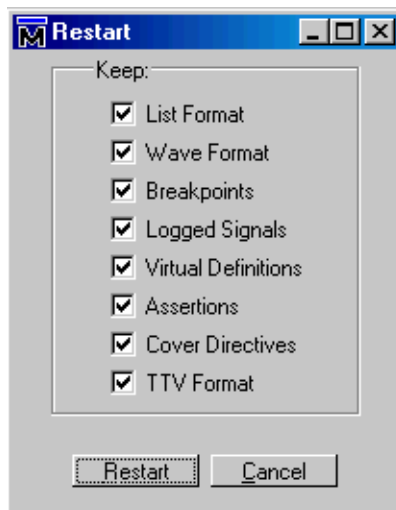

Figure 7-7: Restart Dialog Box

2. Click **Restart**.
3. At the ModelSim command prompt, enter **run 2000 ns** and hit the **Enter** key.

```
VSIM 5> run 2000 ns
```

Figure 7-8: Entering the Run Command

The simulation will run for 2000 ns. The waveforms for the DCM should now be visible in the Wave window.

## Analyzing the Signals

Now the DCM signals can be analyzed to verify that it works as expected. The CLK0 must be 50 Mhz and the CLKFX should be approximately 26 Mhz. The DCM signals should only be analyzed after the LOCKED signal has gone high. Until the LOCKED signal is high the DCM outputs are not valid.

ModelSim has the capability to add cursors to carefully measure the distance between signals. To measure the CLK0, do the following:

1. Select **Add > Cursor twice to place two cursors on the wave view**.
2. Click and drag the first cursor to the rising edge transition on the CLK0 signal after the LOCKED signal has gone high.

3. Click and drag the second cursor to a position just right of the first cursor on the CLK0 signal.
4. Click the Find Next Transition icon twice to move the cursor to the next rising edge on the CLK0 signal.



Figure 7-9: Find Next Transition Icon

Look at the bottom of the waveform to view the distance between the two cursors. The measurement should read 20000 ps. This converts to 50 Mhz, which is the input frequency from the test bench, which in turn should be the DCM CLK0 output.

Measure CLKFX using the same steps as above. The measurement should read 38462 ps. This equals approximately 26 Mhz.

## Saving the Simulation

The ModelSim simulator provides the capability of saving the signals list in the Wave window. Save the signals list after new signals or stimuli are added, and after simulation is rerun. The saved signals list can easily be loaded each time the simulation is started. To save the signals list, do the following:

1. In the Wave window, select **File > Save Format**.
2. In the Save Format dialog box, rename the filename from the default `wave.do` to `dcm_signal_tim.do`.

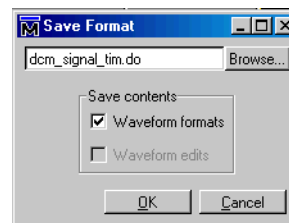

Figure 7-10: Save Format Dialog Box

3. Click **OK**.

After restarting the simulation, you can select **File > Load** in the Wave window to reload this file.

Your timing simulation is complete, and you are ready to program your device by following [Chapter 8, Configuration Using iMPACT](#).

## Timing Simulation Using Xilinx ISim

Follow this section of the tutorial if you have skipped the previous section, [Timing Simulation Using ModelSim](#).

### Specifying Simulation Process Properties

To set the simulation process properties, do the following:

1. In the View pane of the Project Navigator Design panel, select **Simulation**, and select **Post-Route** from the drop-down list.
2. In the Hierarchy pane, select the test bench file (`stopwatch_tb`).
3. In the Processes pane, expand **ISim Simulator**, right-click **Simulate Post-Place & Route Model**, and select **Process Properties**.
4. In the Process Properties dialog box, ensure that the Property display level is set to **Advanced**.

This global setting enables you to see all available properties.

5. Select the **Simulation Model Properties** category. These properties set the options that NetGen uses when generating the simulation netlist. For a description of each property, click the **Help** button.

For this tutorial, the default Simulation Model Properties are used.

6. Select the **ISim Properties** category. These properties set the options the simulator uses to run the timing simulation. For a description of each property, click the **Help** button.

The properties should appear as shown in the following figure. Set the Simulation Run Time property to **2000 ns**.

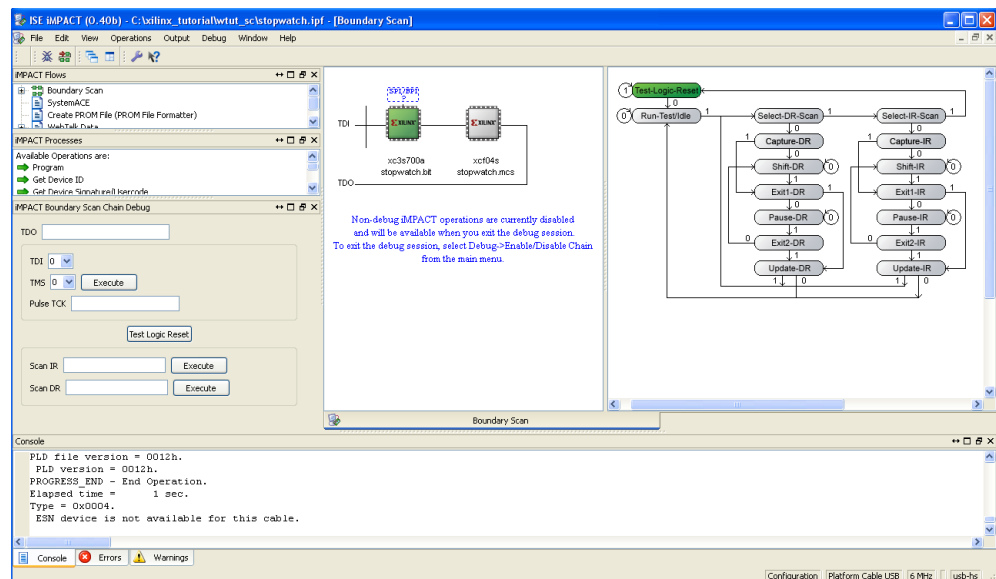

Figure 7-11: Simulation Properties

7. Click **OK** to close the Process Properties dialog box.

## Performing Simulation

To start the timing simulation, double-click **Simulate Post-Place and Route Model** in the Processes pane.

When a simulation process is run, Project Navigator automatically runs NetGen to generate a timing simulation model from the placed and routed design. The ISim then compiles the source files, loads the design, and runs the simulation for the time specified.

**Note:** The majority of this design runs at 100 Hz and would take a significant amount of time to simulate. This is why the counter will seem like it is not working in a short simulation. For the purpose of this tutorial, only the DCM signals will be monitored to verify that they work correctly.

## Adding Signals

To view signals during the simulation, you must add them to the waveform window. The ISE software automatically adds all the top-level ports to the waveform window. All available external (top-level ports) and internal signals are displayed in the simulation hierarchy.

The following procedure explains how to add additional signals in the design hierarchy. In this tutorial, you will be adding the DCM signals to the waveform.

1. In the Instances and Processes panel, expand the **stopwatch\_tb** hierarchy.
2. Expand the **UUT** hierarchy.
3. Locate and select **Inst\_dcm1\_DCM\_SP\_INST**
4. In the Objects window, select the **locked** signal, and click on **Add to Wave Window**.

The following figure shows the Simulation Instances and Simulation Objects window for the VHDL flow. The signal names and layout in the Simulation Instances window for a schematic or VHDL flow may be different.

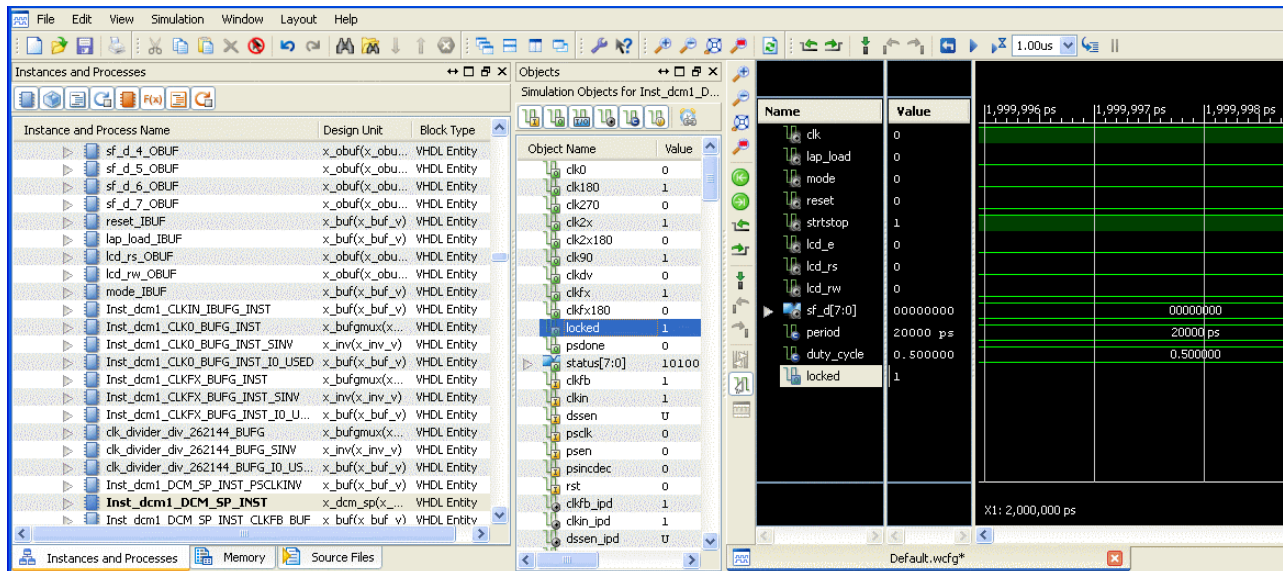

Figure 7-12: Simulation Instances and Simulation Objects Windows—VHDL Flow



5. Click and drag the following X\_DCM\_SP signals from the simulation hierarchy to the waveform window:

- RST
- CLKFX
- CLK0
- CLKIN

**Note:** Multiple signals can be selected by pressing the **Ctrl** key.

## Viewing Full Signal Names

A signal name can be viewed using either the complete hierarchical name or the short name, which omits hierarchy information. To change the signal name display, do the following:

1. Right-click the desired signal in the waveform window.
2. Select **Name > Long** or **Name > Short**.

Stretch the first column in the waveform to see the signals clearly.

The waveform should appear as shown in the following figure.

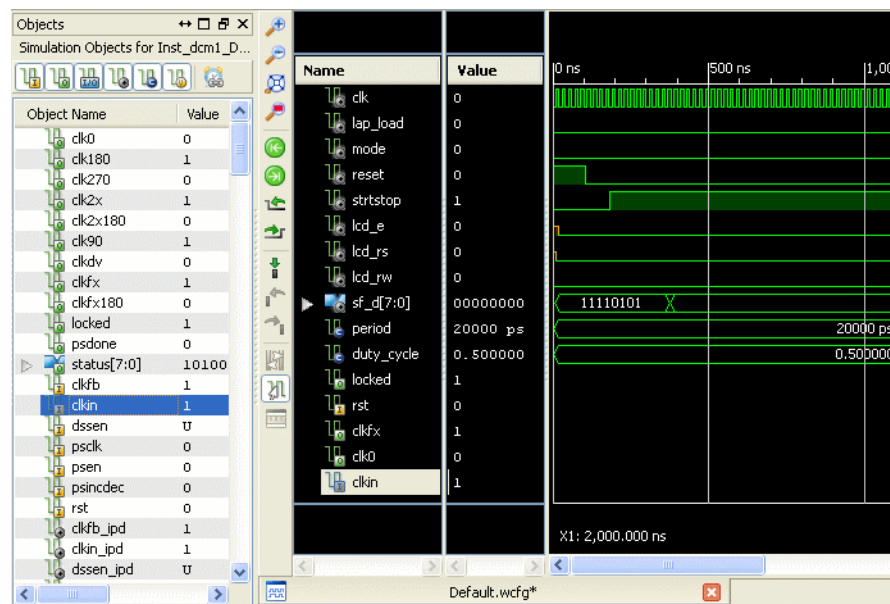

Figure 7-13: Resulting Waveform

Notice that the waveforms have not been drawn for the newly added signals. This is because ISim did not record the data for these signals. ISim only records data for the signals that are added to the waveform window while the simulation is running. Therefore, after new signals are added to the waveform window, you must rerun the simulation for the desired amount of time.



## Rerunning Simulation

To restart and rerun the simulation, do the following:

1. Click the Restart Simulation toolbar button.



Figure 7-14: Restart Simulation Icon

2. At the Sim Console command prompt, enter **run 2000 ns** and hit the **Enter** key.

```
* |run 2000 ns
```

Figure 7-15: Entering the Run Command

The simulation will run for 2000 ns. The waveforms for the DCM should now be visible in the Simulation window.

## Analyzing the Signals

Now the DCM signals can be analyzed to verify that they are working as expected. The CLK0 must be 50 Mhz and the CLKFX should be approximately 26 Mhz. The DCM signals should only be analyzed after the LOCKED signal has gone high. Until the LOCKED signal is high the DCM outputs are not valid.

ISim has the capability to add cursors to carefully measure the distance between signals. To measure the CLK0, do the following:

1. If necessary, zoom in on the waveform using the local Zoom toolbar buttons.
2. In the local waveform viewer toolbar, click the Snap to Transition toolbar button.



Figure 7-16: Snap to Transition Toolbar Button

3. Click on the first rising edge transition on the CLK0 signal after the LOCKED signal has gone high, then drag the cursor to the right to the next rising edge transition of the CLK0 signal.

At the bottom of the waveform window, the start point time, end point time, and delta times are shown. The delta should read 20.0 ns. This converts to 50 Mhz, which is

the input frequency from the test bench, which in turn should be the DCM CLK0 output.

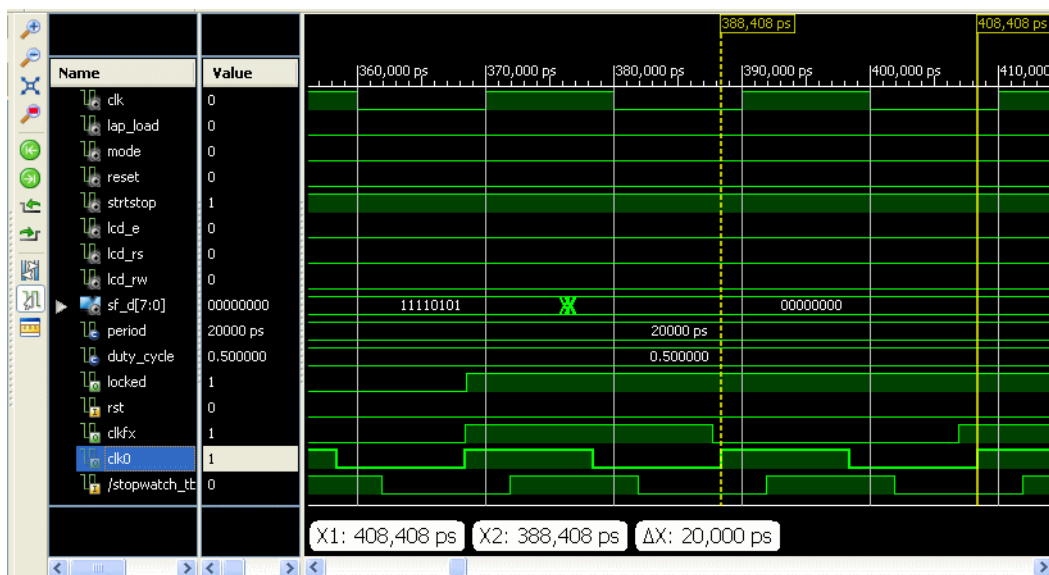

Figure 7-17: Waveform Viewer Displaying Time Between Transitions

4. Measure CLKFX using the same steps as above. The measurement should read 38.5 ns, this equals approximately 26 Mhz.

Your timing simulation is complete and you are ready to program your device by following [Chapter 8, Configuration Using iMPACT](#).

# Configuration Using iMPACT

---

## Overview of iMPACT

This chapter takes you on a tour of iMPACT, a file generation and device programming tool. iMPACT enables you to program through several parallel cables, including the Platform Cable USB. iMPACT can create bitstream files, System ACE™ solution files, PROM files, and SVF/XSVF files. The SVF/XSVF files can be played backed without having to recreate the chain.

## Device Support

For information on supported devices, refer to the [ISE Design Suite: Release Notes Guide \(UG631\)](#) available from the Xilinx® website.

## Download Cable Support

The following cables are supported.

### Parallel Cable IV

The Parallel Cable connects to the parallel port of your computer and can be used to facilitate Boundary-Scan functionality. For more information, see the [Xilinx Parallel Cable IV Data Sheet](#) available from the Xilinx website.

### Platform Cable USB

The Platform Cable connects to the USB port of your computer and can be used to facilitate Boundary-Scan functionality. For more information, see the [Platform Cable USB Data Sheet](#) available from the Xilinx website.

### Platform Cable USB-II

The Platform Cable connects to the USB port of your computer and can be used to facilitate Boundary-Scan functionality. For more information, see the [Platform Cable USB-II Data Sheet](#) available from the Xilinx website.

## Configuration Mode Support

iMPACT currently supports the Boundary-Scan configuration mode for FPGAs, CPLDs, PROMs (XCFxxS and XCFxxP), and third-party SPI/BPI Flash devices.

## Getting Started

The following sections outline the requirements to perform this part of the tutorial flow.

### Generating the Configuration Files

To follow this chapter, you must have the following files for the stopwatch design:

- **BIT file**  
A binary file that contains proprietary header information as well as configuration data.
- **MCS file**  
An ASCII file that contains PROM configuration information.
- **MSK file**  
A binary file that contains the same configuration commands as a BIT file, but that has mask data in place of configuration data. This data is not used to configure the device, but is used for verification. If a mask bit is 0, the bit should be verified against the bit stream data. If a mask bit is 1, the bit should not be verified. This file is generated along with the BIT file.

These files are generated in [Chapter 6, Design Implementation](#).

The tutorial project files are provided with the ISE Design Suite [Tutorials](#) available from the Xilinx website. Download the project files for the VHDL, Verilog, or schematic design flow.

### Connecting the Cable

Prior to launching iMPACT, connect the parallel side of the cable to your computer's parallel port, and connect the cable to the Spartan™-3 Starter Kit demo board. Be sure that the board is powered.

### Starting the Software

This section describes how to start the iMPACT software from the ISE® software and how to run the iMPACT software standalone.

## Opening iMPACT from Project Navigator

To start iMPACT from Project Navigator, double-click **Manage Configuration Project (iMPACT)** in the Processes pane in the Design panel, as shown in the following figure.

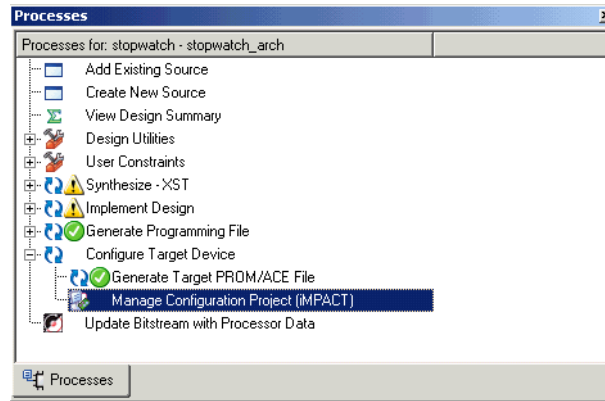

Figure 8-1: Opening iMPACT from Project Navigator

## Opening iMPACT Standalone

To open iMPACT without going through an ISE project, use one of the following methods:

- *PC only:* Click **Start > All Programs > Xilinx ISE Design Suite > ISE Design Tools > Tools > iMPACT**.
- *PC or Linux:* Type **impact** at a command prompt.

**Note:** To run applications from the command line, you must configure the system environment to point to the ISE Design Suite. To do this, run the appropriate `settings32.csh/bat` or `settings64.csh/bat` file from the `<XILINX installation directory>\`. For more information, refer to the [ISE Design Suite: Installation and Licensing Guide \(UG798\)](#) available from the Xilinx website.

## Using Boundary-Scan Configuration Mode

For this tutorial, you will be using the Boundary-Scan configuration mode. Boundary-Scan configuration mode enables you to perform Boundary-Scan operations on any chain comprising JTAG compliant devices. The chain can consist of both Xilinx and non-Xilinx devices; however, limited operations will be available for non-Xilinx devices. To perform operations, the cable must be connected and the JTAG pins, TDI, TCK, TMS, and TDO, must be connected from the cable to the board.

## Specifying Boundary-Scan Configuration Mode

In iMPACT, creating a new project includes specifying the configuration mode and the device to program. To select Boundary-Scan Mode, do the following:

1. Select **File > New Project**.
2. In the Automatically create and save a project dialog box, select **Yes**.
3. In the Welcome to iMPACT dialog box, select **Configure Devices using Boundary-Scan (JTAG)**.
4. Ensure that **Automatically connect to a cable and identify Boundary-Scan chain** is selected.

**Note:** The selection box also gives you the option to Enter a Boundary-Scan Chain, which enables you to manually add devices to create the chain. This option enables you to generate an SVF/XSVF programming file and is discussed in a later section in this chapter. Automatically detecting and initializing the chain should be performed whenever possible.

5. Click **OK**.

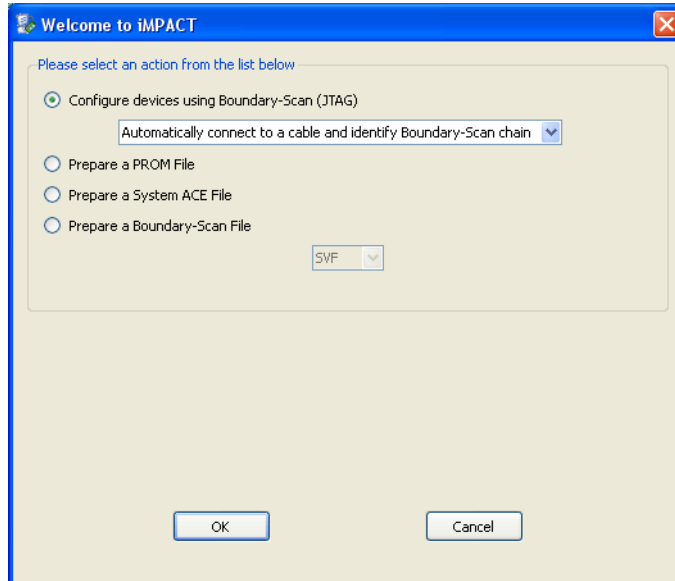

Figure 8-2: Selecting Automatic Boundary-Scan Using iMPACT Wizard

iMPACT will pass data through the devices and automatically identify the size and composition of the Boundary-Scan chain. Any supported Xilinx device will be recognized and labeled in iMPACT. Any other device will be labeled as unknown. The software will then highlight each device in the chain and prompt you to assign a configuration file or BSDL file.

**Note:** If you were not prompted to select a configuration mode or automatic Boundary-Scan mode, right-click in the iMPACT window and select **Initialize Chain**. The software will identify the chain if the connections to the board are working. Go to [Troubleshooting Boundary-Scan Configuration](#) if you are having problems.

## Assigning Configuration Files

After initializing a chain, the software prompts you for a configuration file (see [Figure 8-3](#)). The configuration file is used to program the device. There are several types of configuration files:

- Bitstream file (\*.bit, \*.rbit, \*.isc) is used to configure an FPGA.
- JEDEC file (\*.jed, \*.isc) is used to configure a CPLD.
- PROM file (\*.mcs, \*.hex) is used to configure a PROM.

When the software prompts you to select a configuration file for the first device (XC3S700A), do the following:

1. Select the BIT file from your project working directory.
2. Click **Open**.

You should receive a warning stating that the startup clock has been changed to JtagClk.

3. Click **OK**.

The following figure shows configuration file selection.

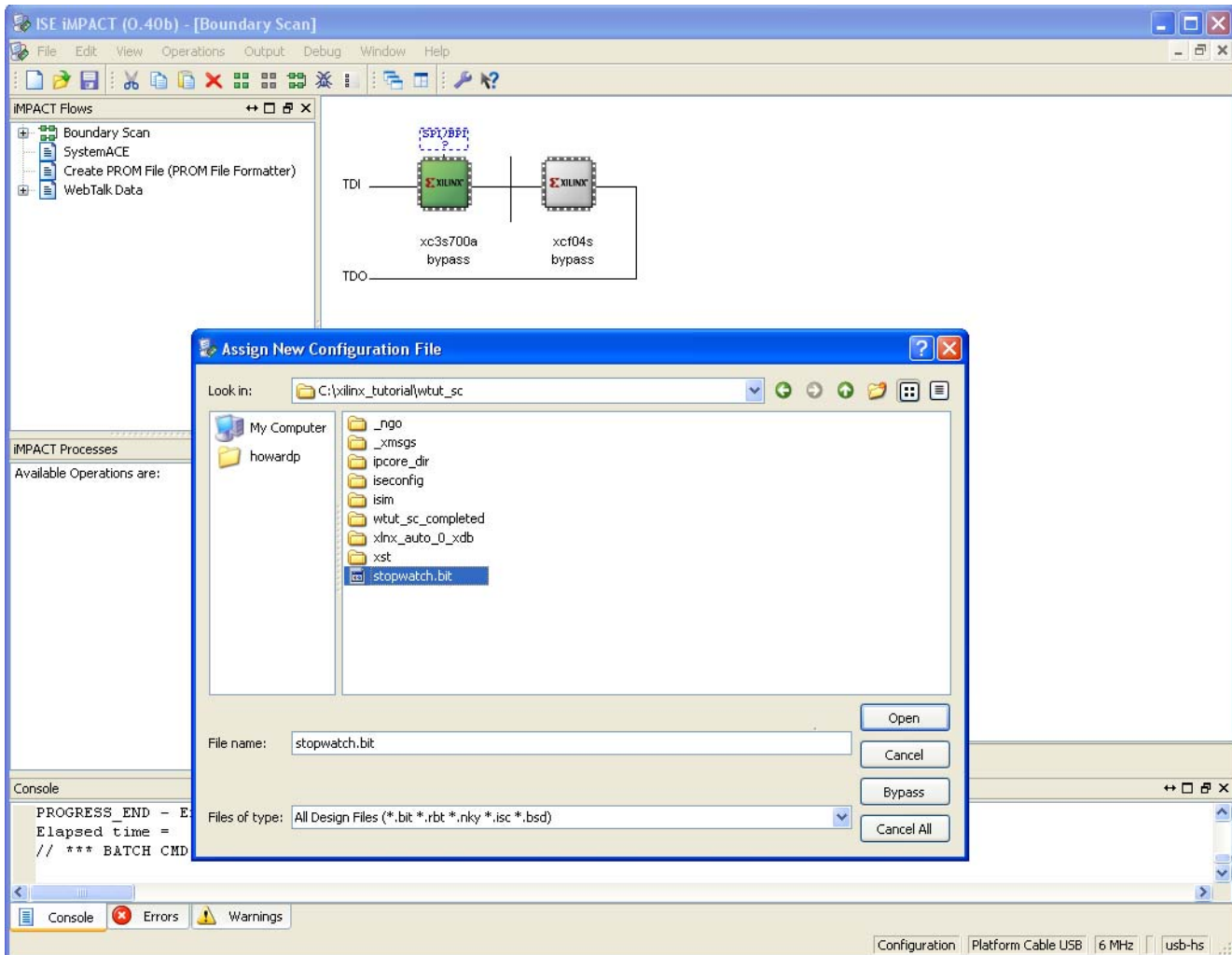

Figure 8-3: Selecting a Configuration File

**Note:** If a configuration file is not available, a Boundary-Scan Description File (BSDL or BSD) file can be applied instead. The BSDL file provides the software with the necessary Boundary-Scan information that allows a subset of the Boundary-Scan operations to be available for that device. To have the ISE software automatically select a BSDL file (for both Xilinx and non-Xilinx devices), select **Bypass** in the Assign New Configuration File dialog box.

4. When the software prompts you to select a configuration file for the second device (XCF02S), select the MCS file from your project working directory.
5. Click **Open**.

## Saving the Project File

After the chain has been fully described and configuration files are assigned, you should save your iMPACT Project File (IPF) for later use. To do this, select **File > Save Project As**. The Save As dialog box opens, and you can browse and save your project file accordingly. To restore the chain after reopening iMPACT, select **File > Open Project** and browse to the IPF.

**Note:** Previous versions of the ISE software use Configuration Data Files (CDF). These files can still be opened and used in iMPACT. iMPACT Project Files can also be exported to a CDF.

## Editing Preferences

To edit the preferences for the Boundary-Scan configuration, select **Edit > Preferences**. This selection opens the window shown in the following figure. Click **Help** for a description of the preferences. In this tutorial, keep the default values and click **OK**.

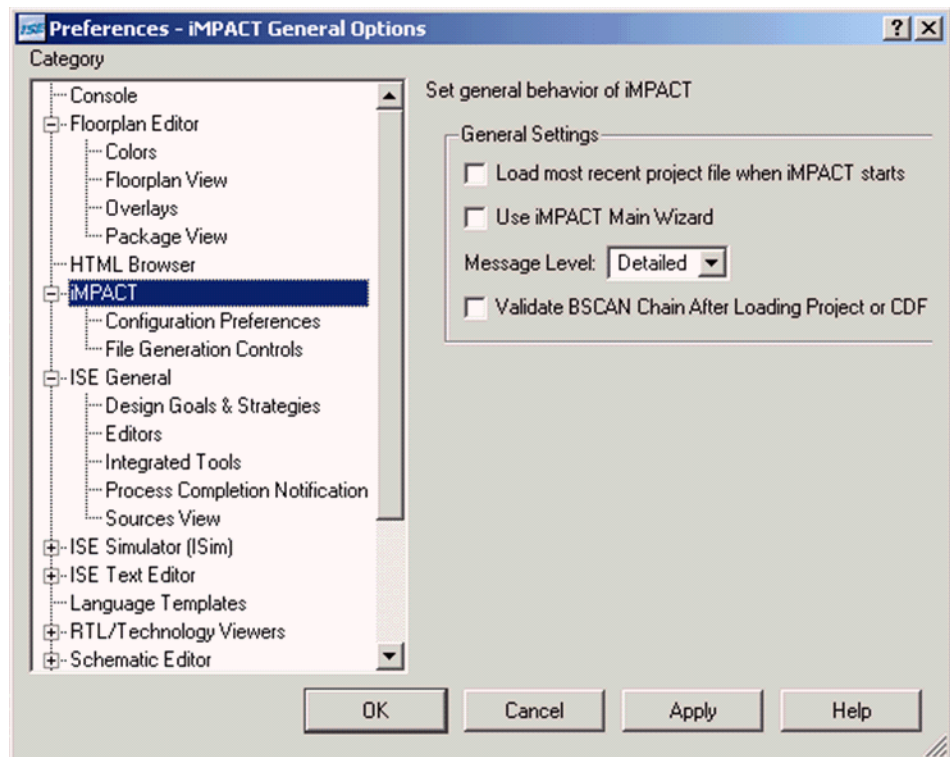

Figure 8-4: Edit Preferences



## Performing Boundary-Scan Operations

You can perform Boundary-Scan operations on one device at a time. The available Boundary-Scan operations vary based on the device and the configuration file that was applied to the device. To see a list of the available options, right-click on any device in the chain. This brings up a window with all of the available options.

When you select a device and perform an operation on that device, all other devices in the chain are automatically placed in BYPASS or HIGHZ, depending on your iMPACT Preferences setting. For more information about Preferences, see [Editing Preferences](#).

To perform an operation, right-click on a device and select one of the options. In this section, you will retrieve the device ID and run the programming option to verify the first device as follows:

1. Right-click on the XC3S700A device, and select **Get Device ID**.

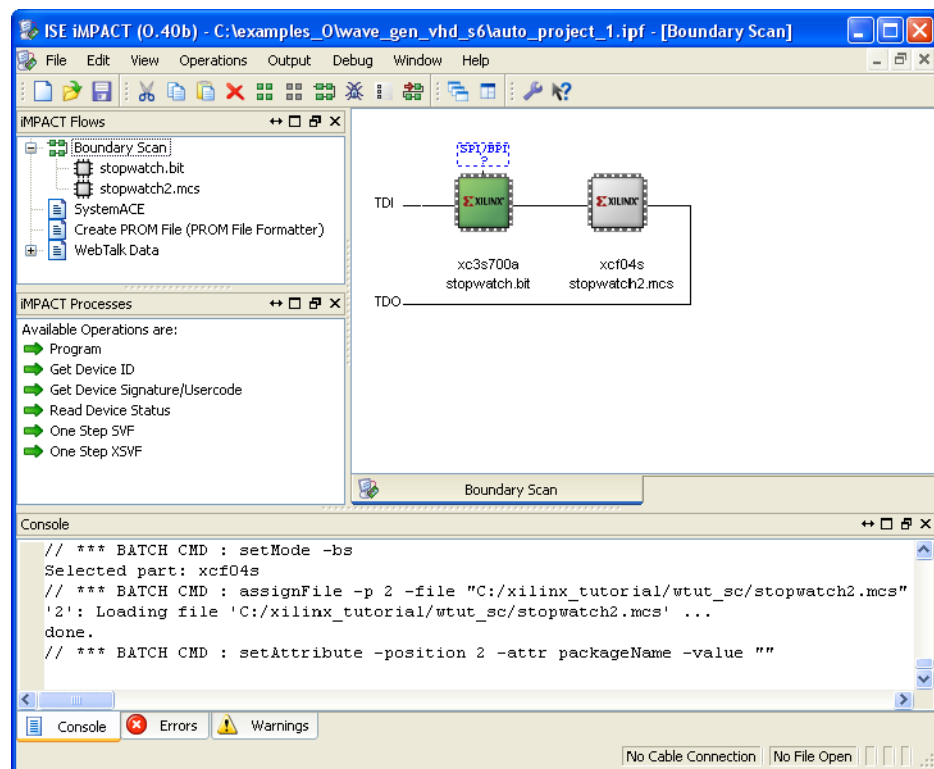

Figure 8-5: Available Boundary-Scan Operations for XC3S700A Device

The software accesses the IDCODE for this Spartan-3A device. The result is displayed in the log window, as shown in the following figure.

```
// *** BATCH CMD : ReadIdcode -p 1
Maximum TCK operating frequency for this device chain: 0.
Validating chain...
Boundary-scan chain validated successfully.
'1': IDCODE is '00000010011000101000000010010011'
'1': IDCODE is '02628093' (in hex).
'1': : Manufacturer's ID =Xilinx xc3s700a , Version : 0
```

Figure 8-6: Log Window Showing Result of Get Device ID

2. Right-click on the XC3S700A device, and select **Set Programming Properties**.  
The Device Programming Properties dialog box opens.
3. Select the **Verify** option.  
The Verify option enables the device to be read back and compared to the BIT file using the MSK file that was created earlier.
4. Click **OK** to begin programming.

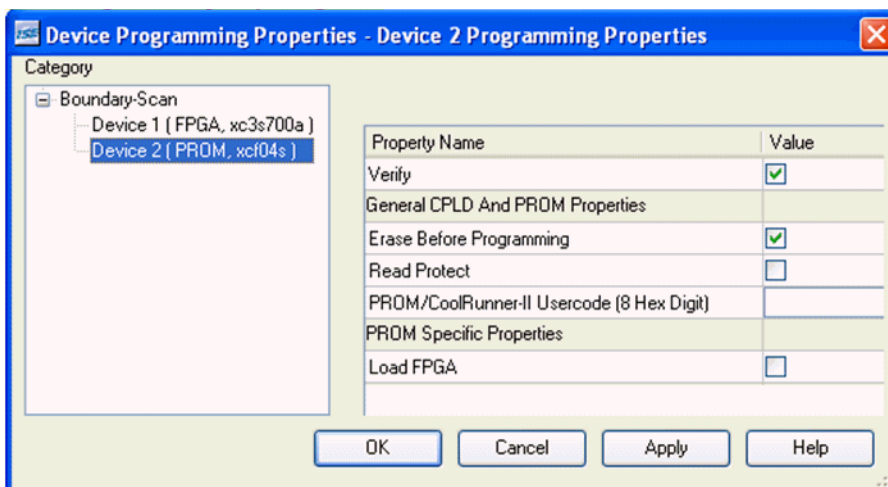

Figure 8-7: Program Options for XC3S700A Device

**Note:** The options available in the Device Programming Properties dialog box vary based on the device you have selected.

- Right-click on the XC3S700A device again, and select **Program**.

The Programming operation begins and an operation status window appears. At the same time, the log window reports all of the operations being performed.

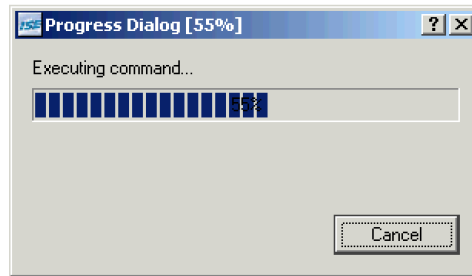

Figure 8-8: Operation Status

When the Program operation completes, a large blue message appears showing that programming was successful, as shown in the following figure. This message disappears after a few seconds.

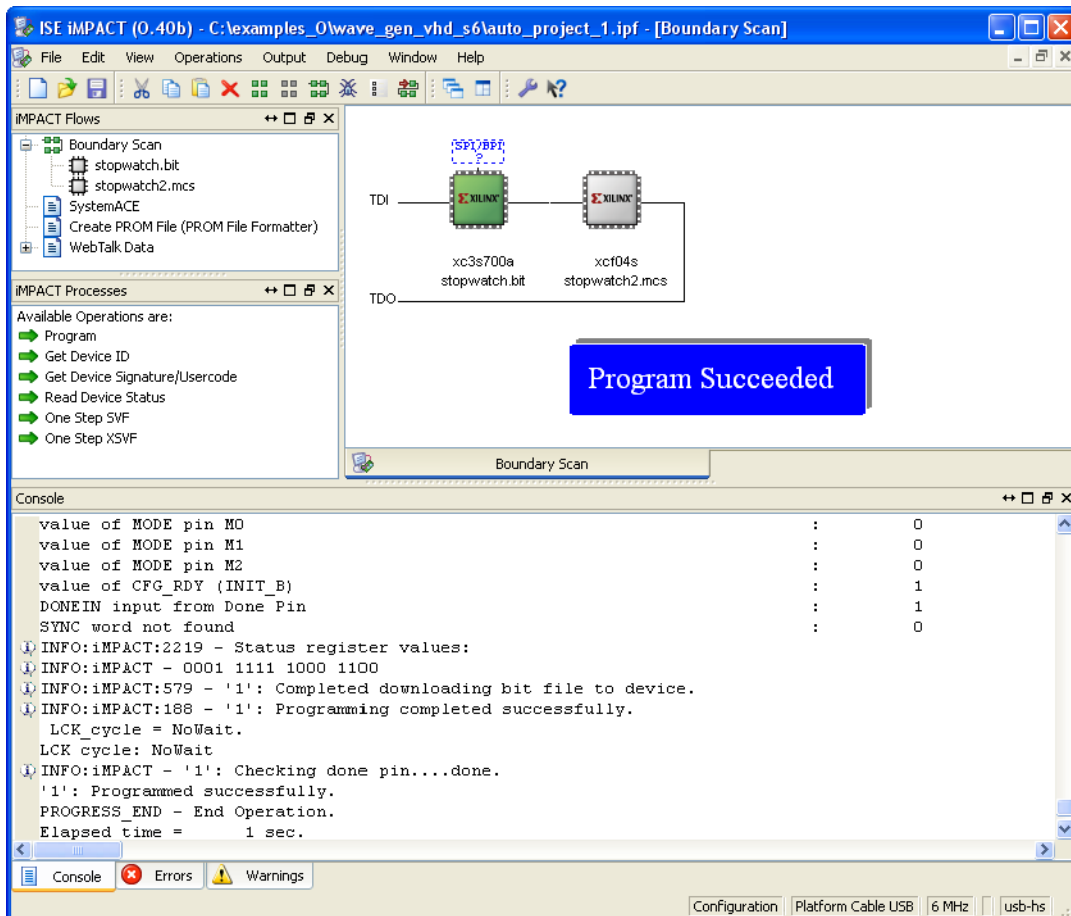

Figure 8-9: Programming Operation Complete

Your design has been programmed and has been verified. The board should now be working and should allow you to start, stop and reset the runner's stopwatch.

## Troubleshooting Boundary-Scan Configuration

The following sections assist you with troubleshooting errors that may occur during Boundary-Scan operations.

### Verifying the Cable Connection

When an error occurs during a Boundary-Scan operation, first verify that the cable connection is established and that the software auto detect function is working. If a connection is still not established after plugging the cable into the board and into your machine, right-click in a blank portion of the iMPACT window and select either **Cable Auto Connect** or **Cable Setup**. Cable Auto Connect will force the software to search every port for a connection. Cable Setup enables you to select the cable and the port to which the cable is connected.

When a connection is found, the bottom of the iMPACT window will display the type of cable connected, the port attached to the cable, and the cable speed, as shown in the following figure.



Figure 8-10: Cable Connection Successful

**Note:** If a cable is connected to the system and the cable autodetection fails, refer to Xilinx [Answer Record 15742](#).

### Verifying the Chain Setup

When an error occurs during a Boundary-Scan operation, verify that the chain is set up correctly and verify that the software can communicate with the devices. The easiest way to do this is to initialize the chain. To do so, right-click in the iMPACT window and select **Initialize Chain**. The software will identify the chain if the connections to the board are working.

If the chain cannot be initialized, it is likely that the hardware is not set up correctly or the cable is not properly connected. If the chain can be initialized, try performing simple operations. For example, try getting the Device ID of every device in the chain. If this can be done, then the hardware is set up correctly and the cable is properly connected.

The debug chain can also be used to manually enter JTAG commands, as shown in the following figure. This can be used for testing commands and verifying that the chain is set up correctly. To use this feature, select **Debug > Enable/Disable Debug Chain** in iMPACT.

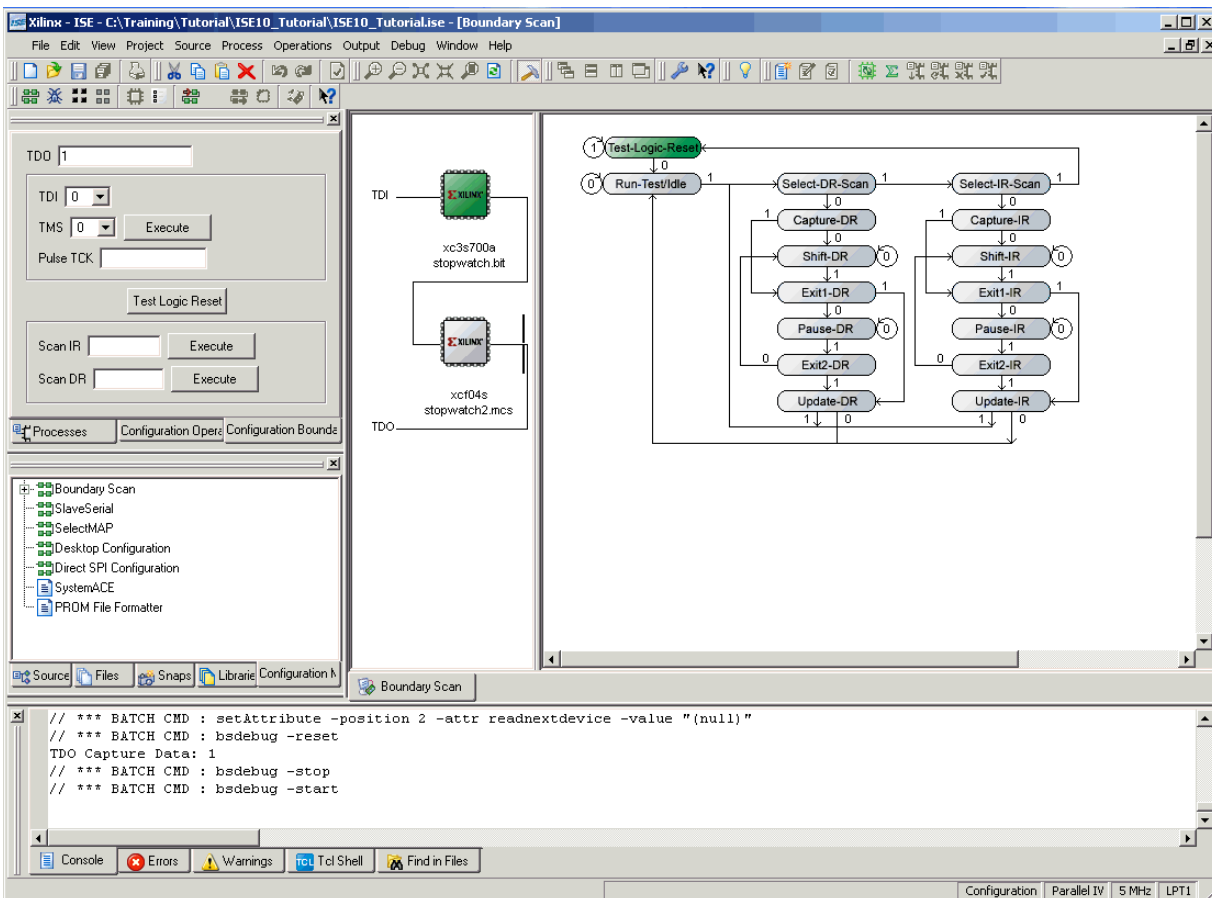

Figure 8-11: Debug Chain

For help using iMPACT Boundary-Scan Debug, use the iMPACT Help, accessible from **Help > Help Topics**. For help with troubleshooting, file a [WebCase](#) on the Xilinx website.

## Creating an SVF File

This section is optional and assumes that you have followed the [Using Boundary-Scan Configuration Mode](#) section and have successfully programmed to a board. In this section, all of the configuration information is written to the SVF file.

iMPACT supports the creation of device programming files in three formats: SVF, XSVF, and STAPL. If you are using third-party programming solutions, you may need to set up your Boundary-Scan chain manually and then create a device programming file. These programming files contain both programming instructions and configuration data, and they are used by Automatic Test Equipment (ATE) machines and embedded controllers to perform Boundary-Scan operations. A cable normally does not need to be connected because no operations are being performed on devices.

## Setting Up the Boundary-Scan Chain

This section assumes that you are continuing from the previous sections of this chapter and already have the chain detected. If not, skip to [Manually Setting Up the JTAG Chain for SVF Generation](#) to define the chain manually.

### Setting Up the JTAG Chain for SVF Generation

To set up the JTAG chain, do the following:

1. Select **Output > SVF File > Create SVF File** to indicate that you are creating a programming file.
2. In the Create New SVF File dialog box, enter **getid** in the File Name field, and click **Save**.
3. An informational message appears stating that all device operations will be directed to the .svf file. Click **OK**.

### Manually Setting Up the JTAG Chain for SVF Generation

For this tutorial, you may skip this section if you completed the [Using Boundary-Scan Configuration Mode](#) section.

The Boundary-Scan chain can be manually created or modified as well. To do this, do the following:

1. Ensure that you are in Boundary-Scan Mode by clicking the **Boundary-Scan tab**.  
You can now add one device at a time.
2. Right-click on an empty space in the iMPACT Boundary-Scan window, and select **Add Xilinx Device** or **Add Non-Xilinx device**.

An Add Device dialog box opens, allowing you to select a configuration file.

3. Select `stopwatch.bit`, and then click **Open**.

The device is added where the large cursor is positioned. To add a device between existing devices, click on the line between them and then add the new device.

Repeat steps 2 and 3 to add the `stopwatch.mcs` file to the chain.

**Note:** The Boundary-Scan chain that you manually create in the software must match the chain on the board, even if you intend to program only some of the devices. All devices must be represented in the iMPACT window.

## Writing to the SVF File

The process of writing to an SVF file is identical to performing Boundary-Scan operations with a cable. You simply right-click on a device and select an operation. Any number of operations can be written to an SVF file.

In this section, you will be writing the device ID to the programming file for the first device, and performing further instructions for the second device.

To write the device ID, do the following:

1. Right-click the first device (XC3S700A), and select **Get Device ID**.

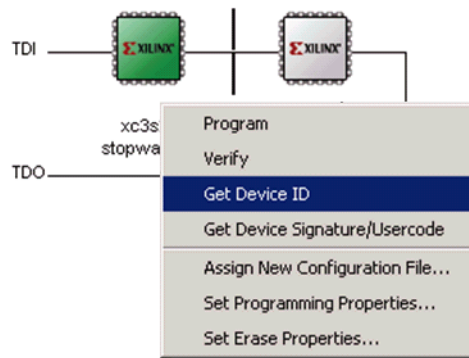

*Figure 8-12: Selecting a Boundary-Scan Operation*

The instructions that are necessary to perform a Get Device ID operation are then written to the file.

- To see the results, select **View > View SVF-STAPL File**. The following figure shows the SVF file after the Get Device ID operation is performed.

```

// Created using Xilinx iMPACT Software [ISE - 10.1]
// Date: Mon May 19 21:44:00 2008

TRST OFF;
ENDIR IDLE;
ENDDR IDLE;
STATE RESET;
STATE IDLE;
FREQUENCY 1E6 HZ;
TIR 0 ;
HIR 0 ;
TDR 0 ;
HDR 0 ;
TIR 0 ;
HIR 0 ;
TDR 0 ;
HDR 0 ;
TIR 0 ;
HIR 0 ;
TDR 0 ;
HDR 0 ;
TIR 0 ;
HIR 0 ;
TDR 0 ;
HDR 0 ;
TIR 0 ;
HIR 14 TDI (3fff) SMASK (3fff) ;
HDR 2 TDI (00) SMASK (03) ;
TDR 0 ;
//Loading device with 'idcode' instruction.
SIR 6 TDI (09) SMASK (3f) ;
SDR 32 TDI (00000000) SMASK (fffffff) TDO (f2628093) MASK (0fbffff) ;
TIR 0 ;
HIR 0 ;
TDR 0 ;
HDR 0 ;
TIR 0 ;
HIR 0 ;
TDR 0 ;
HDR 0 ;
TIR 0 ;
HIR 14 TDI (3fff) SMASK (3fff) ;
HDR 2 TDI (00) SMASK (03) ;
TDR 0 ;
//Loading device with 'idcode' instruction.
SIR 6 TDI (09) ;
SDR 32 TDI (00000000) TDO (f2628093) ;
//Loading device with 'idcode' instruction.
SIR 6 TDI (09) ;
SDR 32 TDI (00000000) TDO (f2628093) ;
TIR 0 ;
HIR 14 TDI (3fff) ;
HDR 2 TDI (00) ;
TDR 0 ;
TIR 0 ;
HIR 0 ;
TDR 0 ;
HDR 0 ;
SIR 20 TDI (0ffff) SMASK (0ffff) ;
SDR 3 TDI (00) SMASK (07) ;

```

Figure 8-13: SVF File That Gets a Device ID from the First Device in the Chain



To write further instructions to the SVF for the second device, do the following:

1. Right-click the second device (XCF02S), and select **Program**.

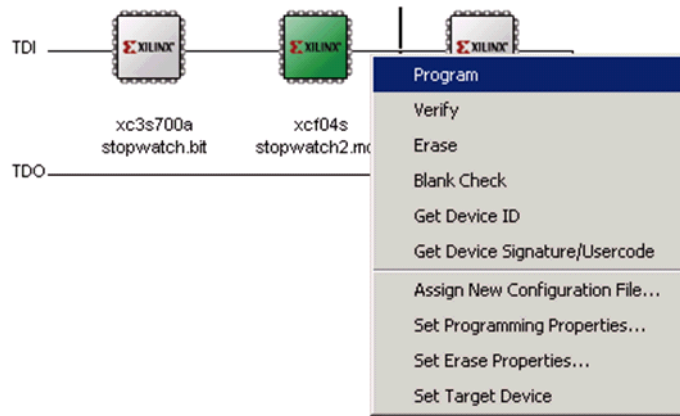

Figure 8-14: Available Boundary-Scan Operations for XCF02S Device

2. Click **OK** in the Programming Properties window.

The instructions and configuration data needed to program the second device are added to the SVF file.

## Stopping Writing to the SVF File

After all the desired operations have been performed, you must add an instruction to close the file from further instructions. To stop writing to the programming file, select **Output > SVF File > Stop Writing to SVF File**.

To add other operations in the future, you can select **Output > SVF File > Append to SVF File**, select the SVF file, and click **Save**.

## Playing Back the SVF or XSVF File

To play back the SVF file that you created to verify the instructions, do the following:

1. Manually create a new chain.
2. Assign the SVF file to the chain by right-clicking and selecting **Add Xilinx Device** and selecting the SVF file in the search window.
3. Right-click on the SVF file in the Boundary-Scan chain and select **Execute XSVF/SVF**.

Your device programming is complete, and you have successfully completed the *ISE In-Depth Tutorial (UG695)*.



# Additional Resources

---

## Xilinx Resources

- *ISE Design Suite: Installation and Licensing Guide (UG798)*:  
[http://www.xilinx.com/support/documentation/sw\\_manuals/xilinx13\\_1/iil.pdf](http://www.xilinx.com/support/documentation/sw_manuals/xilinx13_1/iil.pdf)
- *ISE Design Suite 13: Release Notes Guide (UG631)*:  
[http://www.xilinx.com/support/documentation/sw\\_manuals/xilinx13\\_1/irn.pdf](http://www.xilinx.com/support/documentation/sw_manuals/xilinx13_1/irn.pdf)
- **Xilinx® Documentation**:  
<http://www.xilinx.com/support/documentation>
- **Xilinx Global Glossary**:  
[http://www.xilinx.com/support/documentation/sw\\_manuals/glossary.pdf](http://www.xilinx.com/support/documentation/sw_manuals/glossary.pdf)
- **Xilinx Support**: <http://www.xilinx.com/support>

## ISE Documentation

- **ISE Documents**:  
[http://www.xilinx.com/support/documentation/dt\\_ise13-1.htm](http://www.xilinx.com/support/documentation/dt_ise13-1.htm)
  - *Command Line Tools User Guide (UG628)*:  
[http://www.xilinx.com/support/documentation/sw\\_manuals/xilinx13\\_1/devref.pdf](http://www.xilinx.com/support/documentation/sw_manuals/xilinx13_1/devref.pdf)
  - *Xilinx Synthesis and Simulation Design Guide (UG626)*:  
[http://www.xilinx.com/support/documentation/sw\\_manuals/xilinx13\\_1/sim.pdf](http://www.xilinx.com/support/documentation/sw_manuals/xilinx13_1/sim.pdf)
  - *XST User Guide for Virtex-4, Virtex-5, Spartan-3, and Newer CPLD Devices (UG627)*:  
[http://www.xilinx.com/support/documentation/sw\\_manuals/xilinx13\\_1/xst.pdf](http://www.xilinx.com/support/documentation/sw_manuals/xilinx13_1/xst.pdf)
  - *XST User Guide for Virtex-6, Spartan-6, and 7 Series Devices (UG687)*:  
[http://www.xilinx.com/support/documentation/sw\\_manuals/xilinx13\\_1/xst\\_v6s6.pdf](http://www.xilinx.com/support/documentation/sw_manuals/xilinx13_1/xst_v6s6.pdf)

