

Summary

The Xilinx® Kria KV260 Vision AI Starter Kit is comprised of a non-production version of the K26 system-on-module (SOM), carrier card, and thermal solution. The SOM is very compact and only includes key components such as a Zynq® UltraScale+™ MPSoC based silicon device, memory, boot, and security module. The carrier card allows various interfacing options and includes a power solution and network connectors for camera, display, and microSD card. The thermal solution has a heat sink, heat sink cover, and fan. The Kria KV260 Vision AI Starter Kit is designed to provide customers a platform to evaluate their target applications and ultimately design their own carrier card with Xilinx K26 SOMs. While the SOM itself has broad AI/ML applicability across markets and applications, target applications for the Kria KV260 Vision AI Starter Kit include smart city and machine vision, security cameras, retail analytics, and other industrial applications.

Figure 1: Kria KV260 Vision AI Starter Kit

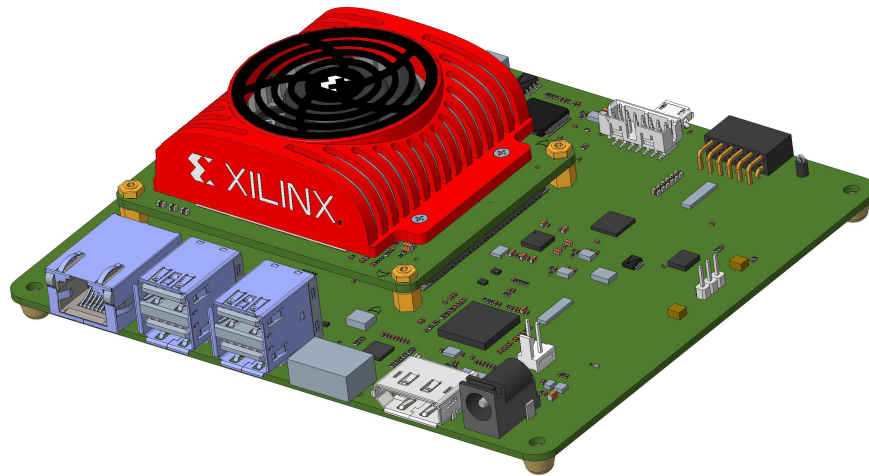

Product Details

The Kria KV260 Vision AI Starter Kit is an evaluation platform for the K26 SOM focused on machine learning (ML) acceleration in vision applications. The kit brings together a Zynq UltraScale+ MPSoC based SOM with user selectable, vision focused peripherals and a set of pre-built accelerated applications. The KV260 and its base K26 SOM are supported for full user customization through Vitis™ platforms, customizable acceleration overlays, and Vivado® tools hardware board files. The integrated combination of hardware, platform, and software provides a quick out-of-box experience for developers that can then be leveraged for product designs.

Figure 2: KV260 Starter Kit Block Diagram

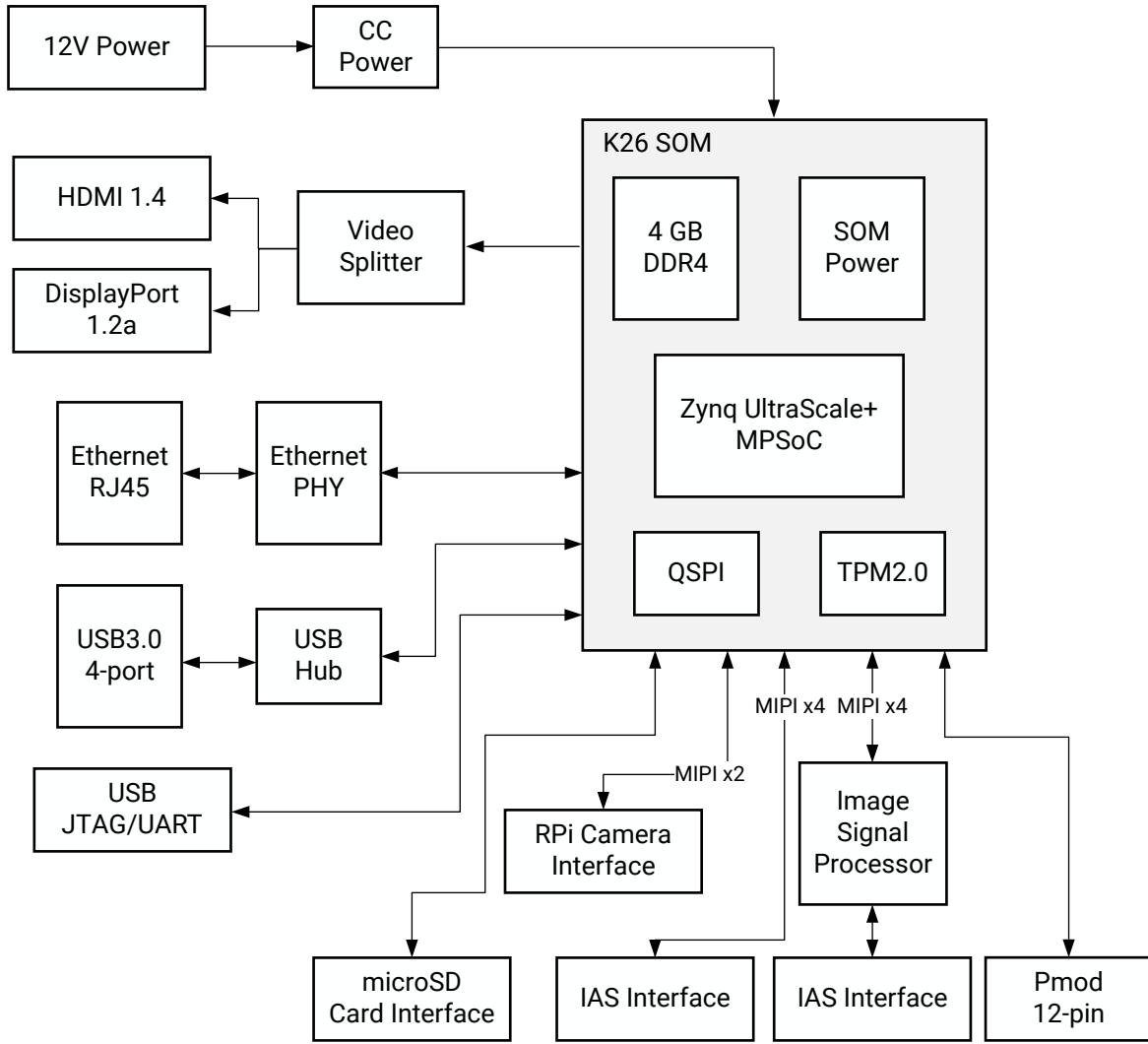

X24577-041421

Table 1: Kria KV260 Vision AI Starter Kit Product Details

Specification	Description
Thermal cooling solution	Active
Weight	205g
Form factor	SOM + Carrier Card
Dimensions of the KV260 Starter Kit	119 mm x 140 mm x 36 mm
Dimensions of the SOM with thermal solution	60 mm x 77 mm x 27 mm
Dimensions of the carrier card	119 mm x 140 mm x 23 mm
System logic cells	256K
Block RAM blocks	144
UltraRAM blocks	64
DSP slices	1.2K
Ethernet interface	One 10/100/1000 Mb/s
DDR memory	4 GB (4 x 512 Mb x 16 bit)
Primary boot memory	512 Mb QSPI
Secondary boot memory	microSD card
Device Security	Zynq UltraScale+ MPSoC hardware root of trust (RoT) in support of secure boot. Infineon TPM2.0 in support of measured boot.
Image sensor processor	OnSemi AP1302 13MP ISP
IAS MIPI sensor interfaces	x2
Raspberry Pi camera interface	x1
PMOD 12-pin interface	x1
USB3.0 interface	x4
DisplayPort 1.2a	x1
HDMI 1.4	x1

Ordering Information

Table 2: Ordering Information

Product SKU	Device	Temperature Grade	Encryption	Description
SK-KV260-G-ED	XCK26-C	Commercial	Disabled	KV260 Starter Kit with encryption disabled
SK-KV260-G	XCK26-C	Commercial	Enabled	KV260 Starter Kit with encryption enabled

Power and Electrical

This section describes the power requirements, power-on sequence, power-on reset sequence, and power management functions.

Table 3: KV260 Starter Kit Power Specifications

Parameter	Description
DC input power	+12V, 3A
Recommended power adapter	The CUI Inc. SMI36-12-V-P6 adapter connected using a center-pin positive barrel connector (2.5 mm ID, 5.5 mm OD)
SOM supply	+5V, 3A (V_{CC_SOM})
SOM power telemetry	Current sense device is available through the I2C bus to monitor the current on the V_{CC_SOM} power rail
USB 3.0	5V, 900 mA per port (limited to 2.1A total)
Pmod interface from Digilent Inc.	3.3V, 100 mA
Raspberry Pi camera interface	3.3V
ON Semiconductor IAS module connector 0	2.75V, 1.8V, 1.2V
ON Semiconductor IAS module connector 1	2.75V, 1.8V, 1.2V

KV260 Starter Kit Power On Sequence

1. External power adapter supplies 12V power
2. On-board regulator generates 5V supply and provides power to other voltage regulators
3. SOM power rail (V_{CC_SOM}) is powered by a 5V supply
4. When the 5V regulator output voltage level is within the specified range and a power-good signal is asserted and the `POWER_OFF_C2M_L` signal is deasserted by the carrier card
5. SOM on board power on sequencing starts
6. Carrier card provides PS and PL V_{CCO} voltage rails after the SOM asserts the $V_{CCOEN_PS_M2C}$ and $V_{CCOEN_PL_M2C}$ signals

KV260 Starter Kit Power On Reset

1. The SOM reset signal (`PS_POR_L`) is held in reset until the `PS_PGOOD` signal is asserted.
2. To perform a hard reset on the SOM, use the reset push-button on the carrier card to assert the `PS_POR_L` signal.
3. All the PS and PL I/O device reset signals on the carrier card are held in reset until 25 ms after the PS and PL power domain are powered up and stable.

Mechanical

This section outlines the mechanical specifications of the Kria KV260 Vision AI Starter Kit.

Table 4: Kria KV260 Vision AI Starter Kit Mechanical Details

Specification	Dimensions
Dimensions of the KV260 Starter Kit	119 mm x 140 mm x 36 mm
Dimensions of the SOM with thermal solution	60 mm x 77 mm x 27 mm
Dimensions of the carrier card	119 mm x 140 mm x 23 mm

Figure 3: Kria K26 SOM and Thermal Solution Mechanical Dimensions

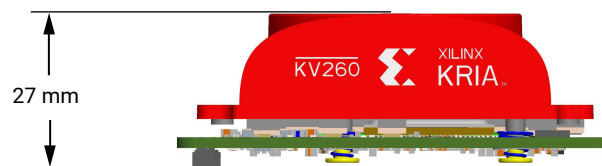
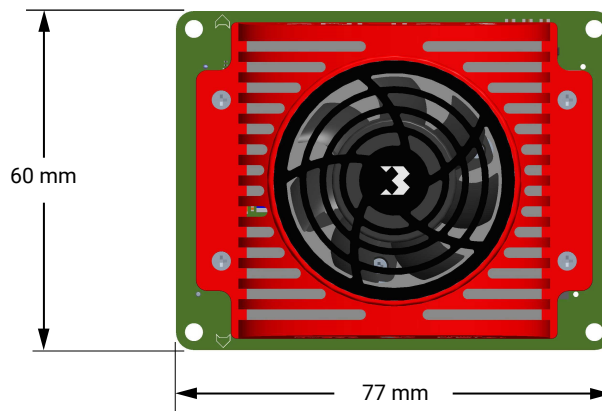

X24583-041321

Figure 4: Kria KV260 Vision AI Starter Kit Mechanical Dimensions

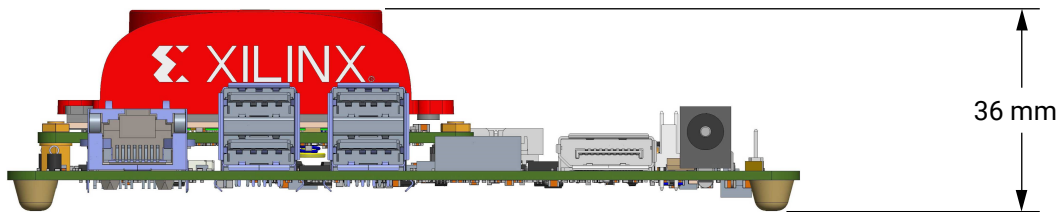
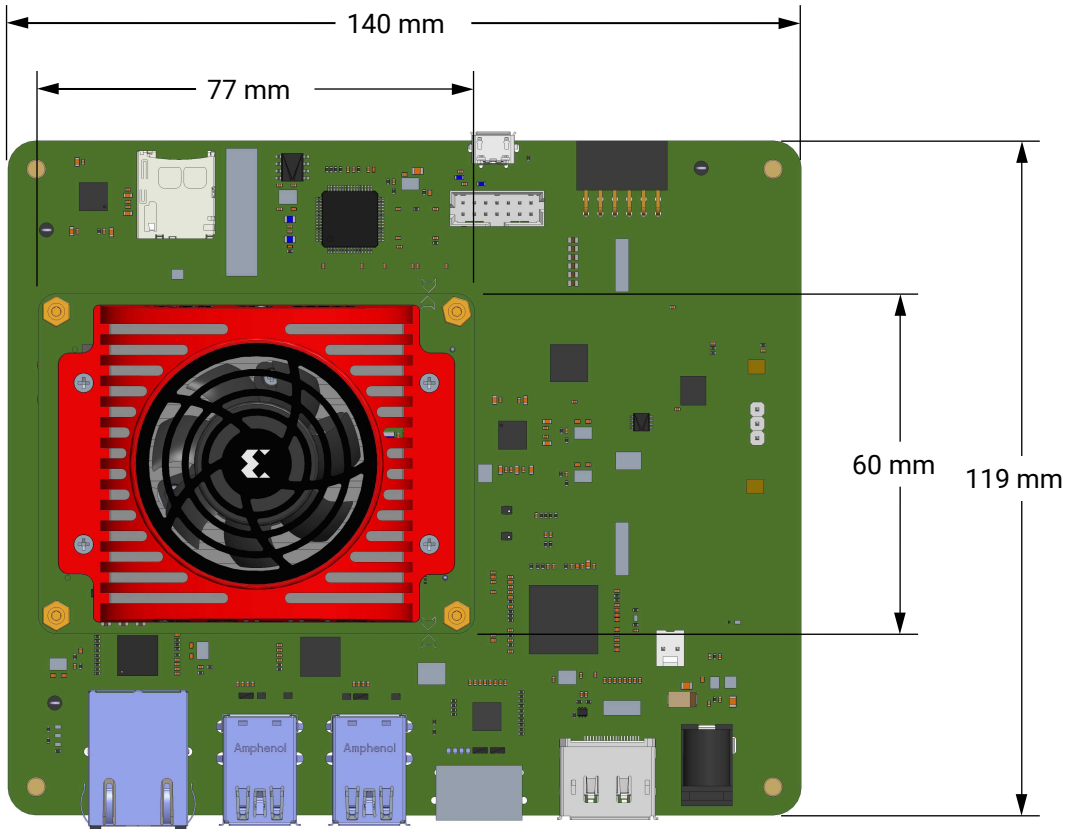

X24584-041321

Figure 5: Kria KV260 Vision AI Starter Kit Carrier Card Mechanical Dimensions

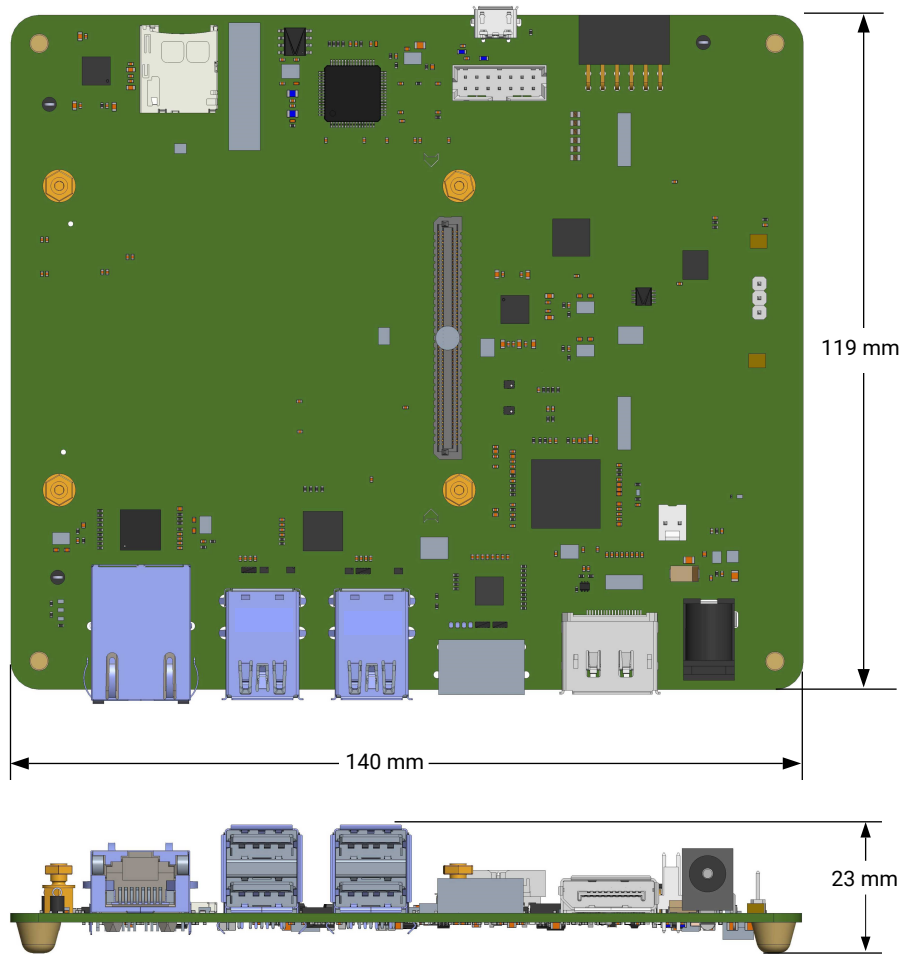

X24585-041321

Thermal

Operating and Storage Temperature Conditions

Table 5: Operating and Storage Temperatures and Humidity Condition

Specification	Condition
Operating temperature	0°C to 35°C (maximum at continuous operation)
Storage temperature	-40°C to 75°C
Operating humidity, non-condensing	8% to 90%, and a dew point of -12°C
Storage humidity, non-condensing	5% to 95%

KV260 Starter Kit Cooling Solution

The KV260 Starter Kit uses an active cooling solution to support the maximum thermal power dissipation of 15W.

Supported Tools

The Kria KV260 Vision AI Starter Kits are enabled in the Xilinx Vivado and Vitis™ tools. For details on getting started with the kit see *Kria KV260 Vision AI Starter Kit User Guide* ([UG1089](#)).

Reliability

The Kria SOM Starter Kits are not designed or qualified for production use. While the kits undergo a basic level of testing and reliability, and should pass all the certification requirements necessary for evaluation kit purposes (for example RoHS and CE), to develop a production quality product, you must purchase the SOM (C or I-grade) and design your own (compatible) carrier cards.

Regulatory Compliance Statements

Safety

The following safety standards apply to all products listed in this document.

IEC 62368-1, 2nd Edition, 2014/A11:2017, *Information technology equipment – Safety, Part 1: General requirements*

EN 62368-1, 2nd Edition, 2014/A11:2017, *Information technology equipment – Safety, Part 1: General requirements*

FCC Class A Products

The following is a list of the products covered by this data sheet:

- SK-KV260-G

- SK-KV260-G-ED

Regulatory Compliance Statements are valid for the production version of the K26 SOM; not for ES boards and the non-production SOM on the KV260 Starter Kit .

Safety Compliance

The following safety standards apply to all products listed above.

- UL 62368-1, 2nd Edition, 2014/A11:2017 (Information Technology Equipment - Safety - Part 1: General Requirements)
- CSA C22.2 No. 60950-1-07, 2nd Edition, 2014/A11:2017 (Information Technology Equipment - Safety - Part 1: General Requirements)
- EU LVD Directive 2014/35/EU
- EN/IEC-62368-12014/A11:2017

EMC Compliance

Class A Products

The following standards apply:

- FCC Part 15 – Radiated & Conducted Emissions (USA)
- CAN ICES-3(A)/NMB-3(A) – Radiated & Conducted Emissions (Canada)
- CISPR 32 – Radiated & Conducted Emissions (International)
- EN55032: 2015 – Radiated & Conducted Emissions (European Union)
- EN55035:2017 – Immunity (European Union)
- EMC Directive 2014/30/EU
- VCCI (Class A)– Radiated & Conducted Emissions (Japan)
- CNS13438 – Radiated & Conducted Emissions (Taiwan)
- CNS 15663 - RoHS (Taiwan)
- AS/NZS CISPR 32 – Radiated and Conducted Emissions (Australia/New Zealand)
- Article 58-2 of Radio Waves Act, Clause 3 (Korea)

Regulatory Compliance Markings

When required, these products are provided with the following product certification markings:

- UL Listed Accessories Mark for the USA and Canada
- CE mark
- FCC markings
- VCCI marking

- Australian RCM mark
- Korea MSIP mark
- Taiwan BSMI mark
- German GS mark

FCC Class A User Information

The Class A products listed above comply with Part 15 of the FCC Rules. Operation is subject to the following two conditions:

1. This device may not cause harmful interference.
2. This device must accept any interference received, including interference that may cause undesired operation.

 **CAUTION!** *This equipment has been tested and found to comply with the limits for a Class A digital device, pursuant to Part 15 of the FCC rules. These limits are designed to provide reasonable protection against harmful interference when the equipment is operated in a commercial environment. This equipment generates, uses, and can radiate radio frequency energy and, if not installed and used in accordance with the instructions, may cause harmful interference to radio communications. Operation of this equipment in a residential area is likely to cause harmful interference, in which case the user will be required to correct the interference at their own expense.*

 **ATTENTION!** *Cet équipement a été testé et jugé conforme à la Class A digital device, conformément à la règle 15 du standard FCC. Ces limites sont conçues pour fournir des protections contre des interférences nuisibles lorsque l'équipement est utilisé dans un environnement commercial. Cet équipement génère, utilise et peut émettre des énergies de radio-fréquence et, s'il n'est pas installé et utilisé conformément aux instructions, peut nuire aux communications radio. L'exploitation de cet équipement dans une zone résidentielle est susceptible de causer des interférences nuisibles, auquel cas l'utilisateur peut être tenu de prendre des mesures adéquates à ses propres frais.*

 **VORSICHT!** *Dieses Gerät wurde getestet und entspricht den Grenzwerten für digitale Geräte der Klasse A gemäß Teil 15 der FCC-Bestimmungen. Diese Grenzwerte bieten einen angemessenen Schutz gegen schädliche Interferenzen, wenn das Gerät in einer gewerblichen Umgebung betrieben wird. Dieses Gerät erzeugt und verwendet Hochfrequenzenergie und kann diese abstrahlen. Wenn es nicht gemäß den Anweisungen installiert und verwendet wird, kann dies Funkstörungen verursachen. Der Betrieb dieses Geräts in einem Wohngebiet kann schädliche Interferenzen verursachen. In diesem Fall muss der Benutzer die Interferenz auf eigene Kosten beheben.*

 **CAUTION!** *If the device is changed or modified without permission from Xilinx, the user may void their authority to operate the equipment.*

 **ATTENTION!** *Si l'appareil est modifié sans l'autorisation de Xilinx, l'utilisateur peut annuler son habilité à utiliser l'équipement.*

 **VORSICHT!** *Wenn das Gerät ohne Erlaubnis von Xilinx geändert wird, kann der Benutzer seine Berechtigung zum Betrieb des Geräts verlieren.*

Canadian Compliance (Industry Canada)

CAN ICES-3(A)/NMB-3(A)

RoHS Compliance

- RoHS Directive 2011/65/EU
- RoHS 3 Directive 2015/863
- SJ/T 11363-2006, 11364-2006, and GB/T 26572-2011 (China RoHS)

VCCI Class A Statement

この装置は、クラス A 情報技術装置です。この装置を家庭環境で使用すると電波妨害を引き起こすことがあります。この場合には使用者が適切な対策を構ずるよう要求されることがあります。

VCCI-A

KCC Notice Class A (Republic of Korea Only)

<p>A급 기기 (업무용 방송통신기기)</p> <p>CLASS A device (commercial broadcasting and communication equipment)</p>	<p>이 기기는 업무용(A급)으로 전자파적합등록을 한 기기이오니 판매자 또는 사용자는 이 점을 주의하시기 바라며, 가정외의 지역에서 사용하는 것을 목적으로 합니다.</p> <p>This device has been approved by EMC registration. Distributors or users pay attention to this point. This device is usually aimed to be used in other area except at home</p>
--	---

BSMI Class A Notice (Taiwan)

警告使用者:

此為甲類資訊技術設備，於居住環境中使用時，可能會造成射頻擾動，在此種情況下，使用者會被要求採取某些適對的對策。

EU WEEE Logo

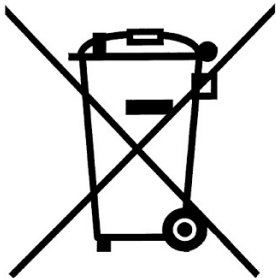

Manufacturer Declaration European Community



Manufacturer Declaration

Xilinx declares that the equipment described in this document is in conformance with the requirements of the European Council Directives listed below:

- Low Voltage Directive 2014/35/EU
- EMC Directive 2014/30/EU
- RoHS 3 Directive 2011/65/EU, 2015/863
- China RoHS Declaration: Standards SJ/T 11363-2006, 11364-2006, and GB/T 26572-2011
- Reach Regulation 1907/2006
- POP Regulation 2019/1021

These products follow the provisions of the European Directive 2014/53/EU.

Dette produkt er i overensstemmelse med det europæiske direktiv 2014/53/EU.

Dit product is in navolging van de bepalingen van Europees Directief 2014/53/EU.

Tämä tuote noudattaa EU-direktiivin 2014/53/EU määräyksiä.

Ce produit est conforme aux exigences de la Directive Européenne 2014/53/EU.

Dieses Produkt entspricht den Bestimmungen der Europäischen Richtlinie 2014/53/EU.

Þessi vara stenst reglugerð Evrópska Efnahags Bandalagsins númer 2014/53/EU.

Questo prodotto è conforme alla Direttiva Europea 2014/53/EU.

Dette produktet er i henhold til bestemmelsene i det europeiske direktivet 2014/53/EU.

Este produto cumpre com as normas da Diretiva Europeia 2014/53/EU.

Este producto cumple con las normas del Directivo Europeo 2014/53/EU.

Denna produkt har tillverkats i enlighet med EG-direktiv 2014/53/EU.

This declaration is based upon compliance of the Class A products listed above to the following standards:

EN 55032 (CISPR 32 Class A) RF Emissions Control

EN 55035:2017 (CISPR 35) Electromagnetic compatibility of multimedia equipment – Immunity requirements

EN 62368-1, 2nd Edition, 2014/A11:2017 *Information technology equipment – Safety, Part 1: General Requirements*

EN 50581:2012 - Technical documentation for the assessment of electrical and electronic products with respect to the restriction of hazardous substances.

 **CAUTION!** *In a domestic environment, Class A products could cause radio interference, in which case the user may be required to take adequate measures.*

 **ATTENTION!** *Dans un environnement domestique, les produits de Classe A peuvent causer des interférences radio, auquel cas l'utilisateur peut être tenu de prendre des mesures adéquates.*

 **VORSICHT!** *In einer häuslichen Umgebung können Produkte der Klasse A Funkstörungen verursachen. In diesem Fall muss der Benutzer möglicherweise geeignete Maßnahmen ergreifen.*

Responsible Party

Xilinx, Inc.
2100 Logic Drive, San Jose, CA 95124
United States of America
Phone: (408) 559-7778

References

These documents provide supplemental material useful with this guide:

1. *Kria KV260 Vision AI Starter Kit User Guide* ([UG1089](#))
2. *Kria K26 SOM Data Sheet* ([DS987](#))
3. *Kria SOM Carrier Card Design Guide* ([UG1091](#))

Revision History

The following table shows the revision history for this document.

Section	Revision Summary
4/20/2021 Version 1.0	
Initial release.	N/A

Please Read: Important Legal Notices

The information disclosed to you hereunder (the "Materials") is provided solely for the selection and use of Xilinx products. To the maximum extent permitted by applicable law: (1) Materials are made available "AS IS" and with all faults, Xilinx hereby DISCLAIMS ALL WARRANTIES AND CONDITIONS, EXPRESS, IMPLIED, OR STATUTORY, INCLUDING BUT NOT LIMITED TO WARRANTIES OF MERCHANTABILITY, NON-INFRINGEMENT, OR FITNESS FOR ANY PARTICULAR PURPOSE; and (2) Xilinx shall not be liable (whether in contract or tort, including negligence, or under any other theory of liability) for any loss or damage of any kind or nature related to, arising under, or in connection with, the Materials (including your use of the Materials), including for any direct, indirect, special, incidental, or consequential loss or damage (including loss of data, profits, goodwill, or any type of loss or damage suffered as a result of any action brought by a third party) even if such damage or loss was reasonably foreseeable or Xilinx had been advised of the possibility of the same. Xilinx assumes no obligation to correct any errors contained in the Materials or to notify you of updates to the Materials or to product specifications. You may not reproduce, modify, distribute, or publicly display the Materials without prior written consent. Certain products are subject to the terms and conditions of Xilinx's limited warranty, please refer to Xilinx's Terms of Sale which can be viewed at <https://www.xilinx.com/legal.htm#tos>; IP cores may be subject to warranty and support terms contained in a license issued to you by Xilinx. Xilinx products are not designed or intended to be fail-safe or for use in any application requiring fail-safe performance; you assume sole risk and liability for use of Xilinx products in such critical applications, please refer to Xilinx's Terms of Sale which can be viewed at <https://www.xilinx.com/legal.htm#tos>.

AUTOMOTIVE APPLICATIONS DISCLAIMER

AUTOMOTIVE PRODUCTS (IDENTIFIED AS "XA" IN THE PART NUMBER) ARE NOT WARRANTED FOR USE IN THE DEPLOYMENT OF AIRBAGS OR FOR USE IN APPLICATIONS THAT AFFECT CONTROL OF A VEHICLE ("SAFETY APPLICATION") UNLESS THERE IS A SAFETY CONCEPT OR REDUNDANCY FEATURE CONSISTENT WITH THE ISO 26262 AUTOMOTIVE SAFETY STANDARD ("SAFETY DESIGN"). CUSTOMER SHALL, PRIOR TO USING OR DISTRIBUTING ANY SYSTEMS THAT INCORPORATE PRODUCTS, THOROUGHLY TEST SUCH SYSTEMS FOR SAFETY PURPOSES. USE OF PRODUCTS IN A SAFETY APPLICATION WITHOUT A SAFETY DESIGN IS FULLY AT THE RISK OF CUSTOMER, SUBJECT ONLY TO APPLICABLE LAWS AND REGULATIONS GOVERNING LIMITATIONS ON PRODUCT LIABILITY.

Copyright

© Copyright 2021 Xilinx, Inc. Xilinx, the Xilinx logo, Alveo, Artix, Kintex, Spartan, Versal, Virtex, Vivado, Zynq, and other designated brands included herein are trademarks of Xilinx in the United States and other countries. All other trademarks are the property of their respective owners.